

## Current Regulator Diodes

<b>J500</b>	<b>J503</b>	<b>J506</b>	<b>J509</b>
<b>J501</b>	<b>J504</b>	<b>J507</b>	<b>J510</b>
<b>J502</b>	<b>J505</b>	<b>J508</b>	<b>J511</b>

PRODUCT SUMMARY					
Part Number	Typ I <sub>F</sub> (mA)	P <sub>OV</sub> (V)	Part Number	Typ I <sub>F</sub> (mA)	P <sub>OV</sub> (V)
J500	0.24	50	J506	1.40	50
J501	0.33	50	J507	1.80	50
J502	0.43	50	J508	2.40	50
J503	0.56	50	J509	3.00	50
J504	0.75	50	J510	3.60	50
J505	1.00	50	J511	4.70	50

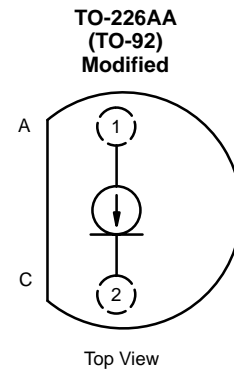

### FEATURES

- Two-Lead Plastic Package
- Guaranteed  $\pm 20\%$  Tolerance
- Operation from 1 V (J500–J503) to 50 V
- Excellent Temperature Stability

### BENEFITS

- Simple Series Circuitry, No Separate Voltage Source
- Tight Guaranteed Circuit Performance
- Excellent Performance in Low-Voltage/Battery Circuits and High-Voltage Spike Protection
- High Circuit Stability vs. Temperature

### APPLICATIONS

- Constant-Current Supply
- Current-Limiting
- Timing Circuits

### DESCRIPTION

The J500 series is a family of  $\pm 20\%$  range current regulators designed for demanding applications in test equipment and instrumentation. These devices utilize the JFET techniques to produce a single two-leaded device which is extremely simple to operate.

With nominal current ranges from 0.24 mA to 4.7 mA, the J500 series will meet a wide array of design requirements.

The low-cost TO-226A package ensures a cost-effective design solution.

### SCHEMATIC DIAGRAM

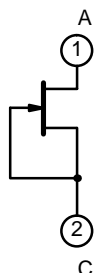

### APPLICATIONS

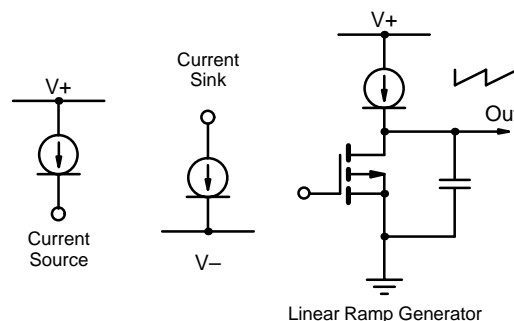

For applications information see AN103.



### ABSOLUTE MAXIMUM RATINGS

Peak Operating Voltage ..... 50 V  
 Reverse Current ..... 50 mA  
 Storage Temperature ..... -55 to 150°C

Power Dissipation<sup>a</sup> ..... 350 mW

Notes:

a. Derate 2.8 mW/°C above 25°C

SPECIFICATIONS (T <sub>A</sub> = 25°C UNLESS OTHERWISE NOTED)						
Parameter	Symbol	Test Conditions	Limits			Unit
			Min	Typ <sup>a</sup>	Max	
Peak Operating Voltage <sup>b</sup>	P <sub>OV</sub>	I <sub>F</sub> = 1.1 I <sub>F(max)</sub>	50	95		V
Reverse Voltage	V <sub>R</sub>	I <sub>R</sub> = 1 mA		0.8		
Capacitance	C <sub>F</sub>	V <sub>F</sub> = 25 V, f = 1 MHz		2.2		pF

Part Number	Regulator Current <sup>c</sup> (I <sub>F</sub> )			Dynamic Impedance <sup>d</sup> (Z <sub>d</sub> )		Knee Impedance (Z <sub>k</sub> )	Limiting Voltage <sup>e</sup> (V <sub>L</sub> )		Temperature Coefficient (θ <sub>1</sub> )
	V <sub>F</sub> = 25 V			V <sub>F</sub> = 25 V		V <sub>F</sub> = 6 V	I <sub>F</sub> = 0.8 I <sub>F(min)</sub>		V <sub>F</sub> = 25 V 0°C ≤ T <sub>A</sub> ≤ 100°C
	Min	Nom	Max	Min	Typ <sup>a</sup>	Typ <sup>a</sup>	Max	Typ <sup>a</sup>	Typ <sup>a</sup>
J500	0.192	0.24	0.288	4.00	15	2.50	1.2	0.4	0.95
J501	0.264	0.33	0.396	2.20	10	1.60	1.3	0.5	0.81
J502	0.344	0.43	0.516	1.50	7	1.10	1.5	0.6	0.70
J503	0.448	0.56	0.672	1.20	5	0.80	1.7	0.7	0.58
J504	0.600	0.75	0.900	0.80	3.5	0.55	1.9	0.8	0.46
J505	0.800	1.00	1.200	0.50	2	0.40	2.1	0.9	0.33
J506	1.120	1.40	1.680	0.33	1.5	0.25	2.5	1.1	0.19
J507	1.440	1.80	2.160	0.20	1	0.19	2.8	1.3	0.08
J508	1.900	2.40	2.900	0.20	0.7	0.13	3.1	1.5	-0.05
J509	2.400	3.00	3.600	0.15	0.5	0.09	3.5	1.7	-0.14
J510	2.900	3.60	4.300	0.15	0.4	0.07	3.9	1.9	-0.22
J511	3.800	4.70	5.600	0.12	0.3	0.05	4.2	2.1	-0.34

Notes:

- Typical values are for DESIGN AID ONLY, not guaranteed nor subject to production testing.
- Max V<sub>F</sub> where I<sub>F</sub> = 1.1 I<sub>F(max)</sub> is guaranteed.
- Pulse test—steady state currents may vary.
- Pulse test—steady state impedances may vary.
- Min V<sub>F</sub> required to insure I<sub>F</sub> = 0.8 I<sub>F(min)</sub>.

NCL



**TYPICAL CHARACTERISTICS ( $T_A = 25^\circ\text{C}$  UNLESS OTHERWISE NOTED)**

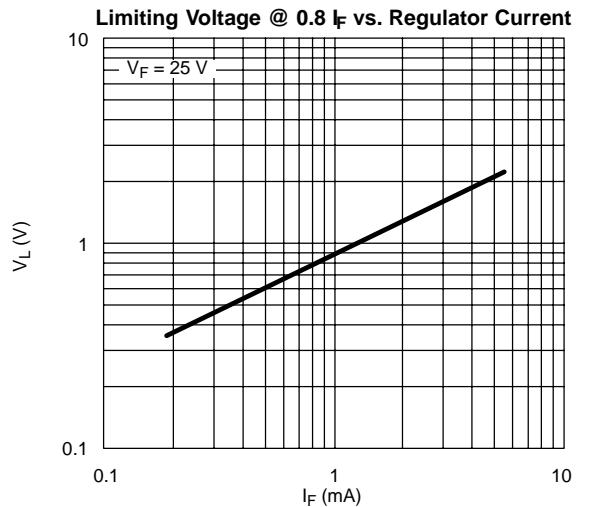
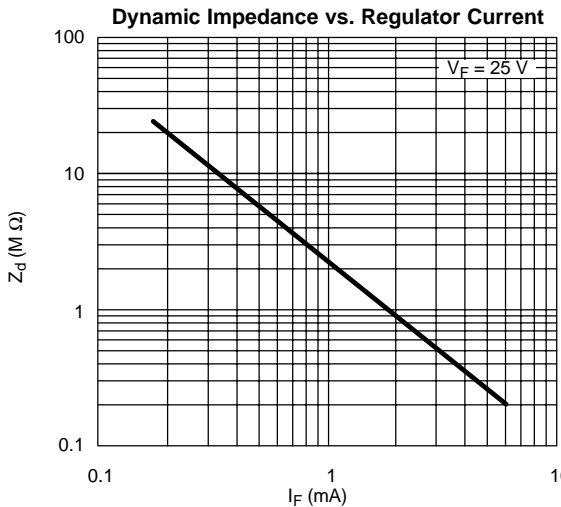
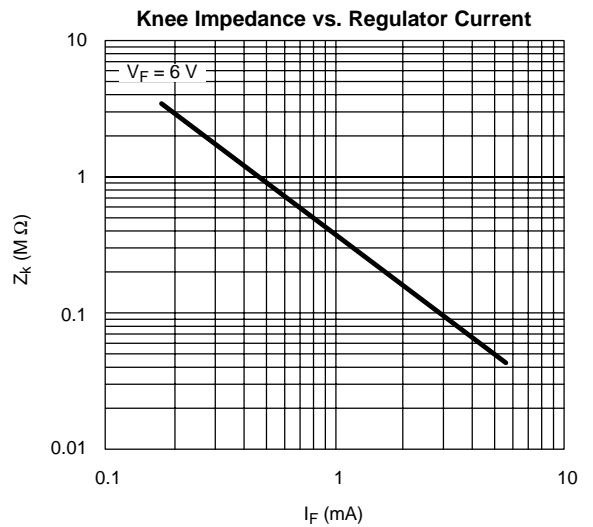
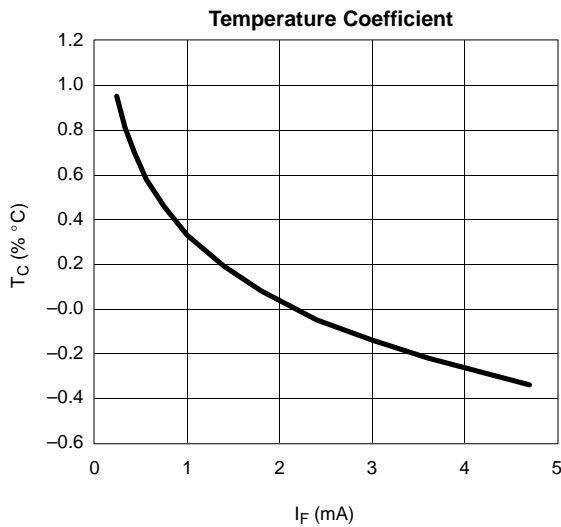
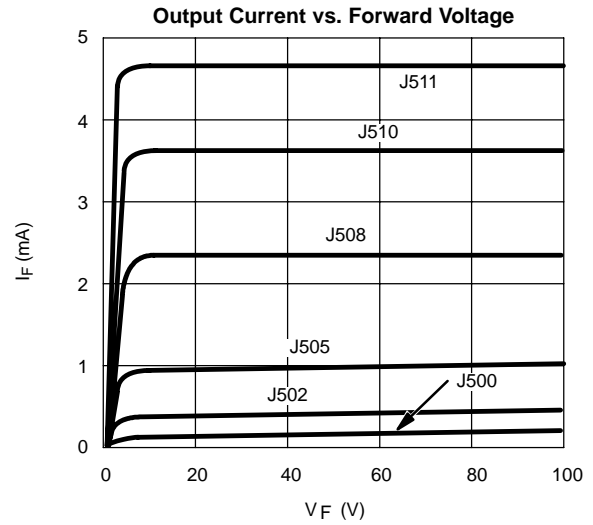
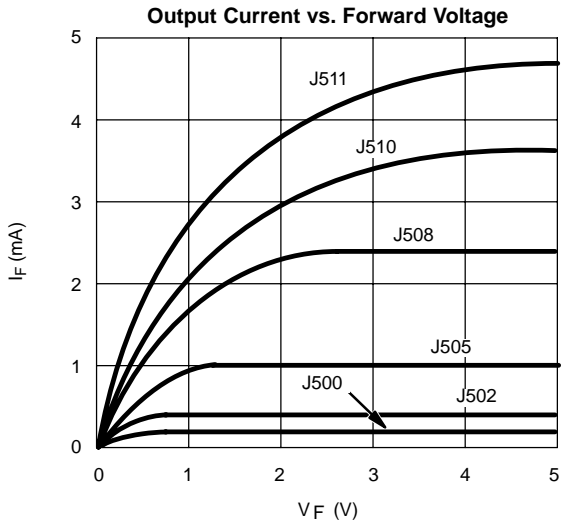

**TYPICAL CHARACTERISTICS ( $T_A = 25^\circ\text{C}$  UNLESS OTHERWISE NOTED)**

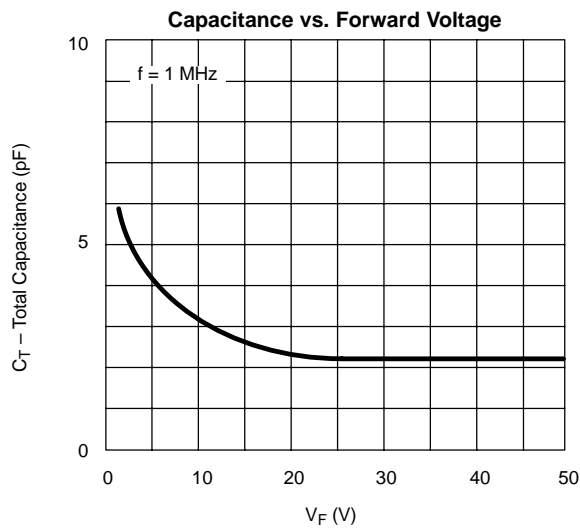
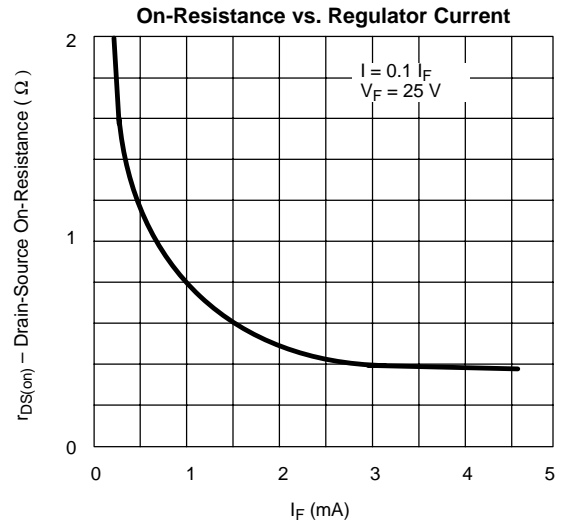
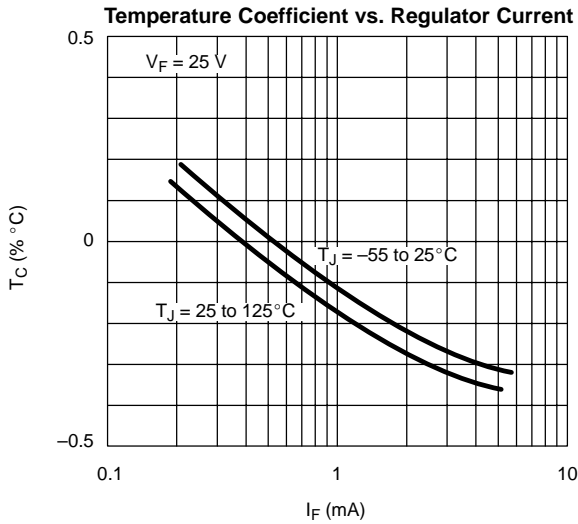

**CURRENT REGULATOR DIODE V-1 CHARACTERISTIC**

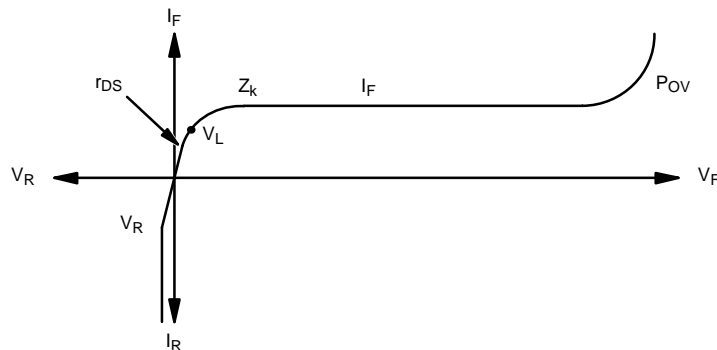



## Notice

Specifications of the products displayed herein are subject to change without notice. Vishay Intertechnology, Inc., or anyone on its behalf, assumes no responsibility or liability for any errors or inaccuracies.

Information contained herein is intended to provide a product description only. No license, express or implied, by estoppel or otherwise, to any intellectual property rights is granted by this document. Except as provided in Vishay's terms and conditions of sale for such products, Vishay assumes no liability whatsoever, and disclaims any express or implied warranty, relating to sale and/or use of Vishay products including liability or warranties relating to fitness for a particular purpose, merchantability, or infringement of any patent, copyright, or other intellectual property right.

The products shown herein are not designed for use in medical, life-saving, or life-sustaining applications. Customers using or selling these products for use in such applications do so at their own risk and agree to fully indemnify Vishay for any damages resulting from such improper use or sale.