

TLV4110, TLV4111, TLV4112, TLV4113 FAMILY OF HIGH OUTPUT DRIVE OPERATIONAL AMPLIFIERS WITH SHUTDOWN

SLOS289A – DECEMBER 1999 – REVISED APRIL 2000

- High Output Drive . . . >300 mA
- Rail-To-Rail Output
- Unity-Gain Bandwidth . . . 2 MHz
- Slew Rate . . . 1.5 V/ μ s
- Supply Current . . . 700- μ A/Per Channel
- Supply Voltage Range . . . 2.5 V to 6 V
- Specified Temperature Range:
 - $T_A = 0^\circ\text{C}$ to 70°C . . . Commercial Grade
 - $T_A = -40^\circ\text{C}$ to 125°C . . . Industrial Grade
- Universal OpAmp EVM

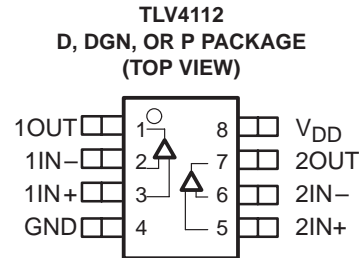

description

The TLV411x single supply operational amplifiers provide output currents in excess of 300 mA at 5 V. This enables standard pin-out amplifiers to be used as high current buffers or in coil driver applications. The TLV4110 and TLV4113 comes with a shutdown feature.

The TLV411x is available in the ultra small MSOP PowerPAD™ package, which offers the exceptional thermal impedance required for amplifiers delivering high current levels.

All TLV411x devices are offered in PDIP, SOIC (single and dual) and MSOP PowerPAD (dual).

FAMILY PACKAGE TABLE

DEVICE	NUMBER OF CHANNELS	PACKAGE TYPES			SHUTDOWN	UNIVERSAL EVM BOARD
		MSOP	PDIP	SOIC		
TLV4110†	1	8	8	8	Yes	Refer to the EVM Selection Guide (Lit# SLOU060)
TLV4111†	1	8	8	8	—	
TLV4112	2	8	8	8	—	
TLV4113†	2	10	14	14	Yes	

† This device is in the Product Preview stage of development. Contact the local TI sales office for more information.

HIGH-LEVEL OUTPUT VOLTAGE
vs
HIGH-LEVEL OUTPUT CURRENT

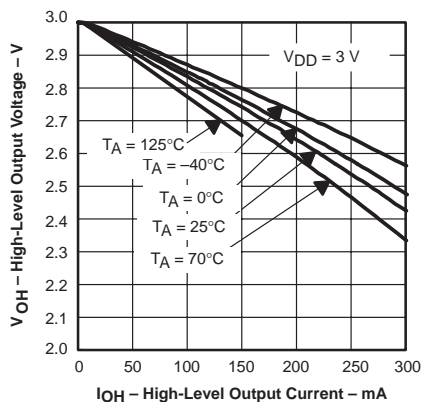

LOW-LEVEL OUTPUT VOLTAGE
vs
LOW-LEVEL OUTPUT CURRENT

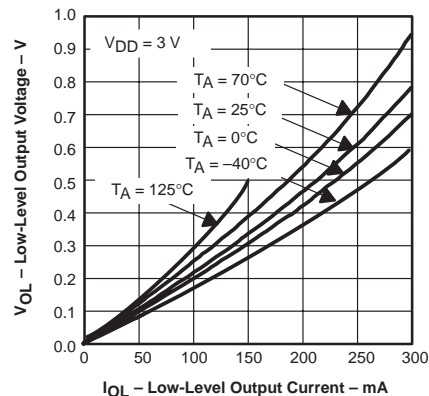

Please be aware that an important notice concerning availability, standard warranty, and use in critical applications of Texas Instruments semiconductor products and disclaimers thereto appears at the end of this data sheet.

PowerPAD is a trademark of Texas Instruments.

PRODUCTION DATA information is current as of publication date. Products conform to specifications per the terms of Texas Instruments standard warranty. Production processing does not necessarily include testing of all parameters.

**TEXAS
INSTRUMENTS**

POST OFFICE BOX 655303 • DALLAS, TEXAS 75265

Copyright © 2000, Texas Instruments Incorporated

TLV4110, TLV4111, TLV4112, TLV4113 FAMILY OF HIGH OUTPUT DRIVE OPERATIONAL AMPLIFIERS WITH SHUTDOWN

SLOS289A – DECEMBER 1999 – REVISED APRIL 2000

TLV4110 AND TLV4111 AVAILABLE OPTIONS

T _A	PACKAGED DEVICES			
	SMALL OUTLINE (D)†‡	SMALL OUTLINE (DGN)†	SYMBOL	PLASTIC DIP (P)
0°C to 70°C	TLV4110CD	TLV4110CDGN	xxTIAHL	TLV4110CP
	TLV4111CD	TLV4111CDGN	xxTIAHN	TLV4111CP
-40°C to 125°C	TLV4110ID	TLV4110IDGN	xxTIAHM	TLV4110IP
	TLV4111ID	TLV4111IDGN	xxTIAHO	TLV4111IP

† This package is available taped and reeled. To order this packaging option, add an R suffix to the part number (e.g., TLV4110CDR).

‡ In the SOIC package, the maximum RMS output power is thermally limited to 350 mW; 700 mW peaks can be driven, as long as the RMS value is less than 350 mW.

TLV4112 AND TLV4113 AVAILABLE OPTIONS

T _A	PACKAGED DEVICES					
	SMALL OUTLINE (D)†§	SMALL OUTLINE (DGN)†	SYMBOL	SMALL OUTLINE (DGQ)†	SYMBOL	PLASTIC DIP (P)
0°C to 70°C	TLV4112CD	TLV4112DGN	xxTIAHP	—	—	TLV4112CP
	TLV4113CD‡	—	—	TLV4113CDGN‡	xxTIAHR	TLV4113CN‡
-40°C to 125°C	TLV4112ID	TLV4112IDGN	xxTIAHQ	—	—	TLV4112IP
	TLV4113ID‡	—	—	TLV4113IDGN‡	xxTIAHS	TLV4113IN‡

† This package is available taped and reeled. To order this packaging option, add an R suffix to the part number (e.g., TLV4112CDR).

‡ This device is in the Product Preview stage of development. Contact the local TI sales office for more information.

§ In the SOIC package, the maximum RMS output power is thermally limited to 350 mW; 700 mW peaks can be driven, as long as the RMS value is less than 350 mW.

TLV411x PACKAGE PINOUTS

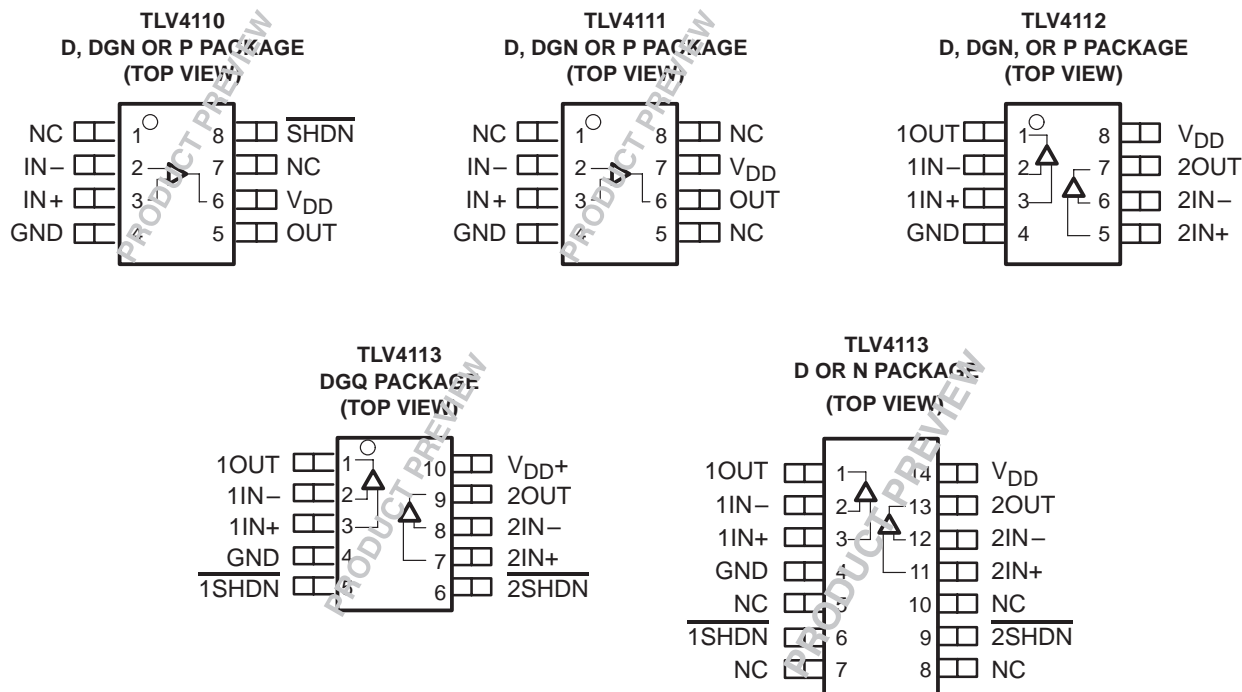

NC – No internal connection

TLV4110, TLV4111, TLV4112, TLV4113 FAMILY OF HIGH OUTPUT DRIVE OPERATIONAL AMPLIFIERS WITH SHUTDOWN

SLOS289A – DECEMBER 1999 – REVISED APRIL 2000

absolute maximum ratings over operating free-air temperature range (unless otherwise noted)†

Supply voltage, V_{DD} (see Note 1)	7 V
Differential input voltage, V_{ID}	$\pm V_{DD}$
Input voltage range, V_I	$\pm V_{DD}$
Output current, I_O (see Note 2)	800 mA
Continuous /RMS output current, I_O (each output of amplifier):	
$T_J \leq 105^\circ\text{C}$	350 mA
$T_J \leq 150^\circ\text{C}$	110 mA
Peak output current, I_O (each output of amplifier):	
$T_J \leq 105^\circ\text{C}$	500 mA
$T_J \leq 150^\circ\text{C}$	155 mA
Continuous total power dissipation	See Dissipation Rating Table
Operating free-air temperature range, T_A : C suffix	0°C to 70°C
I suffix	-40°C to 125°C
Maximum junction temperature, T_J	150°C
Storage temperature range, T_{stg}	-65°C to 150°C
Lead temperature 1,6 mm (1/16 inch) from case for 10 seconds	260°C

† Stresses beyond those listed under “absolute maximum ratings” may cause permanent damage to the device. These are stress ratings only, and functional operation of the device at these or any other conditions beyond those indicated under “recommended operating conditions” is not implied. Exposure to absolute-maximum-rated conditions for extended periods may affect device reliability.

- NOTES: 1. All voltage values, except differential voltages, are with respect to GND.
2. To prevent permanent damage the die temperature must not exceed the maximum junction temperature.

DISSIPATION RATING TABLE

PACKAGE	θ_{JC} ($^\circ\text{C}/\text{W}$)	θ_{JA} ($^\circ\text{C}/\text{W}$)	$T_A \leq 25^\circ\text{C}$ POWER RATING
D (8)	38.3	176	710 mW
D (14)	26.9	122.3	1022 mW
DGN (8)‡	4.7	52.7	2.37 W
DGQ (10)‡	4.7	52.3	2.39 W
P (8)	41	104	1200 mW
N (14)	32	78	1600 mW

‡ See The Texas Instruments document, *PowerPAD Thermally Enhanced Package Application Report* (literature number SLMA002), for more information on the PowerPAD package. The thermal data was measured on a PCB layout based on the information in the section entitled *Texas Instruments Recommended Board for PowerPAD* on page 33 of the before mentioned document.

recommended operating conditions

			MIN	MAX	UNIT
Supply voltage, V_{DD}			2.5	6	V
Common-mode input voltage range, V_{ICR}			0	$V_{DD}-1.5$	V
Operating free-air temperature, T_A	C-suffix		0	70	$^\circ\text{C}$
	I-suffix		-40	125	
Shutdown turn on/off voltage level§	V(on)	$V_{DD} = 3\text{ V}$	2.1		V
		$V_{DD} = 5\text{ V}$	3.8		
	V(off)	$V_{DD} = 3\text{ V}$		0.9	
		$V_{DD} = 5\text{ V}$		1.65	

§ Relative to GND



TLV4110, TLV4111, TLV4112, TLV4113

FAMILY OF HIGH OUTPUT DRIVE OPERATIONAL AMPLIFIERS WITH SHUTDOWN

SLOS289A – DECEMBER 1999 – REVISED APRIL 2000

electrical characteristics at recommend operating conditions, $V_{DD} = 3\text{ V}$ and 5 V (unless otherwise noted)

dc performance

PARAMETER		TEST CONDITIONS		T_A^\dagger	MIN	TYP	MAX	UNITS
V_{IO}	Input offset voltage	$V_{IC} = V_{DD}/2,$ $R_L = 100\ \Omega,$	$V_O = V_{DD}/2,$ $R_S = 50\ \Omega$	25°C	175	3500		μV
				Full range		4000		
αV_{IO}	Offset voltage draft			25°C		3		$\mu\text{V}/^\circ\text{C}$
CMRR	Common-mode rejection ratio	$V_{DD} = 3\text{ V},$ $R_S = 50\ \Omega$	$V_{IC} = 0\text{ to }2\text{ V},$	25°C		63		dB
			$V_{IC} = 0\text{ to }4\text{ V},$	25°C		68		
AVD	Large-signal differential voltage amplification	$V_{DD} = 3\text{ V},$ $V_{O(PP)} = 0\text{ to }1\text{ V}$	$R_L = 100\ \Omega$	25°C	78	84		dB
				Full range		67		
			$R_L = 10\text{ k}\Omega$	25°C	85	100		
		Full range			75			
		$V_{DD} = 5\text{ V},$ $V_{O(PP)} = 0\text{ to }3\text{ V}$	$R_L = 100\ \Omega$	25°C	88	94		
				Full range		75		
$R_L = 10\text{ k}\Omega$	25°C		90	110				
	Full range		85					

† Full range is 0°C to 70°C for C suffix and -40°C to 125°C for I suffix. If not specified, full range is -40°C to 125°C.

input characteristics

PARAMETER		TEST CONDITIONS		T_A^\dagger	MIN	TYP	MAX	UNITS	
V_{ICR}	Common-mode input voltage range	Measured over CMRR range, $R_S = 50\ \Omega$	$V_{DD} = 3\text{ V}$	25°C and Full range	0	to	1.5	V	
			$V_{DD} = 5\text{ V}$	25°C and Full range	0	to	3.5		
I_{IO}	Input offset current	$V_{IC} = V_{DD}/2$		25°C		0.3	25	pA	
				Full range	TLV411xC		50		
					TLV411xI		250		
I_{IB}	Input bias current	$V_O = V_{DD}/2,$ $R_S = 50\ \Omega$		25°C		0.3	50	pA	
				Full range	TLV411xC		100		
					TLV411xI		500		
$r_{i(d)}$	Differential input resistance			25°C		1000		G Ω	
C_{IC}	Common-mode input capacitance	$f = 100\text{ Hz}$		25°C		5		pF	

† Full range is 0°C to 70°C for C suffix and -40°C to 125°C for I suffix. If not specified, full range is -40°C to 125°C.



TLV4110, TLV4111, TLV4112, TLV4113
FAMILY OF HIGH OUTPUT DRIVE OPERATIONAL
AMPLIFIERS WITH SHUTDOWN

SLOS289A – DECEMBER 1999 – REVISED APRIL 2000

electrical characteristics at specified free-air temperature, $V_{DD} = 3\text{ V}$ and 5 V (unless otherwise noted) (continued)

output characteristics

PARAMETER	TEST CONDITIONS	T_A †	MIN	TYP	MAX	UNITS		
V_{OH} High-level output voltage	$V_{DD} = 3\text{ V}, V_{IC} = V_{DD}/2$	$I_{OH} = -10\text{ mA}$	25°C	2.7	2.97	V		
			Full range	2.7				
		$I_{OH} = -100\text{ mA}$	25°C	2.6	2.73			
			Full range	2.6				
	$V_{DD} = 5\text{ V}, V_{IC} = V_{DD}/2$	$I_{OH} = -10\text{ mA}$	25°C	4.7	4.96	V		
			Full range	4.7				
		$I_{OH} = -100\text{ mA}$	25°C	4.6	4.76			
			Full range	4.6				
$I_{OH} = -200\text{ mA}$		25°C	4.45	4.6				
		-40°C to 85°C	4.35					
V_{OL} Low-level output voltage	$V_{DD} = 3\text{ V and }5\text{ V}, V_{IC} = V_{DD}/2$	$I_{OL} = 10\text{ mA}$	25°C		0.03	0.1	V	
			Full range			0.1		
		$I_{OL} = 100\text{ mA}$	25°C		0.33	0.4		
			Full range		0.55			
	$V_{DD} = 5\text{ V}, V_{IC} = V_{DD}/2$	$I_{OL} = 200\text{ mA}$	25°C		0.38	0.6		
			-40°C to 85°C			0.7		
		$I_{OL} = 10\text{ mA}$	25°C		±220			mA
			$V_{DD} = 5\text{ V}$	25°C		±320		
I_{OS} Short-circuit output current‡	Sourcing	25°C	800		mA			
	Sinking		800					

† Full range is 0°C to 70°C for C suffix and -40°C to 125°C for I suffix. If not specified, full range is -40°C to 125°C.

‡ When driving output currents in excess of 200 mA, the MSOP PowerPAD package is required for thermal dissipation.

power supply

PARAMETER	TEST CONDITIONS	T_A	MIN	TYP	MAX	UNITS
I_{DD} Supply current (per channel)	$V_O = V_{DD}/2$	25°C		700	1000	μA
		Full range			1500	
K_{SVR} Power supply rejection ratio ($\Delta V_{DD} / \Delta V_{IO}$)	$V_{DD} = 2.7\text{ to }3.3\text{ V},$ No load, $V_{IC} = V_{DD}/2\text{ V}$	25°C	70	82	dB	
		Full range	65			
	$V_{DD} = 4.5\text{ to }5.5\text{ V},$ No load, $V_{IC} = V_{DD}/2\text{ V}$	25°C	70	79		
		Full range	65			

† Full range is 0°C to 70°C for C suffix and -40°C to 125°C for I suffix. If not specified, full range is -40°C to 125°C.



TLV4110, TLV4111, TLV4112, TLV4113

FAMILY OF HIGH OUTPUT DRIVE OPERATIONAL AMPLIFIERS WITH SHUTDOWN

SLOS289A – DECEMBER 1999 – REVISED APRIL 2000

electrical characteristics at specified free-air temperature, $V_{DD} = 3\text{ V}$ and 5 V (unless otherwise noted) (continued)

dynamic performance

PARAMETER		TEST CONDITIONS		T_A^\dagger	MIN	TYP	MAX	UNITS
GBWP	Gain bandwidth product	$R_L = 100\ \Omega$	$C_L = 10\ \text{pF}$	25°C		2.7		MHz
SR	Slew rate at unity gain	$V_{O(pp)} = 2\text{ V}$, $R_L = 100\ \Omega$, $C_L = 10\ \text{pF}$	$V_{DD} = 3\text{ V}$	25°C	0.8	1.57		V/ μs
				Full range	0.55			
			$V_{DD} = 5\text{ V}$	25°C	1	1.57		
				Full range	0.7			
ϕ_M	Phase margin	$R_L = 100\ \Omega$,	$C_L = 10\ \text{pF}$	25°C			66	
	Gain margin						16	
t_s	Settling time	$V(\text{STEP})_{pp} = 1\text{ V}$, $A_V = -1$, $C_L = 10\ \text{pF}$, $R_L = 100\ \Omega$	0.1%	25°C			0.7	μs
			0.01%				1.3	

† Full range is 0°C to 70°C for C suffix and -40°C to 125°C for I suffix. If not specified, full range is -40°C to 125°C.

noise/distortion performance

PARAMETER		TEST CONDITIONS		T_A	MIN	TYP	MAX	UNITS
THD+N	Total harmonic distortion plus noise	$V_{O(pp)} = V_{DD}/2\text{ V}$, $R_L = 100\ \Omega$, $f = 100\ \text{Hz}$	$A_V = 1$	25°C			0.025	
			$A_V = 10$				0.035	
			$A_V = 100$				0.15	
V_n	Equivalent input noise voltage	$f = 100\ \text{Hz}$	$f = 10\ \text{kHz}$	25°C			55	nV/ $\sqrt{\text{Hz}}$
			$f = 10\ \text{kHz}$				10	
I_n	Equivalent input noise current	$f = 1\ \text{kHz}$		25°C			0.31	fA/ $\sqrt{\text{Hz}}$

shutdown characteristics

PARAMETER		TEST CONDITIONS		T_A^\dagger	MIN	TYP	MAX	UNITS
$I_{DD}(\text{SHDN})$	Supply current in shutdown mode (per channel) (TLV4110, TLV4113)	$\overline{\text{SHDN}} = 0\text{ V}$		25°C			TBD	μA
				Full range			TBD	
$t(\text{ON})$	Amplifier turnon time ‡	$R_L = 100\ \Omega$		25°C			TBD	μs
$t(\text{Off})$	Amplifier turnoff time ‡						TBD	

† Full range is 0°C to 70°C for C suffix and -40°C to 125°C for I suffix. If not specified, full range is -40°C to 125°C.

‡ Disable time and enable time are defined as the interval between application of the logic signal to SHDN and the point at which the supply current has reached half its final value.

TLV4110, TLV4111, TLV4112, TLV4113
**FAMILY OF HIGH OUTPUT DRIVE OPERATIONAL
 AMPLIFIERS WITH SHUTDOWN**

SLOS289A – DECEMBER 1999 – REVISED APRIL 2000

TYPICAL CHARACTERISTICS

Table of Graphs

			FIGURE
V_{IO}	Input offset voltage	vs Common-mode input voltage	1, 2
CMRR	Common-mode rejection ratio	vs Frequency	3
V_{OH}	High-level output voltage	vs High-level output current	4, 6
V_{OL}	Low-level output voltage	vs Low-level output current	5, 7
Z_o	Output impedance	vs Frequency	8
I_{DD}	Supply current	vs Supply voltage	9
k_{SVR}	Supply voltage rejection ratio	vs Frequency	10
A_{VD}	Differential voltage amplification and phase	vs Frequency	11
	Gain-bandwidth product	vs Supply voltage	12
SR	Slew rate	vs Supply voltage	13
		vs Temperature	14
	Total harmonic distortion+noise	vs Frequency	15
V_n	Equivalent input voltage noise	vs Frequency	16
	Phase margin	vs Capacitive load	17
	Voltage-follower signal pulse response	vs Time	18, 19
	Inverting large-signal pulse response	vs Time	20, 21
	Small-signal inverting pulse response	vs Time	22
	Crosstalk	vs Frequency	23



TLV4110, TLV4111, TLV4112, TLV4113

FAMILY OF HIGH OUTPUT DRIVE OPERATIONAL AMPLIFIERS WITH SHUTDOWN

SLOS289A – DECEMBER 1999 – REVISED APRIL 2000

TYPICAL CHARACTERISTICS

**INPUT OFFSET VOLTAGE
vs
COMMON-MODE INPUT VOLTAGE**

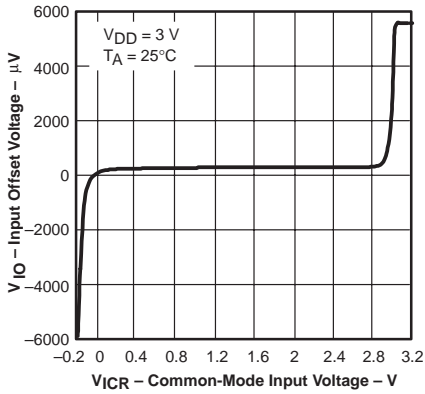

Figure 1

**INPUT OFFSET VOLTAGE
vs
COMMON-MODE INPUT VOLTAGE**

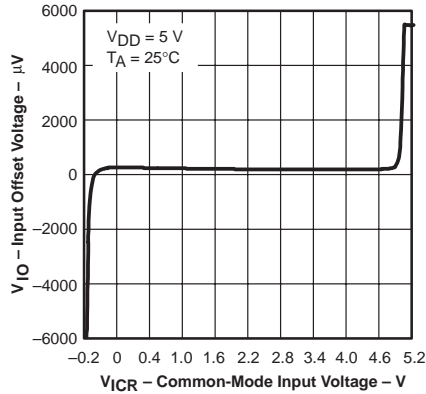

Figure 2

**COMMON-MODE REJECTION RATIO
vs
FREQUENCY**

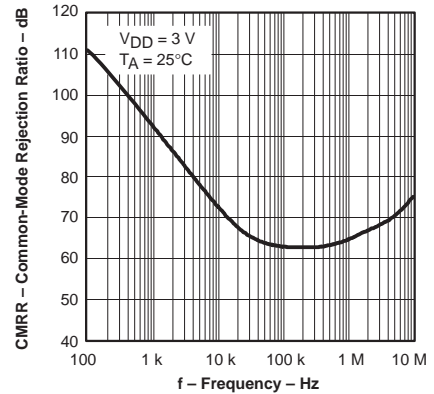

Figure 3

**HIGH-LEVEL OUTPUT VOLTAGE
vs
HIGH-LEVEL OUTPUT CURRENT**

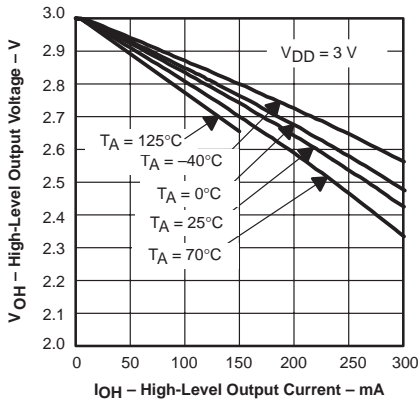

Figure 4

**LOW-LEVEL OUTPUT VOLTAGE
vs
LOW-LEVEL OUTPUT CURRENT**

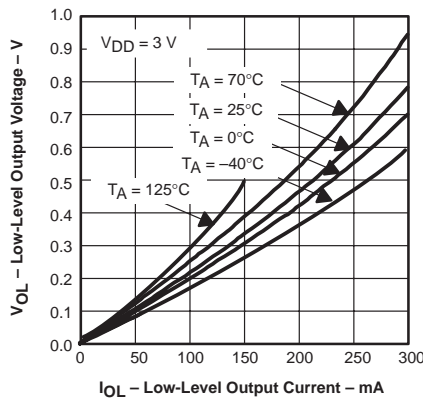

Figure 5

**HIGH-LEVEL OUTPUT VOLTAGE
vs
HIGH-LEVEL OUTPUT CURRENT**

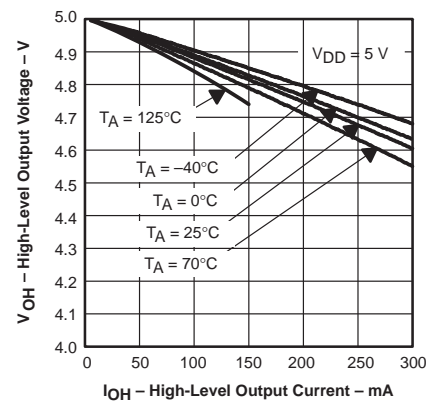

Figure 6

**LOW-LEVEL OUTPUT VOLTAGE
vs
LOW-LEVEL OUTPUT CURRENT**

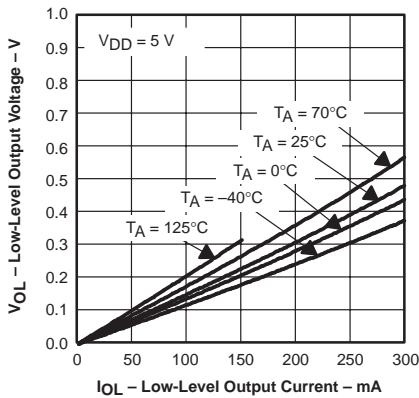

Figure 7

**OUTPUT IMPEDANCE
vs
FREQUENCY**

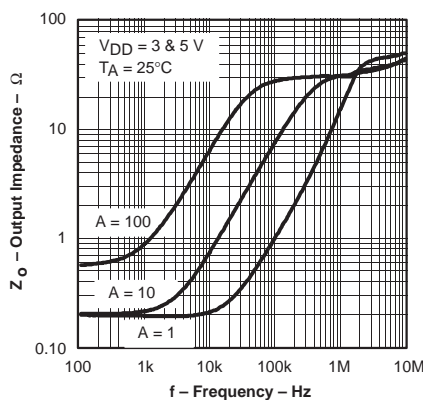

Figure 8

**SUPPLY CURRENT
vs
SUPPLY VOLTAGE**

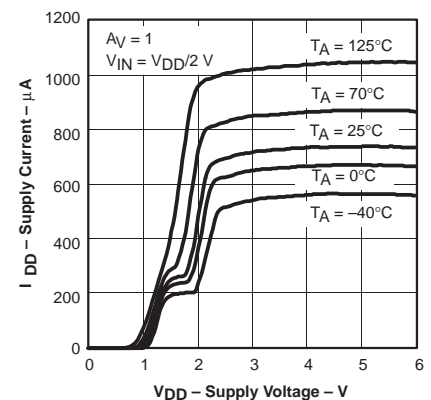

Figure 9



POST OFFICE BOX 655303 • DALLAS, TEXAS 75265

TYPICAL CHARACTERISTICS

SUPPLY VOLTAGE REJECTION RATIO
 VS
 FREQUENCY

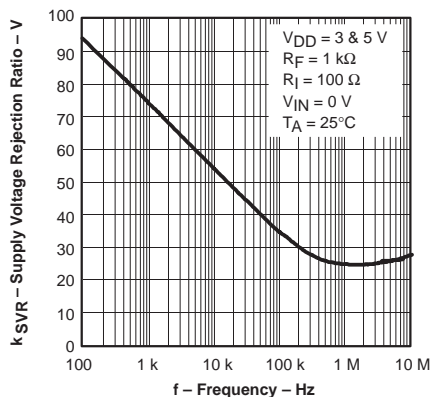

Figure 10

AMPLIFICATION AND PHASE
 VS
 FREQUENCY

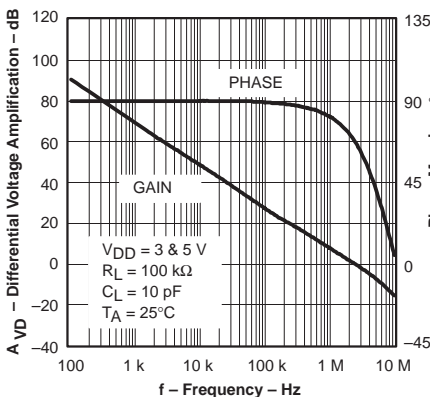

Figure 11

GAIN-BANDWIDTH PRODUCT
 VS
 SUPPLY VOLTAGE

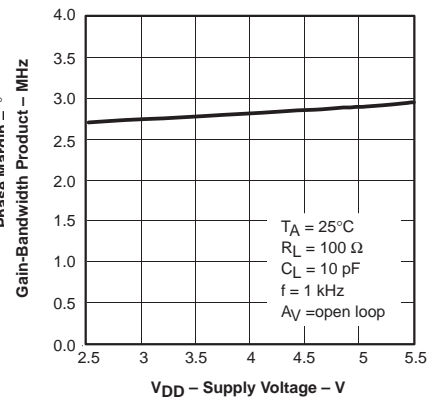

Figure 12

SLEW RATE
 VS
 SUPPLY VOLTAGE

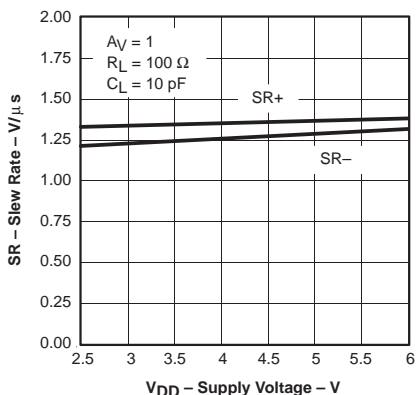

Figure 13

SLEW RATE
 VS
 TEMPERATURE

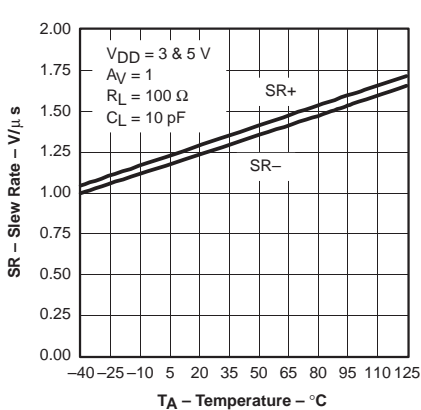

Figure 14

TOTAL HARMONIC DISTORTION+NOISE
 VS
 FREQUENCY

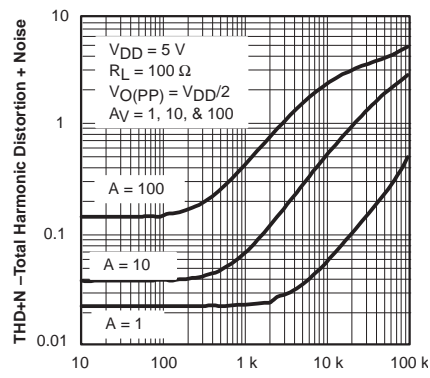

Figure 15

EQUIVALENT INPUT VOLTAGE NOISE
 VS
 FREQUENCY

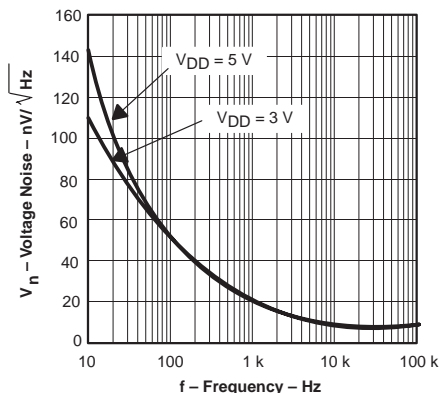

Figure 16

PHASE MARGIN
 VS
 CAPACITIVE LOAD

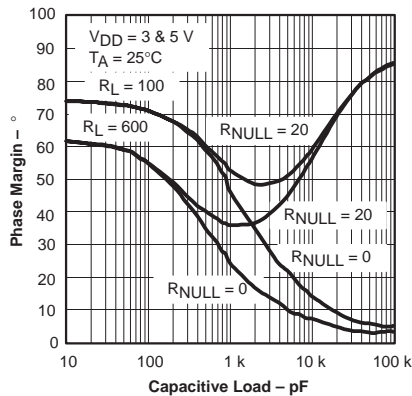

Figure 17

TLV4110, TLV4111, TLV4112, TLV4113
FAMILY OF HIGH OUTPUT DRIVE OPERATIONAL
AMPLIFIERS WITH SHUTDOWN

SLOS289A – DECEMBER 1999 – REVISED APRIL 2000

TYPICAL CHARACTERISTICS

**VOLTAGE-FOLLOWER
 LARGE-SIGNAL PULSE RESPONSE**

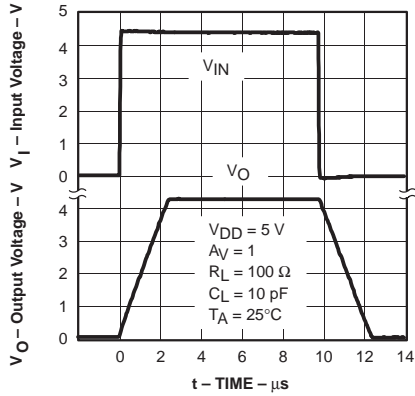

Figure 18

**VOLTAGE-FOLLOWER
 SMALL-SIGNAL PULSE RESPONSE**

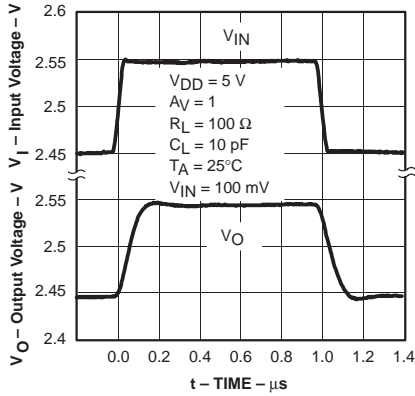

Figure 19

**INVERTING LARGE-SIGNAL
 PULSE RESPONSE**

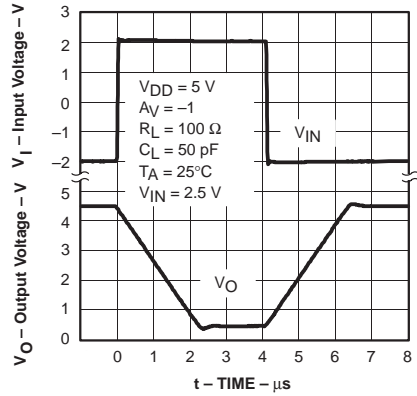

Figure 20

**INVERTING LARGE-SIGNAL
 PULSE RESPONSE**

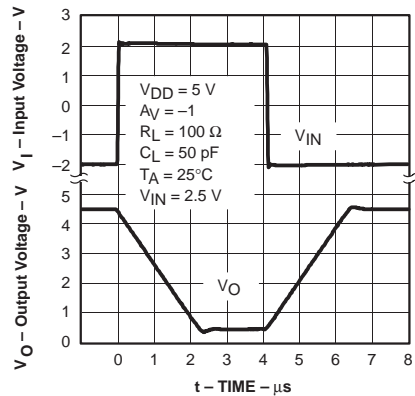

Figure 21

**SMALL-SIGNAL INVERTING
 PULSE RESPONSE**

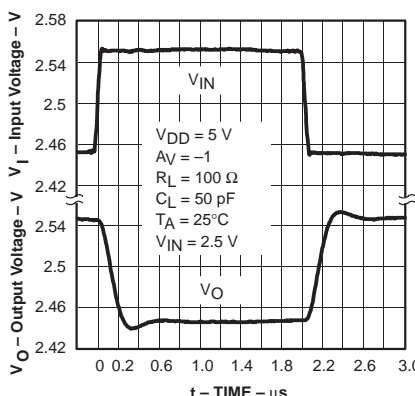

Figure 22

**CROSSTALK
 vs
 FREQUENCY**

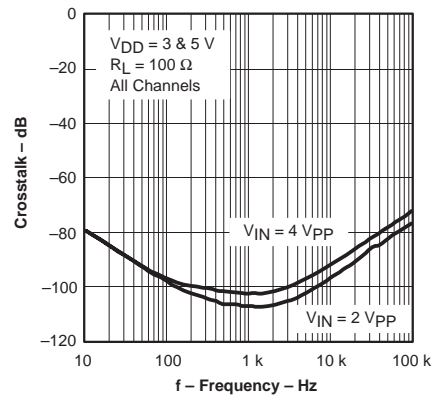

Figure 23



APPLICATION INFORMATION

shutdown function

Two members of the TLV411x family (TLV4110/3) have a shutdown terminal for conserving battery life in portable applications. When the shutdown terminal is tied low, the supply current is reduced to just nano amps per channel, the amplifier is disabled, and the outputs are placed in a high impedance mode. In order to save power in shutdown mode, an external pullup resistor is required, therefore, to enable the amplifier the shutdown terminal must be pulled high. When the shutdown terminal is left floating, care should be taken to ensure that parasitic leakage current at the shutdown terminal does not inadvertently place the operational amplifier into shutdown.

driving a capacitive load

When the amplifier is configured in this manner, capacitive loading directly on the output will decrease the device's phase margin leading to high frequency ringing or oscillations. Therefore, for capacitive loads of greater than 1 nF, it is recommended that a resistor be placed in series (R_{NULL}) with the output of the amplifier, as shown in Figure 24. A maximum value of 20 Ω should work well for most applications.

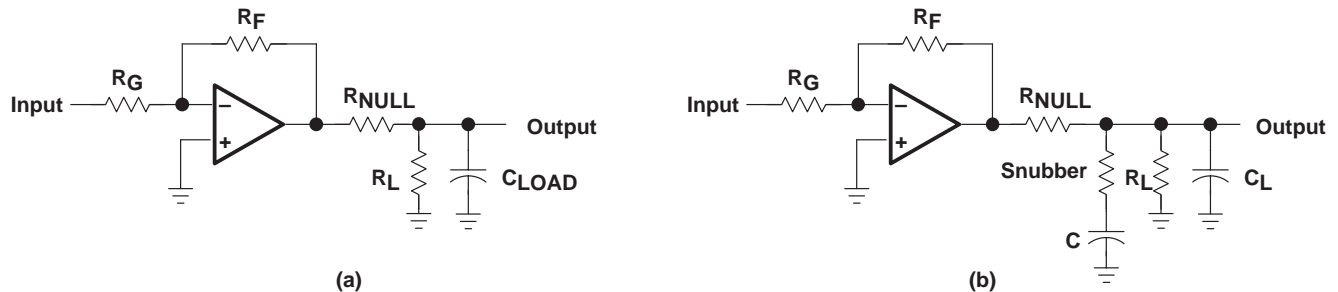

Figure 24. Driving a Capacitive Load

offset voltage

The output offset voltage, (V_{OO}) is the sum of the input offset voltage (V_{IO}) and both input bias currents (I_{IB}) times the corresponding gains. The following schematic and formula can be used to calculate the output offset voltage:

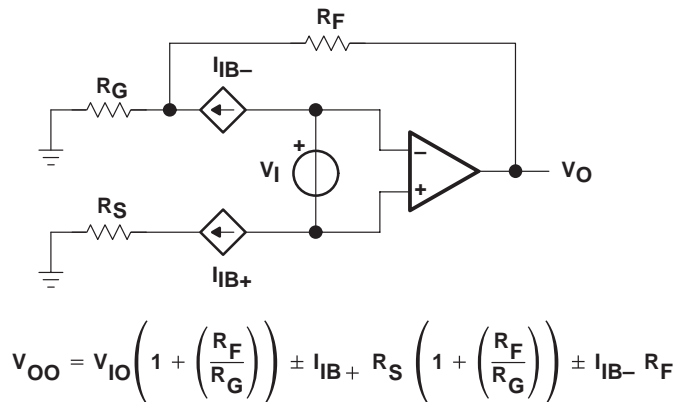

Figure 25. Output Offset Voltage Model

TLV4110, TLV4111, TLV4112, TLV4113
FAMILY OF HIGH OUTPUT DRIVE OPERATIONAL
AMPLIFIERS WITH SHUTDOWN

SLOS289A – DECEMBER 1999 – REVISED APRIL 2000

APPLICATION INFORMATION

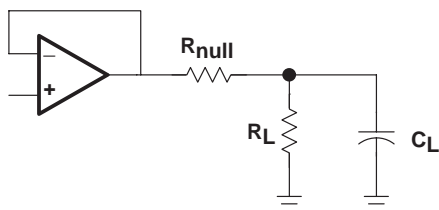

Figure 26

general power design considerations

When driving heavy loads at high junction temperatures there is an increased probability of electromigration affecting the long term reliability of ICs. Therefore for this not to be an issue either

- the output current must be limited (at these high junction temperatures) or
- the junction temperature must be limited.

The maximum continuous output current at a die temperature 150°C will be 1/3 of the current at 105°C.

The junction temperature will be dependent on the ambient temperature around the IC, thermal impedance from the die to the ambient and power dissipated within the IC.

$$T_J = T_A + \theta_{JA} \times P_{DIS}$$

Where

P_{DIS} is the IC power dissipation and is equal to the output current multiplied by the voltage dropped across the output of the IC.

θ_{JA} is the thermal impedance between the junction and the ambient temperature of the IC.

T_J is the junction temperature.

T_A is the ambient temperature.

Reducing one or more of these factors will result in a reduced die temperature. The 8-pin SOIC (small outline integrated circuit) has a thermal impedance from junction to ambient of 176°C/W. For this reason we recommend that the maximum power dissipation of the 8-pin SOIC package be limited to 350 mW, with peak dissipation of 700 mW as long as the RMS value is less than 350 mW.

The use of the MSOP PowerPAD™ dramatically reduces the thermal impedance from junction to case. And with correct mounting, the reduced thermal impedance will greatly increase the IC's permissible power dissipation and output current handling capability. For example, the power dissipation of the PowerPAD™ is increased to above 1 W. Sinusoidal and pulse-width modulated output signals will also increase the output current capability. The equivalent dc current is proportional to the square-root of the duty cycle:

$$I_{DC(EQ)} = I_{Cont} \times \sqrt{\text{duty cycle}}$$

CURRENT DUTY CYCLE AT PEAK RATED CURRENT	EQUIVALENT DC CURRENT AS A PERCENTAGE OF PEAK
100	100
70	84
50	71

Note that with an operational amplifier, a duty cycle of 70% would often result in the op amp sourcing current 70% of the time and sinking current 30%, therefore, the equivalent dc current would still be 0.84 times the continuous current rating at a particular junction temperature.

APPLICATION INFORMATION

general PowerPAD design considerations

The TLV411x is available in a thermally-enhanced PowerPAD family of packages. These packages are constructed using a downset leadframe upon which the die is mounted [see Figure 27(a) and Figure 27(b)]. This arrangement results in the lead frame being exposed as a thermal pad on the underside of the package [see Figure 27(c)]. Because this thermal pad has direct thermal contact with the die, excellent thermal performance can be achieved by providing a good thermal path away from the thermal pad.

The PowerPAD package allows for both assembly and thermal management in one manufacturing operation. During the surface-mount solder operation (when the leads are being soldered), the thermal pad can also be soldered to a copper area underneath the package. Through the use of thermal paths within this copper area, heat can be conducted away from the package into either a ground plane or other heat dissipating device.

The PowerPAD package represents a breakthrough in combining the small area and ease of assembly of surface mount with the, heretofore, awkward mechanical methods of heatsinking.

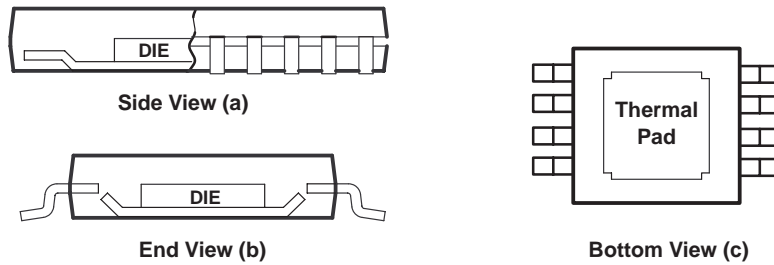

NOTE A: The thermal pad is electrically isolated from all terminals in the package.

Figure 27. Views of Thermally Enhanced DGN Package

Although there are many ways to properly heatsink the PowerPAD package, the following steps illustrate the recommended approach.

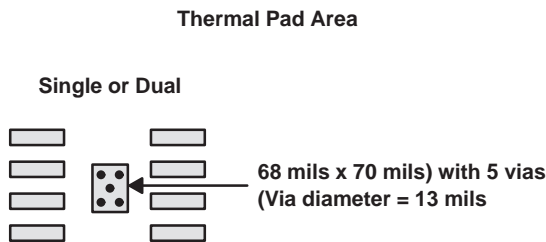

Figure 28. PowerPAD PCB Etch and Via Pattern

TLV4110, TLV4111, TLV4112, TLV4113 FAMILY OF HIGH OUTPUT DRIVE OPERATIONAL AMPLIFIERS WITH SHUTDOWN

SLOS289A – DECEMBER 1999 – REVISED APRIL 2000

APPLICATION INFORMATION

general PowerPAD design considerations (continued)

1. Prepare the PCB with a top side etch pattern as shown in Figure 28. There should be etch for the leads as well as etch for the thermal pad.
2. Place five holes (dual) or nine holes (quad) in the area of the thermal pad. These holes should be 13 mils in diameter. Keep them small so that solder wicking through the holes is not a problem during reflow.
3. Additional vias may be placed anywhere along the thermal plane outside of the thermal pad area. This helps dissipate the heat generated by the TLV411x IC. These additional vias may be larger than the 13-mil diameter vias directly under the thermal pad. They can be larger because they are not in the thermal pad area to be soldered so that wicking is not a problem.
4. Connect all holes to the internal ground plane.
5. When connecting these holes to the ground plane, **do not** use the typical web or spoke via connection methodology. Web connections have a high thermal resistance connection that is useful for slowing the heat transfer during soldering operations. This makes the soldering of vias that have plane connections easier. In this application, however, low thermal resistance is desired for the most efficient heat transfer. Therefore, the holes under the TLV411x PowerPAD package should make their connection to the internal ground plane with a complete connection around the entire circumference of the plated-through hole.
6. The top-side solder mask should leave the terminals of the package and the thermal pad area with its five holes (dual) or nine holes (quad) exposed. The bottom-side solder mask should cover the five or nine holes of the thermal pad area. This prevents solder from being pulled away from the thermal pad area during the reflow process.
7. Apply solder paste to the exposed thermal pad area and all of the IC terminals.
8. With these preparatory steps in place, the TLV411x IC is simply placed in position and run through the solder reflow operation as any standard surface-mount component. This results in a part that is properly installed.

For a given θ_{JA} , the maximum power dissipation is shown in Figure 30 and is calculated by the following formula:

$$P_D = \left(\frac{T_{MAX} - T_A}{\theta_{JA}} \right)$$

Where:

P_D = Maximum power dissipation of TLV411x IC (watts)

T_{MAX} = Absolute maximum junction temperature (150°C)

T_A = Free-ambient air temperature (°C)

θ_{JA} = $\theta_{JC} + \theta_{CA}$

θ_{JC} = Thermal coefficient from junction to case

θ_{CA} = Thermal coefficient from case to ambient air (°C/W)

APPLICATION INFORMATION

general PowerPAD design considerations (continued)

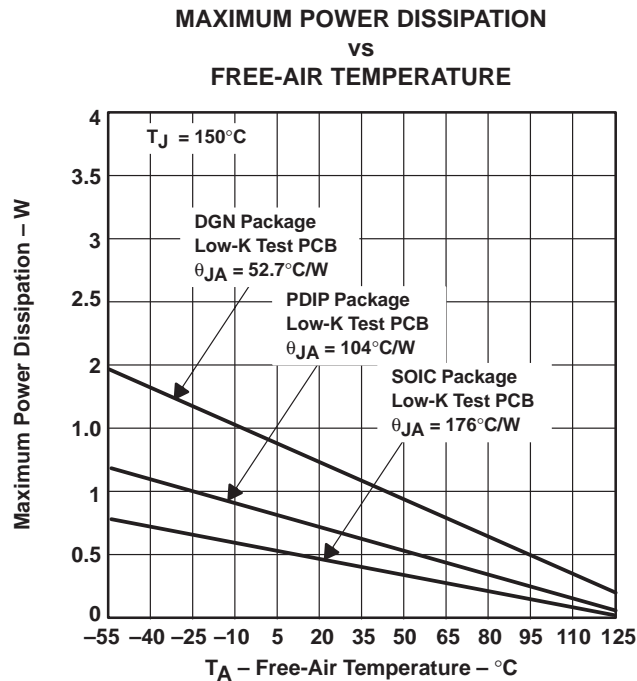

NOTE A: Results are with no air flow and using JEDEC Standard Low-K test PCB.

Figure 29. Maximum Power Dissipation vs Free-Air Temperature

The next consideration is the package constraints. The two sources of heat within an amplifier are quiescent power and output power. The designer should never forget about the quiescent heat generated within the device, especially multi-amplifier devices. Because these devices have linear output stages (Class A-B), most of the heat dissipation is at low output voltages with high output currents.

The other key factor when dealing with power dissipation is how the devices are mounted on the PCB. The PowerPAD devices are extremely useful for heat dissipation. But, the device should always be soldered to a copper plane to fully use the heat dissipation properties of the PowerPAD. The SOIC package, on the other hand, is highly dependent on how it is mounted on the PCB. As more trace and copper area is placed around the device, θ_{JA} decreases and the heat dissipation capability increases. The currents and voltages shown in these graphs are for the total package. For the dual or quad amplifier packages, the sum of the RMS output currents and voltages should be used to choose the proper package.

TLV4110, TLV4111, TLV4112, TLV4113
 FAMILY OF HIGH OUTPUT DRIVE OPERATIONAL
 AMPLIFIERS WITH SHUTDOWN

SLOS289A – DECEMBER 1999 – REVISED APRIL 2000

MECHANICAL DATA

D (R-PDSO-G**)

PLASTIC SMALL-OUTLINE PACKAGE

14 PIN SHOWN

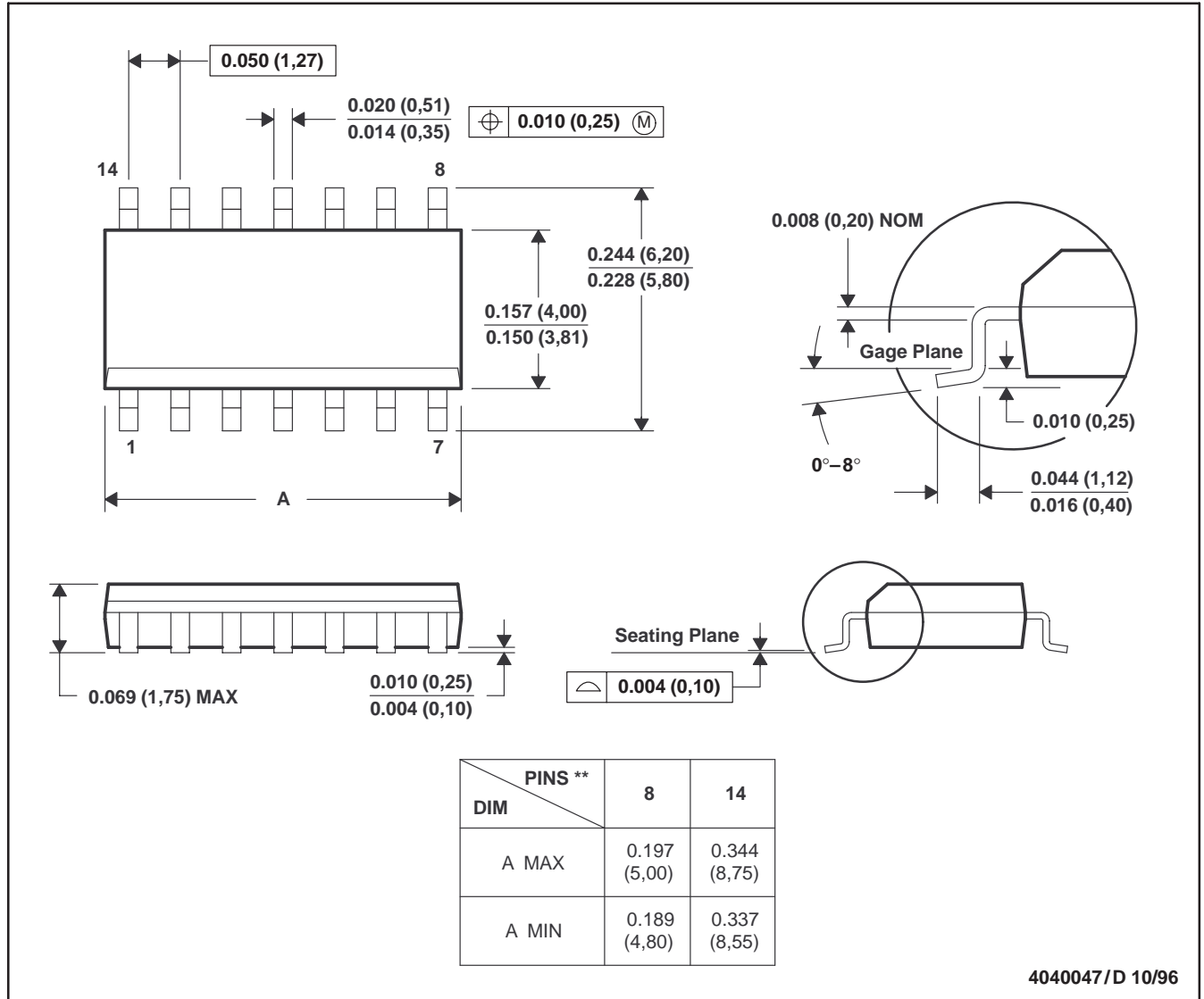

- NOTES: A. All linear dimensions are in inches (millimeters).
 B. This drawing is subject to change without notice.
 C. Body dimensions do not include mold flash or protrusion, not to exceed 0.006 (0,15).
 D. Falls within JEDEC MS-012

TLV4110, TLV4111, TLV4112, TLV4113
FAMILY OF HIGH OUTPUT DRIVE OPERATIONAL
AMPLIFIERS WITH SHUTDOWN

SLOS289A – DECEMBER 1999 – REVISED APRIL 2000

MECHANICAL INFORMATION

DGN (S-PDSO-G8)

PowerPAD™ PLASTIC SMALL-OUTLINE PACKAGE

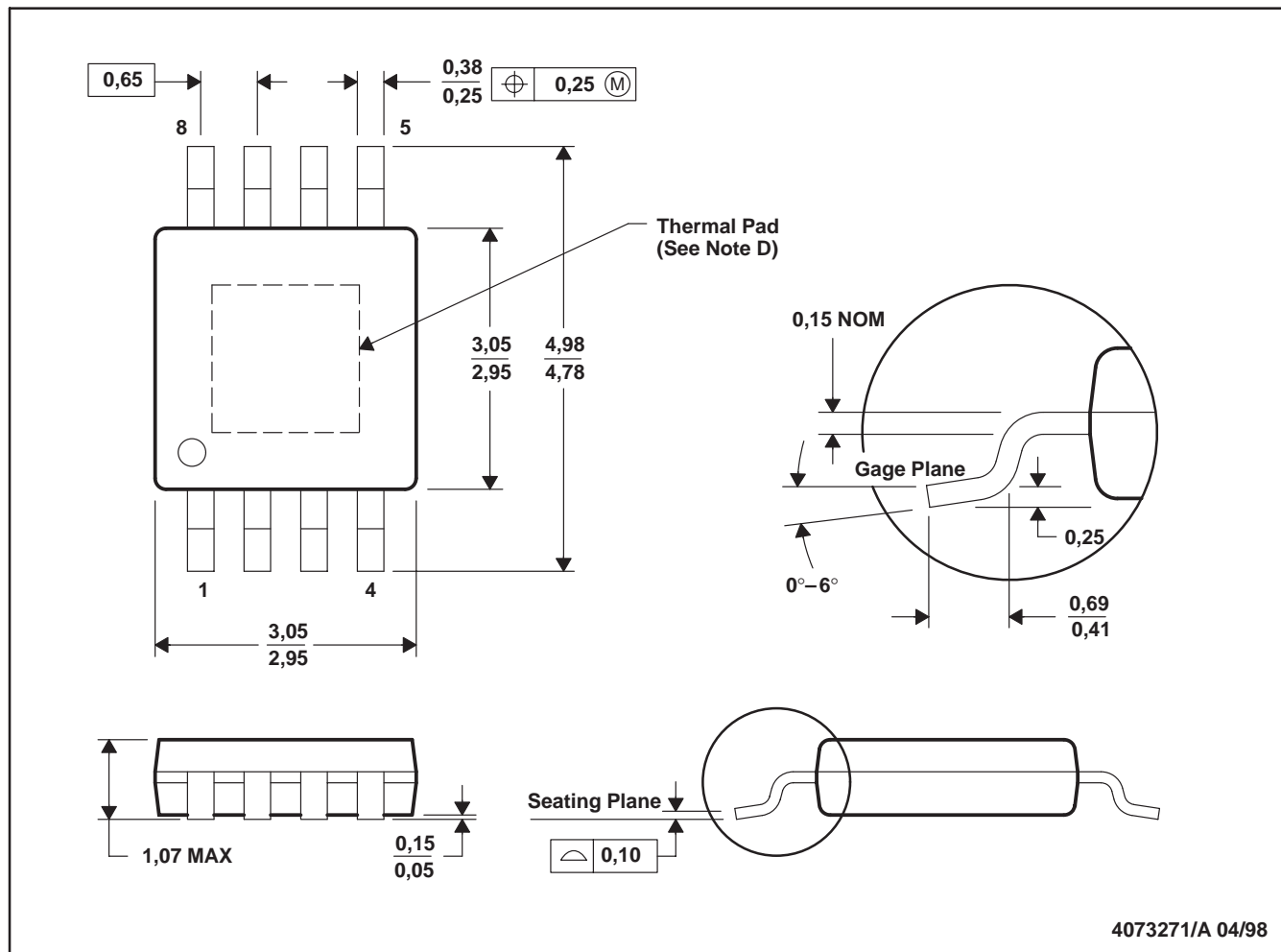

4073271/A 04/98

- NOTES: A. All linear dimensions are in millimeters.
 B. This drawing is subject to change without notice.
 C. Body dimensions include mold flash or protrusions.
 D. The package thermal performance may be enhanced by attaching an external heat sink to the thermal pad. This pad is electrically and thermally connected to the backside of the die and possibly selected leads.
 E. Falls within JEDEC MO-187

PowerPAD is a trademark of Texas Instruments.



POST OFFICE BOX 655303 • DALLAS, TEXAS 75265

TLV4110, TLV4111, TLV4112, TLV4113
 FAMILY OF HIGH OUTPUT DRIVE OPERATIONAL
 AMPLIFIERS WITH SHUTDOWN

SLOS289A – DECEMBER 1999 – REVISED APRIL 2000

MECHANICAL INFORMATION

N (R-PDIP-T**)

PLASTIC DUAL-IN-LINE PACKAGE

16 PIN SHOWN

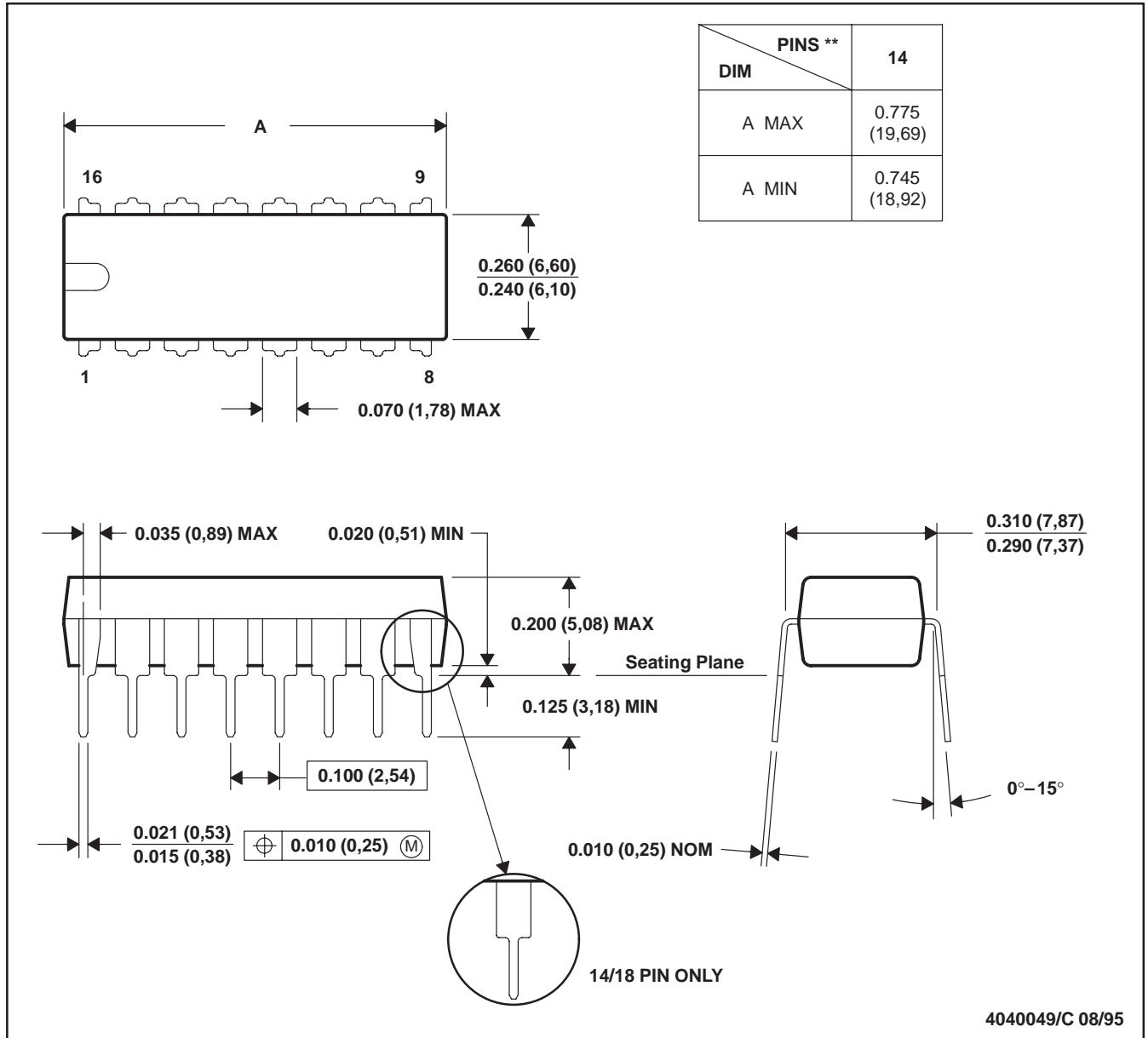

- NOTES: A. All linear dimensions are in inches (millimeters).
 B. This drawing is subject to change without notice.
 C. Falls within JEDEC MS-001 (20 pin package is shorter than MS-001.)

TLV4110, TLV4111, TLV4112, TLV4113
FAMILY OF HIGH OUTPUT DRIVE OPERATIONAL
AMPLIFIERS WITH SHUTDOWN

SLOS289A – DECEMBER 1999 – REVISED APRIL 2000

MECHANICAL INFORMATION

P (R-PDIP-T8)

PLASTIC DUAL-IN-LINE PACKAGE

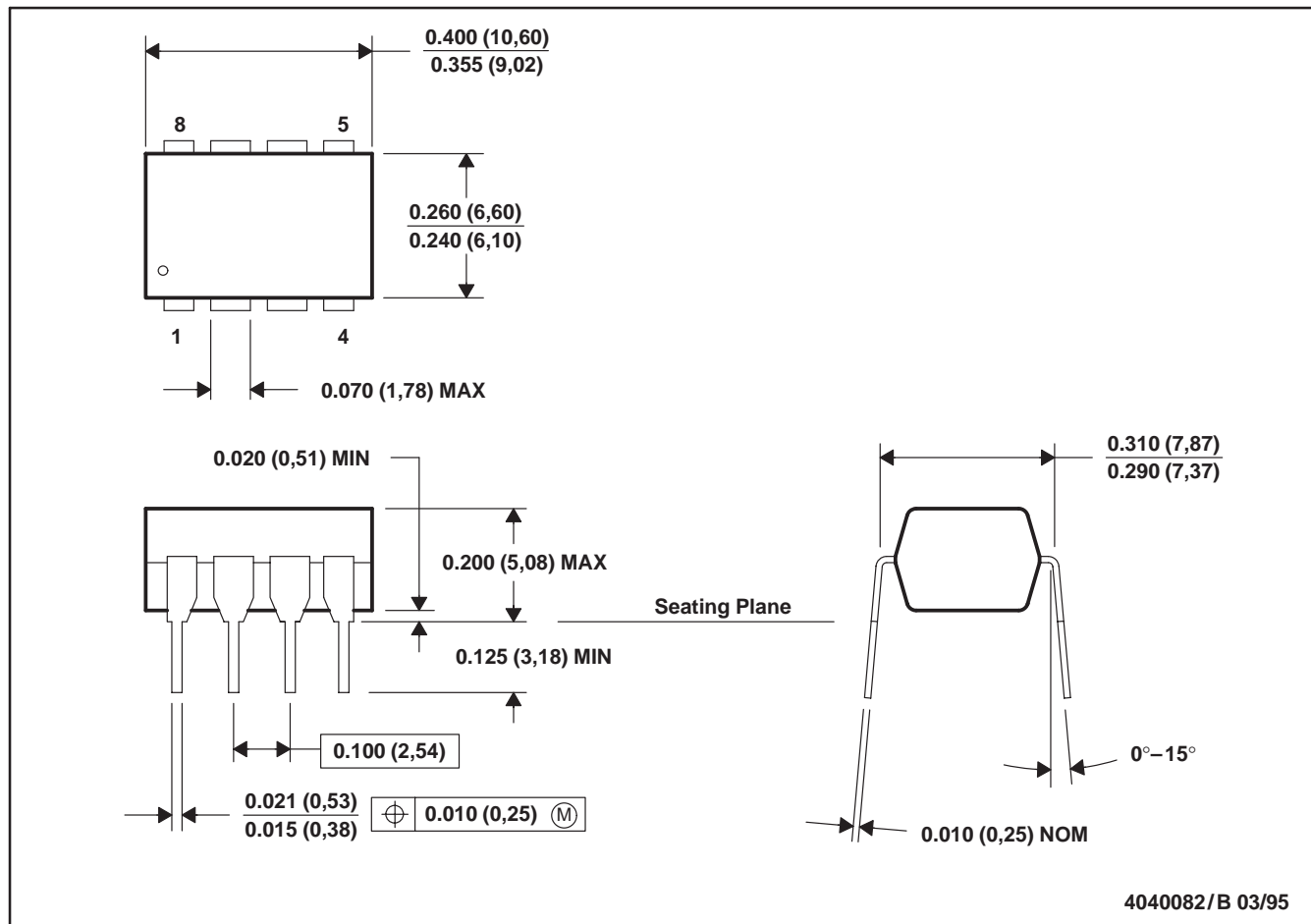

- NOTES: A. All linear dimensions are in inches (millimeters).
 B. This drawing is subject to change without notice.
 C. Falls within JEDEC MS-001

IMPORTANT NOTICE

Texas Instruments and its subsidiaries (TI) reserve the right to make changes to their products or to discontinue any product or service without notice, and advise customers to obtain the latest version of relevant information to verify, before placing orders, that information being relied on is current and complete. All products are sold subject to the terms and conditions of sale supplied at the time of order acknowledgment, including those pertaining to warranty, patent infringement, and limitation of liability.

TI warrants performance of its semiconductor products to the specifications applicable at the time of sale in accordance with TI's standard warranty. Testing and other quality control techniques are utilized to the extent TI deems necessary to support this warranty. Specific testing of all parameters of each device is not necessarily performed, except those mandated by government requirements.

Customers are responsible for their applications using TI components.

In order to minimize risks associated with the customer's applications, adequate design and operating safeguards must be provided by the customer to minimize inherent or procedural hazards.

TI assumes no liability for applications assistance or customer product design. TI does not warrant or represent that any license, either express or implied, is granted under any patent right, copyright, mask work right, or other intellectual property right of TI covering or relating to any combination, machine, or process in which such semiconductor products or services might be or are used. TI's publication of information regarding any third party's products or services does not constitute TI's approval, warranty or endorsement thereof.