

FEATURES

- isoPower* integrated, isolated dc-to-dc converter
- Up to 150 mW output power
- Quad dc to 150 Mbps signal isolation channels
- 24-lead SSOP package with 5.3 mm minimum creepage
- High temperature operation: 105°C
- High common-mode transient immunity: 100 kV/μs
- Safety and regulatory approvals
 - UL recognition (pending)
 - 2500 V rms for 1 minute per UL 1577
 - CSA Component Acceptance Notice 5A (pending)
 - VDE certificate of conformity (pending)
 - DIN V VDE V 0884-10 (VDE V 0884-10):2006-12
 - V_{IORM} = 565 V peak

APPLICATIONS

- RS-232 transceivers
- Power supply startup bias and gate drives
- Isolated sensor interfaces
- Industrial PLCs

GENERAL DESCRIPTION

The ADuM5410/ADuM5411/ADuM5412¹ are quad-channel digital isolators with *isoPower*[®], integrated, isolated dc-to-dc converters. Based on the Analog Devices, Inc., *iCoupler*[®] technology, the dc-to-dc converters provide regulated, isolated power that is adjustable between 3.15 V and 5.25 V. Popular voltage combinations and the associated power levels are shown in Table 1.

The ADuM5410/ADuM5411/ADuM5412 eliminate the need for a separate, isolated dc-to-dc converter in low power, isolated designs. The *iCoupler* chip scale transformer technology is used for isolated logic signals and for the magnetic components of the dc-to-dc converters. The result is a small form factor, total isolation solution.

The ADuM5410/ADuM5411/ADuM5412 isolators provide four independent isolation channels in a variety of channel configurations and data rates (see the Ordering Guide for more information).

FUNCTIONAL BLOCK DIAGRAM

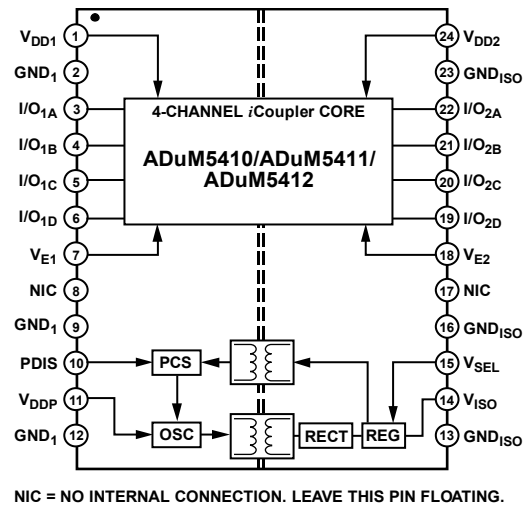

Figure 1.

Table 1. Power Levels

Input Voltage (V)	Output Voltage (V)	Output Power (mW)
5	5	150
5	3.3	100
3.3	3.3	66

Table 2. Data Input/Output Port Assignments

Ch.	Pin No.	ADuM5410	ADuM5411	ADuM5412
I/O1A	3	V _{IA}	V _{IA}	V _{IA}
I/O1B	4	V _{IB}	V _{IB}	V _{IB}
I/O1C	5	V _{IC}	V _{IC}	V _{OC}
I/O1D	6	V _{ID}	V _{OD}	V _{OD}
I/O2A	22	V _{OA}	V _{OA}	V _{OA}
I/O2B	21	V _{OB}	V _{OB}	V _{OB}
I/O2C	20	V _{OC}	V _{OC}	V _{IC}
I/O2D	19	V _{OD}	V _{ID}	V _{ID}

¹ Protected by U.S. Patents 5,952,849; 6,873,065; 6,903,578; and 7,075,329. Other patents are pending.

TABLE OF CONTENTS

Features	1	DIN V VDE V 0884-10 (VDE V 0884-10) Insulation Characteristics	14
Applications.....	1	Recommended Operating Conditions	14
General Description	1	Absolute Maximum Ratings	15
Functional Block Diagram	1	ESD Caution.....	15
Revision History	2	Pin Configurations and Function Descriptions	16
Specifications.....	3	Truth Tables.....	19
Electrical Characteristics—5 V Primary Input Supply/5 V Secondary Isolated Supply.....	3	Typical Performance Characteristics	20
Electrical Characteristics—3.3 V Primary Input Supply/3.3 V Secondary Isolated Supply.....	5	Terminology	24
Electrical Characteristics—5 V Primary Input Supply/3.3 V Secondary Isolated Supply.....	7	Theory of Operation	25
Electrical Characteristics—2.5 V Operation Digital Isolator Channels Only	9	Applications Information	26
Electrical Characteristics—1.8 V Operation Digital Isolator Channels Only	11	PCB Layout	26
Package Characteristics	13	Thermal Analysis	27
Regulatory Approvals.....	13	Propagation Delay Related Parameters	27
Insulation and Safety Related Specifications	13	EMI Considerations	27
		Power Consumption	27
		Insulation Lifetime	27
		Outline Dimensions	29
		Ordering Guide	29

REVISION HISTORY

7/2016—Revision 0: Initial Version

SPECIFICATIONS

ELECTRICAL CHARACTERISTICS—5 V PRIMARY INPUT SUPPLY/5 V SECONDARY ISOLATED SUPPLY

All typical specifications are at $T_A = 25^\circ\text{C}$, $V_{DD1} = V_{DDP} = V_{ISO} = 5\text{ V}$, V_{SEL} resistor network: $R1 = 10\text{ k}\Omega \pm 1\%$, $R2 = 30.9\text{ k}\Omega \pm 1\%$ between V_{ISO} and GND_{ISO} (see Figure 31). Minimum/maximum specifications apply over the entire recommended operation range, which is $4.5\text{ V} \leq V_{DD1}$, V_{DDP} , $V_{ISO} \leq 5.5\text{ V}$, and $-40^\circ\text{C} \leq T_A \leq +105^\circ\text{C}$, unless otherwise noted. Switching specifications are tested with $C_L = 15\text{ pF}$ and CMOS signal levels, unless otherwise noted.

Table 3. DC-to-DC Converters Static Specifications

Parameter	Symbol	Min	Typ	Max	Unit	Test Conditions/Comments
DC-TO-DC CONVERTERS SUPPLY						
Setpoint	V_{ISO}	4.7	5.0	5.4	V	$I_{ISO} = 15\text{ mA}$, $R1 = 10\text{ k}\Omega$, $R2 = 30.9\text{ k}\Omega$
Line Regulation	$V_{ISO}(\text{LINE})$		20		mV/V	$I_{ISO} = 15\text{ mA}$, $V_{DDP} = 4.5\text{ V}$ to 5.5 V
Load Regulation	$V_{ISO}(\text{LOAD})$		1	5	%	$I_{ISO} = 3\text{ mA}$ to 27 mA
Output Ripple	$V_{ISO}(\text{RIP})$		75		mV p-p	20 MHz bandwidth, $C_{BO} = 0.1\text{ }\mu\text{F} 10\text{ }\mu\text{F}$, $I_{ISO} = 27\text{ mA}$
Output Noise	$V_{ISO}(\text{NOISE})$		200		mV p-p	$C_{BO} = 0.1\text{ }\mu\text{F} 10\text{ }\mu\text{F}$, $I_{ISO} = 27\text{ mA}$
Switching Frequency	f_{OSC}		125		MHz	
Pulse-Width Modulation Frequency	f_{PWM}		600		kHz	
Output Supply	$I_{ISO}(\text{MAX})$	30			mA	$V_{ISO} > 4.5\text{ V}$
Efficiency at $I_{ISO}(\text{MAX})$			29		%	$I_{ISO} = 27\text{ mA}$
V_{DDP} Supply Current						
No V_{ISO} Load	$I_{DDP}(\text{Q})$		14	20	mA	
Full V_{ISO} Load	$I_{DDP}(\text{MAX})$		104	140	mA	
Thermal Shutdown						
Shutdown Temperature			154		$^\circ\text{C}$	
Thermal Hysteresis			10		$^\circ\text{C}$	

Table 4. Data Channel Supply Current Specifications

Parameter	Symbol	1 Mbps			25 Mbps			100 Mbps			Unit	Test Conditions/Comments
		Min	Typ	Max	Min	Typ	Max	Min	Typ	Max		
SUPPLY CURRENT												$C_L = 0\text{ pF}$
ADuM5410	I_{DD1}	6.8	10		7.8	12		11.8	17.4		mA	
	I_{DD2}	2.1	3.7		3.9	5.7		9.2	13		mA	
ADuM5411	I_{DD1}	5.8	10.3		7.0	10.9		11.4	15.9		mA	
	I_{DD2}	4.0	6.85		5.5	8.5		10.3	14.0		mA	
ADuM5412	I_{DD1}	4.3	7.7		6.0	9.3		10.3	14.2		mA	
	I_{DD2}	5.3	8.7		6.7	10.1		11.0	14.9		mA	

Table 5. Switching Specifications

Parameter	Symbol	Min	Typ	Max	Unit	Test Conditions/Comments
SWITCHING SPECIFICATIONS						
Pulse Width	PW	6.6			ns	Within pulse width distortion (PWD) limit
Data Rate				150	Mbps	Within PWD limit
Propagation Delay	t_{PHL} , t_{PLH}	4.8	7.2	13	ns	50% input to 50% output
Pulse Width Distortion	PWD		0.5	3	ns	$ t_{PLH} - t_{PHL} $
Change vs. Temperature			1.5		ps/ $^\circ\text{C}$	
Propagation Delay Skew	t_{PSK}			6.1	ns	Between any two units at the same temperature, voltage, and load
Channel Matching						
Codirectional	t_{PSKCD}		0.5	3.0	ns	
Opposing Direction	t_{PSKOD}		0.5	3.0	ns	
Jitter			490		ps p-p	
			70		ps rms	

Table 6. Input and Output Characteristics

Parameter	Symbol	Min	Typ	Max	Unit	Test Conditions/ Comments
DC SPECIFICATIONS						
Input Threshold						
Logic High	V_{IH}	$0.7 \times V_{ISO}$ or $0.7 \times V_{DD1}$			V	
Logic Low	V_{IL}			$0.3 \times V_{ISO}$ or $0.3 \times V_{DD1}$	V	
Output Voltage						
Logic High	V_{OH}	$V_{DD1} - 0.2$ or $V_{DD2} - 0.2$	V_{DD1} or V_{DD2}		V	$I_{Ox}^1 = -20 \mu A, V_{Ix} = V_{IxB}^2$
Logic Low	V_{OL}	$V_{DD1} - 0.5$ or $V_{DD2} - 0.5$	$V_{DD1} - 0.2$ or $V_{DD2} - 0.2$	0.0 0.0 0.1 0.4	V V V V	$I_{Ox} = -4 \text{ mA}, V_{Ix} = V_{IxB}$ $I_{Ox} = 20 \mu A, V_{Ix} = V_{IxB}^3$ $I_{Ox} = 4 \text{ mA}, V_{Ix} = V_{IxB}$
Undervoltage Lockout	UVLO					$V_{DD1}, V_{DD2},$ and V_{DDP} supply
Positive Going Threshold	V_{UV+}		1.6		V	
Negative Going Threshold	V_{UV-}		1.5		V	
Hysteresis	V_{UVH}		0.1		V	
Input Currents per Channel	I_i	-10	+0.01	+10	μA	$0V \leq V_{Ix} \leq V_{DDx}$
Quiescent Supply Current						
ADuM5410						
$I_{DD1} (Q)$			1.2	2.2	mA	$V_{Ix} = \text{Logic } 0$
$I_{DD2} (Q)$			2.0	2.72	mA	$V_{Ix} = \text{Logic } 0$
$I_{DD1} (Q)$			12.0	20.0	mA	$V_{Ix} = \text{Logic } 1$
$I_{DD2} (Q)$			2.0	2.92	mA	$V_{Ix} = \text{Logic } 1$
ADuM5411						
$I_{DD1} (Q)$			1.6	2.46	mA	$V_{Ix} = \text{Logic } 0$
$I_{DD2} (Q)$			1.9	2.62	mA	$V_{Ix} = \text{Logic } 0$
$I_{DD1} (Q)$			10.0	17.0	mA	$V_{Ix} = \text{Logic } 1$
$I_{DD2} (Q)$			6.0	10.0	mA	$V_{Ix} = \text{Logic } 1$
ADuM5412						
$I_{DD1} (Q)$			1.6	2.46	mA	$V_{Ix} = \text{Logic } 0$
$I_{DD2} (Q)$			1.6	2.46	mA	$V_{Ix} = \text{Logic } 0$
$I_{DD1} (Q)$			7.2	11.5	mA	$V_{Ix} = \text{Logic } 1$
$I_{DD2} (Q)$			8.4	11.5	mA	$V_{Ix} = \text{Logic } 1$
Dynamic Supply Current						
Input	$I_{DD} (D)$		0.01		mA/Mbps	Inputs switching, 50% duty cycle
Output	$I_{DD} (D)$		0.01		mA/Mbps	Inputs switching, 50% duty cycle
AC SPECIFICATIONS						
Output Rise/Fall Time	t_R/t_F		2.5		ns	10% to 90%
Common-Mode Transient Immunity ⁴	$ CM_H $	75	100		kV/ μs	$V_{Ix} = V_{DD1}$ or V_{ISO} , common-mode voltage (V_{CM}) = 1000 V, transient magnitude = 800 V
	$ CM_L $	75	100		kV/ μs	$V_{Ix} = 0V, V_{CM} = 1000V$, transient magnitude = 800 V

¹ I_{Ox} is the Channel x output current, where x means A, B, C, or D.² V_{IxB} is the input side logic high.³ V_{IxB} is the input side logic low.⁴ $|CM_H|$ is the maximum common-mode voltage slew rate that can be sustained while maintaining the voltage output (V_O) > 0.8 V_{DDx} . $|CM_L|$ is the maximum common-mode voltage slew rate that can be sustained while maintaining $V_O > 0.8V$. The common-mode voltage slew rates apply to both the rising and falling common-mode voltage edges.

ELECTRICAL CHARACTERISTICS—3.3 V PRIMARY INPUT SUPPLY/3.3 V SECONDARY ISOLATED SUPPLY

All typical specifications are at $T_A = 25^\circ\text{C}$, $V_{DD1} = V_{DDP} = V_{ISO} = 3.3\text{ V}$, V_{SEL} resistor network: $R1 = 10\text{ k}\Omega$, $\pm 1\%$, $R2 = 16.9\text{ k}\Omega \pm 1\%$ between V_{ISO} and GND_{ISO} (see Figure 31). Minimum/maximum specifications apply over the entire recommended operation range, which is $3.0\text{ V} \leq V_{DD1}, V_{DDP}, V_{ISO} \leq 3.6\text{ V}$, and $-40^\circ\text{C} \leq T_A \leq +105^\circ\text{C}$, unless otherwise noted. Switching specifications are tested with $C_L = 15\text{ pF}$ and CMOS signal levels, unless otherwise noted.

Table 7. DC-to-DC Converter Static Specifications

Parameter	Symbol	Min	Typ	Max	Unit	Test Conditions/Comments
DC-TO-DC CONVERTER SUPPLY						
Setpoint	V_{ISO}	3.0	3.3	3.6	V	$I_{ISO} = 10\text{ mA}$, $R1 = 10\text{ k}\Omega$, $R2 = 16.9\text{ k}\Omega$
Line Regulation	$V_{ISO(LINE)}$		20		mV/V	$I_{ISO} = 10\text{ mA}$, $V_{DD1} = 3.0\text{ V to } 3.6\text{ V}$
Load Regulation	$V_{ISO(LOAD)}$		1	5	%	$I_{ISO} = 2\text{ mA to } 18\text{ mA}$
Output Ripple	$V_{ISO(RIP)}$		50		mV p-p	20 MHz bandwidth, $C_{BO} = 0.1\text{ }\mu\text{F} 10\text{ }\mu\text{F}$, $I_{ISO} = 18\text{ mA}$
Output Noise	$V_{ISO(NOISE)}$		130		mV p-p	$C_{BO} = 0.1\text{ }\mu\text{F} 10\text{ }\mu\text{F}$, $I_{ISO} = 18\text{ mA}$
Switching Frequency	f_{OSC}		125		MHz	
Pulse-Width Modulation Frequency	f_{PWM}		600		kHz	
Output Supply	$I_{ISO(MAX)}$	20			mA	$3.6\text{ V} > V_{ISO} > 3\text{ V}$
Efficiency at $I_{ISO(MAX)}$			27		%	$I_{ISO} = 18\text{ mA}$
V_{DDP} Supply Current						
No V_{ISO} Load	$I_{DDP(Q)}$		14	20	mA	
Full V_{ISO} Load	$I_{DDP(MAX)}$		77	115	mA	
Thermal Shutdown						
Shutdown Temperature			154		$^\circ\text{C}$	
Thermal Hysteresis			10		$^\circ\text{C}$	

Table 8. Data Channel Supply Current Specifications

Parameter	Symbol	1 Mbps			25 Mbps			100 Mbps			Unit	Test Conditions/Comments
		Min	Typ	Max	Min	Typ	Max	Min	Typ	Max		
SUPPLY CURRENT												$C_L = 0\text{ pF}$
ADuM5410	I_{DD1}	6.6	9.8		7.4	11.2		10.7	15.9		mA	
	I_{DD2}	2.0	3.7		3.5	5.5		8.2	11.6		mA	
ADuM5411	I_{DD1}	5.65	10.1		6.65	10.5		10.4	14.9		mA	
	I_{DD2}	3.9	6.65		5.2	8.0		9.4	12.8		mA	
ADuM5412	I_{DD1}	4.3	7.7		5.6	9.0		9.1	13		mA	
	I_{DD2}	5.0	8.4		6.2	9.6		9.8	13.7		mA	

Table 9. Switching Specifications

Parameter	Symbol	Min	Typ	Max	Unit	Test Conditions/Comments
SWITCHING SPECIFICATIONS						
Pulse Width	PW	6.7			ns	Within PWD limit
Data Rate				150	Mbps	Within PWD limit
Propagation Delay	t_{PHL}, t_{PLH}		6.8	14	ns	50% input to 50% output
Pulse Width Distortion	PWD		0.7	3.0	ns	$ t_{PLH} - t_{PHL} $
Change vs. Temperature			1.5		ps/ $^\circ\text{C}$	
Propagation Delay Skew	t_{PSK}			7.5	ns	Between any two units at the same temperature, voltage, and load
Channel Matching						
Codirectional	t_{PSKCD}		0.7	3.0	ns	
Opposing Direction	t_{PSKOD}		0.7	3.0	ns	
Jitter			640		ps p-p	
			75		ns rms	

Table 10. Input and Output Characteristics

Parameter	Symbol	Min	Typ	Max	Unit	Test Conditions/ Comments
DC SPECIFICATIONS						
Input Threshold						
Logic High	V_{IH}	$0.7 \times V_{ISO}$ or $0.7 \times V_{DD1}$			V	
Logic Low	V_{IL}			$0.3 \times V_{ISO}$ or $0.3 \times V_{DD1}$	V	
Output Voltage						
Logic High	V_{OH}	$V_{DD1} - 0.2$ or $V_{DD2} - 0.2$	V_{DD1} or V_{DD2}		V	$I_{OX} = -20 \mu A$, $V_{IX} = V_{IXH}$
Logic Low	V_{OL}	$V_{DD1} - 0.5$ or $V_{DD2} - 0.5$	$V_{DD1} - 0.2$ or $V_{DD2} - 0.2$	0.0	V	$I_{OX} = -4 \text{ mA}$, $V_{IX} = V_{IXH}$
Logic Low			0.0	0.1	V	$I_{OX} = 20 \mu A$, $V_{IX} = V_{IXL}$
Logic Low			0.0	0.4	V	$I_{OX} = 4 \text{ mA}$, $V_{IX} = V_{IXL}$
Undervoltage Lockout	UVLO					V_{DD1} , V_{DD2} , and V_{DDP} supply
Positive Going Threshold	V_{UV+}		1.6		V	
Negative Going Threshold	V_{UV-}		1.5		V	
Hysteresis	V_{UVH}		0.1		V	
Input Currents per Channel	I_I	-10	+0.01	+10	μA	$0V \leq V_{IX} \leq V_{DDX}$
Quiescent Supply Current						
ADuM5410						
$I_{DD1(Q)}$			1.2	2.12	mA	$V_{IX} = \text{Logic 0}$
$I_{DD2(Q)}$			2.0	2.68	mA	$V_{IX} = \text{Logic 0}$
$I_{DD1(Q)}$			12.0	19.6	mA	$V_{IX} = \text{Logic 1}$
$I_{DD2(Q)}$			2.0	2.8	mA	$V_{IX} = \text{Logic 1}$
ADuM5411						
$I_{DD1(Q)}$			1.5	2.36	mA	$V_{IX} = \text{Logic 0}$
$I_{DD2(Q)}$			1.8	2.52	mA	$V_{IX} = \text{Logic 0}$
$I_{DD1(Q)}$			9.8	16.7	mA	$V_{IX} = \text{Logic 1}$
$I_{DD2(Q)}$			5.7	9.7	mA	$V_{IX} = \text{Logic 1}$
ADuM5412						
$I_{DD1(Q)}$			1.6	2.4	mA	$V_{IX} = \text{Logic 0}$
$I_{DD2(Q)}$			1.6	2.4	mA	$V_{IX} = \text{Logic 0}$
$I_{DD1(Q)}$			7.2	11.2	mA	$V_{IX} = \text{Logic 1}$
$I_{DD2(Q)}$			8.4	11.2	mA	$V_{IX} = \text{Logic 1}$
Dynamic Supply Current						
Input	$I_{DDI(D)}$		0.01		mA/Mbps	Inputs switching, 50% duty cycle
Output	$I_{DDO(D)}$		0.01		mA/Mbps	Inputs switching, 50% duty cycle
AC SPECIFICATIONS						
Output Rise/Fall Time	t_R/t_F		2.5		ns	10% to 90%
Common-Mode Transient Immunity ¹	$ CM_H $	75	100		kV/ μs	$V_{IX} = V_{DD1}$ or V_{ISO} , $V_{CM} = 1000 \text{ V}$, transient magnitude = 800 V
	$ CM_L $	75	100		kV/ μs	$V_{IX} = 0 \text{ V}$, $V_{CM} = 1000 \text{ V}$, transient magnitude = 800 V

¹ $|CM_H|$ is the maximum common-mode voltage slew rate that can be sustained while maintaining the voltage output (V_O) > 0.8 V_{DDX} . $|CM_L|$ is the maximum common-mode voltage slew rate that can be sustained while maintaining $V_O > 0.8 \text{ V}$. The common-mode voltage slew rates apply to both the rising and falling common-mode voltage edges.

ELECTRICAL CHARACTERISTICS—5 V PRIMARY INPUT SUPPLY/3.3 V SECONDARY ISOLATED SUPPLY

All typical specifications are at $T_A = 25^\circ\text{C}$, $V_{DD1} = V_{DDP} = 5.0\text{ V}$, $V_{ISO} = 3.3\text{ V}$, V_{SEL} resistor network: $R1 = 10\text{ k}\Omega \pm 1\%$, $R2 = 16.9\text{ k}\Omega \pm 1\%$ between V_{ISO} and GND_{ISO} (see Figure 31). Minimum/maximum specifications apply over the entire recommended operation range, which is $4.5\text{ V} \leq V_{DD1} = V_{DDP} \leq 5.5\text{ V}$, $3.0\text{ V} \leq V_{ISO} \leq 3.6\text{ V}$, and $-40^\circ\text{C} \leq T_A \leq +105^\circ\text{C}$, unless otherwise noted. Switching specifications are tested with $C_L = 15\text{ pF}$ and CMOS signal levels, unless otherwise noted.

Table 11. DC-to-DC Converter Static Specifications

Parameter	Symbol	Min	Typ	Max	Unit	Test Conditions/Comments
DC-TO-DC CONVERTER SUPPLY						
Setpoint	V_{ISO}	3.0	3.3	3.6	V	$I_{ISO} = 15\text{ mA}$, $R1 = 10\text{ k}\Omega$, $R2 = 16.9\text{ k}\Omega$
Line Regulation	$V_{ISO(LINE)}$		20		mV/V	$I_{ISO} = 15\text{ mA}$, $V_{DD1} = 3.0\text{ V to } 3.6\text{ V}$
Load Regulation	$V_{ISO(LOAD)}$		1	5	%	$I_{ISO} = 3\text{ mA to } 27\text{ mA}$
Output Ripple	$V_{ISO(RIP)}$		50		mV p-p	20 MHz bandwidth, $C_{BO} = 0.1\text{ }\mu\text{F} 10\text{ }\mu\text{F}$, $I_{ISO} = 27\text{ mA}$
Output Noise	$V_{ISO(NOISE)}$		130		mV p-p	$C_{BO} = 0.1\text{ }\mu\text{F} 10\text{ }\mu\text{F}$, $I_{ISO} = 27\text{ mA}$
Switching Frequency	f_{OSC}		125		MHz	
Pulse-Width Modulation Frequency	f_{PWM}		600		kHz	
Output Supply	$I_{ISO(MAX)}$	30			mA	$3.6\text{ V} > V_{ISO} > 3\text{ V}$
Efficiency at $I_{ISO(MAX)}$			24		%	$I_{ISO} = 27\text{ mA}$
V_{DDP} Supply Current						
No V_{ISO} Load	$I_{DDP(Q)}$		14	20	mA	
Full V_{ISO} Load	$I_{DDP(MAX)}$		85	115	mA	
Thermal Shutdown						
Shutdown Temperature			154		$^\circ\text{C}$	
Thermal Hysteresis			10		$^\circ\text{C}$	

Table 12. Data Channel Supply Current Specifications

Parameter	Symbol	1 Mbps			25 Mbps			100 Mbps			Unit	Test Conditions/Comments
		Min	Typ	Max	Min	Typ	Max	Min	Typ	Max		
SUPPLY CURRENT												$C_L = 0\text{ pF}$
ADuM5410	I_{DD1}	6.8	10		7.8	12		11.8	17.4		mA	
	I_{DD2}	2.0	3.7		3.5	5.5		8.2	11.6		mA	
ADuM5411	I_{DD1}	5.8	10.3		7.0	10.9		11.4	15.9		mA	
	I_{DD2}	3.9	6.65		5.2	8.0		9.4	12.8		mA	
ADuM5412	I_{DD1}	4.3	7.7		6.0	9.3		10.3	14.2		mA	
	I_{DD2}	5.0	8.4		6.2	9.6		9.8	13.7		mA	

Table 13. Switching Specifications

Parameter	Symbol	Min	Typ	Max	Unit	Test Conditions/Comments
SWITCHING SPECIFICATIONS						
Pulse Width	PW	6.7			ns	Within PWD limit
Data Rate				150	Mbps	Within PWD limit
Propagation Delay	t_{PHL}, t_{PLH}		6.8	14	ns	50% input to 50% output
Pulse Width Distortion	PWD		0.7	3.0	ns	$ t_{PLH} - t_{PHL} $
Change vs. Temperature			1.5		ps/ $^\circ\text{C}$	
Propagation Delay Skew	t_{PSK}			7.5	ns	Between any two units at the same temperature, voltage, and load
Channel Matching						
Codirectional	t_{PSKCD}		0.7	3.0	ns	
Opposing Direction	t_{PSKOD}		0.7	3.0	ns	
Jitter			640		ps p-p	
			75		ns rms	

Table 14. Input and Output Characteristics

Parameter	Symbol	Min	Typ	Max	Unit	Test Conditions/ Comments
DC SPECIFICATIONS						
Input Threshold						
Logic High	V_{IH}	$0.7 \times V_{ISO}$ or $0.7 \times V_{DD1}$			V	
Logic Low	V_{IL}			$0.3 \times V_{ISO}$ or $0.3 \times V_{DD1}$	V	
Output Voltage						
Logic High	V_{OH}	$V_{DD1} - 0.2$ or $V_{DD2} - 0.2$	V_{DD1} or V_{DD2}		V	$I_{Ox} = -20 \mu A, V_{Ix} = V_{IxH}$
		$V_{DD1} - 0.5$ or $V_{DD2} - 0.5$	$V_{DD1} - 0.2$ or $V_{DD2} - 0.2$		V	$I_{Ox} = -4 \text{ mA}, V_{Ix} = V_{IxH}$
Logic Low	V_{OL}		0.0	0.1	V	$I_{Ox} = 20 \mu A, V_{Ix} = V_{IxL}$
			0.0	0.4	V	$I_{Ox} = 4 \text{ mA}, V_{Ix} = V_{IxL}$
Undervoltage Lockout	UVLO					$V_{DD1}, V_{DD2},$ and V_{DDP} supply
Positive Going Threshold	V_{UV+}		1.6		V	
Negative Going Threshold	V_{UV-}		1.5		V	
Hysteresis	V_{UVH}		0.1		V	
Input Currents per Channel	I_i	-10	+0.01	+10	μA	$0V \leq V_{Ix} \leq V_{DDx}$
Quiescent Supply Current						
ADuM5410						
	$I_{DD1(Q)}$		1.2	2.2	mA	$V_{Ix} = \text{Logic 0}$
	$I_{DD2(Q)}$		2.0	2.68	mA	$V_{Ix} = \text{Logic 0}$
	$I_{DD1(Q)}$		12.0	20.0	mA	$V_{Ix} = \text{Logic 1}$
	$I_{DD2(Q)}$		2.0	2.8	mA	$V_{Ix} = \text{Logic 1}$
ADuM5411						
	$I_{DD1(Q)}$		1.6	2.46	mA	$V_{Ix} = \text{Logic 0}$
	$I_{DD2(Q)}$		1.8	2.52	mA	$V_{Ix} = \text{Logic 0}$
	$I_{DD1(Q)}$		10.0	17.0	mA	$V_{Ix} = \text{Logic 1}$
	$I_{DD2(Q)}$		5.7	9.7	mA	$V_{Ix} = \text{Logic 1}$
ADuM5412						
	$I_{DD1(Q)}$		1.6	2.46	mA	$V_{Ix} = \text{Logic 0}$
	$I_{DD2(Q)}$		1.6	2.4	mA	$V_{Ix} = \text{Logic 0}$
	$I_{DD1(Q)}$		7.2	11.5	mA	$V_{Ix} = \text{Logic 1}$
	$I_{DD2(Q)}$		8.4	11.2	mA	$V_{Ix} = \text{Logic 1}$
Dynamic Supply Current						
Input	$I_{DDI(D)}$		0.01		mA/Mbps	Inputs switching, 50% duty cycle
Output	$I_{DDO(D)}$		0.01		mA/Mbps	Inputs switching, 50% duty cycle
AC SPECIFICATIONS						
Output Rise/Fall Time	t_R/t_F		2.5		ns	10% to 90%
Common-Mode Transient Immunity ¹	$ CM_H $	75	100		kV/ μs	$V_{Ix} = V_{DD1}$ or $V_{ISO}, V_{CM} = 1000 \text{ V},$ transient magnitude = 800 V
	$ CM_L $	75	100		kV/ μs	$V_{Ix} = 0 \text{ V}, V_{CM} = 1000 \text{ V},$ transient magnitude = 800 V

¹ $|CM_H|$ is the maximum common-mode voltage slew rate that can be sustained while maintaining the voltage output (V_O) > 0.8 V_{DDx} . $|CM_L|$ is the maximum common-mode voltage slew rate that can be sustained while maintaining $V_O > 0.8 \text{ V}$. The common-mode voltage slew rates apply to both the rising and falling common-mode voltage edges.

ELECTRICAL CHARACTERISTICS—2.5 V OPERATION DIGITAL ISOLATOR CHANNELS ONLY

All typical specifications are at $T_A = 25^\circ\text{C}$, $V_{DD1} = V_{DD2} = 2.5\text{ V}$. Minimum/maximum specifications apply over the entire recommended operation range: $2.25\text{ V} \leq V_{DD1} \leq 2.75\text{ V}$, $2.25\text{ V} \leq V_{DD2} \leq 2.75\text{ V}$, $-40^\circ\text{C} \leq T_A \leq +105^\circ\text{C}$, unless otherwise noted. Switching specifications are tested with $C_L = 15\text{ pF}$ and CMOS signal levels, unless otherwise noted. Supply currents are specified with 50% duty cycle signals.

Table 15. Data Channel Supply Current Specifications

Parameter	Symbol	1 Mbps			25 Mbps			100 Mbps			Unit	Test Conditions/Comments
		Min	Typ	Max	Min	Typ	Max	Min	Typ	Max		
SUPPLY CURRENT												$C_L = 0\text{ pF}$
ADuM5410	I_{DD1}	6.5	9.8		7.3	11.1		10.4	15.5		mA	
	I_{DD2}	2.0	3.6		3.3	5.2		7.3	10.2		mA	
ADuM5411	I_{DD1}	5.6	10.0		6.4	10.4		9.7	14.5		mA	
	I_{DD2}	3.8	6.55		4.8	7.7		8.3	11.5		mA	
ADuM5412	I_{DD1}	4.3	7.7		5.4	8.8		8.8	12.7		mA	
	I_{DD2}	5.0	8.4		6.1	9.5		9.5	13.4		mA	

Table 16. Switching Specifications

Parameter	Symbol	Min	Typ	Max	Unit	Test Conditions/Comments
SWITCHING SPECIFICATIONS						
Pulse Width	PW	6.6			ns	Within PWD limit
Data Rate				150	Mbps	Within PWD limit
Propagation Delay	t_{PHL} , t_{PLH}	5.0	7.0	14	ns	50% input to 50% output
Pulse Width Distortion	PWD		0.7	3	ns	$ t_{PLH} - t_{PHL} $
Change vs. Temperature			1.5		ps/ $^\circ\text{C}$	
Propagation Delay Skew	t_{PSK}			6.8	ns	Between any two units at the same temperature, voltage, and load
Channel Matching						
Codirectional	t_{PSKCD}		0.7	3.0	ns	
Opposing Direction	t_{PSKOD}		0.7	3.0	ns	
Jitter			800		ps p-p	
			190		ps rms	

Table 17. Input and Output Characteristics

Parameter	Symbol	Min	Typ	Max	Unit	Test Conditions/ Comments
DC SPECIFICATIONS						
Input Threshold						
Logic High	V_{IH}	$0.7 \times V_{ISO}$ or $0.7 \times V_{DD1}$			V	
Logic Low	V_{IL}			$0.3 \times V_{ISO}$ or $0.3 \times V_{DD1}$	V	
Output Voltage						
Logic High	V_{OH}	$V_{DD1} - 0.2$ or $V_{DD2} - 0.2$	V_{DD1} or V_{DD2}		V	$I_{Ox} = -20 \mu A, V_{Ix} = V_{IxH}$
Logic Low	V_{OL}	$V_{DD1} - 0.5$ or $V_{DD2} - 0.5$	$V_{DD1} - 0.2$ or $V_{DD2} - 0.2$	0.0 0.0	V V	$I_{Ox} = -4 \text{ mA}, V_{Ix} = V_{IxH}$ $I_{Ox} = 20 \mu A, V_{Ix} = V_{IxL}$ $I_{Ox} = 4 \text{ mA}, V_{Ix} = V_{IxL}$
Undervoltage Lockout	UVLO					$V_{DD1}, V_{DD2},$ and V_{DDP} supply
Positive Going Threshold	V_{UV+}		1.6		V	
Negative Going Threshold	V_{UV-}		1.5		V	
Hysteresis	V_{UVH}		0.1		V	
Input Currents per Channel	I_i	-10	+0.01	+10	μA	$0V \leq V_{Ix} \leq V_{DDx}$
Quiescent Supply Current						
ADuM5410						
$I_{DD1(Q)}$			1.2	2.0	mA	$V_{Ix} = \text{Logic 0}$
$I_{DD2(Q)}$			2.0	2.64	mA	$V_{Ix} = \text{Logic 0}$
$I_{DD1(Q)}$			1.2	19.6	mA	$V_{Ix} = \text{Logic 1}$
$I_{DD2(Q)}$			2.0	2.76	mA	$V_{Ix} = \text{Logic 1}$
ADuM5411						
$I_{DD1(Q)}$			1.46	2.32	mA	$V_{Ix} = \text{Logic 0}$
$I_{DD2(Q)}$			1.75	2.47	mA	$V_{Ix} = \text{Logic 0}$
$I_{DD1(Q)}$			9.7	16.6	mA	$V_{Ix} = \text{Logic 1}$
$I_{DD2(Q)}$			5.67	9.67	mA	$V_{Ix} = \text{Logic 1}$
ADuM5412						
$I_{DD1(Q)}$			1.6	2.32	mA	$V_{Ix} = \text{Logic 0}$
$I_{DD2(Q)}$			1.6	2.32	mA	$V_{Ix} = \text{Logic 0}$
$I_{DD1(Q)}$			7.2	11.2	mA	$V_{Ix} = \text{Logic 1}$
$I_{DD2(Q)}$			8.4	11.2	mA	$V_{Ix} = \text{Logic 1}$
Dynamic Supply Current						
Dynamic Input	$I_{DDI(D)}$		0.01		mA/Mbps	Inputs switching, 50% duty cycle
Dynamic Output	$I_{DDO(D)}$		0.01		mA/Mbps	Inputs switching, 50% duty cycle
AC SPECIFICATIONS						
Output Rise/Fall Time	t_R/t_F		2.5		ns	10% to 90%
Common-Mode Transient Immunity ¹	$ CM_H $	75	100		kV/ μs	$V_{Ix} = V_{DD1}$ or $V_{ISO}, V_{CM} = 1000 \text{ V},$ transient magnitude = 800 V
	$ CM_L $	75	100		kV/ μs	$V_{Ix} = 0 \text{ V}, V_{CM} = 1000 \text{ V},$ transient magnitude = 800 V

¹ $|CM_H|$ is the maximum common-mode voltage slew rate that can be sustained while maintaining the voltage output (V_O) > 0.8 V_{DDx} . $|CM_L|$ is the maximum common-mode voltage slew rate that can be sustained while maintaining $V_O > 0.8 \text{ V}$. The common-mode voltage slew rates apply to both the rising and falling common-mode voltage edges.

ELECTRICAL CHARACTERISTICS—1.8 V OPERATION DIGITAL ISOLATOR CHANNELS ONLY

All typical specifications are at $T_A = 25^\circ\text{C}$, $V_{DD1} = V_{DD2} = 1.8\text{ V}$. Minimum/maximum specifications apply over the entire recommended operation range: $1.7\text{ V} \leq V_{DD1} \leq 1.9\text{ V}$, $1.7\text{ V} \leq V_{DD2} \leq 1.9\text{ V}$, and $-40^\circ\text{C} \leq T_A \leq +105^\circ\text{C}$, unless otherwise noted. Switching specifications are tested with $C_L = 15\text{ pF}$ and CMOS signal levels, unless otherwise noted. Supply currents are specified with 50% duty cycle signals.

Table 18. Data Channel Supply Current Specifications

Parameter	Symbol	1 Mbps			25 Mbps			100 Mbps			Unit	Test Conditions/Comments
		Min	Typ	Max	Min	Typ	Max	Min	Typ	Max		
SUPPLY CURRENT												$C_L = 0\text{ pF}$
ADuM5410	I_{DD1}	6.4	9.8		7.2	11		10.2	15.2	mA		
	I_{DD2}	1.9	3.5		3.1	5.0		6.8	10	mA		
ADuM5411	I_{DD1}	5.5	9.1		6.3	10.0		9.6	14.0	mA		
	I_{DD2}	3.72	6.45		4.8	7.5		8.4	11.2	mA		
ADuM5412	I_{DD1}	4.3	7.7		5.3	8.7		8.6	12.6	mA		
	I_{DD2}	4.9	8.3		6.0	9.4		9.3	13.3	mA		

Table 19. Switching Specifications

Parameter	Symbol	Min	Typ	Max	Unit	Test Conditions/Comments
SWITCHING SPECIFICATIONS						
Pulse Width	PW	6.6			ns	Within PWD limit
Data Rate				150	Mbps	Within PWD limit
Propagation Delay	t_{PHL}, t_{PLH}	5.8	8.7	15	ns	50% input to 50% output
Pulse Width Distortion	PWD		0.7	3	ns	$ t_{PLH} - t_{PHL} $
Change vs. Temperature			1.5		ps/ $^\circ\text{C}$	
Propagation Delay Skew	t_{PSK}			7.0	ns	Between any two units at the same temperature, voltage, and load
Channel Matching						
Codirectional	t_{PSKCD}		0.7	3.0	ns	
Opposing Direction	t_{PSKOD}		0.7	3.0	ns	
Jitter			470		ps p-p	
			70		ps rms	

Table 20. Input and Output Characteristics

Parameter	Symbol	Min	Typ	Max	Unit	Test Conditions/ Comments
DC SPECIFICATIONS						
Input Threshold						
Logic High	V_{IH}	$0.7 \times V_{DDx}$			V	
Logic Low	V_{IL}			$0.3 \times V_{DDx}$	V	
Output Voltages						
Logic High	V_{OH}	$V_{DDx} - 0.1$	V_{DDx}		V	$I_{Ox} = -20 \mu A, V_{Ix} = V_{IxH}$
		$V_{DDx} - 0.4$	$V_{DDx} - 0.2$		V	$I_{Ox} = -4 \text{ mA}, V_{Ix} = V_{IxH}$
Logic Low	V_{OL}		0.0	0.1	V	$I_{Ox} = 20 \mu A, V_{Ix} = V_{IxL}$
			0.2	0.4	V	$I_{Ox} = 4 \text{ mA}, V_{Ix} = V_{IxL}$
Undervoltage Lockout	UVLO					$V_{DD1}, V_{DD2},$ and V_{DDP} supply
Positive Going Threshold	V_{UV+}		1.6		V	
Negative Going Threshold	V_{UV-}		1.5		V	
Hysteresis	V_{UVH}		0.1		V	
Input Currents per Channel	I_i	-10	+0.01	+10	μA	$0 V \leq V_{Ix} \leq V_{DDx}$
Quiescent Supply Current						
ADuM5410						
	$I_{DD1(Q)}$		1.2	1.92	mA	$V_{Ix} = \text{Logic 0}$
	$I_{DD2(Q)}$		2.0	2.64	mA	$V_{Ix} = \text{Logic 0}$
	$I_{DD1(Q)}$		12.0	19.6	mA	$V_{Ix} = \text{Logic 1}$
	$I_{DD2(Q)}$		2.0	2.76	mA	$V_{Ix} = \text{Logic 1}$
ADuM5411						
	$I_{DD1(Q)}$		1.4	2.28	mA	$V_{Ix} = \text{Logic 0}$
	$I_{DD2(Q)}$		1.73	2.45	mA	$V_{Ix} = \text{Logic 0}$
	$I_{DD1(Q)}$		9.6	16.5	mA	$V_{Ix} = \text{Logic 1}$
	$I_{DD2(Q)}$		5.6	9.6	mA	$V_{Ix} = \text{Logic 1}$
ADuM5412						
	$I_{DD1(Q)}$		1.6	2.28	mA	$V_{Ix} = \text{Logic 0}$
	$I_{DD2(Q)}$		1.6	2.28	mA	$V_{Ix} = \text{Logic 0}$
	$I_{DD1(Q)}$		7.2	11.2	mA	$V_{Ix} = \text{Logic 1}$
	$I_{DD2(Q)}$		8.4	11.2	mA	$V_{Ix} = \text{Logic 1}$
Dynamic Supply Current						
Input	$I_{DDI(D)}$		0.01		mA/Mbps	Inputs switching, 50% duty cycle
Output	$I_{DDO(D)}$		0.01		mA/Mbps	Inputs switching, 50% duty cycle
AC SPECIFICATIONS						
Output Rise/Fall Time	t_r/t_f		2.5		ns	10% to 90%
Common-Mode Transient Immunity ¹	$ CM_H $	75	100		kV/ μs	$V_{Ix} = V_{DD1}$ or $V_{ISO}, V_{CM} = 1000 V,$ transient magnitude = 800 V
	$ CM_L $	75	100		kV/ μs	$V_{Ix} = 0 V, V_{CM} = 1000 V,$ transient magnitude = 800 V

¹ $|CM_H|$ is the maximum common-mode voltage slew rate that can be sustained while maintaining the voltage output (V_O) > 0.8 V_{DDx} . $|CM_L|$ is the maximum common-mode voltage slew rate that can be sustained while maintaining $V_O > 0.8 V$. The common-mode voltage slew rates apply to both the rising and falling common-mode voltage edges.

PACKAGE CHARACTERISTICS

Table 21. Thermal and Isolation Characteristics

Parameter	Symbol	Min	Typ	Max	Unit	Test Conditions/Comments
Resistance (Input to Output) ¹	R _{I-O}		10 ¹²		Ω	
Capacitance (Input to Output) ¹	C _{I-O}		2.2		pF	f = 1 MHz
Input Capacitance ²	C _I		4.0		pF	
IC Junction to Ambient Thermal Resistance	θ _{JA}		50		°C/W	Thermocouple located at center of package underside, test conducted on 4-layer board with thin traces ³

¹ The device is considered a 2-terminal device: Pin 1 to Pin 8 are shorted together, and Pin 9 to Pin 16 are shorted together.

² Input capacitance is from any input data pin to ground.

³ See the Thermal Analysis section for thermal model definitions.

REGULATORY APPROVALS

Table 22.

UL (Pending) ¹	CSA (Pending)	VDE (Pending) ²	CQC (Pending)
Recognized Under 1577 Component Recognition Program ¹	Approved under CSA Component Acceptance Notice 5A	DIN V VDE V 0884-10 (VDE V 0884-10):2006-12	Certified under CQC11-471543-2012
Single Protection, 2500 V rms Isolation Voltage	CSA 60950-1-07+A1+A2 and IEC 60950-1, second edition, +A1+A2: Basic insulation at 400 V rms (565 V peak) Basic insulation (1MOPP), 250 V rms (354 V peak) CSA 61010-1-12 and IEC 61010-1 third edition Basic insulation at 300 V rms mains, 530 V rms (750 V peak)	Reinforced Insulation 565 V peak, V _{IOSM} = 4 kV peak	GB4943.1-2011: Basic insulation at 400 V rms (565 V peak)
File E214100	File 205078	File 2471900-4880-0001	File (pending)

¹ In accordance with UL 1577, each ADuM5410/ADuM5411/ADuM5412 is proof tested by applying an insulation test voltage ≥ 3000 V rms for 1 second (current leakage detection limit = 10 μA).

² In accordance with DIN V VDE V 0884-10, each ADuM5410/ADuM5411/ADuM5412 is proof tested by applying an insulation test voltage ≥ 1050 V peak for 1 second (partial discharge detection limit = 5 pC). The * marking branded on the component designates DIN V VDE V 0884-10 approval.

INSULATION AND SAFETY RELATED SPECIFICATIONS

Table 23. Critical Safety Related Dimensions and Material Properties

Parameter	Symbol	Value	Unit	Test Conditions/Comments
Rated Dielectric Insulation Voltage		2500	V rms	1-minute duration
Minimum External Air Gap (Clearance)	L(I01)	5.3	mm min	Measured from input terminals to output terminals, shortest distance through air
Minimum External Tracking (Creepage)	L(I02)	5.3	mm min	Measured from input terminals to output terminals, shortest distance path along body
Minimum Clearance in the Plane of the Printed Circuit Board (PCB Clearance)	L (PCB)	5.6	mm min	Measured from input terminals to output terminals, shortest distance through air, line of sight, in the PCB mounting plane
Minimum Internal Gap (Internal Clearance)		17	μm min	Minimum distance through insulation
Tracking Resistance (Comparative Tracking Index)	CTI	>400	V	DIN IEC 112/VDE 0303, Part 1
Isolation Group		II		Material group (DIN VDE 0110, 1/89, Table 1)

DIN V VDE V 0884-10 (VDE V 0884-10) INSULATION CHARACTERISTICS

These isolators are suitable for reinforced electrical isolation only within the safety limit data. Maintenance of the safety data is ensured by the protective circuits. The asterisk (*) marking on packages denotes DIN V VDE V 0884-10 approval.

Table 24. VDE Characteristics

Description	Test Conditions/Comments	Symbol	Characteristic	Unit
Installation Classification per DIN VDE 0110 For Rated Mains Voltage ≤ 150 V rms For Rated Mains Voltage ≤ 300 V rms For Rated Mains Voltage ≤ 400 V rms			I to IV I to IV I to III	
Climatic Classification			40/105/21	
Pollution Degree per DIN VDE 0110, Table 1			2	
Maximum Working Insulation Voltage		V _{IORM}	565	V peak
Input to Output Test Voltage, Method b1	V _{IORM} × 1.875 = V _{PR} , 100% production test, t _m = 1 sec, partial discharge < 5 pC	V _{PR}	1059	V peak
Input to Output Test Voltage, Method a After Environmental Tests Subgroup 1	V _{IORM} × 1.5 = V _{pd(m)} , t _{ini} = 60 sec, t _m = 10 sec, partial discharge < 5 pC	V _{PR} V _{pd(m)}	848	V peak
After Input and/or Safety Test Subgroup 2 and Subgroup 3	V _{IORM} × 1.2 = V _{pd(m)} , t _{ini} = 60 sec, t _m = 10 sec, partial discharge < 5 pC	V _{pd(m)}	678	V peak
Highest Allowable Overvoltage	Transient overvoltage, t _{TR} = 10 sec	V _{IOTM}	3535	V peak
Withstand Isolation Voltage	1 minute withstand rating	V _{ISO}	2500	V rms
Surge Isolation Voltage Basic	V _{IOSM(TEST)} = 10 kV; 1.2 μs rise time; 50 μs, 50% fall time	V _{ISOM}	4000	V peak
Safety Limiting Values	Maximum value allowed in the event of a failure (see Figure 2)			
Case Temperature		T _S	150	°C
Total Power Dissipation at 25°C		I _{S1}	2.5	W
Insulation Resistance at T _S	V _{IO} = 500 V	R _S	>10 ⁹	Ω

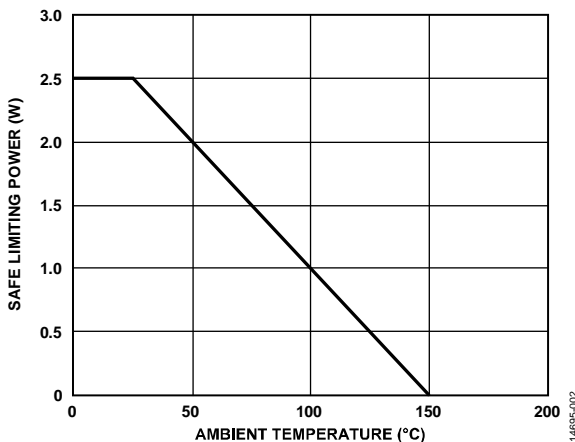

Figure 2. Thermal Derating Curve, Dependence of Safety Limiting Values on Case Temperature, per DIN EN 60747-5-2

RECOMMENDED OPERATING CONDITIONS

Table 25.

Parameter	Symbol	Min	Max	Unit
Operating Temperature ¹	T _A	-40	+105	°C
Supply Voltages ²				
V _{DDP} at V _{ISO} = 3.0V to 3.6V	V _{DDP}	3.0	5.5	V
V _{DDP} at V _{ISO} = 4.5V to 5.5V		4.5	5.5	V
V _{DD1} , V _{DD2}	V _{DD1} , V _{DD2}	1.7	5.5	V

¹ Operation at 105°C requires reduction of the maximum load current as specified in Table 26.

² Each voltage is relative to its respective ground.

ABSOLUTE MAXIMUM RATINGS

Ambient temperature (T_A) = 25°C, unless otherwise noted.

Table 26.

Parameter	Rating
Storage Temperature (T_{ST})	-55°C to +150°C
Ambient Operating Temperature (T_A)	-40°C to +105°C
Supply Voltages (V_{DD1} , V_{DDP} , V_{DD2} , V_{ISO}) ¹	-0.5 V to +7.0 V
V_{ISO} Supply Current ²	
$T_A = -40^\circ\text{C to } +105^\circ\text{C}$	30 mA
Input Voltage (V_{IA} , V_{IB} , V_{IC} , V_{ID} , V_{E1} , V_{E2} , V_{SEL} , $PDIS$) ^{1,3}	-0.5 V to $V_{DD1} + 0.5$ V
Output Voltage (V_{OA} , V_{OB} , V_{OC} , V_{OD}) ^{1,3}	-0.5 V to $V_{DD0} + 0.5$ V
Average Output Current Per Data Output Pin ⁴	-10 mA to +10 mA
Common-Mode Transients ⁵	-150 kV/ μ s to +150 kV/ μ s

¹ All voltages are relative to their respective ground.

² The V_{ISO} pin provides current for dc and dynamic loads on the V_{ISO} input/output channels. This current must be included when determining the total V_{ISO} supply current. For ambient temperatures between 85°C and 105°C, the maximum allowed current is reduced.

³ V_{DD1} and V_{DD0} refer to the supply voltages on the input and output sides of a given channel, respectively. See the PCB Layout section.

⁴ See Figure 2 for the maximum rated current values for various temperatures.

⁵ Common-mode transients refers to common-mode transients across the insulation barrier. Common-mode transients exceeding the absolute maximum ratings may cause latch-up or permanent damage.

Stresses at or above those listed under Absolute Maximum Ratings may cause permanent damage to the product. This is a stress rating only; functional operation of the product at these or any other conditions above those indicated in the operational section of this specification is not implied. Operation beyond the maximum operating conditions for extended periods may affect product reliability.

Table 27. Maximum Continuous Working Voltage Supporting 50-Year Minimum Lifetime¹

Parameter	Max	Unit	Applicable Certification
AC Voltage			
Bipolar Waveform	560	V peak	All certifications, 50-year operation
Unipolar Waveform			
Basic Insulation	560	V peak	
DC Voltage			
Basic Insulation	560	V peak	

¹ Maximum continuous working voltage refers to the continuous voltage magnitude imposed across the isolation barrier. See the Insulation Lifetime section for more information.

ESD CAUTION



ESD (electrostatic discharge) sensitive device. Charged devices and circuit boards can discharge without detection. Although this product features patented or proprietary protection circuitry, damage may occur on devices subjected to high energy ESD. Therefore, proper ESD precautions should be taken to avoid performance degradation or loss of functionality.

PIN CONFIGURATIONS AND FUNCTION DESCRIPTIONS

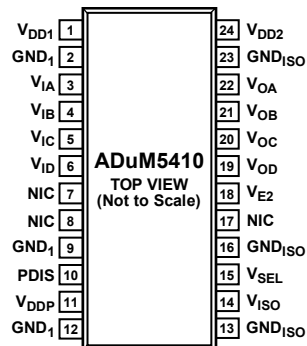

NIC = NO INTERNAL CONNECTION.
LEAVE THESE PINS FLOATING.

Figure 3. ADuM5410 Pin Configuration

14685-003

Table 28. ADuM5410 Pin Function Descriptions

Pin No.	Mnemonic	Description
1	V _{DD1}	Power Supply for the Side 1 Logic Circuits of the Device. This pin is independent of V _{DDP} and operates between 3.0 V and 5.5 V.
2, 9, 12	GND ₁	Ground 1. Ground reference for the primary isolator. Pin 2, Pin 9, and Pin 12 are internally connected, and it is recommended that these pins be connected to a common ground.
3	V _{IA}	Logic Input A.
4	V _{IB}	Logic Input B.
5	V _{IC}	Logic Input C.
6	V _{ID}	Logic Input D.
7, 8, 17	NIC	No Internal Connection. Leave these pins floating.
10	PDIS	Power Disable. When tied to any GND ₁ pin, the power converter is active; when a logic high voltage is applied, the power supply enters a low power standby mode.
11	V _{DDP}	Primary Supply Voltage, 3.0 V to 5.5 V.
13, 16, 23	GND _{ISO}	Ground Reference for V _{DD2} and V _{ISO} on Side 2. Pin 13, Pin 16, and Pin 23 are internally connected, and it is recommended that these pins be connected to a common ground.
14	V _{ISO}	Secondary Supply Voltage Output for External Loads. Connect to V _{DD2} to power the isolator channels.
15	V _{SEL}	Output Voltage Selection.
18	V _{E2}	Output Enable 2. When V _{E2} is high or disconnected, the V _{OA} , V _{OB} , V _{OC} , and V _{OD} outputs are enabled. When V _{E2} is low, the V _{OA} , V _{OB} , V _{OC} , and V _{OD} outputs are disabled. In noisy environments, connecting V _{E2} to either an external logic high or logic low is recommended.
19	V _{OD}	Logic Output D.
20	V _{OC}	Logic Output C.
21	V _{OB}	Logic Output B.
22	V _{OA}	Logic Output A.
24	V _{DD2}	Power Supply for the Side 2 Logic Circuits of the Device. This pin is independent of V _{DDP} and operates between 3.0 V and 5.5 V.

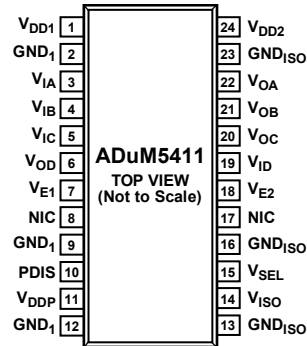

NIC = NO INTERNAL CONNECTION.
LEAVE THESE PINS FLOATING.

14895F-004

Figure 4. ADuM5411 Pin Configuration

Table 29. ADuM5411 Pin Function Descriptions

Pin No.	Mnemonic	Description
1	V _{DD1}	Power Supply for the Side 1 Logic Circuits of the Device. This pin is independent of V _{DDP} and operates between 3.0 V and 5.5 V.
2, 9, 12	GND ₁	Ground 1. Ground reference for the primary isolator. Pin 2, Pin 9, and Pin 12 are internally connected, and it is recommended that these pins be connected to a common ground.
3	V _{IA}	Logic Input A.
4	V _{IB}	Logic Input B.
5	V _{IC}	Logic Input C.
6	V _{OD}	Logic Output D.
7	V _{E1}	Output Enable 1. When V _{E1} is high or disconnected, the V _{OD} output is enabled. When V _{E1} is low, the V _{OD} output is disabled. In noisy environments, connecting V _{E1} to either an external logic high or logic low is recommended.
8, 17	NIC	No Internal Connection. Leave these pins floating.
10	PDIS	Power Disable. When tied to any GND ₁ pin, the power converter is active; when a logic high voltage is applied, the power supply enters a low power standby mode.
11	V _{DDP}	Primary Supply Voltage, 3.0 V to 5.5 V.
13, 16, 23	GND _{ISO}	Ground Reference for V _{DD2} and V _{ISO} on Side 2. Pin 13, Pin 16, and Pin 23 are internally connected, and it is recommended that these pins be connected to a common ground.
14	V _{ISO}	Secondary Supply Voltage Output for External Loads. Connect to V _{DD2} to power the isolator channels.
15	V _{SEL}	Output Voltage Selection.
18	V _{E2}	Output Enable 2. When V _{E2} is high or disconnected, the V _{OA} , V _{OB} , and V _{OC} outputs are enabled. When V _{E2} is low, the V _{OA} , V _{OB} , and V _{OC} outputs are disabled. In noisy environments, connecting V _{E2} to either an external logic high or logic low is recommended.
19	V _{ID}	Logic Input D.
20	V _{OC}	Logic Output C.
21	V _{OB}	Logic Output B.
22	V _{OA}	Logic Output A.
24	V _{DD2}	Power Supply for the Side 2 Logic Circuits of the Device. This pin is independent of V _{DDP} and operates between 3.0 V and 5.5 V.

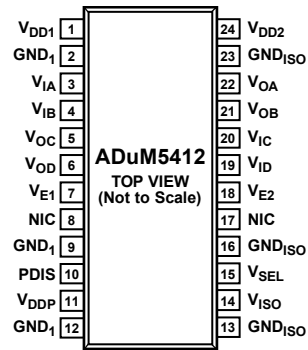

NIC = NO INTERNAL CONNECTION.
LEAVE THESE PINS FLOATING.

1489E-005

Figure 5. ADuM5412 Pin Configuration

Table 30. ADuM5412 Pin Function Descriptions

Pin No.	Mnemonic	Description
1	V _{DD1}	Power Supply for the Side 1 Logic Circuits of the Device. This pin is independent of V _{DDP} and operates between 3.0V and 5.5V.
2, 9, 12	GND ₁	Ground 1. Ground reference for the primary isolator. Pin 2, Pin 9, and Pin 12 are internally connected, and it is recommended that these pins be connected to a common ground.
3	V _{IA}	Logic Input A.
4	V _{IB}	Logic Input B.
5	V _{OC}	Logic Output C.
6	V _{OD}	Logic Output D.
7	V _{E1}	Output Enable 1. When V _{E1} is high or disconnected, the V _{OC} and V _{OD} outputs are enabled. When V _{E1} is low, the V _{OC} and V _{OD} outputs are disabled. In noisy environments, connecting V _{E1} to either an external logic high or logic low is recommended.
8, 17	NIC	No Internal Connection. Leave these pins floating.
10	PDIS	Power Disable. When tied to any GND ₁ pin, the power converter is active; when a logic high voltage is applied, the power supply enters a low power standby mode.
11	V _{DDP}	Primary Supply Voltage, 3.0V to 5.5V.
13, 16, 23	GND _{ISO}	Ground Reference for V _{DD2} and V _{ISO} on Side 2. Pin 13, Pin 16, and Pin 23 are internally connected, and it is recommended that these pins be connected to a common ground.
14	V _{ISO}	Secondary Supply Voltage Output for External Loads. Connect to V _{DD2} to power the isolator channels.
15	V _{SEL}	Output Voltage Selection.
18	V _{E2}	Output Enable 2. When V _{E2} is high or disconnected, the V _{OA} and V _{OB} outputs are enabled. When V _{E2} is low, the V _{OA} and V _{OB} outputs are disabled. In noisy environments, connecting V _{E2} to either an external logic high or logic low is recommended.
19	V _{ID}	Logic Input D.
20	V _{IC}	Logic Input C.
21	V _{OB}	Logic Output B.
22	V _{OA}	Logic Output A.
24	V _{DD2}	Power Supply for the Side 2 Logic Circuits of the Device. This pin is independent of V _{DDP} and operates between 3.0V and 5.5V.

TRUTH TABLES

Table 31. Truth Table (Positive Logic)

V _{DDP} (V)	V _{SEL} Input	PDIS Input Logic	V _{ISO} Output (V)	Notes
5	R1 = 10 kΩ, R2 = 30.9 kΩ	Low	5	This configuration is not recommended
5	R1 = 10 kΩ, R2 = 30.9 kΩ	High	0	
3.3	R1 = 10 kΩ, R2 = 16.9 kΩ	Low	3.3	
3.3	R1 = 10 kΩ, R2 = 16.9 kΩ	High	0	
5	R1 = 10 kΩ, R2 = 16.9 kΩ	Low	3.3	
5	R1 = 10 kΩ, R2 = 16.9 kΩ	High	0	
3.3	R1 = 10 kΩ, R2 = 30.9 kΩ	Low	5	
3.3	R1 = 10 kΩ, R2 = 30.9 kΩ	High	0	

Table 32. Data Section Truth Table (Positive Logic)

V _{DDI} State ¹	V _{IX} Input ¹	V _{DDO} State ¹	V _{OX} Output ¹	Notes
Powered	High	Powered	High	Normal operation, data is high
Powered	Low	Powered	Low	Normal operation, data is low
Don't care	Don't care	Unpowered	High-Z	Output is off
Unpowered	Low	Powered	Low	Output default low
Unpowered	High	Powered	Indeterminate	If a high level is applied to an input when no supply is present, the input can parasitically power the input side, causing unpredictable operation

¹ V_{DDI} and V_{DDO} refer to the supply voltages on the input and output sides of the given channel, respectively. V_{IX} and V_{OX} refer to the input and output signals of a given channel (Channel A, Channel B, Channel C, or Channel D).

TYPICAL PERFORMANCE CHARACTERISTICS

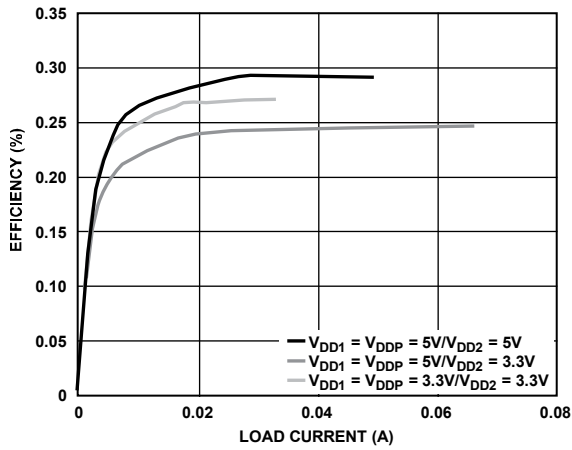

Figure 6. Power Supply Efficiency at 5 V/5 V, 5 V/3.3 V, and 3.3 V/3.3 V

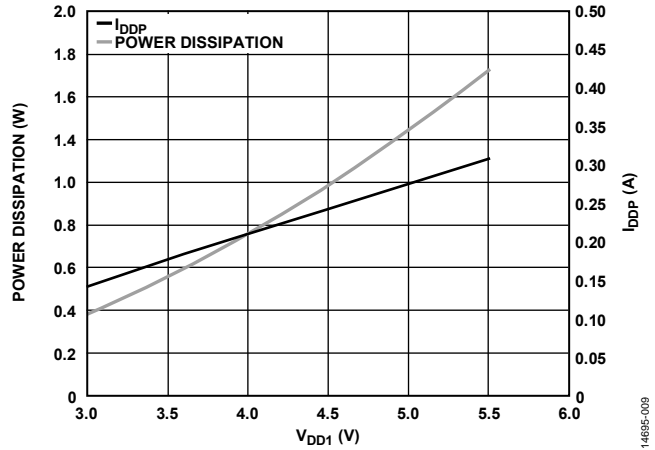

Figure 9. Short-Circuit Input Current (I_{DDP}) and Power Dissipation vs. V_{DD1} Supply Voltage

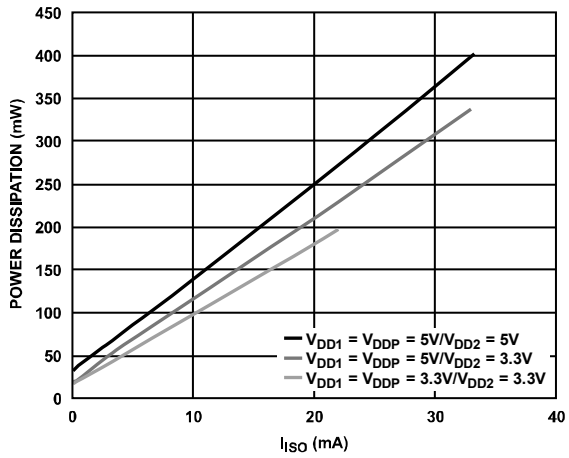

Figure 7. Total Power Dissipation vs. Output Supply Current, I_{ISO} , with Data Channels Idle

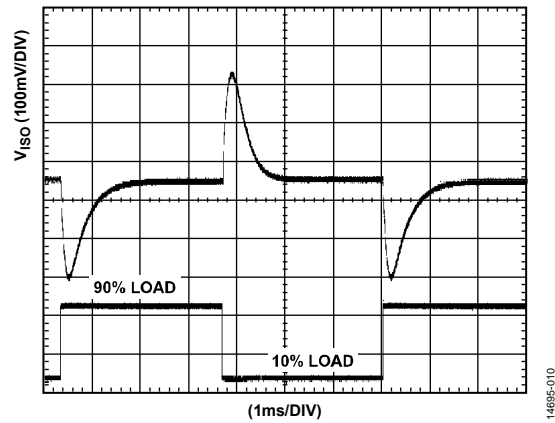

Figure 10. V_{ISO} Transient Load Response, 5 V Output, 10% to 90% Load Step

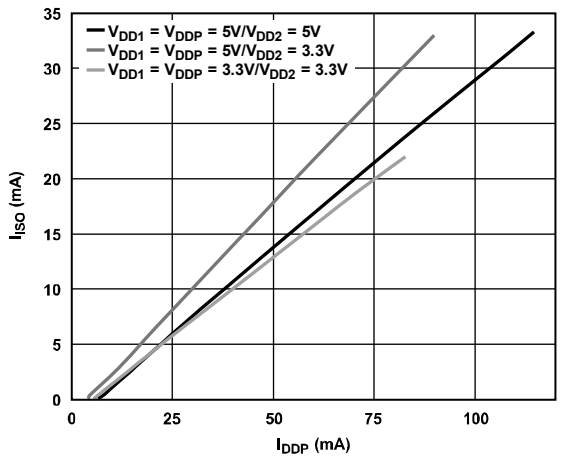

Figure 8. Isolated I_{ISO} as a Function of External Load, No Dynamic Current Draw at 5 V/5 V, 5 V/3.3 V, and 3.3 V/3.3 V

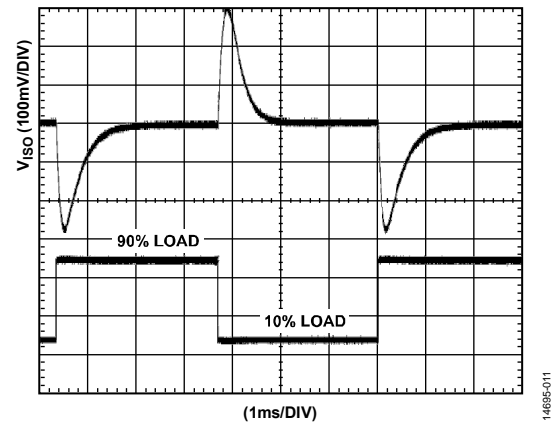

Figure 11. Transient Load Response, 3 V Output, 10% to 90% Load Step

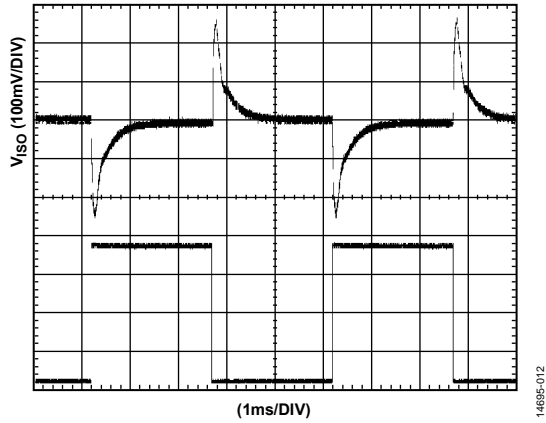

Figure 12. Transient Load Response, 5 V Input, 3.3 V Output, 10% to 90% Load Step

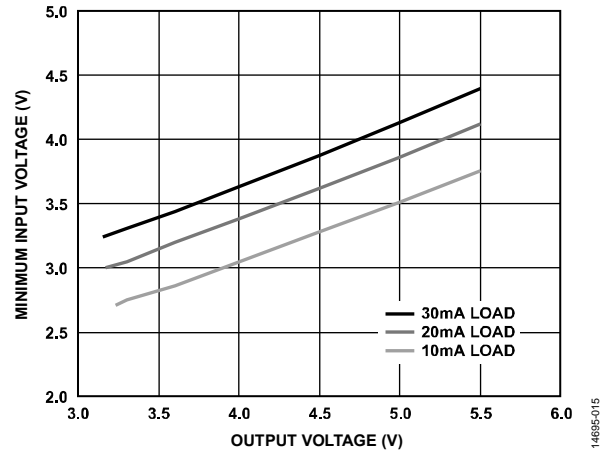

Figure 15. Relationship Between Output Voltage and Required Input Voltage, Under Load, to Maintain >80% Duty Factor in the PWM

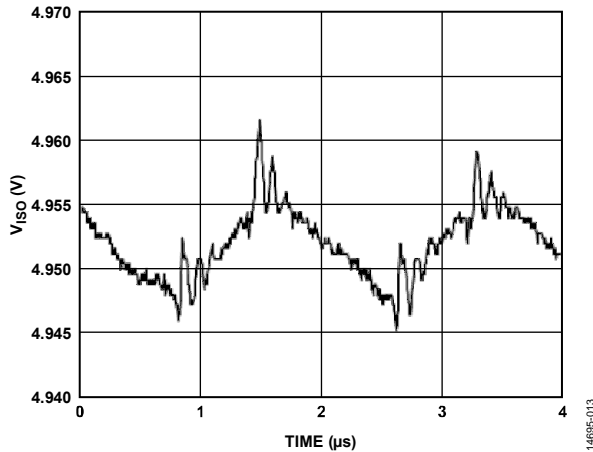

Figure 13. Output Voltage Ripple at 90% Load, $V_{ISO} = 5 V$

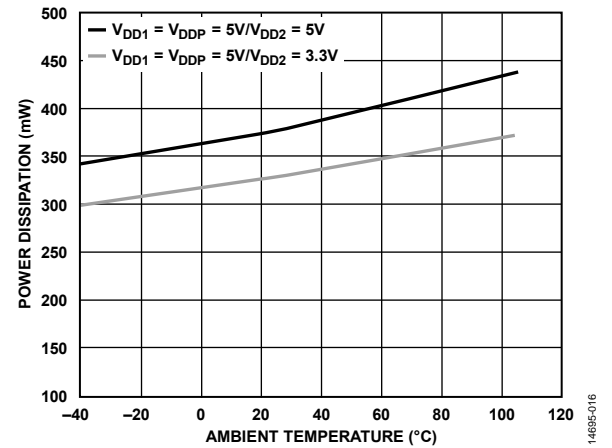

Figure 16. Power Dissipation vs. Ambient Temperature with a 30 mA Load

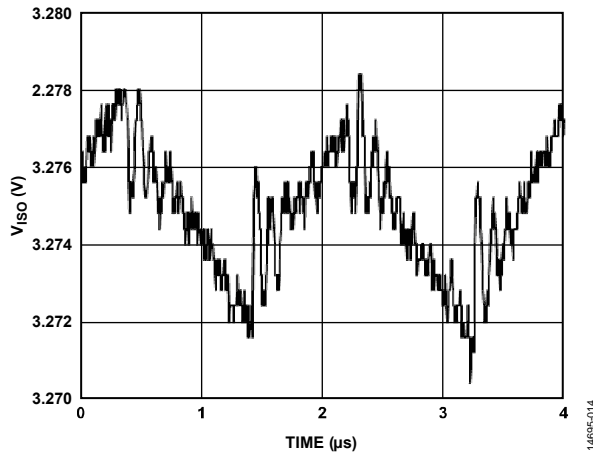

Figure 14. Output Voltage Ripple at 90% Load, $V_{ISO} = 3.3 V$

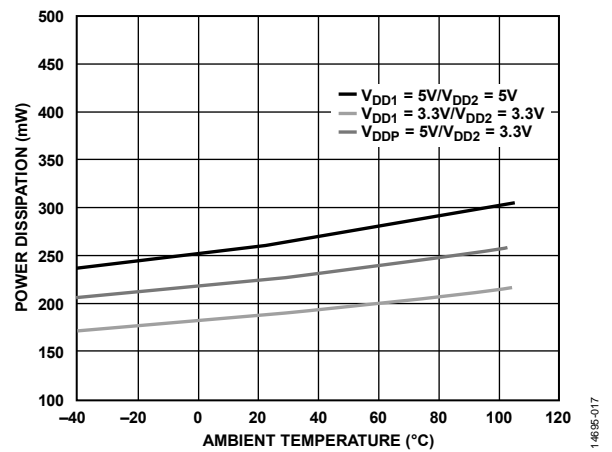

Figure 17. Power Dissipation vs. Ambient Temperature with a 20 mA Load

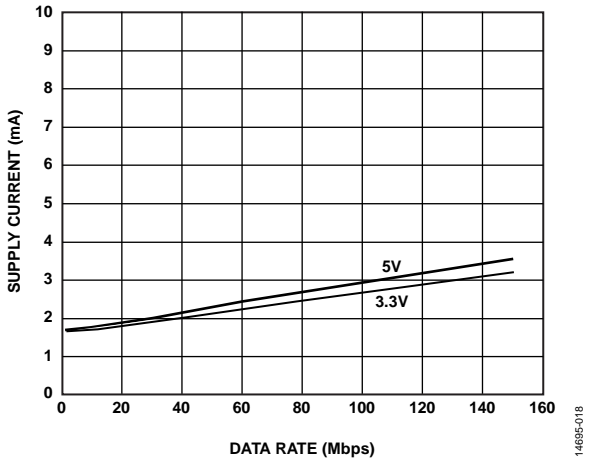

Figure 18. Supply Current per Input Channel vs. Data Rate for 5 V and 3.3 V Operation

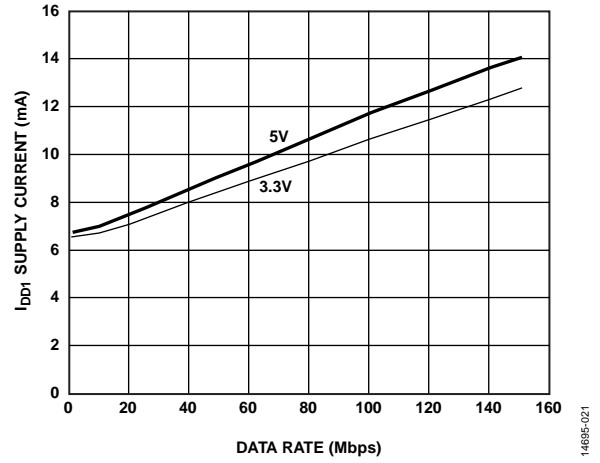

Figure 21. ADuM5410 V_{DD1} Supply Current (I_{DD1}) vs. Data Rate for 5 V and 3.3 V Operation

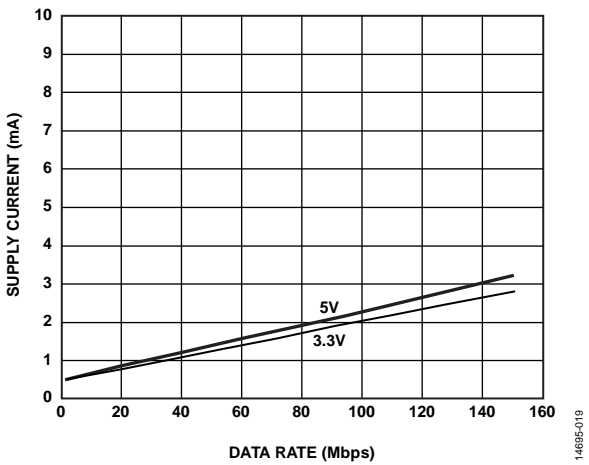

Figure 19. Supply Current per Output Channel vs. Data Rate for 5 V and 3.3 V Operation (No Output Load)

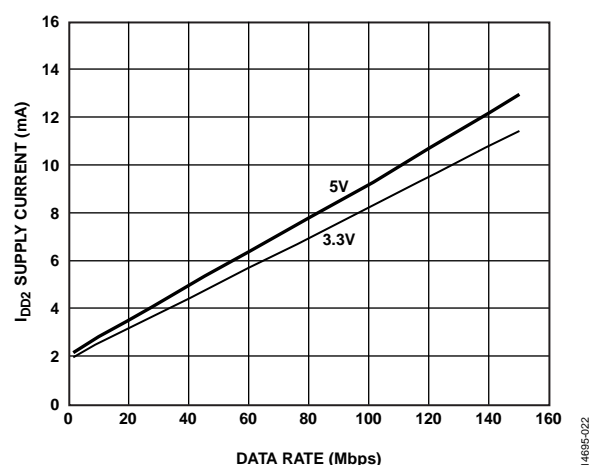

Figure 22. ADuM5410 V_{DD2} Supply Current (I_{DD2}) vs. Data Rate for 5 V and 3.3 V Operation

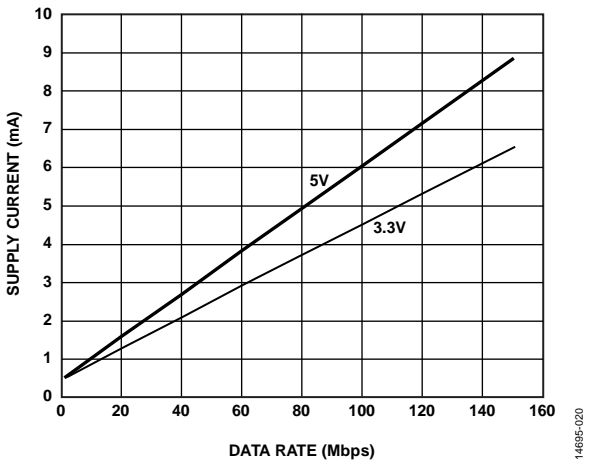

Figure 20. Supply Current per Output Channel vs. Data Rate for 5 V and 3.3 V Operation (15 pF Output Load)

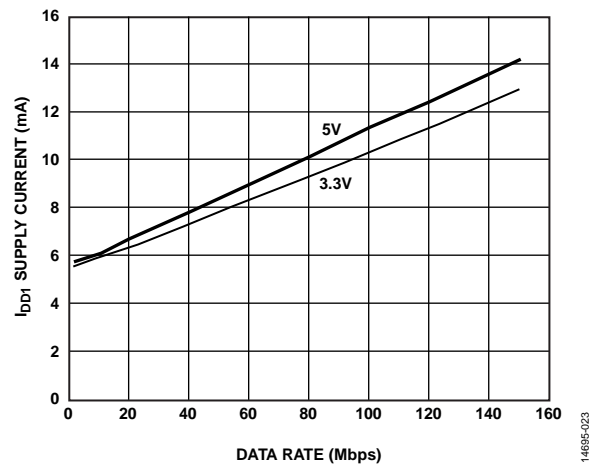

Figure 23. ADuM5411 V_{DD1} Supply Current (I_{DD1}) vs. Data Rate for 5 V and 3.3 V Operation

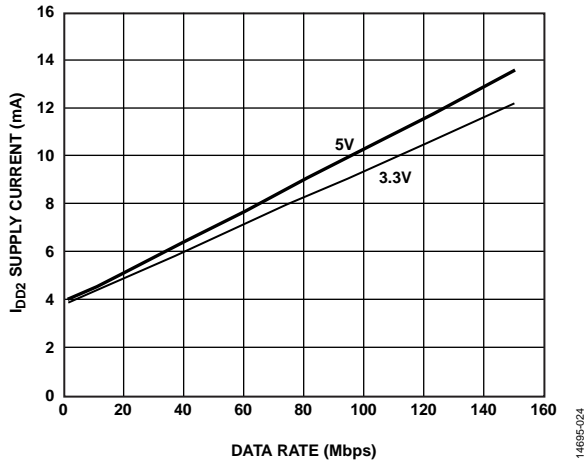

Figure 24. ADuM5411 V_{DD2} Supply Current (I_{DD2}) vs. Data Rate for 5 V and 3.3 V Operation

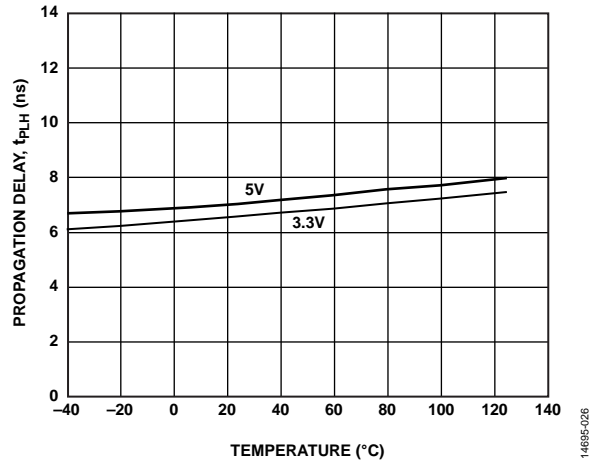

Figure 27. Propagation Delay, t_{PLH} vs. Temperature for 5 V and 3.3 V Operation

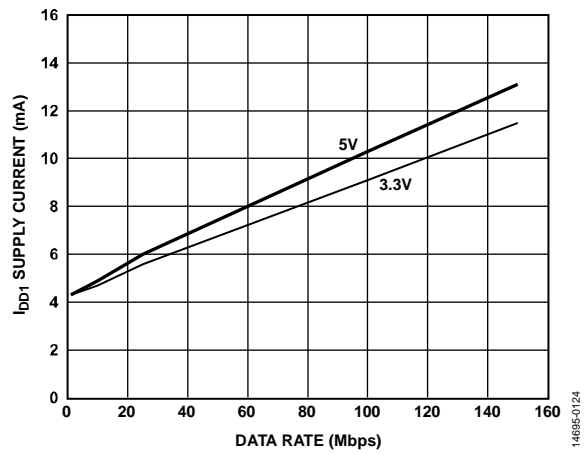

Figure 25. ADuM5412 V_{DD1} Supply Current (I_{DD1}) vs. Data Rate for 5 V and 3.3 V Operation

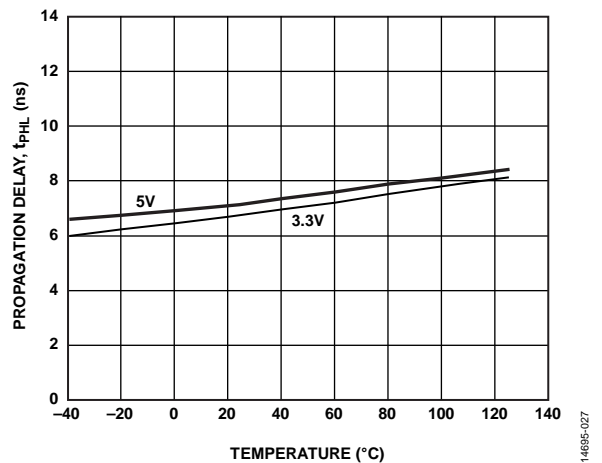

Figure 28. Propagation Delay, t_{PLH} vs. Temperature for 5 V and 3.3 V Operation

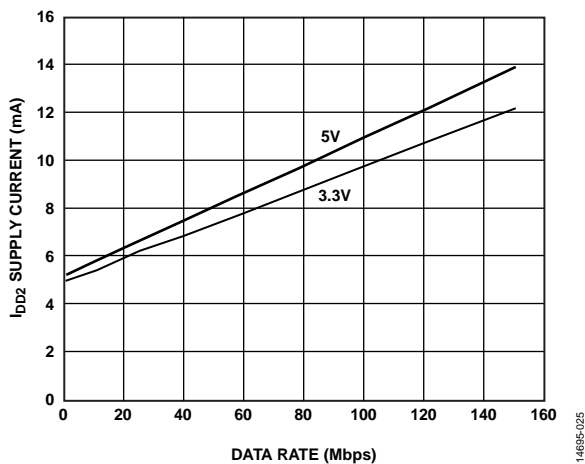

Figure 26. ADuM5412 V_{DD2} Supply Current (I_{DD2}) vs. Data Rate for 5 V and 3.3 V Operation

TERMINOLOGY

$I_{DD1(Q)}$

$I_{DD1(Q)}$ is the minimum operating current drawn at the V_{DD1} pin when there is no external load at V_{ISO} and the input/output pins are operating below 2 Mbps, requiring no additional dynamic supply current. $I_{DD1(Q)}$ reflects the minimum current operating condition.

$I_{DD1(D)}$

$I_{DD1(D)}$ is the typical input supply current with all channels simultaneously driven at a maximum data rate of 33 Mbps with full capacitive load representing the maximum dynamic load conditions. Treat resistive loads on the outputs separately from the dynamic load.

$I_{DD1(MAX)}$

$I_{DD1(MAX)}$ is the input current under full dynamic and V_{ISO} load conditions.

$I_{SO(LOAD)}$

$I_{SO(LOAD)}$ is the current available to load.

Propagation Delay, t_{PHL}

t_{PHL} propagation delay is measured from the 50% level of the falling edge of the V_{IX} signal to the 50% level of the falling edge of the V_{OX} signal.

Propagation Delay, t_{PLH}

t_{PLH} propagation delay is measured from the 50% level of the rising edge of the V_{IX} signal to the 50% level of the rising edge of the V_{OX} signal.

Propagation Delay Skew, t_{PSK}

t_{PSK} is the magnitude of the worst-case difference in t_{PHL} and/or t_{PLH} that is measured between units at the same operating temperature, supply voltages, and output load within the recommended operating conditions.

Channel to Channel Matching, t_{PSKCD}/t_{PSKOD}

Channel to channel matching is the absolute value of the difference in propagation delays between the two channels when operated with identical loads.

Minimum Pulse Width

The minimum pulse width is the shortest pulse width at which the specified pulse width distortion is guaranteed.

Maximum Data Rate

The maximum data rate is the fastest data rate at which the specified pulse width distortion is guaranteed.

THEORY OF OPERATION

The dc-to-dc converter section of the [ADuM5410/ADuM5411/ADuM5412](#) works on principles that are common to most modern power supplies. It has a split controller architecture with isolated PWM feedback. V_{DDP} power is supplied to an oscillating circuit that switches current into a chip-scale air core transformer. Power transferred to the secondary side is rectified and regulated to a value between 3.15 V and 5.25 V, depending on the setpoint supplied by an external voltage divider (see Equation 1). The secondary (V_{ISO}) side controller regulates the output by creating a PWM control signal that is sent to the primary (V_{DDP}) side by a dedicated *iCoupler* data channel. The PWM modulates the oscillator circuit to control the power being sent to the secondary side. Feedback allows for significantly higher power and efficiency.

$$V_{ISO} = 1.225 \text{ V} \frac{(R1 + R2)}{R1} \quad (1)$$

where:

$R1$ is a resistor between V_{SEL} and GND_{ISO} .

$R2$ is a resistor between V_{SEL} and V_{ISO} .

Because the output voltage can be adjusted continuously, there are an infinite number of operating conditions. This data sheet addresses three discrete operating conditions in the Specifications section. Many other combinations of input and output voltage are possible; Figure 15 shows the supported voltage combinations at room temperature. Figure 15 was generated by fixing the V_{ISO} load and decreasing the input voltage until the PWM was at 80% duty cycle. Each of the figures represents the minimum input voltage that is required for operation under this criterion. For example, if the application requires 30 mA of output current at 5 V, the minimum input voltage at V_{DDP} is 4.25 V. Figure 15 also illustrates why the $V_{DDP} = 3.3 \text{ V}$ input and $V_{ISO} = 5 \text{ V}$ configuration is not recommended. Even at 10 mA of output current, the PWM

cannot maintain less than 80% duty factor, leaving no margin to support load or temperature variations.

Typically, the [ADuM5410/ADuM5411/ADuM5412](#) dissipate about 17% more power between room temperature and maximum temperature; therefore, the 20% PWM margin covers temperature variations.

The [ADuM5410/ADuM5411/ADuM5412](#) implement undervoltage lockout (UVLO) with hysteresis on the primary and secondary side input/output pins as well as the V_{DDP} power input. This feature ensures that the converters do not go into oscillation due to noisy input power or slow power-on ramp rates.

The digital isolator channels use a high frequency carrier to transmit data across the isolation barrier using *iCoupler* chip scale transformer coils separated by layers of polyimide isolation. Using an on/off keying (OOK) technique and the differential architecture shown in Figure 29, the digital isolator channels have very low propagation delay and high speed. Internal regulators and input/output design techniques allow logic and supply voltages over a wide range from 1.7 V to 5.5 V, offering voltage translation of 1.8 V, 2.5 V, 3.3 V, and 5 V logic. The architecture is designed for high common-mode transient immunity and high immunity to electrical noise and magnetic interference. Radiated emissions are minimized with a spread spectrum OOK carrier and other techniques.

Figure 29 shows the waveforms of the digital isolator channels that have the condition of the fail-safe output state equal to low, where the carrier waveform is off when the input state is low. If the input side is off or not operating, the low fail-safe output state sets the output to low.

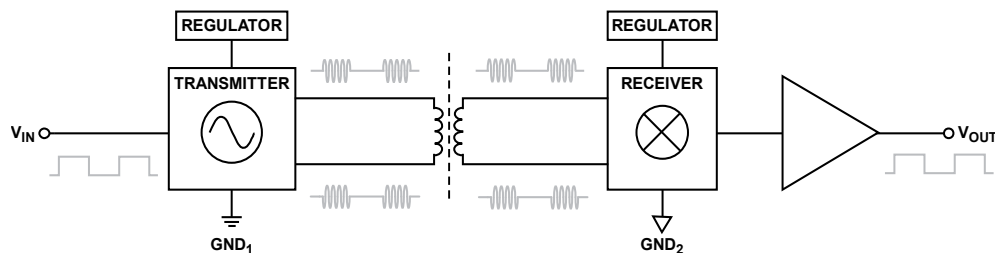

Figure 29. Operational Block Diagram of a Single Channel with a Low Fail-Safe Output State

APPLICATIONS INFORMATION

PCB LAYOUT

The ADuM5410/ADuM5411/ADuM5412 digital isolators with 0.15 W isoPower integrated dc-to-dc converters require no external interface circuitry for the logic interfaces. Power supply bypassing is required at the input and output supply pins (see Figure 32). Note that low ESR bypass capacitors of 0.01 μF to 0.1 μF value are required between the V_{DD1} pin and GND_1 pin, and between the V_{DD2} pin and GND_{ISO} pin, as close to the chip pads as possible, for proper operation of the data channels. The isoPower inputs require several passive components to bypass the power effectively, as well as set the output voltage and bypass the core voltage regulator (see Figure 30 through Figure 32).

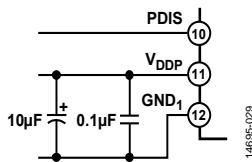

Figure 30. V_{DDP} Bias and Bypass Components

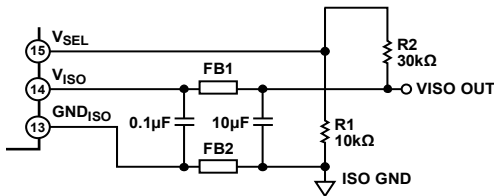

Figure 31. V_{ISO} Bias and Bypass Components

The power supply section of the ADuM5410/ADuM5411/ADuM5412 uses a 125 MHz oscillator frequency to efficiently pass power through its chip-scale transformers. Bypass capacitors are required for several operating frequencies. Noise suppression requires a low inductance, high frequency capacitor; ripple suppression and proper regulation require a large value capacitor. These capacitors are most conveniently connected between the V_{DDP} pin and GND_1 pin, and between the V_{ISO} pin and GND_{ISO} pin. To suppress noise and reduce ripple, a parallel combination of at least two capacitors is required. The recommended capacitor values are 0.1 μF and 10 μF for V_{DD1} . The smaller capacitor must have a low ESR; for example, use of a ceramic capacitor is advised. Note that the total lead length between the ends of the low ESR capacitor and the input power supply pin must not exceed 2 mm. Installing the bypass capacitor with traces more than 2 mm in length may result in data corruption.

To reduce the level of electromagnetic radiation, the impedance to high frequency currents between the V_{ISO} and GND_{ISO} pins and the PCB trace connections can be increased. Using this method of EMI suppression controls the radiating signal at its source by placing surface-mount ferrite beads in series with the V_{ISO} and GND_{ISO} pins, as seen in Figure 32. The impedance of the ferrite bead is chosen to be about 2 k Ω between the 100 MHz and 1 GHz frequency range, to reduce the emissions at the 125 MHz primary switching frequency and the 250 MHz secondary side rectifying frequency and harmonics. See Table 33 for examples of appropriate surface-mount ferrite beads. For additional reduction in emissions, PCB stitching capacitance can be implemented with a high voltage SMT safety capacitor. For optimal performance, it is important that the capacitor is connected directly between GND_1 (Pin 12) and GND_{ISO} (Pin 13), as shown in Figure 32. This capacitor is a SMT Size 1812, has a 3 kV voltage rating, and is manufactured by TDK Corporation (C4532C0G3F101K160KA).

Table 33. Surface-Mount Ferrite Beads Example

Manufacturer	Part No.
Taiyo Yuden	BKH1005LM182-T
Murata Electronics	BLM15HD182SN1

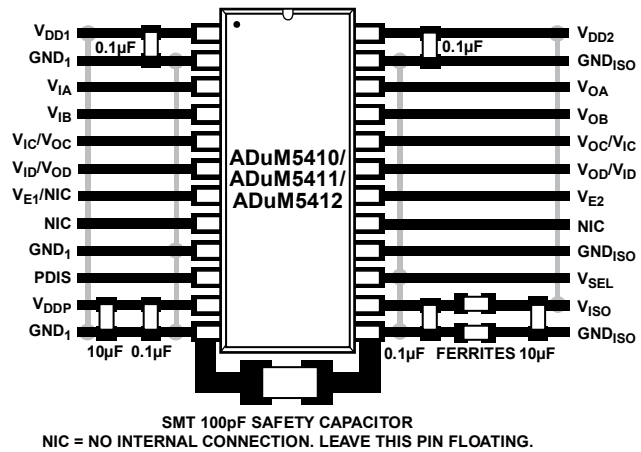

Figure 32. Recommended PCB Layout

In applications involving high common-mode transients, ensure that board coupling across the isolation barrier is minimized. Furthermore, design the board layout such that any coupling that does occur equally affects all pins on a given component side. Failure to ensure these steps can cause voltage differentials between pins, exceeding the absolute maximum ratings specified in Table 26, thereby leading to latch-up and/or permanent damage.

THERMAL ANALYSIS

The ADuM5410/ADuM5411/ADuM5412 consist of four internal die attached to a split lead frame with two die attach pads. For the purposes of thermal analysis, the die is treated as a thermal unit, with the highest junction temperature reflected in the θ_{JA} value from Table 21. The value of θ_{JA} is based on measurements taken with the devices mounted on a JEDEC standard, 4-layer board with fine width traces and still air. Under normal operating conditions, the ADuM5410/ADuM5411/ADuM5412 can operate at full load across the full temperature range without derating the output current.

PROPAGATION DELAY RELATED PARAMETERS

Propagation delay is a parameter that describes the time it takes a logic signal to propagate through a component (see Figure 33). The propagation delay to a logic low output may differ from the propagation delay to a logic high.

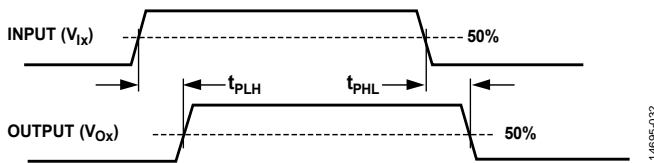

Figure 33. Propagation Delay Parameters

Pulse width distortion is the maximum difference between these two propagation delay values and is an indication of how accurately the input signal timing is preserved.

Channel to channel matching refers to the maximum amount the propagation delay differs between channels within a single ADuM5410/ADuM5411/ADuM5412 component.

Propagation delay skew refers to the maximum amount the propagation delay differs between multiple ADuM5410/ADuM5411/ADuM5412 components operating under the same conditions.

EMI CONSIDERATIONS

The dc-to-dc converter section of the ADuM5410/ADuM5411/ADuM5412 components must, of necessity, operate at a very high frequency to allow efficient power transfer through the small transformers, which creates high frequency currents that can propagate in circuit board ground and power planes, causing edge and dipole radiation. Grounded enclosures are recommended for applications that use these devices. If grounded enclosures are not possible, follow good RF design practices in the layout of the PCB. Follow the layout techniques described in the PCB Layout section. See the AN-0971 Application Note for the most current PCB layout recommendations for the ADuM5410/ADuM5411/ADuM5412.

POWER CONSUMPTION

The V_{DDP} power supply input only provides power to the converter. Power for the data channels is provided through V_{DD1} and V_{DD2} . These power supplies can be connected to V_{DDP} and V_{ISO} if desired, or the supplies can receive power from an independent source.

Treat the converter as a standalone supply to be utilized at the discretion of the designer.

The V_{DD1} or V_{DD2} supply current at a given channel of the ADuM5410/ADuM5411/ADuM5412 isolator is a function of the supply voltage, the data rate of the channel, and the output load of the channel.

To calculate the total V_{DD1} and V_{DD2} supply current, the supply currents for each input and output channel corresponding to V_{DD1} and V_{DD2} are calculated and totaled. Figure 18 and Figure 19 show per channel supply currents as a function of data rate for an unloaded output condition. Figure 20 shows the per channel supply current as a function of data rate for a 15 pF output condition. Figure 21 through Figure 26 show the total V_{DD1} and V_{DD2} supply current as a function of data rate for ADuM5410/ADuM5411/ADuM5412 channel configurations.

INSULATION LIFETIME

All insulation structures eventually break down when subjected to voltage stress over a sufficiently long period. The rate of insulation degradation is dependent on the characteristics of the voltage waveform applied across the insulation as well as on the materials and material interfaces.

The two types of insulation degradation of primary interest are breakdown along surfaces exposed to the air and insulation wear out. Surface breakdown is the phenomenon of surface tracking and the primary determinant of surface creepage requirements in system level standards. Insulation wear out is the phenomenon where charge injection or displacement currents inside the insulation material cause long-term insulation degradation.

Surface Tracking

Surface tracking is addressed in electrical safety standards by setting a minimum surface creepage based on the working voltage, the environmental conditions, and the properties of the insulation material. Safety agencies perform characterization testing on the surface insulation of components that allows the components to be categorized in different material groups. Lower material group ratings are more resistant to surface tracking and, therefore, can provide adequate lifetime with smaller creepage. The minimum creepage for a given working voltage and material group is in each system level standard and is based on the total rms voltage across the isolation, pollution degree, and material group. The material group and creepage for the digital isolator channels are presented in Table 23.

Insulation Wear Out

The lifetime of insulation caused by wear out is determined by its thickness, material properties, and the voltage stress applied. It is important to verify that the product lifetime is adequate at the application working voltage. The working voltage supported by an isolator for wear out may not be the same as the working voltage supported for tracking. The working voltage applicable to tracking is specified in most standards.

Testing and modeling show that the primary driver of long-term degradation is displacement current in the polyimide insulation causing incremental damage. The stress on the insulation can be broken down into broad categories, such as dc stress, which causes very little wear out because there is no displacement current, and an ac component time varying voltage stress, which causes wear out.

The ratings in certification documents are usually based on 60 Hz sinusoidal stress because this reflects isolation from line voltage. However, many practical applications have combinations of 60 Hz ac and dc across the barrier as shown in Equation 1. Because only the ac portion of the stress causes wear out, the equation can be rearranged to solve for the ac rms voltage, as is shown in Equation 2. For insulation wear out with the polyimide materials used in these products, the ac rms voltage determines the product lifetime.

$$V_{RMS} = \sqrt{V_{ACRMS}^2 + V_{DC}^2} \quad (1)$$

or

$$V_{ACRMS} = \sqrt{V_{RMS}^2 - V_{DC}^2} \quad (2)$$

where:

V_{ACRMS} is the time varying portion of the working voltage.

V_{RMS} is the total rms working voltage.

V_{DC} is the dc offset of the working voltage.

Calculation and Use of Parameters Example

The following example frequently arises in power conversion applications. Assume that the line voltage on one side of the isolation is 240 V ac rms and a 400 V dc bus voltage is present on the other side of the isolation barrier. The isolator material is polyimide. To establish the critical voltages in determining the creepage, clearance and lifetime of a device, see Figure 34 and the following equations.

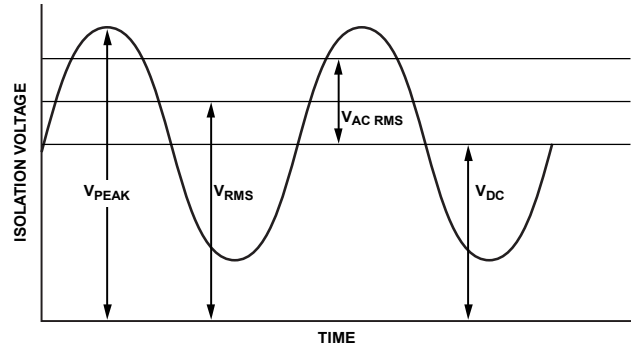

Figure 34. Critical Voltage Example

The working voltage across the barrier from Equation 1 is

$$V_{RMS} = \sqrt{V_{ACRMS}^2 + V_{DC}^2}$$

$$V_{RMS} = \sqrt{240^2 + 400^2}$$

$$V_{RMS} = 466 \text{ V}$$

This V_{RMS} value is the working voltage used together with the material group and pollution degree when looking up the creepage required by a system standard.

To determine if the lifetime is adequate, obtain the time varying portion of the working voltage. To obtain the ac rms voltage, use Equation 2.

$$V_{ACRMS} = \sqrt{V_{RMS}^2 - V_{DC}^2}$$

$$V_{ACRMS} = \sqrt{466^2 - 400^2}$$

$$V_{ACRMS} = 240 \text{ V rms}$$

In this case, the ac rms voltage is simply the line voltage of 240 V rms. This calculation is more relevant when the waveform is not sinusoidal. The value is compared to the limits for working voltage in Table 27 for the expected lifetime, which is less than a 60 Hz sine wave, and it is well within the limit for a 50-year service life.

Note that the dc working voltage limit is set by the creepage of the package as specified in IEC 60664-1. This value can differ for specific system level standards.

OUTLINE DIMENSIONS

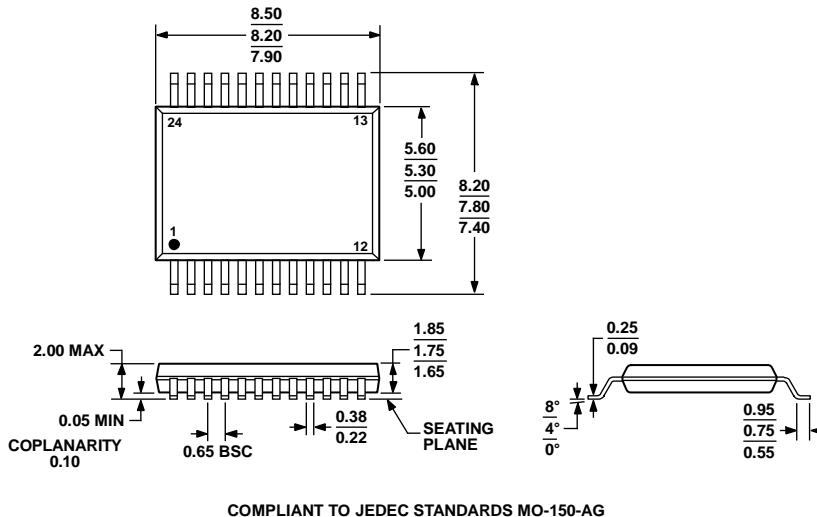

COMPLIANT TO JEDEC STANDARDS MO-150-AG
 Figure 35. 24-Lead Shrink Small Outline Package [SSOP] (RS-24)
 Dimensions shown in millimeters

ORDERING GUIDE

Model ¹	Number of Inputs, V _{DD1} Side	Number of Inputs, V _{ISO} Side	Maximum Data Rate (Mbps)	Maximum Propagation Delay, 5 V (ns)	Maximum Pulse Width Distortion (ns)	Temperature Range (°C)	Package Description	Package Option
ADuM5410BRSZ	4	0	150	13	3	-40 to +105	24-Lead SSOP	RS-24
ADuM5410BRSZ-RL7	4	0	150	13	3	-40 to +105	24-Lead SSOP	RS-24
ADuM5411BRSZ	3	1	150	13	3	-40 to +105	24-Lead SSOP	RS-24
ADuM5411BRSZ-RL7	3	1	150	13	3	-40 to +105	24-Lead SSOP	RS-24
ADuM5412BRSZ	2	2	150	13	3	-40 to +105	24-Lead SSOP	RS-24
ADuM5412BRSZ-RL7	2	2	150	13	3	-40 to +105	24-Lead SSOP	RS-24
EVAL-ADuM5411EBZ							Evaluation Board ²	
EVAL-ADuM5411UEBZ							Evaluation Board ³	

¹ Z = RoHS Compliant Part.
² The EVAL-ADuM5411EBZ is packaged with the ADuM5411BRSZ installed.
³ The EVAL-ADuM5411UEBZ is packaged without an ADuM5411 installed.

Mouser Electronics

Authorized Distributor

Click to View Pricing, Inventory, Delivery & Lifecycle Information:

[Analog Devices Inc.:](#)

[ADUM5412BRSZ](#) [ADUM5411BRSZ](#) [ADUM5410BRSZ](#) [ADUM5410BRSZ-RL7](#) [ADUM5411BRSZ-RL7](#)
[ADUM5412BRSZ-RL7](#)