

# 16-Bit, 2.5Msps SAR ADC with Pin-Configurable Analog Input Range and 96dB SNR

## FEATURES

- 2.5Msps Throughput Rate
- $\pm 1$ LSB INL (Max)
- Guaranteed 16-Bit, No Missing Codes
- Pin-Configurable Analog Input Range:
  - ±4.096V Fully Differential
  - 0V to 4.096V Pseudo-Differential Unipolar
  - ±2.048V Pseudo-Differential Bipolar
- 96.0dB (Fully Differential)/93.5dB (Pseudo Differential) SNR (Typ) at  $f_{IN} = 2$ kHz
- -116dB (Fully Differential)/-112dB (Pseudo Differential) THD (Typ) at  $f_{IN} = 2$ kHz
- Guaranteed Operation to 125°C
- Single 5V Supply
- Internal 20ppm/°C (Max) Reference
- Internal Reference Buffer
- 162.5mW Power Dissipation at 2.5Msps
- No Pipeline Delay, No Cycle Latency
- 1.8V to 5V I/O Voltages
- Parallel and Serial I/O Interface
- 48-pin 7mm × 7mm LQFP and QFN Packages

## APPLICATIONS

- Medical Imaging
- High Speed, Wide Dynamic Range Data Acquisition
- Industrial Process Control
- Instrumentation
- ATE

## DESCRIPTION

The LTC<sup>®</sup>2389-16 is a low noise, high speed 16-bit successive approximation register (SAR) ADC. Operating from a single 5V supply, the LTC2389-16 supports pin-configurable fully differential ( $\pm 4.096$ V), pseudo-differential unipolar (0V to 4.096V), and pseudo-differential bipolar ( $\pm 2.048$ V) analog input ranges, allowing it to interface with multiple signal chain formats without requiring additional level translation or signal conditioning. The LTC2389-16 achieves  $\pm 1$ LSB INL (maximum), no missing codes at 16-bits, and 96.0dB (fully differential)/93.5dB (pseudo differential) SNR (typical).

The LTC2389-16 includes a precision internal 4.096V reference, with a guaranteed 0.5% initial accuracy and a  $\pm 20$ ppm/°C (maximum) temperature coefficient, as well as an internal reference buffer. Fast 2.5Msps throughput with no cycle latency in the parallel interface modes makes the LTC2389-16 ideally suited for a wide variety of high speed applications. An internal oscillator sets the conversion time, easing external timing considerations. The LTC2389-16 dissipates only 162.5mW at 2.5Msps, while both nap and sleep power-down modes are provided to further reduce power consumption during inactive periods.

LT, LT, LTC, LTM, Linear Technology and the Linear logo are registered trademarks and SoftSpan is a trademark of Linear Technology Corporation. All other trademarks are the property of their respective owners. Protected by U.S. Patents, including 7705765.

## TYPICAL APPLICATION

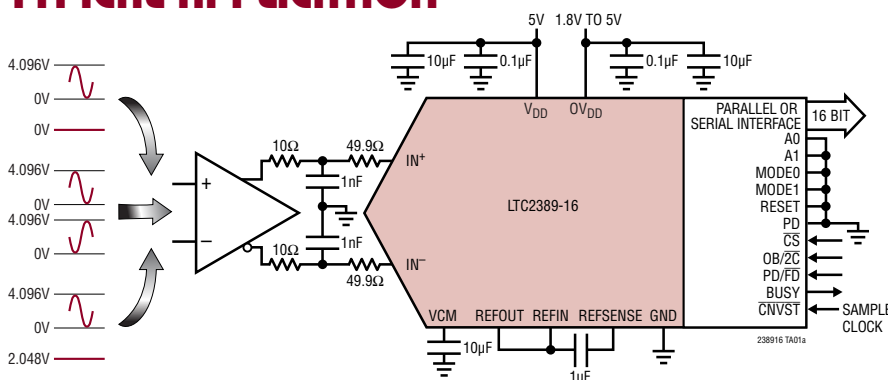

32k Point FFT  $f_{SAMPL} = 2.5$ Msps,  $f_{IN} = 2$ kHz

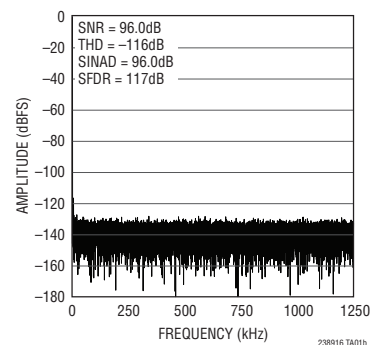

# LTC2389-16

## ABSOLUTE MAXIMUM RATINGS (Notes 1, 2)

Supply Voltage ( $V_{DD}$ , $OV_{DD}$ )	6V
Analog Input Voltage (Note 3)	
$IN^+$ , $IN^-$ , REFIN, $\overline{CNVST}$	(GND – 0.3V) to ( $V_{DD}$ + 0.3V)
Digital Input Voltage (Note 3)	(GND – 0.3V) to ( $OV_{DD}$ + 0.3V)
Digital Output Voltage (Note 3)	(GND – 0.3V) to ( $OV_{DD}$ + 0.3V)
Power Dissipation	500mW

Operating Temperature Range	
LTC2389C	0°C to 70°C
LTC2389I	–40°C to 85°C
LTC2389H	–40°C to 125°C
Storage Temperature Range	–65°C to 150°C
Lead Temperature (Soldering, 10 sec)	
LX Package	300°C

## PIN CONFIGURATION

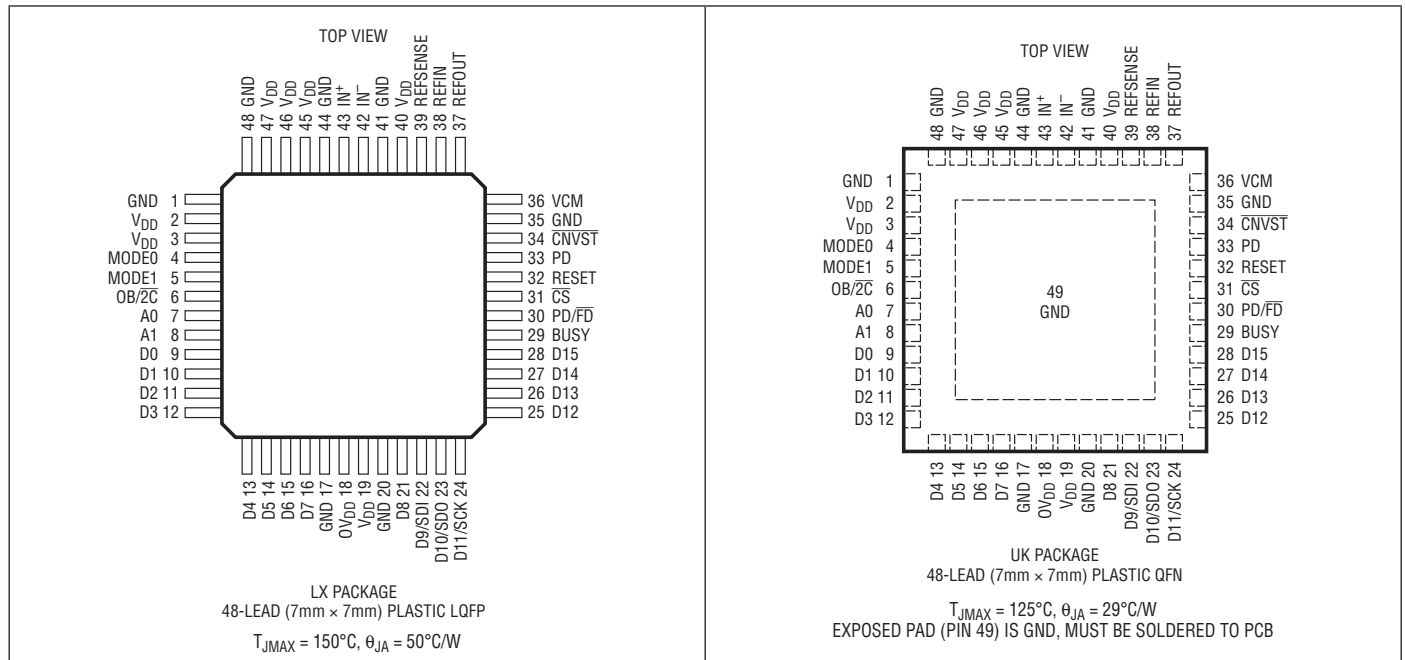

## ORDER INFORMATION

LEAD FREE FINISH	TAPE AND REEL	PART MARKING*	PACKAGE DESCRIPTION	TEMPERATURE RANGE
LTC2389CUK-16#PBF	LTC2389CUK-16#TRPBF	LTC2389UK-16	48-Lead 7mm × 7mm Plastic QFN	0°C to 70°C
LTC2389IUK-16#PBF	LTC2389IUK-16#TRPBF	LTC2389UK-16	48-Lead 7mm × 7mm Plastic QFN	–40°C to 85°C
LEAD FREE FINISH	TRAY	PART MARKING*	PACKAGE DESCRIPTION	TEMPERATURE RANGE
LTC2389CLX-16#PBF	LTC2389CLX-16#PBF	LTC2389LX-16	48-Lead 7mm × 7mm Plastic LQFP	0°C to 70°C
LTC2389ILX-16#PBF	LTC2389ILX-16#PBF	LTC2389LX-16	48-Lead 7mm × 7mm Plastic LQFP	–40°C to 85°C
LTC2389HLX-16#PBF	LTC2389HLX-16#PBF	LTC2389LX-16	48-Lead 7mm × 7mm Plastic LQFP	–40°C to 125°C

Consult LTC Marketing for parts specified with wider operating temperature ranges. \*The temperature grade is identified by a label on the shipping container. Consult LTC Marketing for information on non-standard lead based finish parts.

For more information on lead free part marking, go to: <http://www.linear.com/leadfree/>

For more information on tape and reel specifications, go to: <http://www.linear.com/tapeandree/>

## ANALOG INPUT

The ● denotes the specifications which apply over the full operating temperature range, otherwise specifications are at  $T_A = 25^\circ\text{C}$ . (Note 4)

SYMBOL	PARAMETER	CONDITIONS		MIN	TYP	MAX	UNITS
$V_{IN+}$	Absolute Input Range ( $IN^+$ )	(Note 5)	●	-0.1		$V_{REF} + 0.1$	V
$V_{IN-}$	Absolute Input Range ( $IN^-$ )	Fully Differential (Note 5)	●	-0.1		$V_{REF} + 0.1$	V
		Pseudo-Differential Unipolar (Note 5)	●	-0.1	0	0.1	V
		Pseudo-Differential Bipolar (Note 5)	●	$V_{REF}/2 - 0.1$	$V_{REF}/2$	$V_{REF}/2 + 0.1$	V
$V_{IN+} - V_{IN-}$	Input Differential Voltage Range	Fully Differential	●	$-V_{REF}$		$V_{REF}$	V
		Pseudo-Differential Unipolar	●	0		$V_{REF}$	V
		Pseudo-Differential Bipolar	●	$-V_{REF}/2$		$V_{REF}/2$	V
$V_{CM}$	Input Common Mode Voltage Range	Fully Differential	●	$V_{REF}/2 - 0.1$	$V_{REF}/2$	$V_{REF}/2 + 0.1$	V
$I_{IN}$	Analog Input Leakage Current	C- and I-Grades	●	-1		1	$\mu\text{A}$
		H-Grade	●	-2		2	$\mu\text{A}$
$C_{IN}$	Analog Input Capacitance	Sample Mode			45		pF
		Hold Mode			5		pF
CMRR	Input Common Mode Rejection Ratio				70		dB
$V_{IHCNVST}$	CNVST High Level Input Voltage		●	1.5			V
$V_{ILCNVST}$	CNVST Low Level Input Voltage		●			0.5	V
$I_{INCNVST}$	CNVST Input Current	$V_{IN} = 0\text{V to }V_{DD}$	●		-25	-60	$\mu\text{A}$

## CONVERTER CHARACTERISTICS

The ● denotes the specifications which apply over the full operating temperature range, otherwise specifications are at  $T_A = 25^\circ\text{C}$ . (Note 4)

SYMBOL	PARAMETER	CONDITIONS		MIN	TYP	MAX	UNITS
	Resolution		●	16			Bits
	No Missing Codes		●	16			Bits
	Transition Noise	Fully Differential			0.19		$\text{LSB}_{RMS}$
		Pseudo-Differential Unipolar			0.38		$\text{LSB}_{RMS}$
		Pseudo-Differential Bipolar			0.38		$\text{LSB}_{RMS}$
INL	Integral Linearity Error	Fully Differential (Note 6)	●	-1	$\pm 0.3$	1	LSB
		Pseudo-Differential Unipolar (Note 6)	●	-1	$\pm 0.3$	1	LSB
		Pseudo-Differential Bipolar (Note 6)	●	-1	$\pm 0.3$	1	LSB
DNL	Differential Linearity Error	Fully Differential	●	-0.6	$\pm 0.1$	0.6	LSB
		Pseudo-Differential Unipolar	●	-0.7	$\pm 0.1$	0.7	LSB
		Pseudo-Differential Bipolar	●	-0.7	$\pm 0.1$	0.7	LSB
ZSE	Zero-Scale Error	Fully Differential (Note 7)	●	-3	0	3	LSB
		Pseudo-Differential Unipolar (Note 7)	●	-4	0	4	LSB
		Pseudo-Differential Bipolar (Note 7)	●	-4	0	4	LSB
	Zero-Scale Error Drift				$\pm 0.05$		ppm/ $^\circ\text{C}$
FSE	Full-Scale Error	External Reference (Note 7)	●			0.15	%
		Internal Reference (Note 7)				0.15	%
	Full-Scale Error Drift				$\pm 5$		ppm/ $^\circ\text{C}$

## DYNAMIC ACCURACY

The ● denotes the specifications which apply over the full operating temperature range, otherwise specifications are at  $T_A = 25^\circ\text{C}$ .  $A_{IN} = -1\text{dBFS}$  (Notes 4, 8)

SYMBOL	PARAMETER	CONDITIONS	MIN	TYP	MAX	UNITS	
SINAD	Signal-to-(Noise + Distortion) Ratio	Fully Differential, $f_{IN} = 2\text{kHz}$	●	94.4	96.0	dB	
		Pseudo-Differential Unipolar, $f_{IN} = 2\text{kHz}$	●	91.2	93.2	dB	
		Pseudo-Differential Bipolar, $f_{IN} = 2\text{kHz}$	●	91.7	93.5	dB	
		Fully Differential, $f_{IN} = 2\text{kHz}$ (H-Grade)	●	94.3	96.0	dB	
		Pseudo-Differential Unipolar, $f_{IN} = 2\text{kHz}$ (H-Grade)	●	91.0	93.2	dB	
		Pseudo-Differential Bipolar, $f_{IN} = 2\text{kHz}$ (H-Grade)	●	91.5	93.5	dB	
SNR	Signal-to-Noise Ratio	Fully Differential, $f_{IN} = 2\text{kHz}$	●	95.1	96.0	dB	
		Pseudo-Differential Unipolar, $f_{IN} = 2\text{kHz}$	●	91.7	93.2	dB	
		Pseudo-Differential Bipolar, $f_{IN} = 2\text{kHz}$	●	92.1	93.5	dB	
		Fully Differential, $f_{IN} = 2\text{kHz}$ (H-Grade)	●	94.9	96.0	dB	
		Pseudo-Differential Unipolar, $f_{IN} = 2\text{kHz}$ (H-Grade)	●	91.5	93.2	dB	
		Pseudo-Differential Bipolar, $f_{IN} = 2\text{kHz}$ (H-Grade)	●	91.9	93.5	dB	
THD	Total Harmonic Distortion	Fully Differential, $f_{IN} = 2\text{kHz}$ , First 5 Harmonics	●		-116	-103	dB
		Pseudo-Differential Unipolar, $f_{IN} = 2\text{kHz}$ , First 5 Harmonics	●		-112	-101	dB
		Pseudo-Differential Bipolar, $f_{IN} = 2\text{kHz}$ , First 5 Harmonics	●		-111	-102	dB
		Fully Differential, $f_{IN} = 2\text{kHz}$ , First 5 Harmonics (H-Grade)	●		-116	-103	dB
		Pseudo-Differential Unipolar, $f_{IN} = 2\text{kHz}$ , First 5 Harmonics (H-Grade)	●		-112	-101	dB
		Pseudo-Differential Bipolar, $f_{IN} = 2\text{kHz}$ , First 5 Harmonics (H-Grade)	●		-111	-102	dB
SFDR	Spurious-Free Dynamic Range	Fully Differential, $f_{IN} = 2\text{kHz}$	●	104	117	dB	
		Pseudo-Differential Unipolar, $f_{IN} = 2\text{kHz}$	●	102	113	dB	
		Pseudo-Differential Bipolar, $f_{IN} = 2\text{kHz}$	●	102	112	dB	
		Fully Differential, $f_{IN} = 2\text{kHz}$ (H-Grade)	●	103	117	dB	
		Pseudo-Differential Unipolar, $f_{IN} = 2\text{kHz}$ (H-Grade)	●	102	113	dB	
		Pseudo-Differential Bipolar, $f_{IN} = 2\text{kHz}$ (H-Grade)	●	102	112	dB	
	-3dB Input Bandwidth			50		MHz	
	Aperture Delay			0.5		ns	
	Aperture Jitter			1		ps <sub>RMS</sub>	
	Transient Response	Full-Scale Step		70		ns	

## REFERENCE CHARACTERISTICS

The ● denotes the specifications which apply over the full operating temperature range, otherwise specifications are at  $T_A = 25^\circ\text{C}$ . (Note 4)

SYMBOL	PARAMETER	CONDITIONS	MIN	TYP	MAX	UNITS	
$V_{\text{REFOUT}}$	Internal Reference Voltage	REFOUT Tied to REFIN, $I_{\text{OUT}} = 0\mu\text{A}$		4.076	4.096	4.116	V
	$V_{\text{REFOUT}}$ Tempco	$I_{\text{OUT}} = 0\mu\text{A}$ (Note 9)	●		±10	±20	ppm/°C
	REFOUT Output Impedance	$-0.1\text{mA} \leq I_{\text{OUT}} \leq 0.1\text{mA}$			2.3		kΩ
	REFOUT Line Regulation	$V_{\text{DD}} = 4.75\text{V}$ to $5.25\text{V}$			0.3		mV/V
$V_{\text{REF}}$	Converter REFIN Voltage		4.076	4.096	4.116	V	
	REFIN Input Impedance			74		kΩ	
	VCM Output Voltage	$I_{\text{OUT}} = 0\mu\text{A}$		2.08		V	

## DIGITAL INPUTS AND DIGITAL OUTPUTS

The ● denotes the specifications which apply over the full operating temperature range, otherwise specifications are at  $T_A = 25^\circ\text{C}$ . (Note 4)

SYMBOL	PARAMETER	CONDITIONS	MIN	TYP	MAX	UNITS
$V_{IH}$	High Level Input Voltage		● $0.8 \cdot OV_{DD}$			V
$V_{IL}$	Low Level Input Voltage		●		$0.2 \cdot OV_{DD}$	V
$I_{IN}$	Digital Input Current	$V_{IN} = 0V$ to $OV_{DD}$	● -10		10	$\mu\text{A}$
$C_{IN}$	Digital Input Capacitance			5		pF
$V_{OH}$	High Level Output Voltage	$I_{OUT} = -500\mu\text{A}$	● $OV_{DD} - 0.2$			V
$V_{OL}$	Low Level Output Voltage	$I_{OUT} = 500\mu\text{A}$	●		0.2	V
$I_{OZ}$	Hi-Z Output Leakage Current	$V_{OUT} = 0V$ to $OV_{DD}$	● -10		10	$\mu\text{A}$
$I_{SOURCE}$	Output Source Current	$V_{OUT} = 0V$		-10		mA
$I_{SINK}$	Output Sink Current	$V_{OUT} = OV_{DD}$		10		mA

## POWER REQUIREMENTS

The ● denotes the specifications which apply over the full operating temperature range, otherwise specifications are at  $T_A = 25^\circ\text{C}$ . (Note 4)

SYMBOL	PARAMETER	CONDITIONS	MIN	TYP	MAX	UNITS
$V_{DD}$	Supply Voltage		● 4.75	5	5.25	V
$OV_{DD}$	Supply Voltage		● 1.71		5.25	V
$I_{VDD}$	Core Supply Current	2.5Msps Sample Rate 2.5Msps Sample Rate, Internal Reference Enabled	●	32.5 34.1	36	mA mA
$I_{OVDD}$	I/O Supply Current	2.5Msps Sample Rate ( $C_L = 15\text{pF}$ )		1.6		mA
$I_{PD}$	Power Down Current ( $I_{VDD} + I_{OVDD}$ )	Conversion Done, $P_D = OV_{DD}$ , Other Digital Inputs Tied to $OV_{DD}$ or GND	●	15	250	$\mu\text{A}$
$P_D$	Power Dissipation	2.5Msps Sample Rate Conversion Done, $P_D = OV_{DD}$ , Other Digital Inputs Tied to $OV_{DD}$ or GND		162.5 75	180 1250	mW $\mu\text{W}$

## TIMING CHARACTERISTICS

The ● denotes the specifications which apply over the full operating temperature range, otherwise specifications are at  $T_A = 25^\circ\text{C}$ . (Note 4)

SYMBOL	PARAMETER	CONDITIONS	MIN	TYP	MAX	UNITS
$f_{SMPL}$	Sampling Frequency	Parallel Output Modes Serial Output Mode	●		2.5 2.0	Msps Msps
$t_{CONV}$	Conversion Time		● 245	280	310	ns
$t_{ACQ}$	Acquisition Time	$t_{ACQ} = t_{CYC} - t_{CONV} - t_{BUSYLH}$ (Note 10)	● 77	110		ns
$t_{CYC}$	Time Between $\overline{CNVST}\downarrow$		● 400			ns
$t_{CNVSTL}$	$\overline{CNVST}$ Low Time		● 20			ns
$t_{CNVSTH}$	$\overline{CNVST}$ High Time		● 200			ns
$t_{BUSYLH}$	$\overline{CNVST}\downarrow$ to BUSY Delay	$C_L = 15\text{pF}$	●		13	ns
$t_{RESETH}$	RESET Pulse Width		● 200			ns
$t_{SCK}$	SCK Period	(Notes 5, 11)	● 10			ns
$t_{SCKH}$	SCK High Time		● 4			ns
$t_{SCKL}$	SCK Low Time		● 4			ns
$t_{DSCK}$	SCK $\downarrow$ Delay From $\overline{CS}\downarrow$		● 10			ns
$t_{SSDI}$	SDI Setup Time From SCK $\downarrow$		● 2			ns

## TIMING CHARACTERISTICS

The ● denotes the specifications which apply over the full operating temperature range, otherwise specifications are at  $T_A = 25^\circ\text{C}$ . (Note 4)

$t_{\text{HSDI}}$	SDI Hold Time From SCK↓		●	1	ns
$t_{\text{DSDO}}$	SDO Data Valid Delay From SCK↑	$C_L = 15\text{pF}$	●	9	ns
$t_{\text{HSDO}}$	SDO Data Remains Valid Delay From SCK↑	$C_L = 15\text{pF}$	●	1	ns
$t_{\text{DDBUSYL}}$	Data Valid to BUSY↓	$C_L = 15\text{pF}$	●	1	ns
$t_{\text{EN}}$	Bus Enable Time After $\overline{\text{CS}}\downarrow$		●	11	ns
$t_{\text{DDA1}}$	Data Valid Delay From A1 Transition	$C_L = 15\text{pF}$	●	8	ns
$t_{\text{DIS}}$	Bus Relinquish Time After $\overline{\text{CS}}\uparrow$		●	11	ns

**Note 1:** Stresses beyond those listed under Absolute Maximum Ratings may cause permanent damage to the device. Exposure to any Absolute Maximum Rating condition for extended periods may affect device reliability and lifetime.

**Note 2:** All voltage values are with respect to ground.

**Note 3:** When these pin voltages are taken below ground or above  $V_{\text{DD}}$  or  $OV_{\text{DD}}$ , they will be clamped by internal diodes. This product can handle input currents up to 100mA below ground, or above  $V_{\text{DD}}$  or  $OV_{\text{DD}}$ , without latchup.

**Note 4:**  $V_{\text{DD}} = 5\text{V}$ ,  $OV_{\text{DD}} = 5\text{V}$ ,  $V_{\text{REF}} = 4.096\text{V}$  external reference,  $f_{\text{SAMPL}} = 2.5\text{MHz}$ , unless otherwise noted.

**Note 5:** Recommended operating conditions.

**Note 6:** Integral nonlinearity is defined as the deviation of a code from a straight line passing through the actual endpoints of the transfer curve. The deviation is measured from the center of the quantization band.

**Note 7:** Fully differential zero-scale error is the offset voltage measured from  $-0.5\text{LSB}$  when the output code flickers between 0000 0000 0000 0000 and 1111 1111 1111 1111 in two's complement format. Unipolar

zero-scale error is the offset voltage measured from  $0.5\text{LSB}$  when the output code flickers between 0000 0000 0000 0000 and 0000 0000 0000 0001. Bipolar zero-scale error is the offset voltage measured from  $-0.5\text{LSB}$  when the output code flickers between 0000 0000 0000 0000 and 1111 1111 1111 1111. Fully differential full-scale error is the worst-case deviation of the first and last code transitions from ideal and includes the effect of offset error. Unipolar full-scale error is the deviation of the last code transition from ideal and includes the effect of offset error. Bipolar full-scale error is the worst-case deviation of the first and last code transitions from ideal and includes the effect of offset error.

**Note 8:** All specifications in dB are referred to a full-scale  $\pm 4.096\text{V}$  (fully differential),  $0\text{V}$  to  $4.096\text{V}$  (pseudo-differential unipolar), or  $\pm 2.048\text{V}$  (pseudo-differential bipolar) input with a  $4.096\text{V}$  reference voltage.

**Note 9:** Temperature coefficient is calculated by dividing the maximum change in output voltage by the specified temperature range.

**Note 10:** Guaranteed by design, not subject to test.

**Note 11:** A  $t_{\text{SCK}}$  period of 10ns minimum allows a shift clock frequency of up to 100MHz for rising capture.

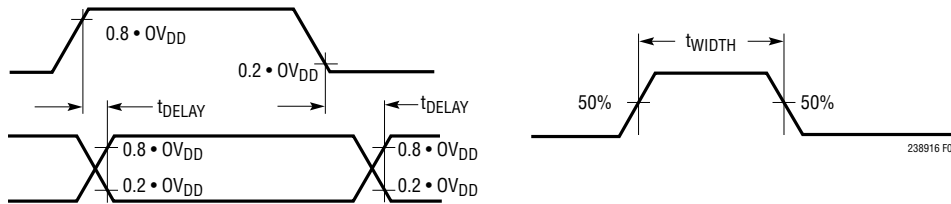
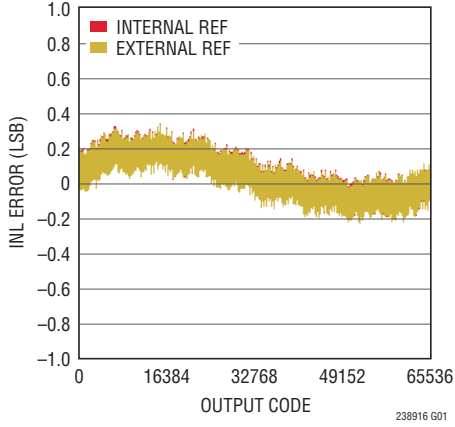

Figure 1. Voltage Levels for Timing Specifications

**TYPICAL PERFORMANCE CHARACTERISTICS**  $T_A = 25^\circ\text{C}$ ,  $V_{DD} = 5\text{V}$ ,  $0V_{DD} = 2.5\text{V}$ ,  $V_{REF} = 4.096\text{V}$   
 External Reference, Fully Differential Range (PD/FD = 0V),  $V_{CM} = 2.048\text{V}$ ,  $f_{SMPL} = 2.5\text{Mpsps}$ , unless otherwise noted.

**Integral Nonlinearity vs Output Code**



**Differential Nonlinearity vs Output Code**

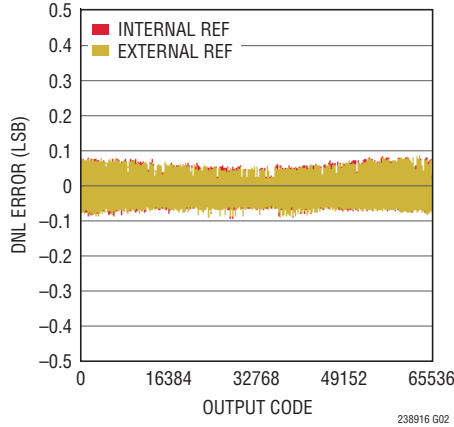

**DC Histogram (Zero-Scale)**

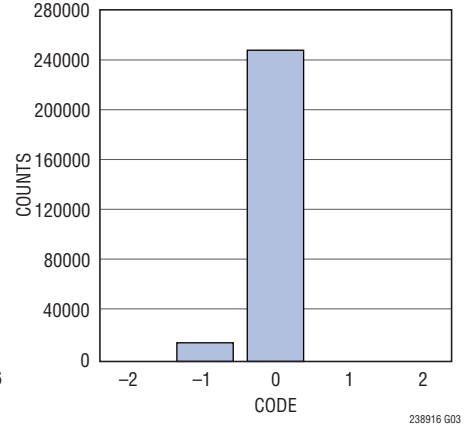

**DC Histogram (Near Full-Scale)**

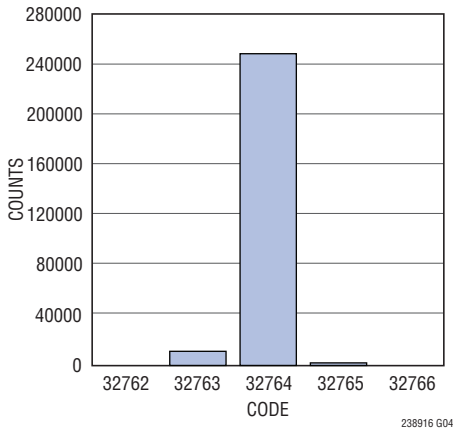

**Internal Reference Output vs Temperature**

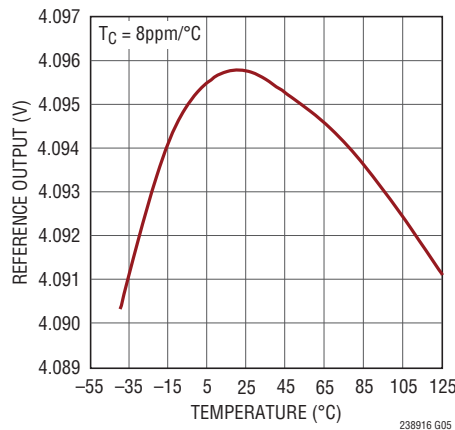

**32k Point FFT  $f_{SMPL} = 2.5\text{Mpsps}$ ,  $f_{IN} = 2\text{kHz}$**

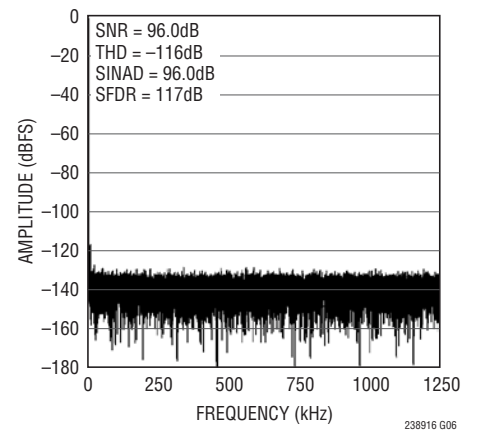

**SNR, SINAD vs Input Frequency**

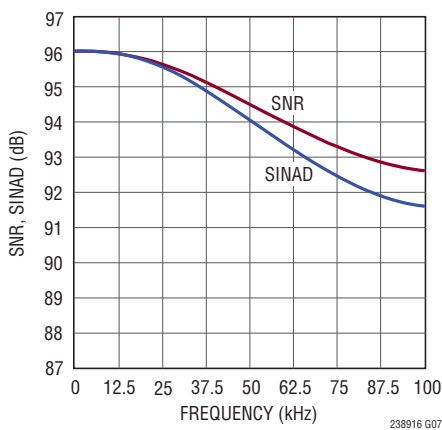

**THD, Harmonics vs Input Frequency**

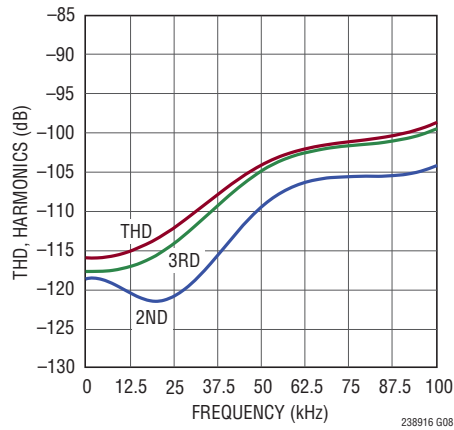

**SNR, SINAD vs Input Level,  $f_{IN} = 2\text{kHz}$**

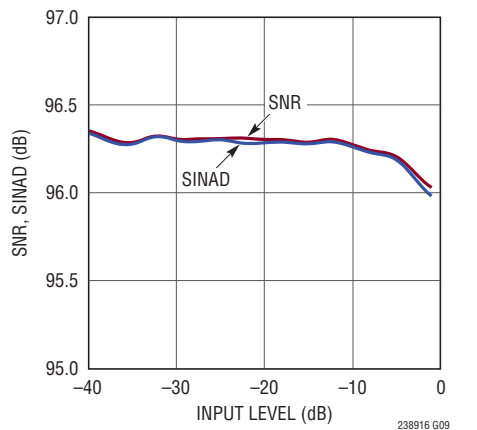

## TYPICAL PERFORMANCE CHARACTERISTICS

$T_A = 25^\circ\text{C}$ ,  $V_{DD} = 5\text{V}$ ,  $OV_{DD} = 2.5\text{V}$ ,  $V_{REF} = 4.096\text{V}$   
 External Reference, Fully Differential Range (PD/FD = 0V),  $V_{CM} = 2.048\text{V}$ ,  $f_{SAMPL} = 2.5\text{Msps}$ , unless otherwise noted.

**SNR, SINAD vs Temperature,**  
 $f_{IN} = 2\text{kHz}$

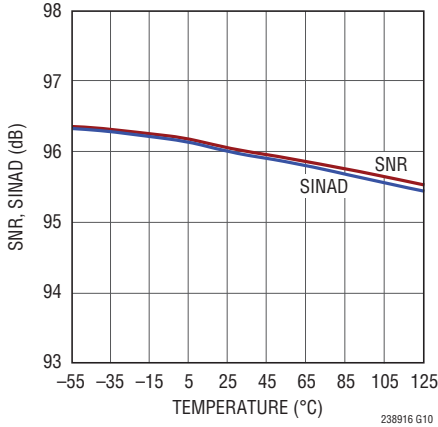

**THD, Harmonics vs Temperature,**  
 $f_{IN} = 2\text{kHz}$

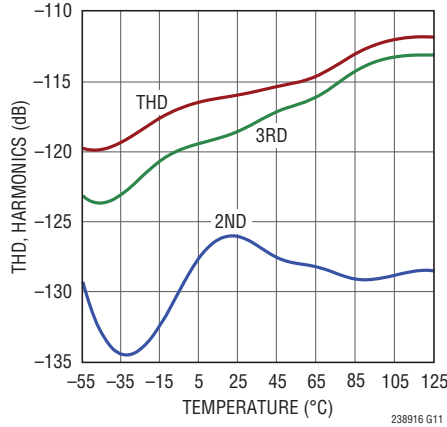

**INL/DNL vs Temperature**

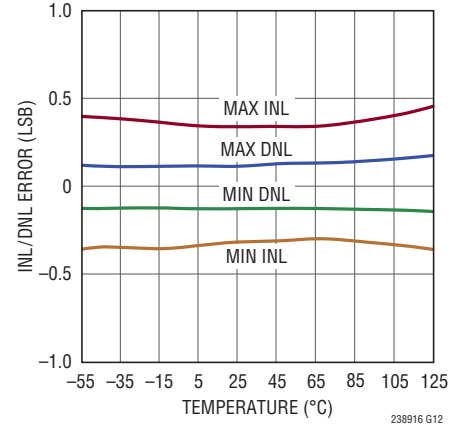

**Offset Error vs Temperature**

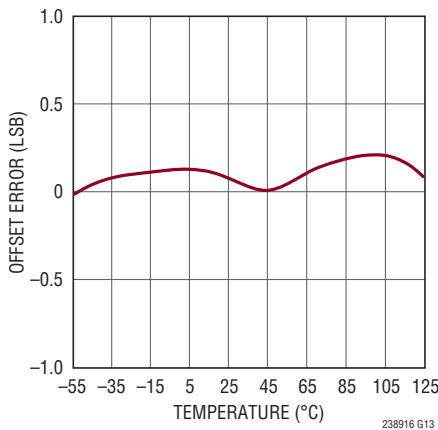

**Full-Scale Error vs Temperature**

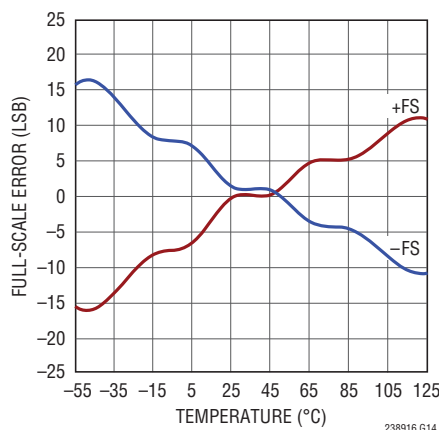

**Supply Current vs Temperature**

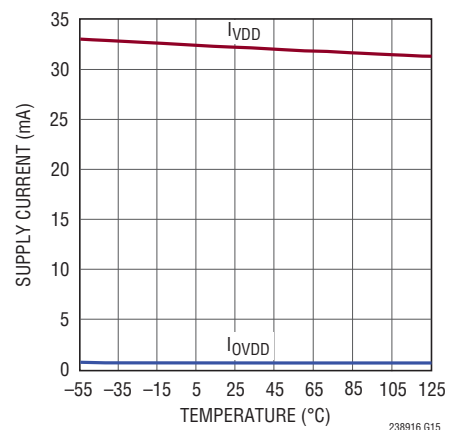

**Power-Down Current vs Temperature**

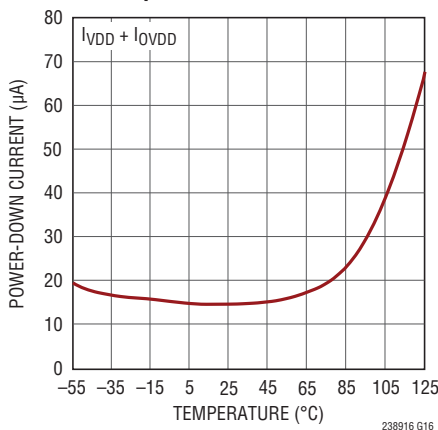

**Supply Current vs Sampling Frequency**

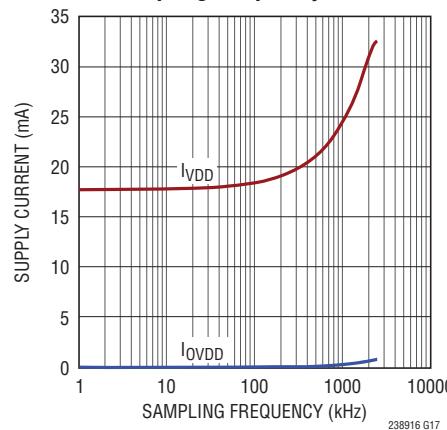

**CMRR vs Input Frequency**

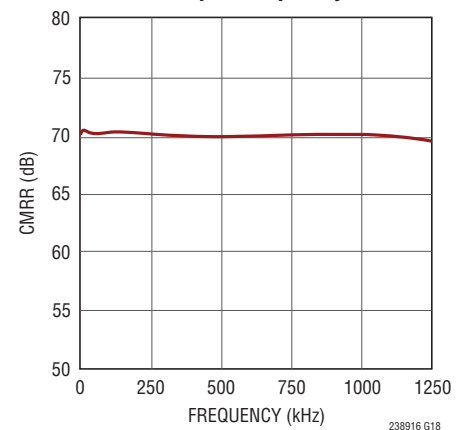



**TYPICAL PERFORMANCE CHARACTERISTICS**  $T_A = 25^\circ\text{C}$ ,  $V_{DD} = 5\text{V}$ ,  $0V_{DD} = 2.5\text{V}$ ,  $V_{REF} = 4.096\text{V}$   
 External Reference, Pseudo-Differential Unipolar Range ( $PD/\overline{FD} = 0V_{DD}$ ,  $OB/2\overline{C} = 0V_{DD}$ ),  $f_{SAMPL} = 2.5\text{Mpsps}$ , unless otherwise noted.

**Integral Nonlinearity vs Output Code**

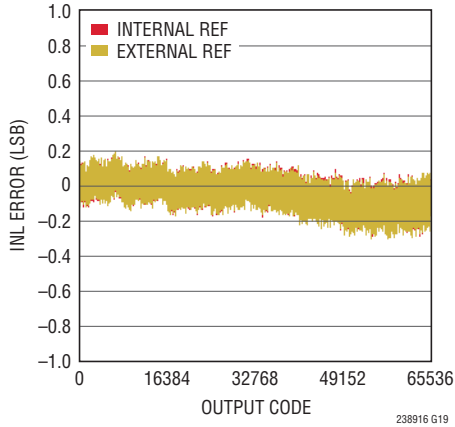

**Differential Nonlinearity vs Output Code**

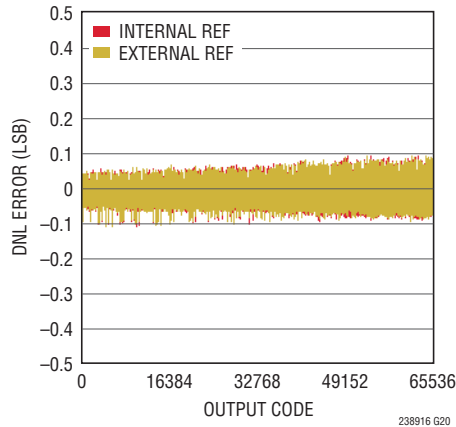

**DC Histogram (Near Zero-Scale)**

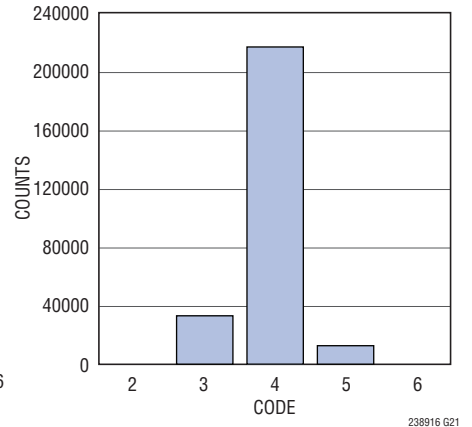

**DC Histogram (Near Full-Scale)**

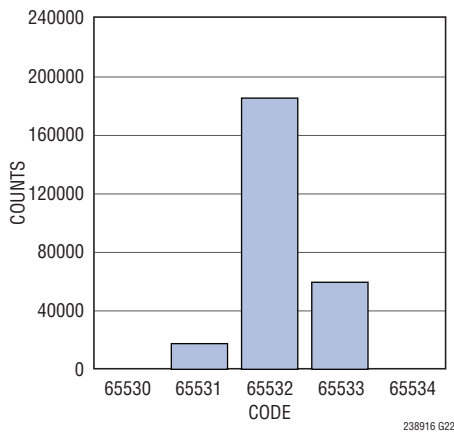

**32k Point FFT  $f_{SAMPL} = 2.5\text{Mpsps}$ ,  $f_{IN} = 2\text{kHz}$**

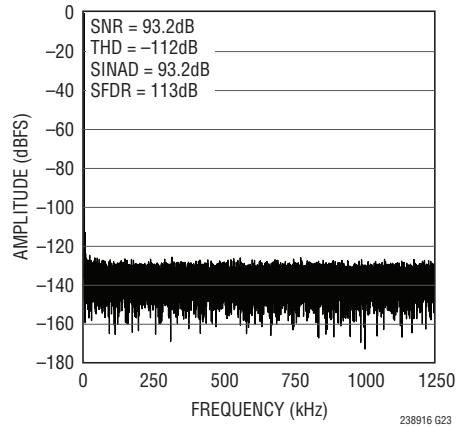

**SNR, SINAD vs Input Frequency**

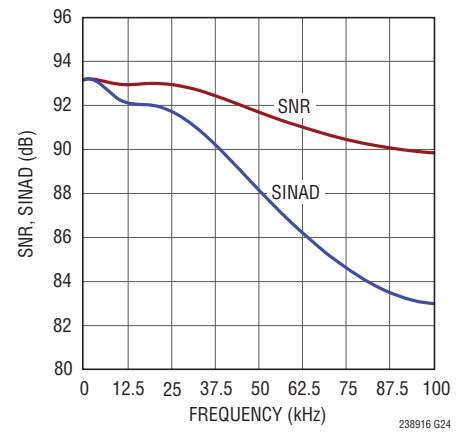

**THD, Harmonics vs Input Frequency**

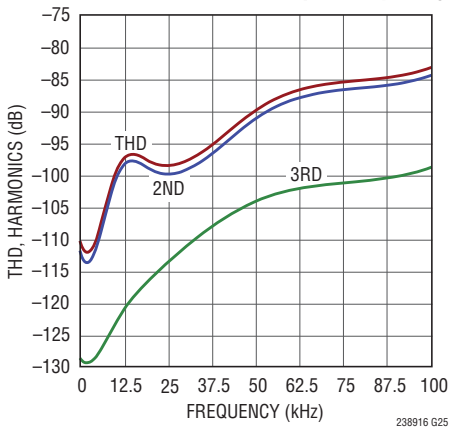

**SNR, SINAD vs Input Level,  $f_{IN} = 2\text{kHz}$**

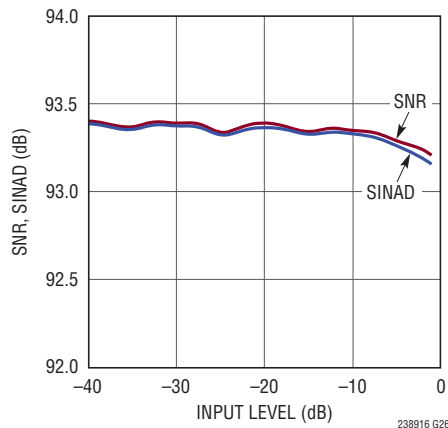

**SNR, SINAD vs Temperature,  $f_{IN} = 2\text{kHz}$**

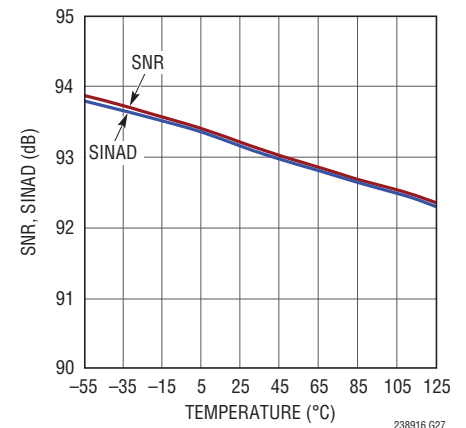

## TYPICAL PERFORMANCE CHARACTERISTICS $T_A = 25^\circ\text{C}$ , $V_{DD} = 5\text{V}$ , $0V_{DD} = 2.5\text{V}$ , $V_{REF} = 4.096\text{V}$ External Reference, Pseudo-Differential Unipolar Range ( $PD/\overline{FD} = 0V_{DD}$ , $OB/2\overline{C} = 0V_{DD}$ ), $f_{SAMPL} = 2.5\text{Mpsps}$ , unless otherwise noted.

**THD, Harmonics vs Temperature,**  
 $f_{IN} = 2\text{kHz}$

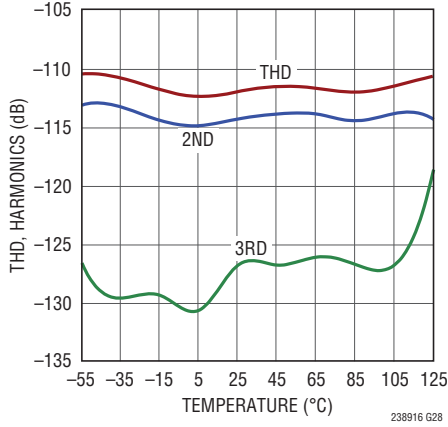

**INL/DNL vs Temperature**

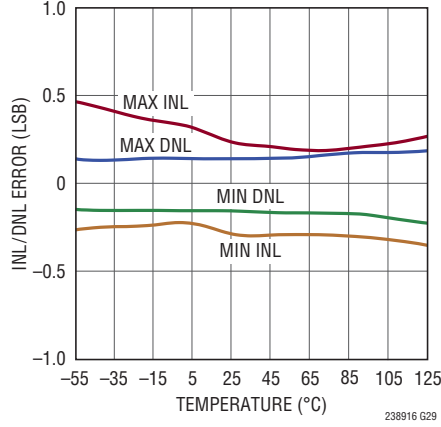

**Offset Error vs Temperature**

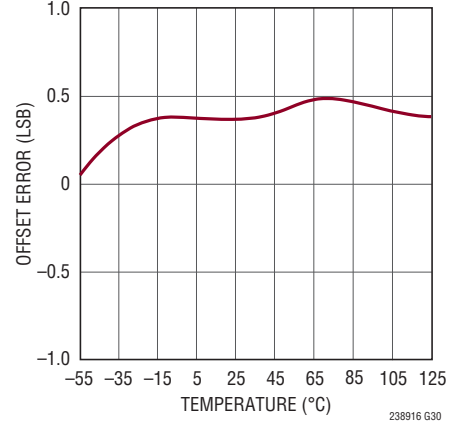

**Full-Scale Error vs Temperature**

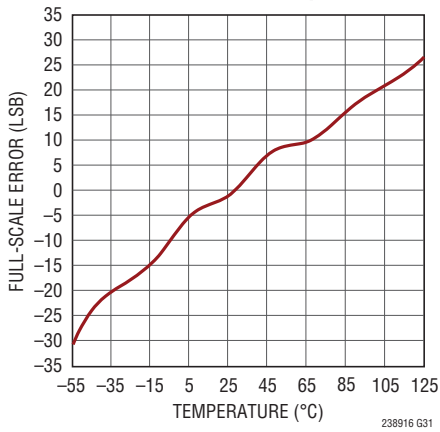

**CMRR vs Input Frequency**

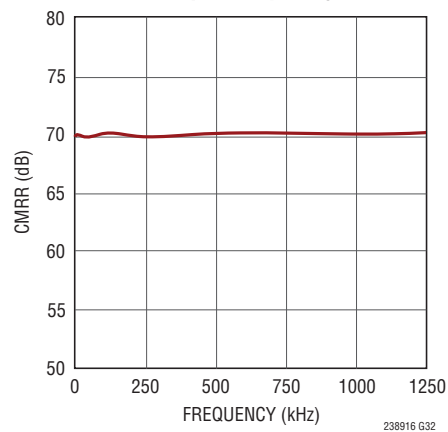

**TYPICAL PERFORMANCE CHARACTERISTICS**  $T_A = 25^\circ\text{C}$ ,  $V_{DD} = 5\text{V}$ ,  $0V_{DD} = 2.5\text{V}$ ,  $V_{REF} = 4.096\text{V}$   
 External Reference, Pseudo-Differential Bipolar Range ( $PD/\overline{FD} = 0V_{DD}$ ,  $OB/2\overline{C} = 0V$ ),  $f_{SAMPL} = 2.5\text{Mpsps}$ , unless otherwise noted.

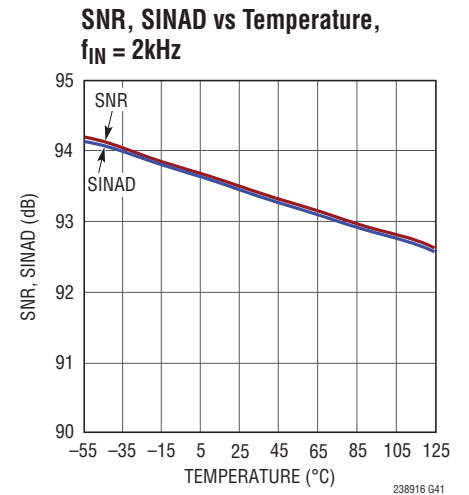
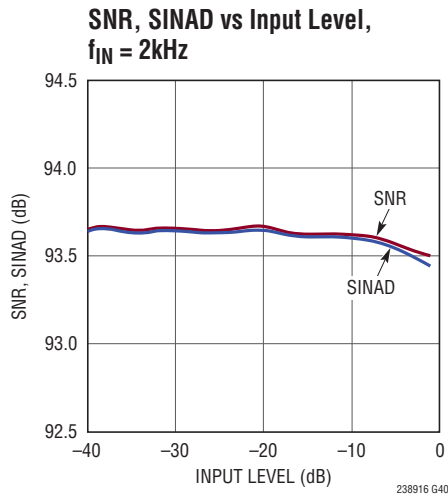
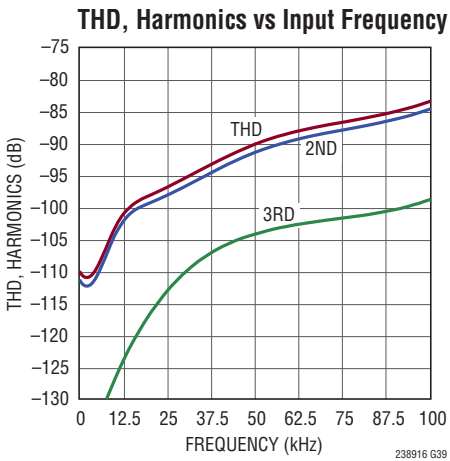
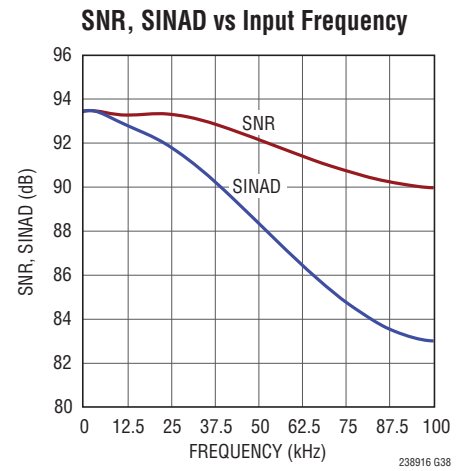
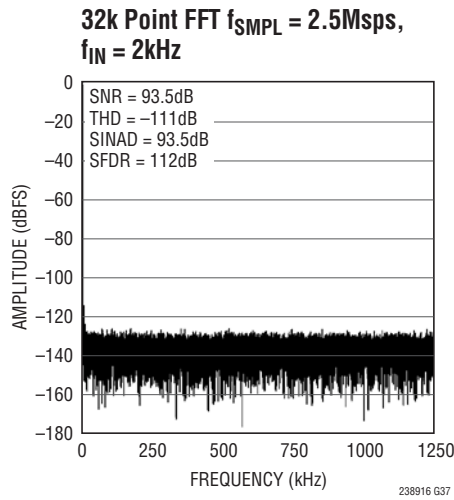
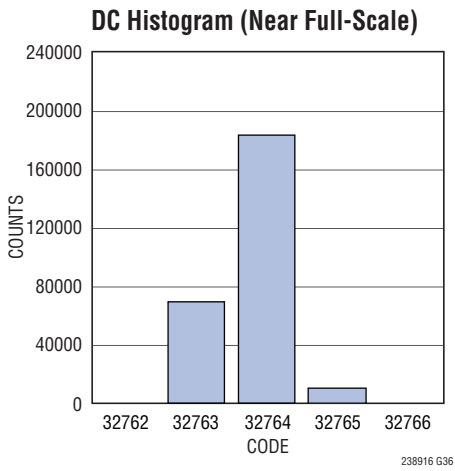
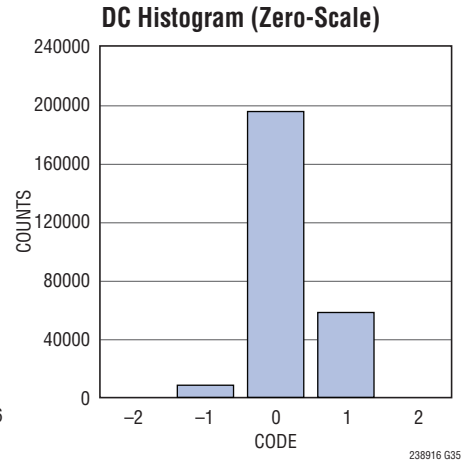
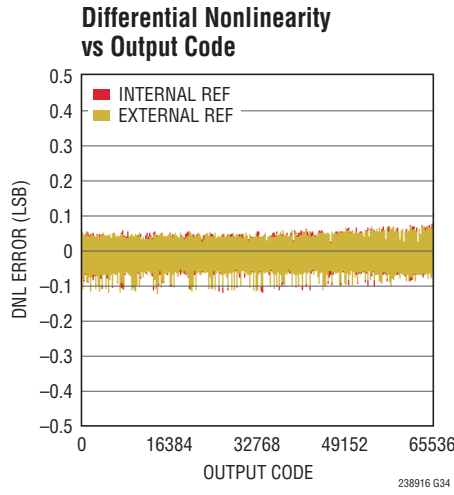
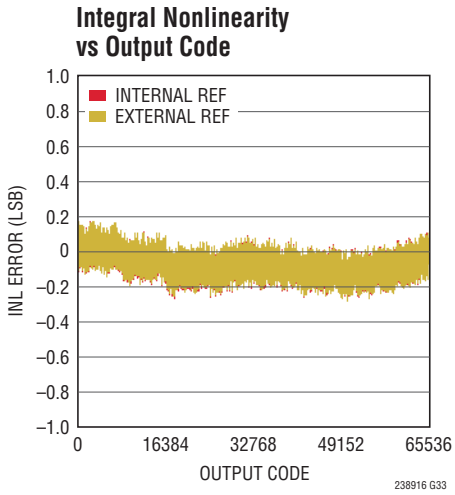

## TYPICAL PERFORMANCE CHARACTERISTICS $T_A = 25^\circ\text{C}$ , $V_{DD} = 5\text{V}$ , $0V_{DD} = 2.5\text{V}$ , $V_{REF} = 4.096\text{V}$ External Reference, Pseudo-Differential Bipolar Range ( $PD/\overline{FD} = 0V_{DD}$ , $OB/\overline{2C} = 0V$ ), $f_{SAMPL} = 2.5\text{MSPS}$ , unless otherwise noted.

**THD, Harmonics vs Temperature,**  
 $f_{IN} = 2\text{kHz}$

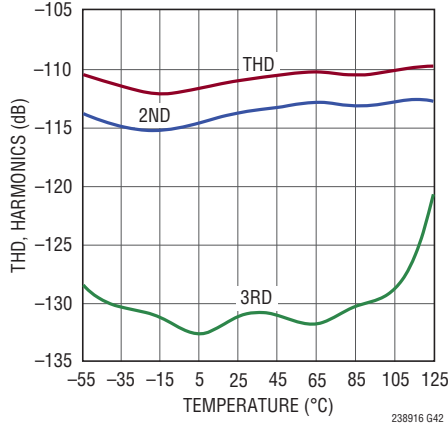

**INL/DNL vs Temperature**

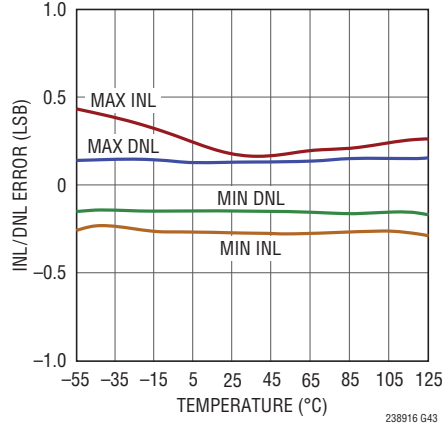

**Offset Error vs Temperature**

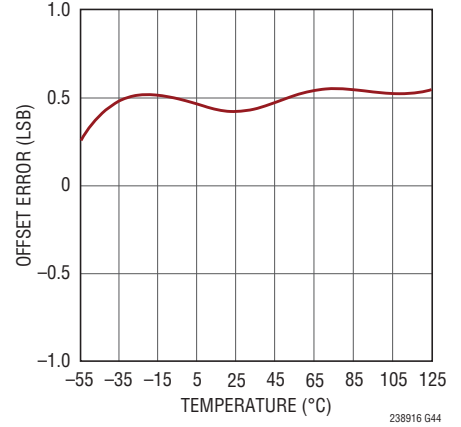

**Full-Scale Error vs Temperature**

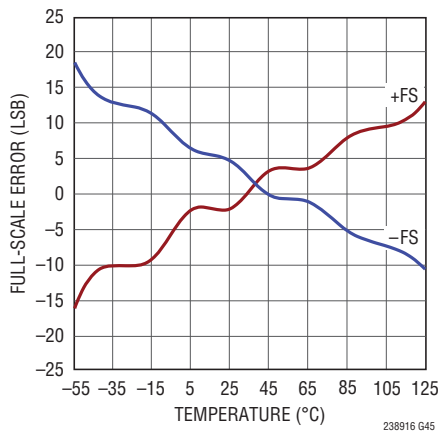

**CMRR vs Input Frequency**

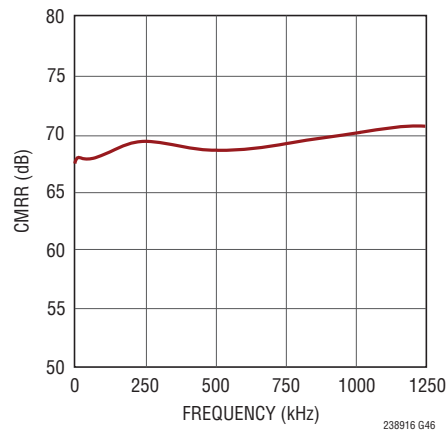

## PIN FUNCTIONS

**GND (Pins 1, 17, 20, 35, 41, 44, 48, Exposed Pad Pin 49 (QFN Only)):** Ground. Solder all GND pins and exposed pad to the ground plane.

**V<sub>DD</sub> (Pins 2, 3, 19, 40, 45, 46, 47):** 5V Power Supply. The range of V<sub>DD</sub> is 4.75V to 5.25V. Bypass V<sub>DD</sub> network to GND with a 0.1μF ceramic capacitor close to each pin and a 10μF ceramic capacitor in parallel.

**MODE0 (Pin 4):** Data Bus Configuration Input. This pin, in conjunction with Pin 8 (A1), controls the parsing and presentation of conversion results on the output data bus. Based on the state of MODE0, the bus is configured to provide either 16-bit/8-bit parallel (MODE0 = 0), or serial (MODE0 = 1) data, as described in Table 1. Digital outputs that are not active in a particular mode become Hi-Z. Logic levels are determined by OV<sub>DD</sub>. For information regarding pin compatibility with 18-bit versions of the LTC2389 family, refer to the Pin Compatibility with LTC2389-18 section.

**MODE1 (Pin 5):** Data Bus Configuration Input. This pin is reserved for use in 18-bit versions of the LTC2389 family, and for 16-bit versions of the family it should be driven to a logic low level. Logic levels are determined by OV<sub>DD</sub>. For information regarding pin compatibility with 18-bit versions of the LTC2389 family, refer to the Pin Compatibility with LTC2389-18 section.

**OB/ $\overline{2C}$  (Pin 6):** Offset Binary/Two's Complement Input. This pin, in conjunction with Pin 30 (PD/ $\overline{FD}$ ), controls the analog input range of the converter and the binary format of the conversion result, as described in Table 2. Logic levels are determined by OV<sub>DD</sub>.

**A0 (Pin 7):** Address Bit 0 Input. This pin is reserved for use in 18-bit versions of the LTC2389 family, and for 16-bit versions of the family it should be driven to a logic low level. Logic levels are determined by OV<sub>DD</sub>. For information regarding pin compatibility with 18-bit versions of the LTC2389 family, refer to the Pin Compatibility with LTC2389-18 section.

**A1 (Pin 8):** Address Bit 1 Input. This pin, in conjunction with Pin 4 (MODE0), controls the parsing and presentation of conversion results on the parallel output data bus. When MODE0 = 0, the bus is configured to provide 16-bit/8-bit parallel data, and the logic input A1 determines which segment of the conversion result is driven on the upper

and lower bytes of the bus, as described in Table 1. When MODE0 = 1, the output data bus is configured to provide serial data, and the logic input A1 has no effect on the parsing or presentation of the serial data. Logic levels are determined by OV<sub>DD</sub>. For information regarding pin compatibility with 18-bit versions of the LTC2389 family, refer to the Pin Compatibility with LTC2389-18 section.

**D0 (Pin 9):** Data Bit 0. When MODE0 = 0, this pin is bit 0 of the parallel data output bus, as described in Table 1. Logic levels are determined by OV<sub>DD</sub>.

**D1 (Pin 10):** Data Bit 1. When MODE0 = 0, this pin is bit 1 of the parallel data output bus, as described in Table 1. Logic levels are determined by OV<sub>DD</sub>.

**D2 (Pin 11):** Data Bit 2. When MODE0 = 0, this pin is bit 2 of the parallel data output bus, as described in Table 1. Logic levels are determined by OV<sub>DD</sub>.

**D3 (Pin 12):** Data Bit 3. When MODE0 = 0, this pin is bit 3 of the parallel data output bus, as described in Table 1. Logic levels are determined by OV<sub>DD</sub>.

**D4 (Pin 13):** Data Bit 4. When MODE0 = 0, this pin is bit 4 of the parallel data output bus, as described in Table 1. Logic levels are determined by OV<sub>DD</sub>.

**D5 (Pin 14):** Data Bit 5. When MODE0 = 0, this pin is bit 5 of the parallel data output bus, as described in Table 1. Logic levels are determined by OV<sub>DD</sub>.

**D6 (Pin 15):** Data Bit 6. When MODE0 = 0, this pin is bit 6 of the parallel data output bus, as described in Table 1. Logic levels are determined by OV<sub>DD</sub>.

**D7 (Pin 16):** Data Bit 7. When MODE0 = 0, this pin is bit 7 of the parallel data output bus, as described in Table 1. Logic levels are determined by OV<sub>DD</sub>.

**OV<sub>DD</sub> (Pin 18):** I/O Interface Power Supply. The range of OV<sub>DD</sub> is 1.71V to 5.25V. Bypass OV<sub>DD</sub> to GND close to the pin with a 0.1μF and a 10μF ceramic capacitor in parallel.

**D8 (Pin 21):** Data Bit 8. When MODE0 = 0, this pin is bit 8 of the parallel data output bus, as described in Table 1. Logic levels are determined by OV<sub>DD</sub>.

**D9/SDI (Pin 22):** Data Bit 9/Serial Data Input. When MODE0 = 0, this pin is bit 9 of the parallel data output bus, as described in Table 1. When MODE0 = 1, this pin

## PIN FUNCTIONS

is the serial data input, which can be used to daisy chain two or more converters on a single SDO line. The digital data level on SDI is output on SDO with a delay of 16 SCK periods after the start of the read sequence. Logic levels are determined by  $OV_{DD}$ .

**D10/SDO (Pin 23):** Data Bit 10/Serial Data Output. When  $MODE0 = 0$ , this pin is bit 10 of the parallel data output bus, as described in Table 1. When  $MODE0 = 1$ , this pin is the serial data output line, which serially outputs the result of the most recent conversion clocked by SCK. The data is output MSB first on the rising edge of SCK. The data format is determined by the logic levels of pins  $PD/\overline{FD}$  and  $OB/2C$ , as described in Table 2. Logic levels are determined by  $OV_{DD}$ .

**D11/SCK (Pin 24):** Data Bit 11/Serial Clock Input. When  $MODE0 = 0$ , this pin is bit 11 of the parallel data output bus, as described in Table 1. When  $MODE0 = 1$ , this pin this is the serial clock input. Logic levels are determined by  $OV_{DD}$ .

**D12 (Pin 25):** Data Bit 12. When  $MODE0 = 0$ , this pin is bit 12 of the parallel data output bus, as described in Table 1. Logic levels are determined by  $OV_{DD}$ .

**D13 (Pin 26):** Data Bit 13. When  $MODE0 = 0$ , this pin is bit 13 of the parallel data output bus, as described in Table 1. Logic levels are determined by  $OV_{DD}$ .

**D14 (Pin 27):** Data Bit 14. When  $MODE0 = 0$ , this pin is bit 14 of the parallel data output bus, as described in Table 1. Logic levels are determined by  $OV_{DD}$ .

**D15 (Pin 28):** Data Bit 15. When  $MODE0 = 0$ , this pin is bit 15 of the parallel data output bus, as described in Table 1. Logic levels are determined by  $OV_{DD}$ .

**BUSY (Pin 29):** Busy Output. This pin transitions low to high at the start of each conversion and stays high until the conversion is complete. The falling edge of BUSY can be used as the data-ready clock signal. Logic levels are determined by  $OV_{DD}$ .

**Table 1. Data Bus Configuration Table. Use Input  $MODE0$  to Select Bus Configuration Based on Application Bus Width. In the 16-Bit/8-Bit Parallel Configuration, Input A1 Controls Mapping of Upper and Lower Bytes of Conversion Result  $R[15:0]$  Onto Data Bus Pins  $D[15:0]$ . Shaded Cells Denote Bidirectional Pins Configured as Inputs.**

BUS CONFIGURATION	MODE0	A1	D[15:12]	D11	D10	D9	D8	D[7:0]
16-Bit/8-Bit Parallel	0	0		R[15:8]				R[7:0]
	0	1		R[7:0]				R[15:8]
Serial	1	X	All Hi-Z	SCK	SDO	SDI		All Hi-Z

## PIN FUNCTIONS

**PD/ $\overline{\text{FD}}$  (Pin 30):** Pseudo-Differential/Fully-Differential Input. This pin, in conjunction with Pin 6 (OB/ $\overline{2\text{C}}$ ), controls the analog input range of the converter and the binary format of the conversion result, as described in Table 2. Logic levels are determined by  $\text{OV}_{\text{DD}}$ .

**$\overline{\text{CS}}$  (Pin 31):** Chip Select Input. The data I/O bus is enabled when  $\overline{\text{CS}}$  is low and goes Hi-Z when  $\overline{\text{CS}}$  is high.  $\overline{\text{CS}}$  also gates the external shift clock. Logic levels are determined by  $\text{OV}_{\text{DD}}$ .

**RESET (Pin 32):** Reset Input. When this pin is brought high, the LTC2389-16 is reset. If this occurs during a conversion, the conversion is halted and the data bus becomes Hi-Z. Logic levels are determined by  $\text{OV}_{\text{DD}}$ .

**PD (Pin 33):** Power-Down Input. When this pin is brought high, the LTC2389-16 is powered down and subsequent conversion requests are ignored. Before enabling power-down, the result of the last conversion result should be read. Logic levels are determined by  $\text{OV}_{\text{DD}}$ .

**$\overline{\text{CNVST}}$  (Pin 34):** Conversion Start Input. A falling edge on this pin puts the internal sample-and-hold into the hold mode and starts a conversion.  $\overline{\text{CNVST}}$  is independent of  $\overline{\text{CS}}$ . Logic levels are determined by  $\text{V}_{\text{DD}}$ .

**VCM (Pin 36):** Common Mode Analog Output. Typically the output voltage on this pin is 2.08V. Bypass to GND with a 10 $\mu\text{F}$  capacitor.

**REFOUT (Pin 37):** Internal Reference Output. Connect this pin to REFIN if using the internal reference, giving a nominal reference voltage of 4.096V. If an external reference is used, connect REFOUT to ground to power down the internal reference.

**REFIN (Pin 38):** Reference Input. Connect this pin to REFOUT if using the internal reference, giving a nominal reference voltage of 4.096V. An external reference can be applied to REFIN if a more accurate reference is required. If an external reference is used tie REFOUT to ground to power down the internal reference. For increased filtering of reference noise, bypass this pin to REFSENSE using a 1 $\mu\text{F}$ , or larger, ceramic capacitor.

**REFSENSE (Pin 39):** Reference Input Sense. Do not connect REFSENSE to ground when using the internal reference. If an external reference is used, connect REFSENSE to the ground pin of the external reference.

**$\text{IN}^-$ ,  $\text{IN}^+$  (Pin 42, Pin 43):** Negative and Positive Analog Inputs. The analog input range depends on the levels applied to Pin 30 (PD/ $\overline{\text{FD}}$ ) and Pin 6 (OB/ $\overline{2\text{C}}$ ), as described in Table 2.

**Table 2. Analog Input Range and Output Binary Format Configuration Table. Use Inputs PD/ $\overline{\text{FD}}$  and OB/ $\overline{2\text{C}}$  to Select Converter Analog Input Range and Binary Format of Conversion Result.**

PD/ $\overline{\text{FD}}$	OB/ $\overline{2\text{C}}$	ANALOG INPUT RANGE	BINARY FORMAT OF CONVERSION RESULT
0	0	Fully-Differential	Two's Complement
0	1	Fully-Differential	Offset Binary
1	0	Pseudo-Differential Bipolar	Two's Complement
1	1	Pseudo-Differential Unipolar	Straight Binary

**FUNCTIONAL BLOCK DIAGRAM**

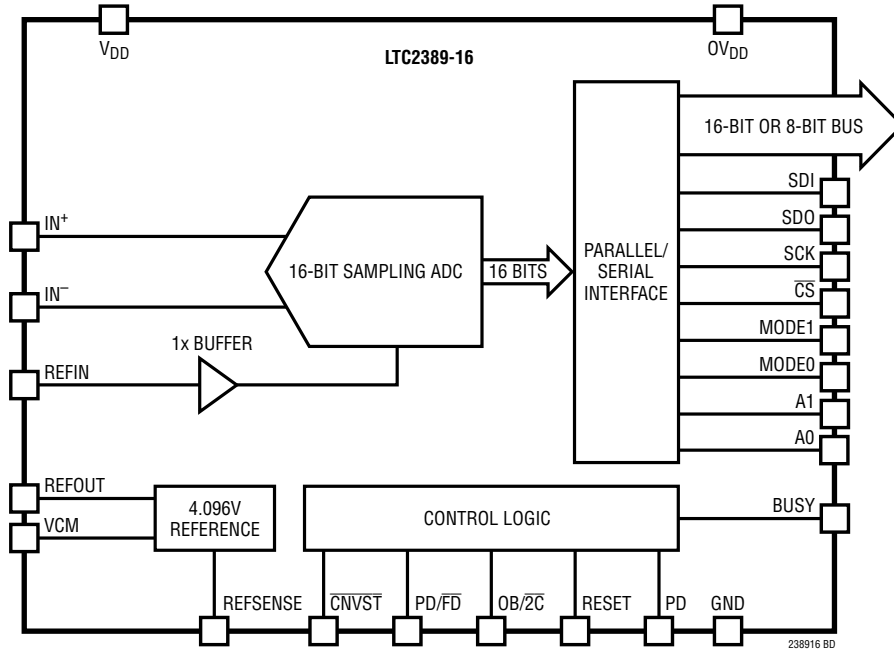

238916 BD



# TIMING DIAGRAMS

### Conversion Timing Using the Parallel Interface

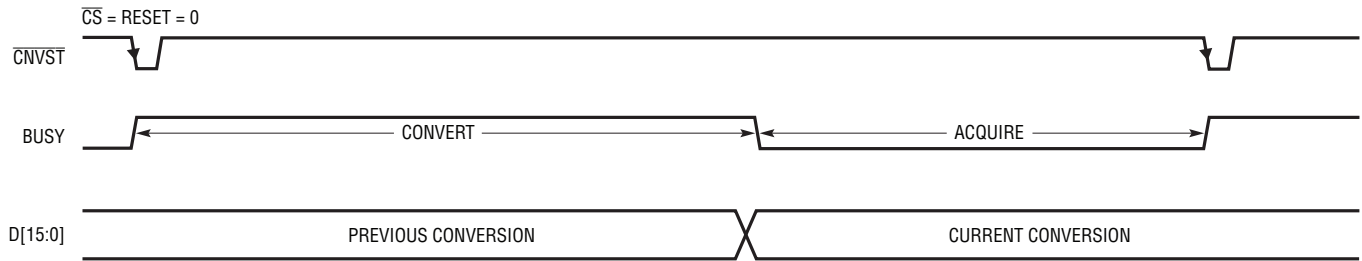

### Conversion Timing Using the Serial Interface

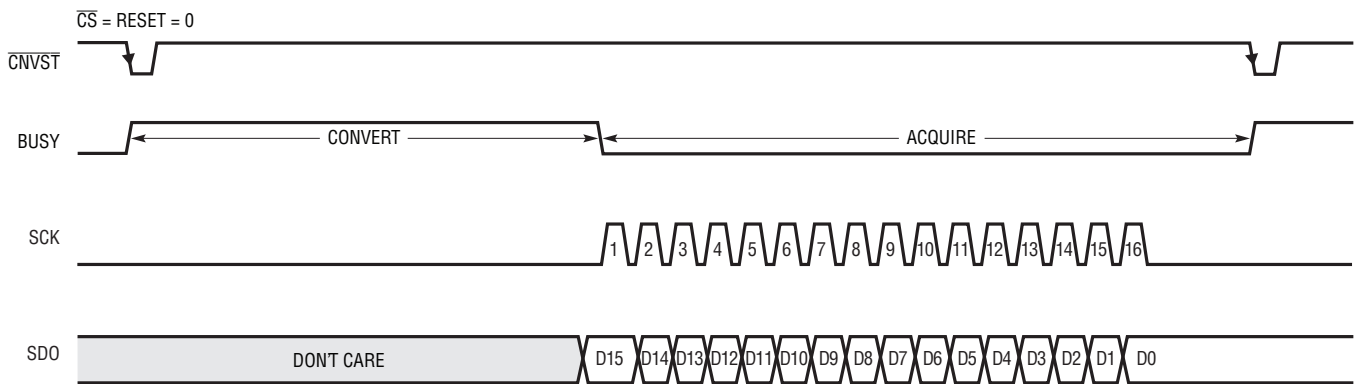

238916 TD01

## APPLICATIONS INFORMATION

### OVERVIEW

The LTC2389-16 is a low noise, high speed 16-bit successive approximation register (SAR) ADC. Operating from a single 5V supply, the LTC2389-16 supports pin-configurable fully differential ( $\pm 4.096\text{V}$ ), pseudo-differential unipolar (0V to 4.096V) and pseudo-differential bipolar ( $\pm 2.048\text{V}$ ) analog input ranges, allowing it to interface with multiple signal chain formats without requiring additional level translation or signal conditioning. The LTC2389-16 achieves  $\pm 1\text{LSB}$  INL (maximum), no missing codes at 16-bits, and 96.0dB (fully differential)/93.5dB (pseudo differential) SNR (typical).

The LTC2389-16 includes a precision internal 4.096V reference, with a guaranteed 0.5% initial accuracy and a  $\pm 20\text{ppm}/^\circ\text{C}$  (maximum) temperature coefficient, as well as an internal reference buffer. Fast 2.5MSPS throughput with no cycle latency in the parallel interface modes makes the LTC2389-16 ideally suited for a wide variety of high speed applications. An internal oscillator sets the conversion time, easing external timing considerations. The LTC2389-16 dissipates only 162.5mW at 2.5MSPS, while both nap and sleep power-down modes are provided to further reduce power consumption during inactive periods.

### CONVERTER OPERATION

The LTC2389-16 operates in two phases. During the acquisition phase, the charge redistribution capacitor D/A converter (CDAC) is connected to the  $\text{IN}^+$  and  $\text{IN}^-$  pins to sample the differential analog input voltage. A falling edge on the  $\overline{\text{CNVST}}$  pin initiates a conversion. During the conversion phase, the 16-bit CDAC is sequenced through a successive approximation algorithm, effectively comparing the sampled input with binary-weighted fractions of the reference voltage (e.g.,  $V_{\text{REF}}/2$ ,  $V_{\text{REF}}/4$  ...  $V_{\text{REF}}/65536$ ) using a differential comparator. At the end of conversion, the CDAC output approximates the sampled analog input. The ADC control logic then prepares the 16-bit digital output code for parallel or serial transfer.

### TRANSFER FUNCTION

The LTC2389-16 digitizes the full-scale voltage of  $2 \bullet V_{\text{REF}}$  in fully-differential mode and  $V_{\text{REF}}$  in pseudo-differential mode, into  $2^{16}$  levels. With  $V_{\text{REF}} = 4.096\text{V}$ , the resulting LSB sizes in fully-differential and pseudo-differential mode are  $125\mu\text{V}$  and  $62.5\mu\text{V}$ , respectively. The binary format of the conversion result depends on the logic levels on pins  $\overline{\text{PD}}/\overline{\text{FD}}$  and  $\text{OB}/\overline{2\text{C}}$ , as described in Table 2. The ideal two's complement transfer function is shown in Figure 2, while the ideal straight binary transfer function is shown in Figure 3. The ideal offset binary transfer function can be obtained from the two's complement transfer function by inverting the most significant bit (MSB) of each output code.

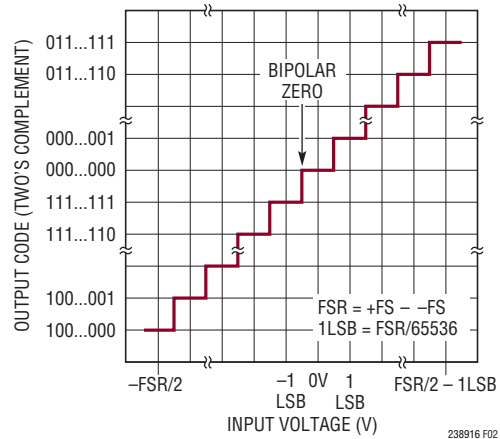

**Figure 2. LTC2389-16 Two's Complement Transfer Function. Offset Binary Transfer Function Can Be Obtained by Inverting the Most Significant Bit (MSB) of Each Output Code**

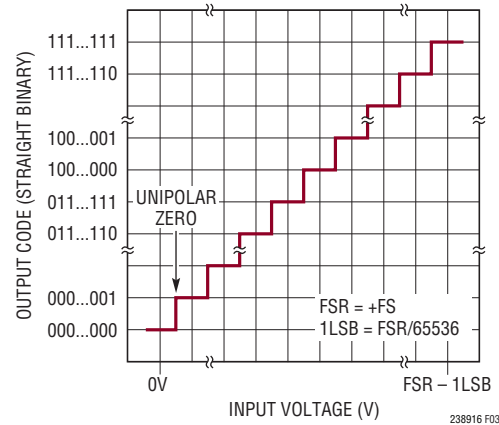

**Figure 3. LTC2389-16 Straight Binary Transfer Function**

## APPLICATIONS INFORMATION

### ANALOG INPUT

The analog inputs of the LTC2389-16 can be pin configured to accept one of three input voltage ranges: fully differential ( $\pm 4.096\text{V}$ ), pseudo-differential unipolar ( $0\text{V}$  to  $4.096\text{V}$ ), and pseudo-differential bipolar ( $\pm 2.048\text{V}$ ). In all three ranges, the ADC samples and digitizes the voltage difference between the two analog input pins ( $\text{IN}^+ - \text{IN}^-$ ), and any unwanted signal that is common to both inputs is reduced by the common mode rejection ratio (CMRR) of the ADC. Independent of the selected range, the analog inputs can be modeled by the equivalent circuit shown in Figure 4. The diodes at the input provide ESD protection. In the acquisition phase, each input sees approximately  $40\text{pF}$  ( $\text{C}_{\text{IN}}$ ) from the sampling CDAC in series with  $40\Omega$  ( $\text{R}_{\text{IN}}$ ) from the on-resistance of the sampling switch. The inputs draw a small current spike while charging the  $\text{C}_{\text{IN}}$  capacitors during acquisition. During conversion, the analog inputs draw only a small leakage current.

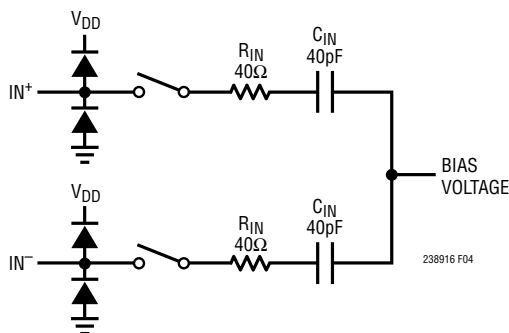

Figure 4. Equivalent Circuit for the Differential Analog Input of the LTC2389-16

### Fully Differential Input Range

The fully differential input range provides the widest input signal swing, configuring the ADC to digitize the differential analog input voltage ( $\text{IN}^+ - \text{IN}^-$ ) over a span of ( $\pm V_{\text{REF}}$ ). In this range, the  $\text{IN}^+$  and  $\text{IN}^-$  pins should be driven 180 degrees out-of-phase with respect to each other, centered around a common mode voltage  $(\text{IN}^+ + \text{IN}^-)/2$  that is restricted to  $(V_{\text{REF}}/2 \pm 0.1\text{V})$ . Both the  $\text{IN}^+$  and  $\text{IN}^-$  pins are allowed to swing from  $(\text{GND} - 0.1\text{V})$  to  $(V_{\text{REF}} + 0.1\text{V})$ . Unwanted signals common to both inputs are reduced by the CMRR of the ADC.

### Pseudo-Differential Unipolar Input Range

In the pseudo-differential unipolar input range, the ADC digitizes the differential analog input voltage ( $\text{IN}^+ - \text{IN}^-$ ) over a span of ( $0\text{V}$  to  $V_{\text{REF}}$ ). In this range, a single-ended unipolar input signal, driven on the  $\text{IN}^+$  pin, is measured with respect to the signal ground reference level, driven on the  $\text{IN}^-$  pin. The  $\text{IN}^+$  pin is allowed to swing from  $(\text{GND} - 0.1\text{V})$  to  $(V_{\text{REF}} + 0.1\text{V})$ , while the  $\text{IN}^-$  pin is restricted to  $(\text{GND} \pm 0.1\text{V})$ . Unwanted signals common to both inputs are reduced by the CMRR of the ADC.

### Pseudo-Differential Bipolar Input Range

In the pseudo-differential bipolar input range, the ADC digitizes the differential analog input voltage ( $\text{IN}^+ - \text{IN}^-$ ) over a span of ( $\pm V_{\text{REF}}/2$ ). In this range, a single-ended bipolar input signal, driven on the  $\text{IN}^+$  pin, is measured with respect to the signal mid-scale reference level, driven on the  $\text{IN}^-$  pin. The  $\text{IN}^+$  pin is allowed to swing from  $(\text{GND} - 0.1\text{V})$  to  $(V_{\text{REF}} + 0.1\text{V})$ , while the  $\text{IN}^-$  pin is restricted to  $(V_{\text{REF}}/2 \pm 0.1\text{V})$ . Unwanted signals common to both inputs are reduced by the CMRR of the ADC.

### INPUT DRIVE CIRCUITS

A low impedance source can directly drive the high impedance inputs of the LTC2389-16 without gain error. A high impedance source should be buffered to minimize settling time during acquisition and to optimize the distortion performance of the ADC. Minimizing settling time is important even for DC signals because the ADC inputs draw a current spike when entering acquisition.

For best performance, a buffer amplifier should be used to drive the analog inputs of the LTC2389-16. The amplifier provides low output impedance enabling fast settling of the analog signal during the acquisition phase. It also provides isolation between the signal source and the current spike drawn by the ADC inputs when entering acquisition.

## APPLICATIONS INFORMATION

### Input Filtering

The noise and distortion of the buffer amplifier and other supporting circuitry must be considered since they add to the ADC noise and distortion. A buffer amplifier with low noise density must be selected to minimize SNR degradation. A filter network should be placed between the buffer output and ADC input to both minimize the noise contribution of the buffer and reduce disturbances reflected into the buffer from ADC sampling transients. A simple one-pole lowpass RC filter is sufficient for many applications. It is important that the RC time constants of this filter be small enough to allow the analog inputs to completely settle to 16-bit resolution within the ADC acquisition time ( $t_{ACQ}$ ), as insufficient settling can limit INL and THD performance. In many applications an RC time constant of 10ns is fast enough to allow for sufficient transient settling during acquisition while simultaneously filtering driver wideband noise.

Often it is also beneficial to add small series resistors between the primary lowpass RC filter and the ADC inputs. These resistors, in conjunction with the ADC sampling capacitance  $C_{IN}$  and sampling switch resistance  $R_{IN}$ , form a second lowpass RC filter which further limits high-frequency driver noise as well as reduces the magnitude of the current spike drawn by the analog inputs when entering acquisition. The time constant of this secondary

lowpass filter also directly affects settling of the analog inputs during acquisition and must be kept fast. In many applications 49.9 $\Omega$  series resistors allow for sufficient transient settling during acquisition while providing useful additional filtering of wideband driver noise.

High quality capacitors and resistors should be used in the RC filters since these components can add distortion. NPO and silver mica type dielectric capacitors have excellent linearity. Carbon surface mount resistors can generate distortion from self heating and from damage that may occur during soldering. Metal film surface mount resistors are much less susceptible to both problems.

### Fully Differential Inputs

The LTC2389-16 accepts fully differential input signals directly. For most fully differential applications, it is recommended that the LTC2389-16 be driven using the LT6201 ADC driver configured as two unity-gain buffers, as shown in Figure 5a. The LT6201 combines fast settling and good DC linearity with a  $0.95\text{nV}/\sqrt{\text{Hz}}$  input-referred noise density, enabling it to achieve the full ADC data sheet SNR and THD specifications, as shown in the FFT plot in Figure 5b. This topology may also be used to buffer single-ended signals and achieves full ADC data sheet SNR and THD specifications in both pseudo-differential input modes, as shown in the FFT plots in Figures 5c and 5d.

APPLICATIONS INFORMATION

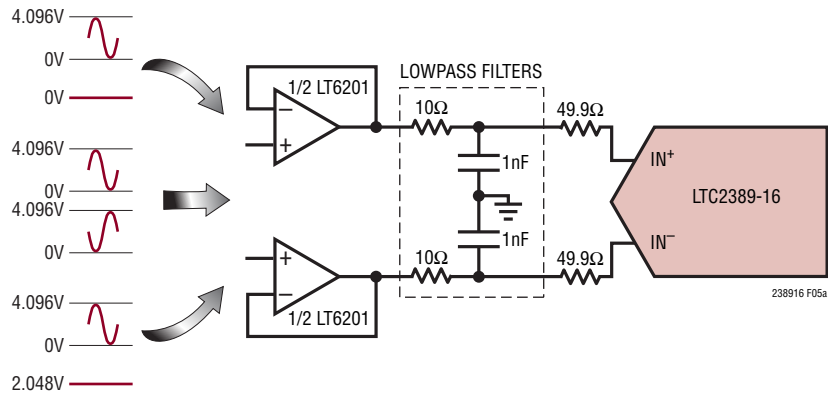

Figure 5a. LT6201 Buffering a Fully-Differential or Single-Ended Signal Source

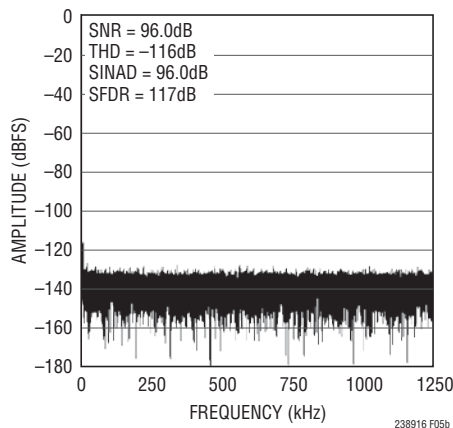

Figure 5b. 32k Point FFT  $f_{\text{SMPL}} = 2.5\text{Mpsps}$ ,  $f_{\text{IN}} = 2\text{kHz}$ , for Circuit Shown in Figure 5a; Driven with Fully Differential Inputs

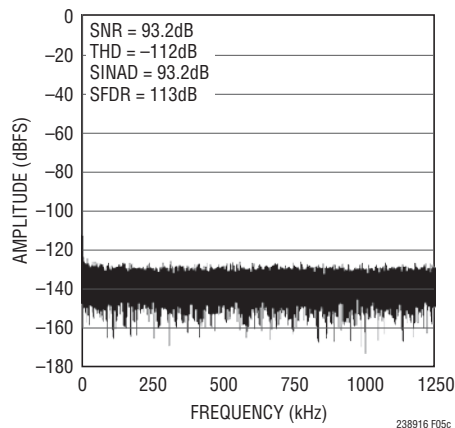

Figure 5c. 32k Point FFT  $f_{\text{SMPL}} = 2.5\text{Mpsps}$ ,  $f_{\text{IN}} = 2\text{kHz}$ , for Circuit Shown in Figure 5a; Driven with Unipolar Inputs

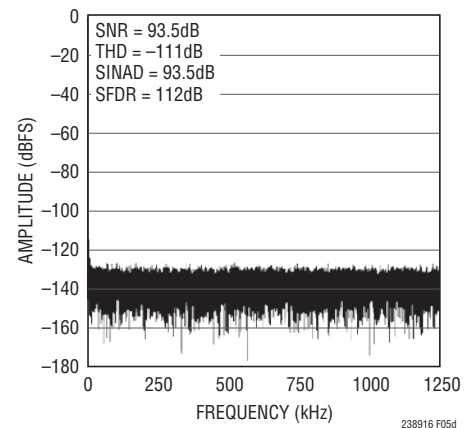

Figure 5d. 32k Point FFT  $f_{\text{SMPL}} = 2.5\text{Mpsps}$ ,  $f_{\text{IN}} = 2\text{kHz}$ , for Circuit Shown in Figure 5a; Driven with Bipolar Inputs

## APPLICATIONS INFORMATION

In applications where slightly degraded SNR and THD performance is acceptable, it is possible to drive the LTC2389-16 using the lower power LT6231 ADC driver configured as two unity-gain buffers, as shown in Figure 6a. The RC time constant of the output lowpass filter is larger in this topology to limit the high frequency

noise contribution of the LT6231. As shown in the FFT plots in Figures 6b-6d, this circuit achieves 95.7dB SNR and -115dB THD in fully differential input mode, 92.4dB SNR and -112dB THD in unipolar input mode, and 92.7dB SNR and -110dB THD in bipolar input mode.

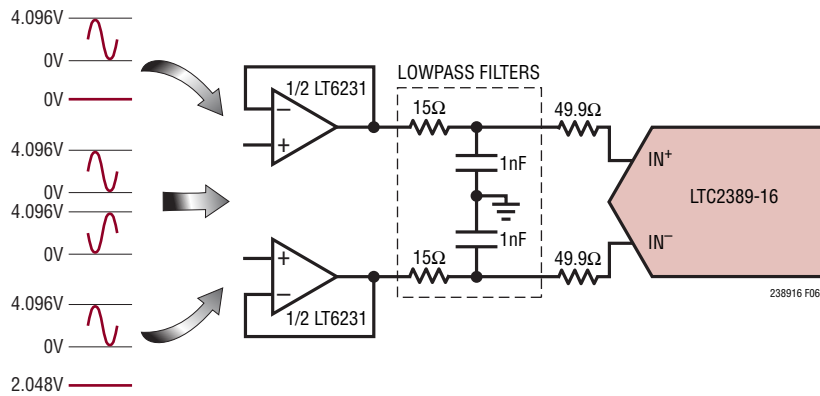

Figure 6a. LT6231 Buffering a Fully-Differential or Single-Ended Signal Source

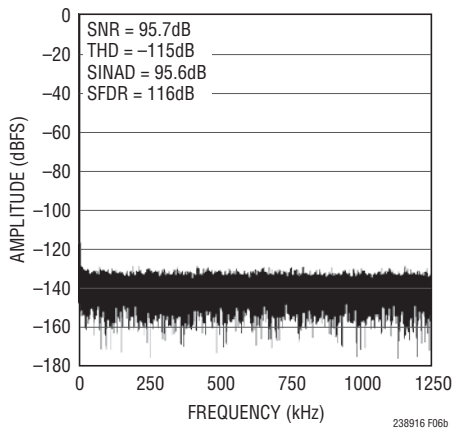

Figure 6b. 32k Point FFT  $f_{\text{SMPL}} = 2.5\text{Mpsps}$ ,  $f_{\text{IN}} = 2\text{kHz}$ , for Circuit Shown in Figure 6a; Driven with Fully Differential Inputs

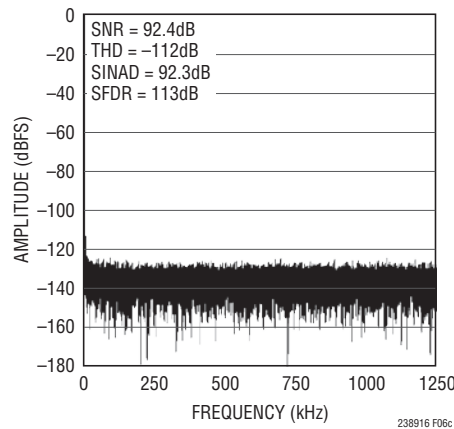

Figure 6c. 32k Point FFT  $f_{\text{SMPL}} = 2.5\text{Mpsps}$ ,  $f_{\text{IN}} = 2\text{kHz}$ , for Circuit Shown in Figure 6a; Driven with Unipolar Inputs

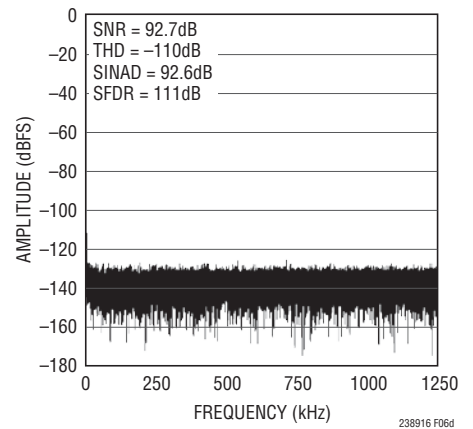

Figure 6d. 32k Point FFT  $f_{\text{SMPL}} = 2.5\text{Mpsps}$ ,  $f_{\text{IN}} = 2\text{kHz}$ , for Circuit Shown in Figure 6a; Driven with Bipolar Inputs

## APPLICATIONS INFORMATION

### Single-Ended to Differential Conversion

In some applications it may be desirable to convert a single-ended unipolar or bipolar signal to a fully-differential signal prior to driving the LTC2389-16 to take advantage of the higher SNR of the LTC2389-16 in fully differential input mode. The LT6201 ADC driver configured in the topology shown in Figure 7a can be used to convert a 0V to 4.096V single-ended input signal to a fully-differential

$\pm 4.096\text{V}$  output signal. The RC time constant of the output lowpass filters is chosen to allow for sufficient transient settling of the LTC2389-16 analog inputs during acquisition. This wide filter bandwidth, coupled with the relatively high wideband noise of the single-ended to differential conversion circuit, limits the achievable SNR of this topology to 95.6dB, as shown in the FFT plot in Figure 7b.

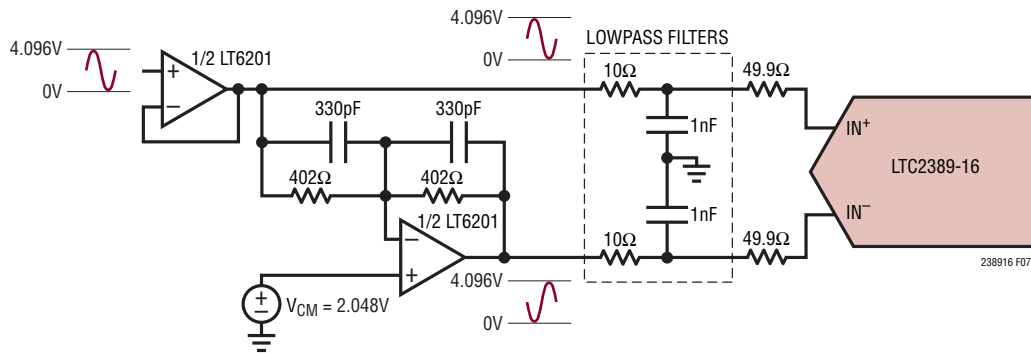

Figure 7a. LT6201 Converting a 0V to 4.096V Single-Ended Signal to a  $\pm 4.096\text{V}$  Fully-Differential Signal

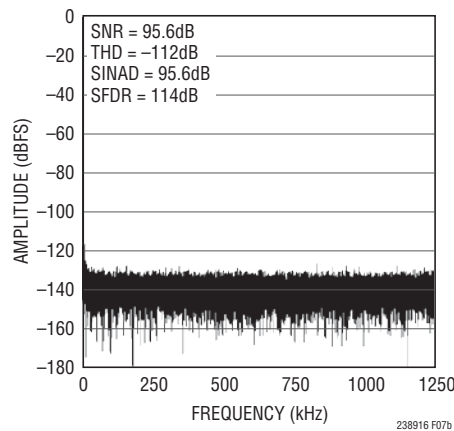
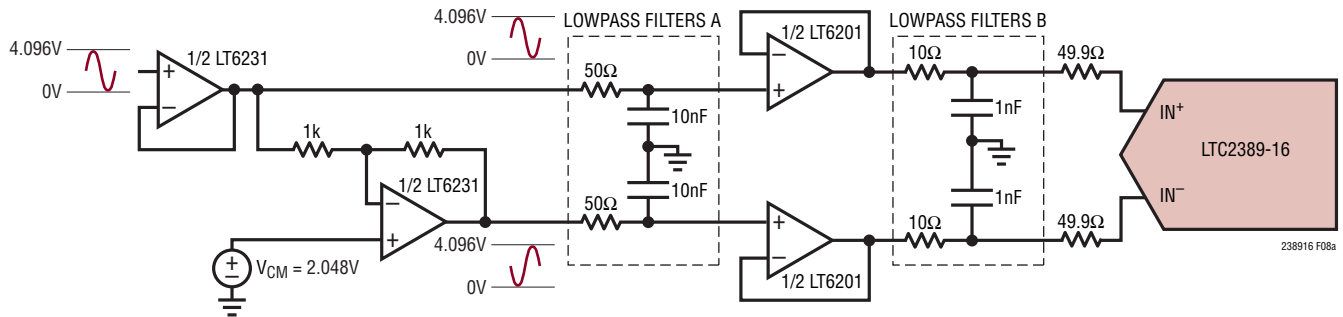

Figure 7b. 32k Point FFT  $f_{\text{SAMPL}} = 2.5\text{Mps}$ ,  $f_{\text{IN}} = 2\text{kHz}$ , for Circuit Shown in Figure 7a

## APPLICATIONS INFORMATION

An alternate single-ended to differential topology employing the LT6231 followed by the LT6201 is shown in Figure 8a. This topology enables additional band-limiting of the wideband noise of the single-ended to differential

conversion circuit using lowpass filters A without affecting the settling at the inputs of the LTC2389-16 during acquisition. This circuit achieves the full ADC data sheet SNR specifications, as shown in the FFT plot in Figure 8b.



**Figure 8a. LT6231 Converting a 0V to 4.096V Single-Ended Signal to a ±4.096V Fully-Differential Signal Followed by LT6201 Buffering Fully-Differential Signal**

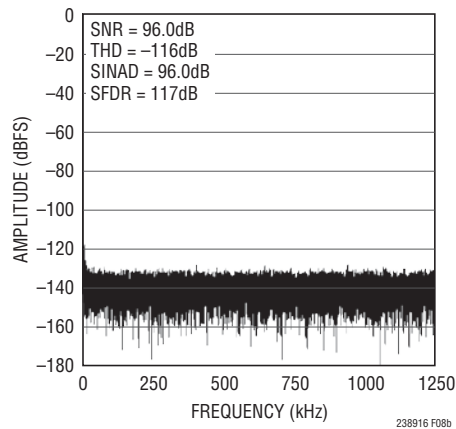

**Figure 8b. 32k Point FFT  $f_{\text{SMPL}} = 2.5\text{Mpsps}$ ,  $f_{\text{IN}} = 2\text{kHz}$ , for Circuit Shown in Figure 8a**



## APPLICATIONS INFORMATION

### Single-Ended Unipolar and Bipolar Inputs

The LTC2389-16 accepts both single-ended unipolar and single-ended bipolar input signals directly. For most single-ended applications, it is recommended that the LTC2389-16 be driven using the LT6200 ADC driver configured as a unity-gain buffer, as shown in Figure 9a. The

LT6200 combines fast settling and good DC linearity with a  $0.95\text{nV}/\sqrt{\text{Hz}}$  input-referred noise density, enabling it to achieve the full ADC data sheet SNR and THD specifications in both pseudo-differential input modes, as shown in the FFT plots in Figures 9b and 9c.

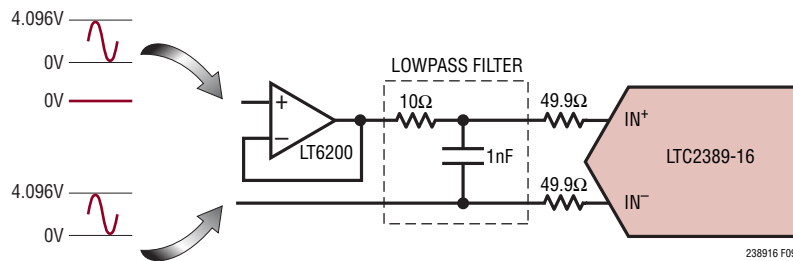

Figure 9a. LT6200 Buffering a Single-Ended Signal Source

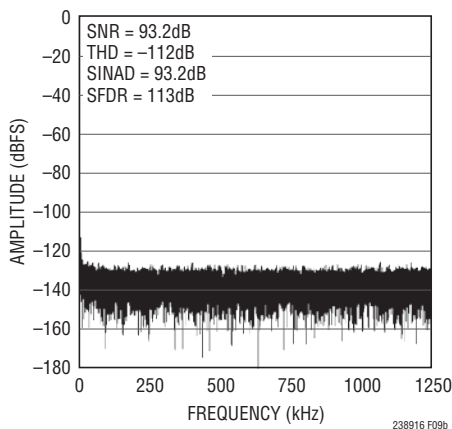

Figure 9b. 32k Point FFT  $f_{\text{SAMPL}} = 2.5\text{Mps}$ ,  $f_{\text{IN}} = 2\text{kHz}$ , for Circuit Shown in Figure 9a; Driven with Unipolar Inputs

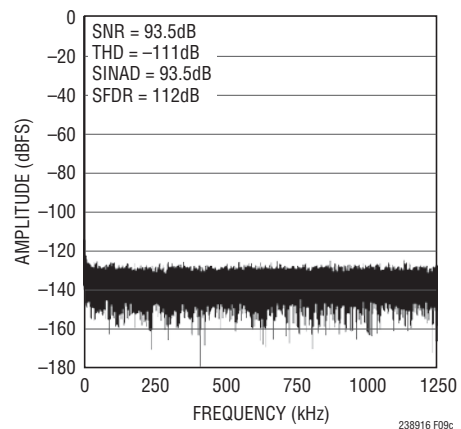

Figure 9c. 32k Point FFT  $f_{\text{SAMPL}} = 2.5\text{Mps}$ ,  $f_{\text{IN}} = 2\text{kHz}$ , for Circuit Shown in Figure 9a; Driven with Bipolar Inputs

## APPLICATIONS INFORMATION

In applications where slightly degraded SNR and THD performance is acceptable, it is possible to drive the LTC2389-16 using the lower power LT6230 ADC driver configured as a unity-gain buffer, as shown in Figure 10a. The RC time constant of the output lowpass filter is larger in this topology to limit the high frequency noise contribution of the LT6230. As shown in the FFT plots in Figures 10b and 10c, this circuit achieves 92.5dB SNR and -112dB THD in unipolar input mode and 92.8dB SNR and -111dB THD in bipolar input mode.

Note that in the circuits of Figures 9a and 10a, the source impedance of the signal applied to  $IN^-$  directly affects input settling time during signal acquisition. In single-ended applications where the impedance of this reference signal is intrinsically high, the dual-buffer approach shown in Figures 5a and 6a will provide for faster acquisition time and better distortion performance from the ADC.

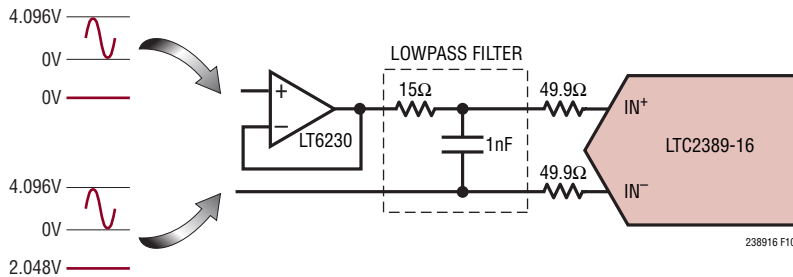

Figure 10a. The LT6230 Buffering a Single-Ended Signal Source

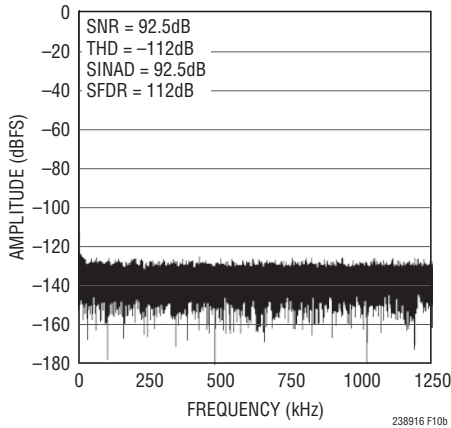

Figure 10b. 32k Point FFT  $f_{SMPL} = 2.5\text{Msps}$ ,  $f_{IN} = 2\text{kHz}$ , for Circuit Shown in Figure 10a; Driven with Unipolar Inputs

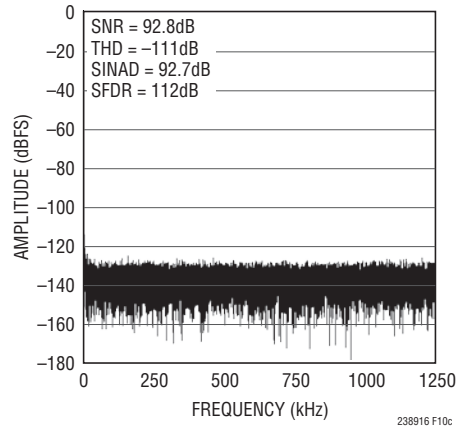

Figure 10c. 32k Point FFT  $f_{SMPL} = 2.5\text{Msps}$ ,  $f_{IN} = 2\text{kHz}$ , for Circuit Shown in Figure 10a; Driven with Bipolar Inputs

## APPLICATIONS INFORMATION

### ADC REFERENCE

A low noise, low temperature drift reference is critical to achieving the full data sheet performance of the ADC. The LTC2389-16 provides an excellent internal reference with a  $\pm 20\text{ppm}/^\circ\text{C}$  (maximum) temperature coefficient. If even better accuracy is required, an external reference can be used. In both cases, the high speed, low noise internal reference buffer is employed and cannot be bypassed. The buffer contributes a signal-dependent noise term to the converter with a typical standard deviation of:

$$\frac{(V_{\text{IN}+} - V_{\text{IN}-})}{V_{\text{REF}}} \cdot 16\mu\text{V}_{\text{RMS}},$$

which accounts for the increase in transition noise between zero-scale and full-scale inputs. The reference voltage applied to REFIN adds a similar signal-dependent noise term, but its magnitude is limited by a 4kHz (typical) lowpass filter in the internal buffer, making this term negligible in most cases.

### Internal Reference

To use the internal reference, simply tie the REFOUT and REFIN pins together. This connects the 4.096V output of the internal reference to the input of the internal reference buffer. The output impedance of the internal reference is approximately 2.3k $\Omega$  and the input impedance of the internal reference buffer is about 74k $\Omega$ . It is recommended REFIN be bypassed to REFSENSE with a 1 $\mu\text{F}$ , or larger, capacitor to filter the output noise of the internal reference. Do not ground the REFSENSE pin when using the internal reference.

### External Reference

An external reference can be used with the LTC2389-16 when even higher performance is required. The LTC6655 offers 0.025% (maximum) initial accuracy and 2ppm/ $^\circ\text{C}$  (maximum) temperature coefficient for high precision applications. The LTC6655 is fully specified over the H-grade temperature range and complements the extended temperature operation of the LTC2389-16 up to 125 $^\circ\text{C}$ . When using an external reference, connect the reference output to the REFIN pin and connect the REFOUT pin to ground. The REFSENSE pin should be connected to the ground of the external reference.

### DYNAMIC PERFORMANCE

Fast fourier transform (FFT) techniques are used to test the ADC's frequency response, distortion and noise at the rated throughput. By applying a low distortion sine wave and analyzing the digital output using an FFT algorithm, the ADC's spectral content can be examined for frequencies outside the fundamental. The LTC2389-16 provides guaranteed tested limits for both AC distortion and noise measurements.

### Signal-to-Noise and Distortion Ratio (SINAD)

The signal-to-noise and distortion ratio (SINAD) is the ratio between the RMS amplitude of the fundamental input frequency and the RMS amplitude of all other frequency components at the A/D output. The output is band-limited to frequencies from above DC and below half the sampling frequency. Figure 11 shows that the LTC2389-16 achieves a typical SINAD of 96.0dB (fully differential) at a 2.5MHz sampling rate with a 2kHz input.

### Signal-to-Noise Ratio (SNR)

The signal-to-noise ratio (SNR) is the ratio between the RMS amplitude of the fundamental input frequency and the RMS amplitude of all other frequency components except the first five harmonics and DC. Figure 11 shows that the LTC2389-16 achieves a typical SNR of 96.0dB (fully differential) at a 2.5MHz sampling rate with a 2kHz input.

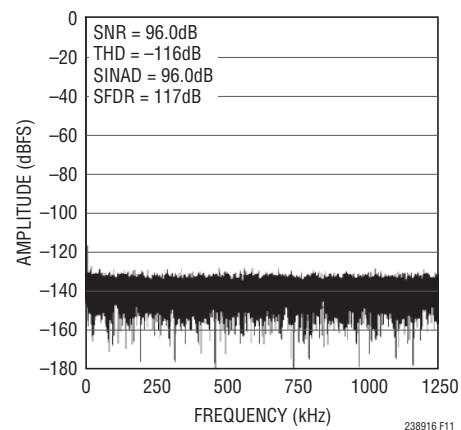

Figure 11. 32k Point FFT of LTC2389-16,  $f_{\text{SAMPL}} = 2.5\text{MSPS}$ ,  $f_{\text{IN}} = 2\text{kHz}$

## APPLICATIONS INFORMATION

### Total Harmonic Distortion (THD)

Total harmonic distortion (THD) is the ratio of the RMS sum of all harmonics of the input signal to the fundamental itself. The out-of-band harmonics alias into the frequency band between DC and half the sampling frequency ( $f_{\text{SAMPL}}/2$ ). THD is expressed as:

$$\text{THD} = 20 \log \frac{\sqrt{V_2^2 + V_3^2 + V_4^2 + \dots + V_N^2}}{V_1}$$

where  $V_1$  is the RMS amplitude of the fundamental frequency and  $V_2$  through  $V_N$  are the amplitudes of the second through Nth harmonics, respectively. Figure 11 shows that the LTC2389-16 achieves a typical THD of  $-116\text{dB}$  (fully differential) at a  $2.5\text{MHz}$  sampling rate with a  $2\text{kHz}$  input.

### POWER CONSIDERATIONS

The LTC2389-16 provides two sets of power supply pins: the  $5\text{V}$  core power supply ( $V_{\text{DD}}$ ) and the digital input/output interface power supply ( $OV_{\text{DD}}$ ). The flexible  $OV_{\text{DD}}$  supply allows the LTC2389-16 to communicate with any digital logic operating between  $1.8\text{V}$  and  $5\text{V}$ , including  $2.5\text{V}$  and  $3.3\text{V}$  systems. Both the  $V_{\text{DD}}$  and  $OV_{\text{DD}}$  supply networks should be bypassed to GND with a  $0.1\mu\text{F}$  ceramic capacitor close to each pin and a  $10\mu\text{F}$  ceramic capacitor in parallel.

### Power Supply Sequencing

The LTC2389-16 does not have any specific power supply sequencing requirements. Care should be taken to adhere to the maximum voltage relationships described in the Absolute Maximum Ratings section. The LTC2389-16 has an internal power-on reset (POR) circuit which resets the converter on initial power-up or whenever the power supply voltage drops below  $2.5\text{V}$ . Once the supply voltage re-enters the nominal supply voltage range, the POR reinitializes the ADC. With the POR, the result of the first conversion is valid after power-up as long as the reference has been given sufficient time to settle.

### Nap Mode

The LTC2389-16 can be put into nap mode after a conversion has been completed to reduce the power consumption between conversions. In this mode some of the circuitry on the device is turned off. Nap mode is enabled by keeping  $\overline{\text{CNVST}}$  low between conversions, as shown in Figure 12. To initiate a new conversion after entering nap mode, bring  $\overline{\text{CNVST}}$  high and hold for at least  $200\text{ns}$  before bringing it low again.

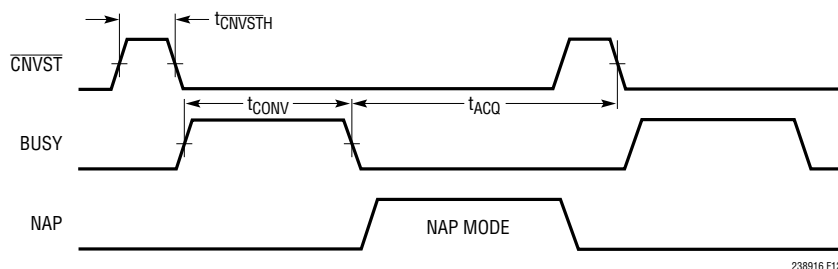

Figure 12. Nap Mode Timing for the LTC2389-16

## APPLICATIONS INFORMATION

### Power Shutdown Mode

When PD is tied high, the LTC2389-16 enters power shutdown. In this state, all internal functions, including the reference, are turned off and subsequent conversion requests are ignored. Before entering power shutdown, the digital output data should be read. If a request for power shutdown occurs during a conversion, the conversion will finish and then the device will power down, but the data from that conversion should be read only after power shutdown mode has ended. In this mode, power consumption drops to a typical value of  $75\mu\text{W}$  from  $162.5\text{mW}$ . This mode can be used if the LTC2389-16 is inactive for a long period of time and the user wants to minimize power dissipation.

### Recovery From Power Shutdown Mode

To end the power shutdown and begin powering up the internal circuitry, return the PD pin to a low level. If the internal reference is used, the  $2.3\text{k}\Omega$  output impedance with the  $1\mu\text{F}$  bypass capacitor on the REFIN/REFOUT pins will be the main time constant for the power-on recovery time. If an external reference is used, typically allow 5ms for recovery before initiating a new conversion.

### Power Dissipation vs Sampling Frequency

When nap mode is employed, the power dissipation of the LTC2389-16 will decrease as the sampling frequency is reduced, as shown in Figure 13. This decrease in average power dissipation occurs because a portion of the circuitry on the LTC2389-16 is turned off during nap

mode and the fraction of the conversion cycle ( $t_{\text{CYC}}$ ) spent napping increases as the sampling frequency ( $f_{\text{SMPL}}$ ) is decreased.

## TIMING AND CONTROL

### $\overline{\text{CNVST}}$ Timing

The LTC2389-16 conversion is controlled by  $\overline{\text{CNVST}}$ . A falling edge on  $\overline{\text{CNVST}}$  initiates the conversion process, which once begun, cannot be restarted until the conversion is complete. For optimum performance,  $\overline{\text{CNVST}}$  should be driven by a clean, low jitter signal and transitions on data I/O lines should be avoided leading up to the falling edge of  $\overline{\text{CNVST}}$ . Converter status is indicated by the BUSY output, which remains high while the conversion is in progress. Once  $\overline{\text{CNVST}}$  is brought low to begin a conversion, it should be returned high either within 40ns from the start of the conversion or after the conversion is complete to ensure no errors occur in the digitized results. The  $\overline{\text{CNVST}}$  timing required to take advantage of the reduced power nap mode of operation is described in the Nap Mode section.

### Internal Conversion Clock

The LTC2389-16 has an internal clock that is trimmed to achieve a maximum conversion time of 310ns. No external adjustments are required and with a minimum acquisition time of 77ns, a throughput performance of 2.5MSPS is guaranteed in the parallel output modes.

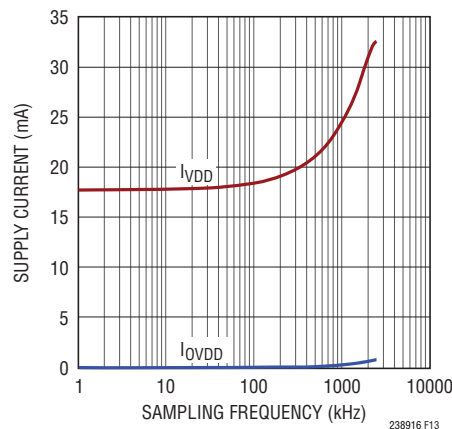

**Figure 13. Supply Current vs Sampling Frequency. Power Dissipation of the LTC2389-16 Decreases with Decreasing Sampling Frequency**

## APPLICATIONS INFORMATION

### DIGITAL INTERFACE

To accommodate a variety of application-specific processor and FPGA data bus widths, the LTC2389-16 output bus may be configured to operate in either 16-bit parallel, 8-bit parallel or serial modes, as described in Table 1. The flexible  $OV_{DD}$  supply allows the LTC2389-16 to communicate with any digital logic operating between 1.8V and 5V, including 2.5V and 3.3V systems.

#### 16-Bit Parallel Bus Configuration

In applications such as FPGA and CPLD based solutions or 16-bit microcontroller based solutions where a full 16-bit wide parallel data bus is available, the LTC2389-16 is capable of providing each conversion result  $R[15:0]$  as one 16-bit word on pins  $D[15:0]$ . To select this bus configuration, pin  $MODE0$  should be driven to  $MODE0 = 0$  and pin  $A1$  should be driven to  $A1 = 0$ , as described in Table 1. If the application does not require the bus to be shared, drive the chip select pin  $\overline{CS} = 0$  to enable the LTC2389-16 to drive the bus continuously, as shown in Figure 14. In applications where the bus must be shared, drive  $\overline{CS} = 1$  when other devices are using the bus to Hi-Z the LTC2389-16 bus pins and drive  $\overline{CS} = 0$  to allow the LTC2389-16 to drive the bus, as shown in Figures 15 and 16.

#### 8-Bit Parallel Bus Configuration

In applications such as 8-bit microcontroller based solutions where an 8-bit wide parallel data bus is available, the LTC2389-16 is capable of providing each conversion result  $R[15:0]$  in two 8-bit words on pins  $D[15:8]$ . To select this bus configuration, pin  $MODE0$  should be driven to  $MODE0 = 0$ , as described in Table 1. In this configuration, address input pin  $A1$  controls whether the upper byte  $R[15:8]$  or the lower byte  $R[7:0]$  of the conversion result is driven on  $D[15:8]$ , as shown in Figure 17. Note that, as shown in Table 1,  $D[7:0]$  also functions as an 8-bit wide parallel bus with  $A1$  providing control of the opposite polarity as it does on  $D[15:8]$ . Use of  $D[7:0]$  as an 8-bit parallel bus should be avoided in applications where it is important to maintain compatibility with 18-bit versions of the LTC2389 family, as described in the Pin Compatibility with LTC2389-18 section. The chip select pin,  $\overline{CS}$ , enables the 8-bit parallel bus to be shared between multiple devices. See the 16-Bit Parallel Bus Configuration section for further details.

# APPLICATIONS INFORMATION

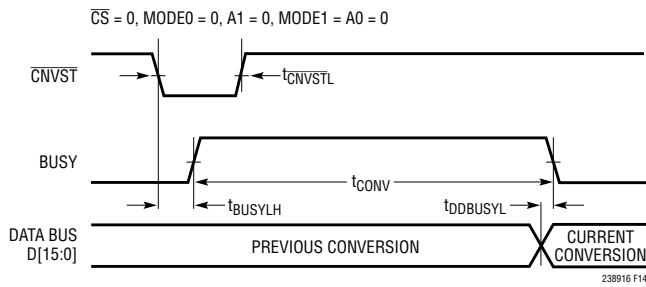

**Figure 14. Read the Parallel Data Continuously. The Data Bus Is Always Driven and Cannot Be Shared**

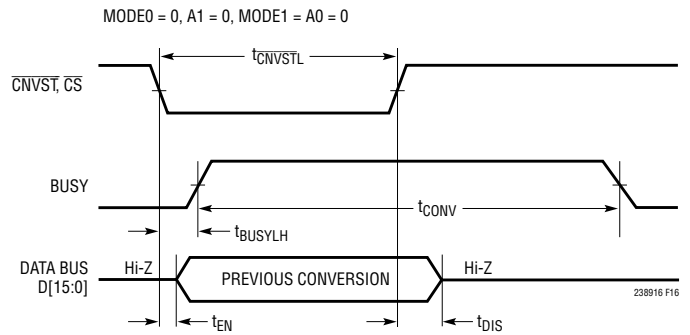

**Figure 16. Read the Parallel Data During the Following Conversion**

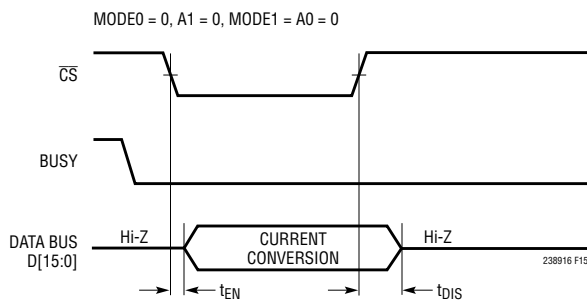

**Figure 15. Read the Parallel Data After the Conversion**

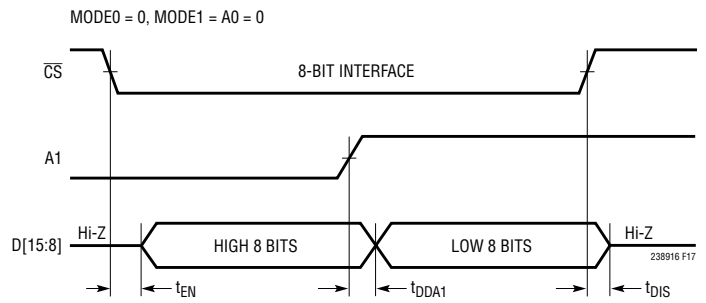

**Figure 17. 8-Bit Parallel Interface Using A1 Pin**

APPLICATIONS INFORMATION

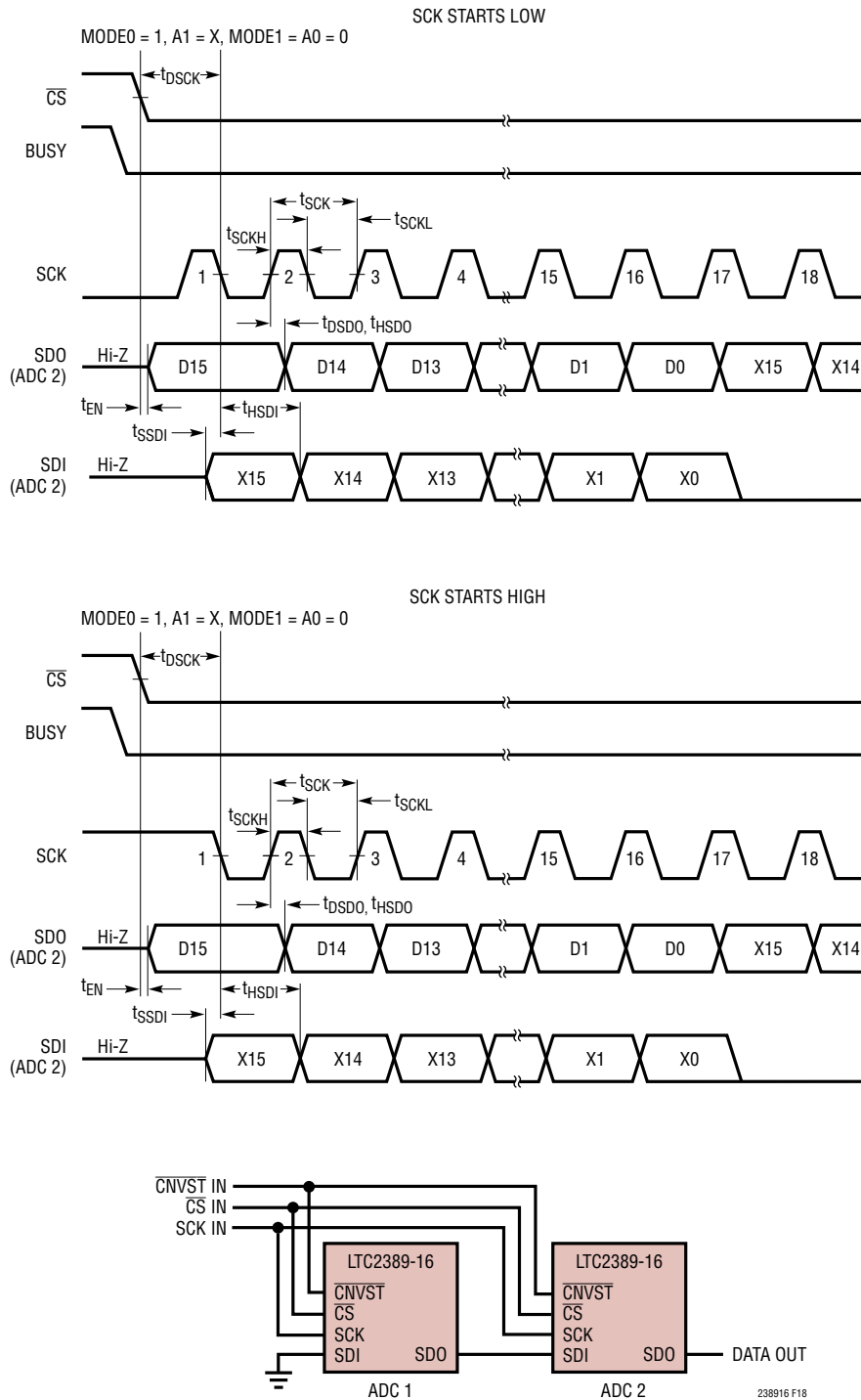

Figure 18. Serial Interface with External Clock. Read After the Conversion. Daisy Chain Multiple Converters



## APPLICATIONS INFORMATION

### Serial Bus Configuration

In applications where a serial bus is required to minimize the data bus width, the LTC2389-16 is capable of providing each conversion result  $R[15:0]$  serially on pin D10/SDO. To select this bus configuration, pin MODE0 should be driven to  $\text{MODE0} = 1$ , as described in Table 1. Address input pin A1 has no effect on the parsing or presentation of serial conversion data. As shown in Figure 18, the serial output data is presented on the SDO pin in response to an external shift clock input applied to the SCK pin. The data on SDO changes state following rising edges of SCK. The one exception to this behavior is that D15 remains valid until the first SCK rising edge following the first SCK falling edge. If  $\overline{\text{CS}}$  is used to gate the serial output data, the full conversion result should be read before  $\overline{\text{CS}}$  is returned to a high level. For best performance, do not clock serial data out when BUSY is high. The SDI input pin can be used to daisy chain multiple converters, as shown in Figure 18. In this figure, two devices are cascaded with the MSB of ADC1 appearing at the serial output of ADC2 after a 16

SCK cycle delay. The serial output of ADC1 is clocked into ADC2 on the falling edges of SCK. This is useful in applications where hardware constraints limit the number of data lines available to interface with multiple converters.

### Data Format

The binary format of the conversion result depends on the state of pins PD/ $\overline{\text{FD}}$  and OB/ $\overline{2\text{C}}$ , as described in Table 2. These pins are active in both the parallel and serial modes of operation.

### Reset

As shown in Figure 19, when the RESET pin is high, the LTC2389-16 is reset and the data bus is put into a high impedance mode. If this occurs during a conversion, the conversion is immediately halted. In reset, requests for new conversions are ignored. Once RESET returns low, the LTC2389-16 is ready to start a new conversion after the acquisition time has been met.

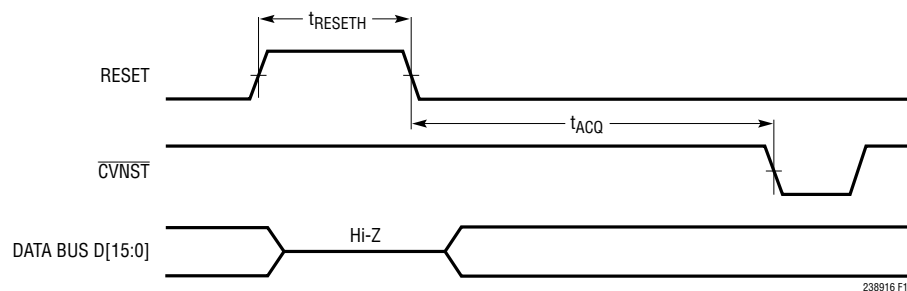

Figure 19. RESET Pin Timing

## APPLICATIONS INFORMATION

### BOARD LAYOUT

To obtain the best performance from the LTC2389-16, a printed circuit board (PCB) is recommended. Layout for the printed circuit board should ensure the digital and analog signal lines are separated as much as possible. In particular, care should be taken not to run any digital clocks or signals alongside analog signals or underneath the ADC.

### Pin Compatibility with LTC2389-18

To ensure a board layout intended for use with the LTC2389-16 is also compatible with 18-bit versions of the LTC2389 family, the design should maintain the ability to drive Pins 4 (MODE0) and 5 (MODE1) to both logic high and logic low levels, to dynamically drive Pins 7 (A0) and 8 (A1) to both logic high and logic low levels, and to read dynamic data driven by the LTC2389-18 on Pins 7 (A0)

and 8 (A1). Additionally, if the 8-bit parallel bus configuration is used, the upper byte Pins 28 through 21 (D[15:8]) of the output data bus should be used to read the conversion results. Simplifications to these constraints are possible based on the specific application. For further details on the operation of the LTC2389-18, please refer to the associated data sheet.

### Recommended Layout

The following is an example of a recommended PCB layout. A single solid ground plane is used. Bypass capacitors to the supplies are placed as close as possible to the supply pins. Low impedance common returns for these bypass capacitors are essential to the low noise operation of the ADC. The analog input traces are shielded by ground. For more details and information refer to DC1826A-E, the evaluation kit for the LTC2389-16.

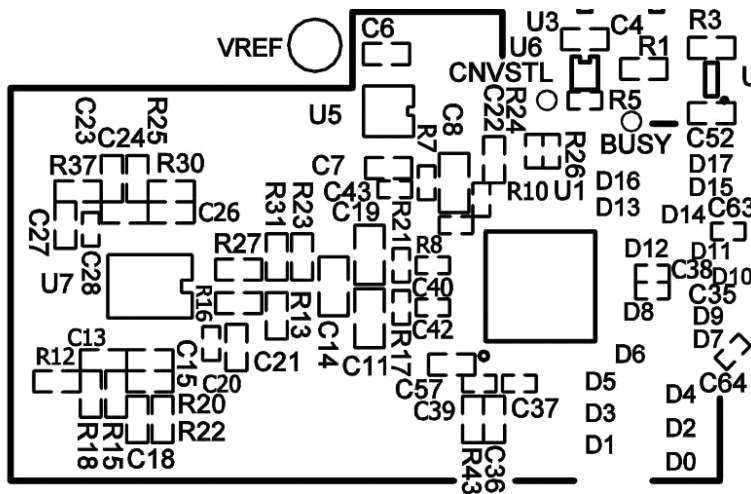

238916 F20

Partial Top Silkscreen

**APPLICATIONS INFORMATION**

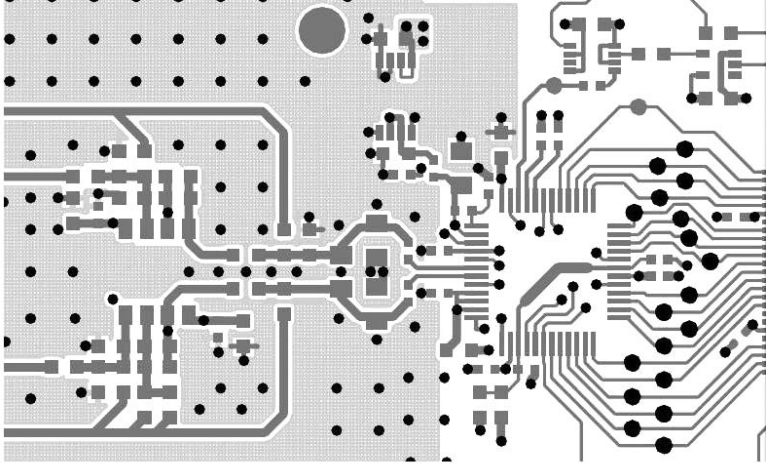

238916 F21

**Partial Layer 1 Component Side**

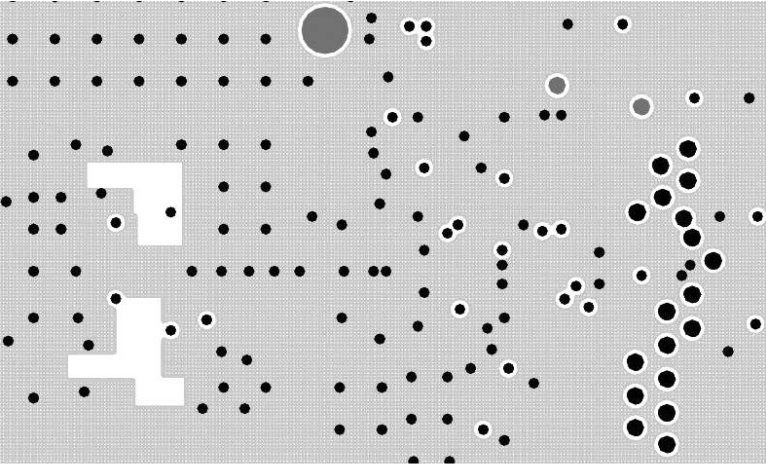

238916 F22

**Partial Layer 2 Ground Plane**

# APPLICATIONS INFORMATION

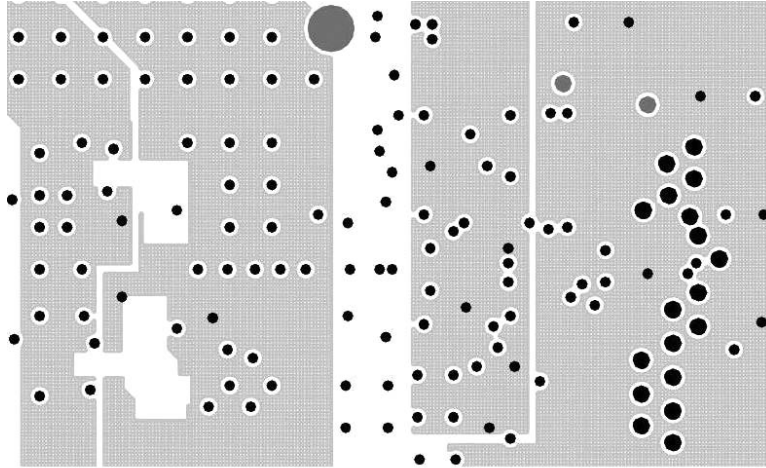

238916 F23

Partial Layer 3 Power Plane

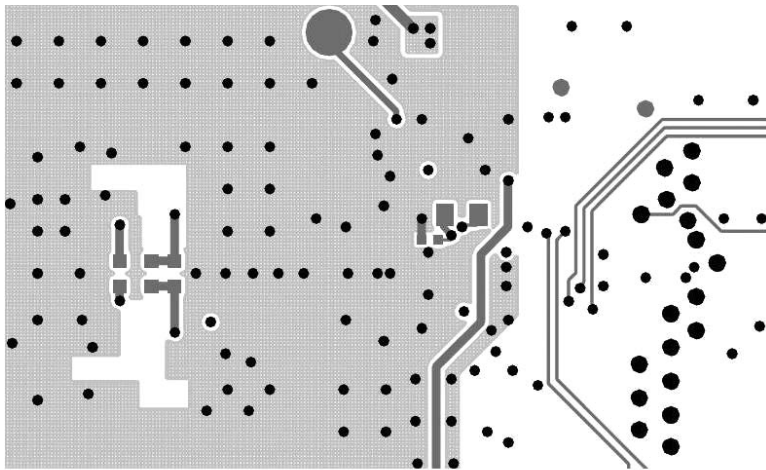

238916 F24

Partial Layer 4 Bottom Layer



238916 F25

Bottom Silk Partial

APPLICATIONS INFORMATION

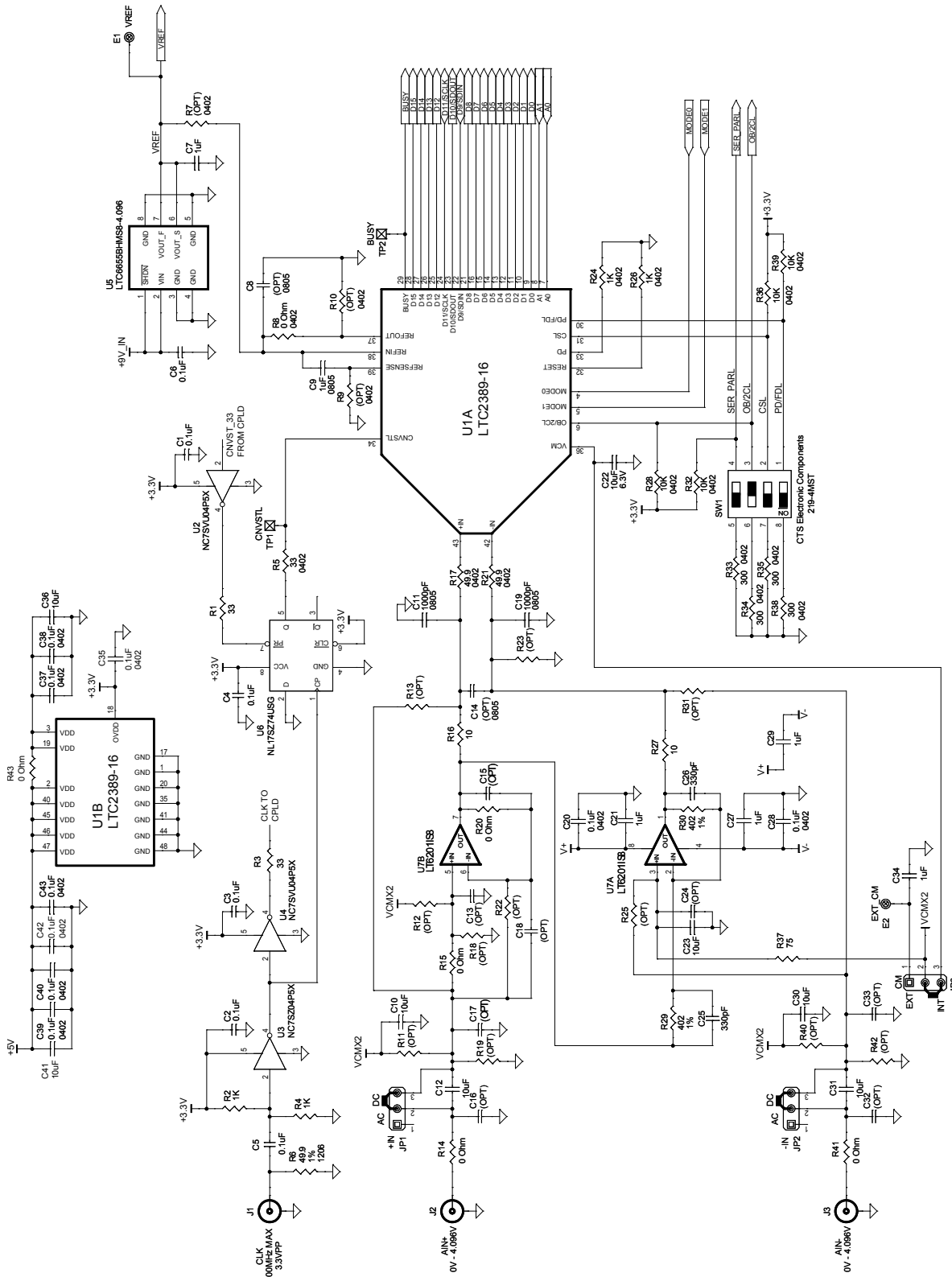

Partial Schematic of Demo Board

## PACKAGE DESCRIPTION

Please refer to <http://www.linear.com/designtools/packaging/> for the most recent package drawings.

### LX Package 48-Lead Plastic LQFP (7mm × 7mm) (Reference LTC DWG # 05-08-1760 Rev 0)

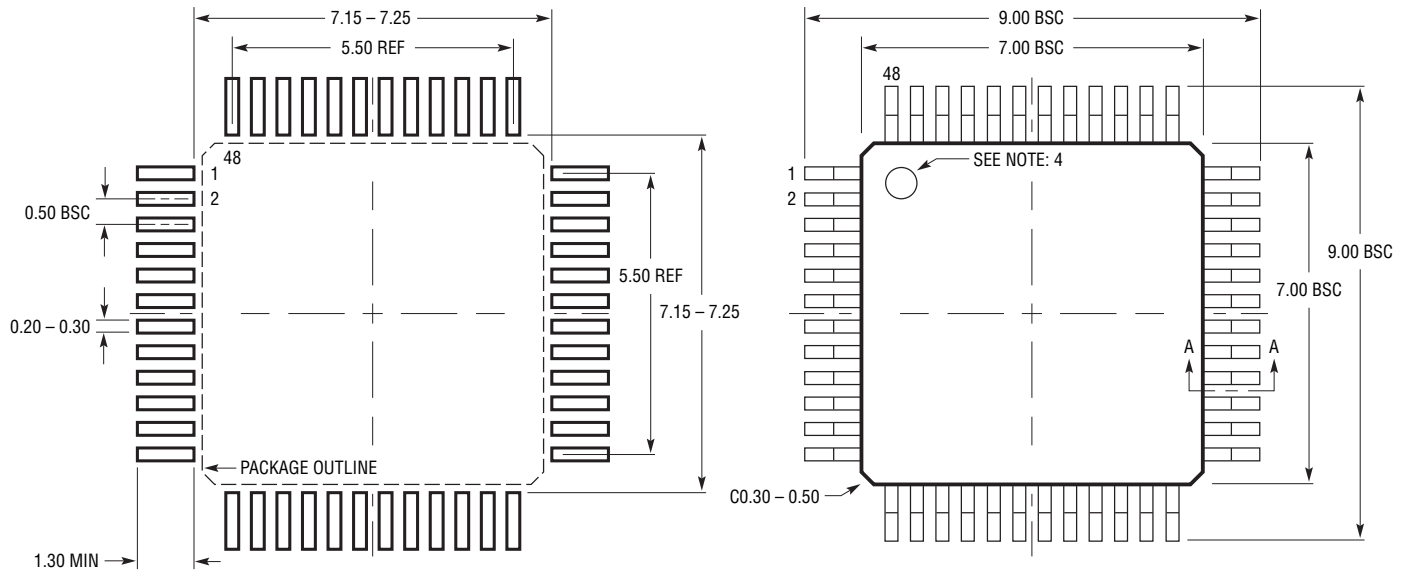

RECOMMENDED SOLDER PAD LAYOUT  
APPLY SOLDER MASK TO AREAS THAT ARE NOT SOLDERED

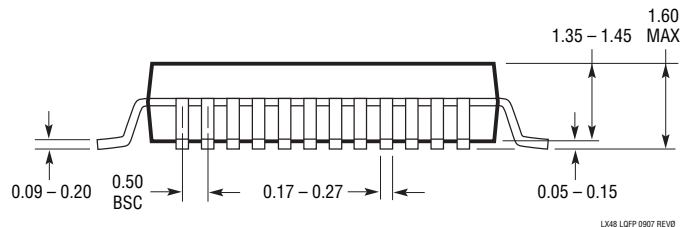
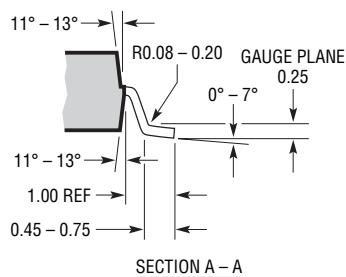

LX48 LQFP 0907 REV0

**NOTE:**

1. PACKAGE DIMENSIONS CONFORM TO JEDEC #MS-026 PACKAGE OUTLINE
2. DIMENSIONS ARE IN MILLIMETERS
3. DIMENSIONS OF PACKAGE DO NOT INCLUDE MOLD FLASH. MOLD FLASH SHALL NOT EXCEED 0.25mm ON ANY SIDE, IF PRESENT

4. PIN-1 IDENTIFIER IS A MOLDED INDENTATION, 0.50mm DIAMETER
5. DRAWING IS NOT TO SCALE

# PACKAGE DESCRIPTION

Please refer to <http://www.linear.com/designtools/packaging/> for the most recent package drawings.

**UK Package**  
**48-Lead Plastic QFN (7mm × 7mm)**  
 (Reference LTC DWG # 05-08-1704)

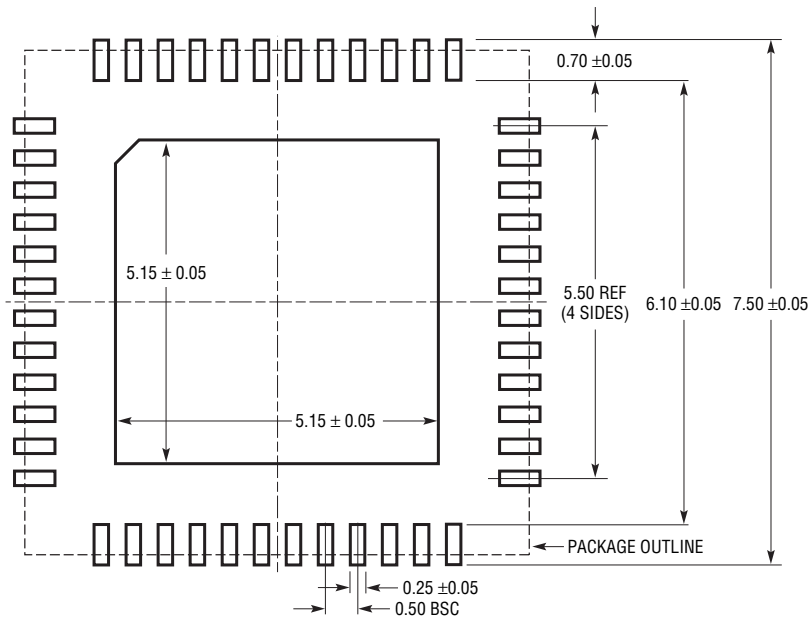

RECOMMENDED SOLDER PAD PITCH AND DIMENSIONS  
 APPLY SOLDER MASK TO AREAS THAT ARE NOT SOLDERED

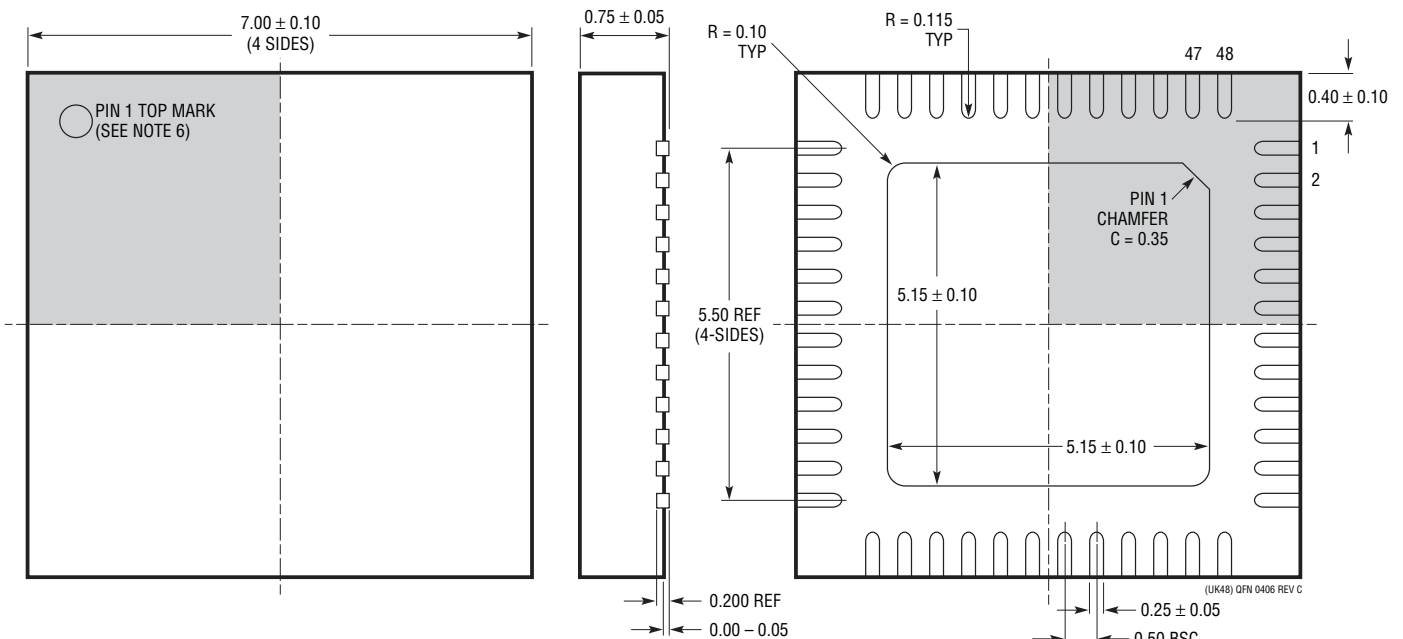

- NOTE:
1. DRAWING CONFORMS TO JEDEC PACKAGE OUTLINE MO-220 VARIATION (WKKD-2)
  2. DRAWING NOT TO SCALE
  3. ALL DIMENSIONS ARE IN MILLIMETERS
  4. DIMENSIONS OF EXPOSED PAD ON BOTTOM OF PACKAGE DO NOT INCLUDE MOLD FLASH. MOLD FLASH, IF PRESENT, SHALL NOT EXCEED 0.20mm ON ANY SIDE, IF PRESENT
  5. EXPOSED PAD SHALL BE SOLDER PLATED
  6. SHADED AREA IS ONLY A REFERENCE FOR PIN 1 LOCATION ON THE TOP AND BOTTOM OF PACKAGE

BOTTOM VIEW—EXPOSED PAD

## TYPICAL APPLICATION

ADC Driver: Single-Ended Input to Differential Output

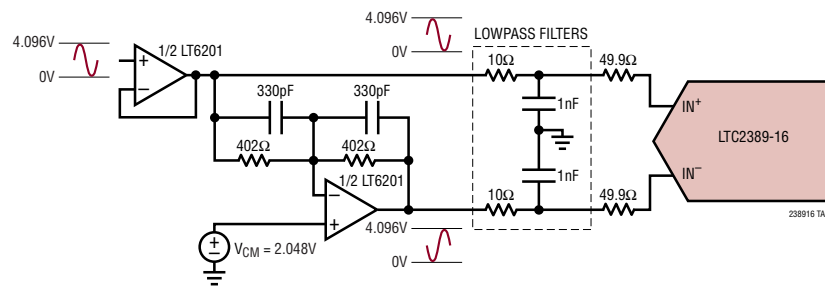

## RELATED PARTS

PART NUMBER	DESCRIPTION	COMMENTS
<b>ADCs</b>		
LTC2389-18	18-Bit, 2.5Msps, All-In-One ADC	5V Supply, Pin-Configurable Input, 99.8dB SNR, $\pm 4.096\text{V}$ , 0V to 4.096V, and $\pm 2.048\text{V}$ Input Ranges, Internal 4.096V Reference, Internal Reference Buffer, 7mm $\times$ 7mm LQFP-48 and QFN-48 Packages
LTC2379-18/LTC2378-18/ LTC2377-18/LTC2376-18	18-Bit, 1.6Msps/1Msps/500ksps/250ksps Serial, Low Power ADC	2.5V Supply, Differential Input, 101.2dB SNR, $\pm 5\text{V}$ Input Range, DGC, Pin-Compatible Family in MSOP-16 and 4mm $\times$ 3mm DFN-16 Packages
LTC2380-16/LTC2378-16/ LTC2377-16/LTC2376-16	16-Bit, 2Msps/1Msps/500ksps/250ksps Serial, Low Power ADC	2.5V Supply, Differential Input, 96.2dB SNR, $\pm 5\text{V}$ Input Range, DGC, Pin-Compatible Family in MSOP-16 and 4mm $\times$ 3mm DFN-16 Packages
LTC2369-18/LTC2368-18/ LTC2367-18/LTC2364-18	18-Bit, 1.6Msps/1Msps/500ksps/250ksps Serial, Low Power ADC	2.5V Supply, Pseudo-Differential Unipolar Input, 96.5dB SNR, 5V Input Range, DGC, Pin-Compatible Family in MSOP-16 and 4mm $\times$ 3mm DFN-16 Packages
LTC2370-16/LTC2368-16/ LTC2367-16/LTC2364-16	16-Bit, 2Msps/1Msps/500ksps/250ksps Serial, Low Power ADC	2.5V Supply, Pseudo-Differential Unipolar Input, 94dB SNR, 5V Input Range, DGC, Pin-Compatible Family in MSOP-16 and 4mm $\times$ 3mm DFN-16 Packages
LTC2393-16/LTC2392-16/ LTC2391-16	16-Bit, 1Msps/500ksps/250ksps Parallel/Serial ADC	5V Supply, Differential Input, 94dB SNR, $\pm 4.096\text{V}$ Input Range, Pin-Compatible Family in 7mm $\times$ 7mm LQFP-48 and QFN-48 Packages
LTC2383-16/LTC2382-16/ LTC2381-16	16-Bit, 1Msps/500ksps/250ksps Serial, Low Power ADC	2.5V Supply, Differential Input, 92dB SNR, $\pm 2.5\text{V}$ Input Range, Pin-Compatible Family in MSOP-16 and 4mm $\times$ 3mm DFN-16 Packages
<b>DACs</b>		
LTC2756/LTC2757	18-Bit, Single Serial/Parallel $I_{OUT}$ SoftSpan™ DAC	$\pm 1\text{LSB}$ INL/DNL, SSOP-28/7mm $\times$ 7mm LQFP-48 Package
LTC2641	16-Bit/14-Bit/12-Bit Single Serial $V_{OUT}$ DACs	$\pm 1\text{LSB}$ INL/DNL, MSOP-8 Package, 0V to 5V Output
LTC2751	16-Bit/14-Bit/12-Bit Single Parallel $I_{OUT}$ SoftSpan DAC	$\pm 1\text{LSB}$ INL/DNL, Software-Selectable Ranges, 5mm $\times$ 7mm QFN-38 Package
<b>References</b>		
LTC6655	Precision Low Drift Low Noise Buffered Reference	5V/2.5V, 5ppm/°C, 0.25ppm Peak-to-Peak Noise, MSOP-8 Package
LTC6652	Precision Low Drift Low Noise Buffered Reference	5V/2.5V, 5ppm/°C, 2.1ppm Peak-to-Peak Noise, MSOP-8 Package
<b>Amplifiers</b>		
LT6200/LT6201	Single/Dual 165MHz Op Amp with Unity Gain Stability	$0.95\text{nV}/\sqrt{\text{Hz}}$ (100kHz), Low Distortion: $-80\text{dB}$ at 1MHz, TSOT23-6 Package
LT6230/LT6231/LT6232	Single/Dual/Quad 215MHz Rail-to-Rail Output Low Noise Low Power Amplifiers	$1.1\text{nV}/\sqrt{\text{Hz}}$ (100kHz), 3.5mA Maximum, 350 $\mu\text{V}$ Maximum Offset
LT6202/LT6203	Single/Dual 100MHz Rail-to-Rail Input/Output Low Noise Low Power Amplifiers	$1.9\text{nV}/\sqrt{\text{Hz}}$ (100kHz), 3mA Maximum, 100MHz Gain Bandwidth
LT6350	Low Noise Single-Ended-to-Differential ADC Driver	Rail-to-Rail Input and Outputs, 240ns 0.01% Settling Time
LTC1992	Low Power, Fully Differential Input/Output Amplifier/Driver Family	1mA Supply Current

238916f



# Mouser Electronics

Authorized Distributor

Click to View Pricing, Inventory, Delivery & Lifecycle Information:

[Analog Devices Inc.:](#)

[LTC2389CLX-16#PBF](#) [LTC2389IUK-16#PBF](#) [LTC2389ILX-16#PBF](#) [LTC2389CUK-16#TRPBF](#) [LTC2389CUK-16#PBF](#) [LTC2389HLX-16#PBF](#) [LTC2389IUK-16#TRPBF](#)