

FEATURES

- Carbon resistive element.
- IP54 protection according to IEC 60529.
- Polyester substrate.
- Also upon request:
 - Long life model for low cost control pot. applications
 - Low torque option
 - Supplied in magazines for automatic insertion.
 - Wiper positioned at initial, 50% or fully clockwise.
 - Self extinguishable plastic UL 94V-0.
 - Cut track option.
 - Special Tapers.
 - Mechanical detents.

MECHANICAL SPECIFICATIONS

- Mechanical rotation angle: $265^\circ \pm 5^\circ$
 $240^\circ \pm 5^\circ$ available under drawing (blue housing only)
- Electrical rotation angle: $240^\circ \pm 20^\circ$
- Torque: 0.5 to 2.5 Ncm.
(0.7 to 3.4 in-oz)
- Stop torque: > 10 Ncm. (>14 in-oz)
- Life*: Up to 100K cycles

ELECTRICAL SPECIFICATIONS

- Range of values*: $100\Omega \leq R_n \leq 5M\Omega$ (Decad. 1.0 - 2.0 - 2.2 - 2.5 -4.7 -5.0)
- Tolerance*: $100\Omega \leq R_n \leq 1M\Omega$: $\pm 20\%$
 $1M\Omega \leq R_n \leq 5M\Omega$: $\pm 30\%$
- Max. Voltage: 250 VDC (lin) 125 VDC (no lin)
- Nominal Power 50°C (122°F) (see power rating curve)
0.25 W (lin) 0.12 W (no lin)
- Taper*: (Log. & Alog. only $R_n \geq 1K$) Lin ; Log; Alog.
- Residual resistance*: $\leq 0.5\% R_n$ (5Ω min.)
- Equivalent Noise Resistance: $\leq 3\% R_n$ (3Ω min.)
- Operating temperature**: $-25^\circ C + 70^\circ C$ ($-13^\circ F + 158^\circ F$)

* Others: check

** Up to 85°C depending on application.

HOW TO ORDER

PT15	L	H01	-	223	A	2020	OPTIONAL EXTRAS				S
Series	Code	Mounting Method		Taper	Life	Detents	Flammability	Wiper position	Shaft/rotor colour	Magazine	
Rotors	H01 H2.5 H05 H5 H25 HC5 H06 B H02 H2.5P H10 H5P V02 V12.5 V12 VA V15 V15 V17 V17.5 V18 D V24 VD15 V21 V12.5P V22 VAP V23 V15P V25 V17.5P			A = Lin. B = Log. C = Alog.	E = Long life U = Extra Long life (See note 5)	PAI PAM PAF P11 P1F P02 : P38	I = non flammable (See note 6)	PM = 50% PF = Final	RO=Red NE=Black VE=Green AM=Yellow AZ=Blue MA=Brown GR=Grey NA=Orange CR=Cream (See note 7)	T (See note 9)	
(See note 1)	(See note 2)			Value	Tolerance	Cut track	Shaft/Thum.	Torque			
				101 = 100 Ω 223 = 22 K 504 = 500 K 505 = 5 M (See note 3)	0505 = ± 5% 0707 = ± 7% 1010 = ± 10% 2020 = ± 20% 3030 = ± 30% (See note 4)	PCI = Initial PCF = Final	01 - Fig. 1 : 28 - Fig. 28 (See note 10)	-- Standard L = Low torque (See note 8)			

NOTES:

- "Z" adjustment only available on "H" versions. Standard colour for the "T" rotor: Orange.
- Terminal styles: "P" are crimped terminals. V24 terminals material: brass. V=Vertical adjust; H=Horizontal Adjust
- Value: Example: Code: $\frac{10}{1} \rightarrow 100 \Omega$ Example: $\frac{07}{05} \rightarrow$ negative tolerance positive tolerance
 Numb. of zeros. First two digits of the value.
- Non standard tolerance: check availability.
- Life
 - Standard: 1K cycles.
 - Long life: 10K cycles.
 - Extra long life: 100K cycles (Only for low torque versions. To be studied case by case.)
- Non flammable: housing, rotor and shaft. According to UL 94V-0
- Colour shaft/rotor:
 - Potentiometer without shaft: only rotor
 - Potentiometer with shaft: only shaft
 - Cream colour only available in standard plastic.
- Low torque: $\leq 1.5Ncm$. No detent option available for low torque models.
- Magazines (35 pcs/mag): available for VA (12.5), V (12.5), V (12.5P), V (15), V15 (P) and H models. For more information please contact your nearest Piher supplier.
- If you wish to use your own custom plastic shaft/knob/actuator please contact Piher for advice about compatible materials.

HOW TO ORDER CUSTOM DRAWING

PT-15 LH 01 + DRAWING NUMBER (Max. 16 digits)

This way of ordering should be used for options which are not included in the "How to order" standard and optional extras.

STANDARD OPTIONS

Cut track	No
Detents	None
Non flammable	No
Rotor colour	White
Shaft colour	Natural
Wiper position	Initial
Torque	Standard
Terminals material	Steel
Life	1000 cycles

ROTORS

Wipers positioned at initial (without shaft)

Wipers positioned at 50% (without shaft)

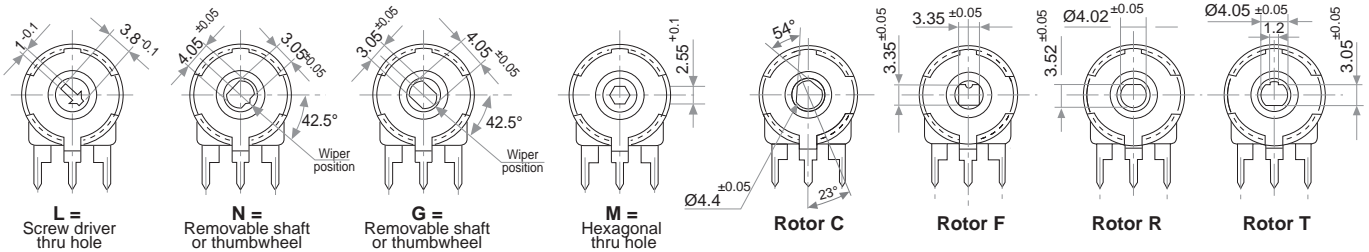

With shaft

With thumbwheel

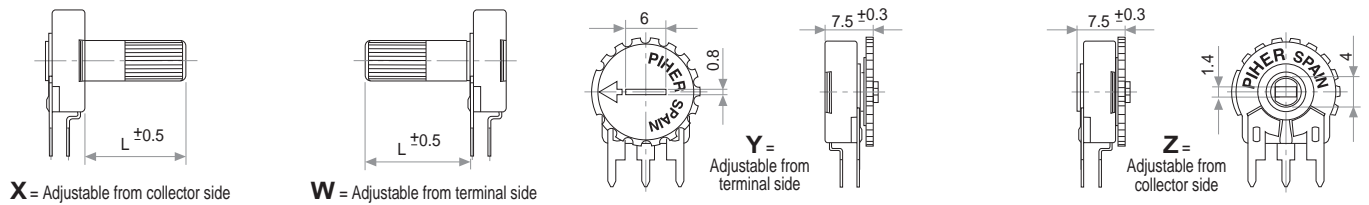

VERTICAL MOUNT - HORIZONTAL ADJUST

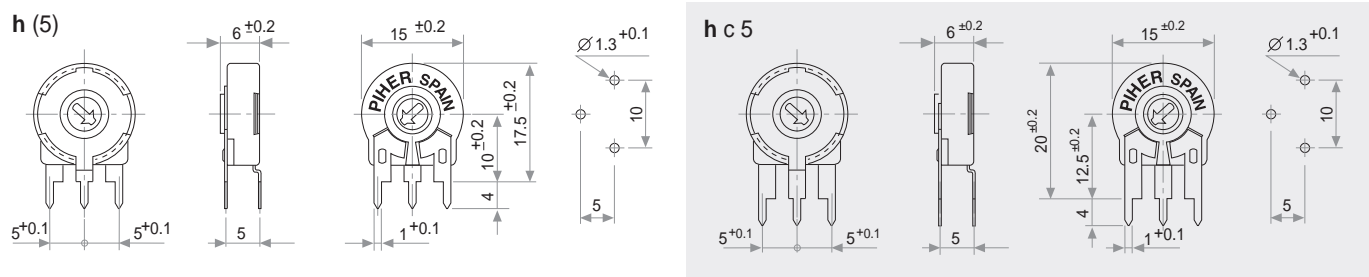
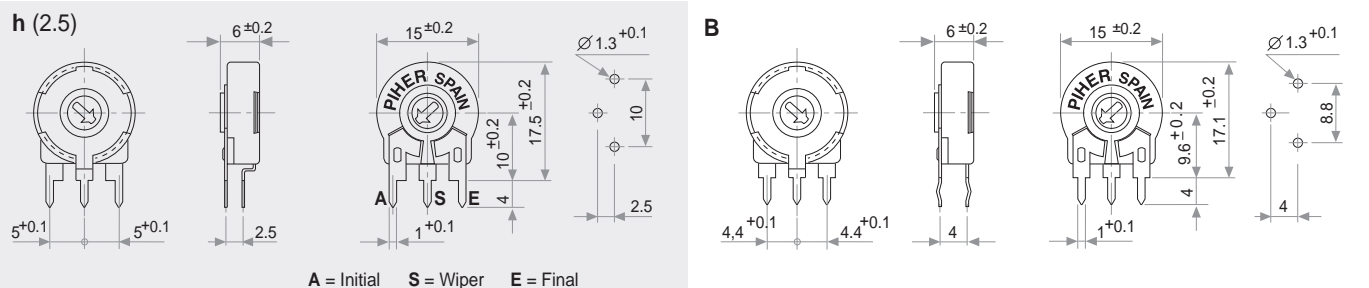

Check availability.

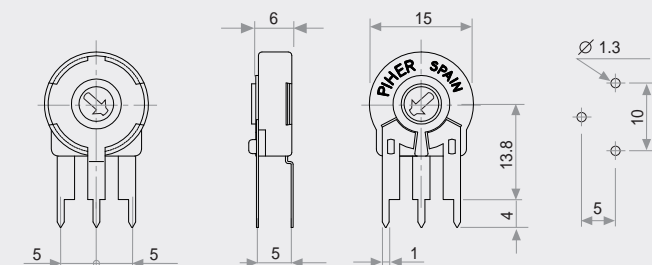

HORIZONTAL MOUNT - VERTICAL ADJUST

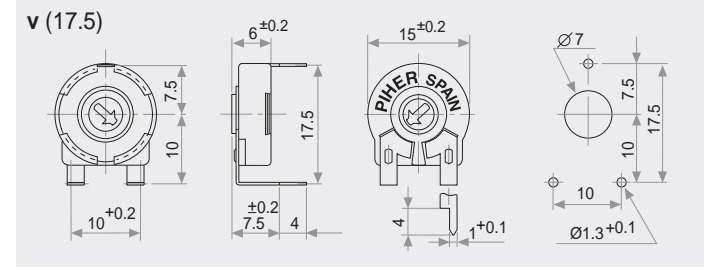
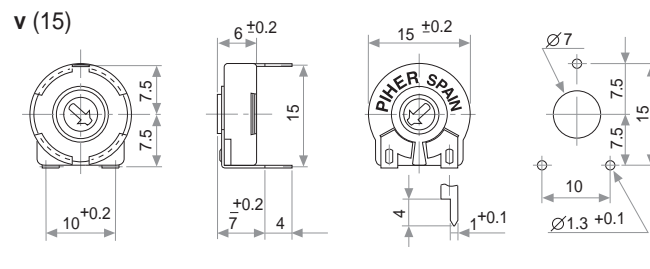
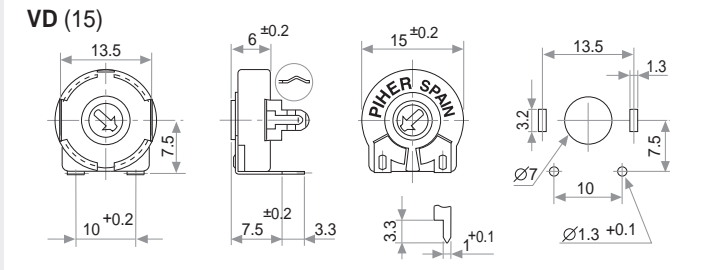
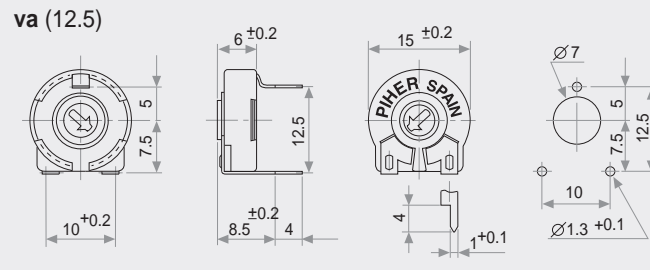
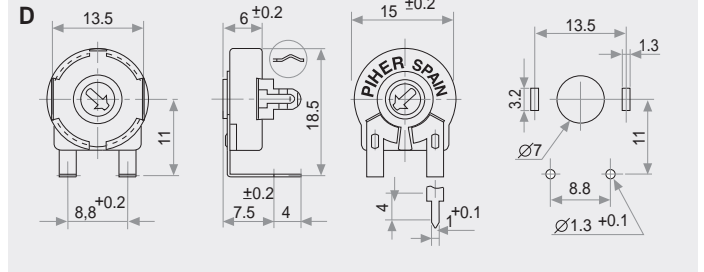
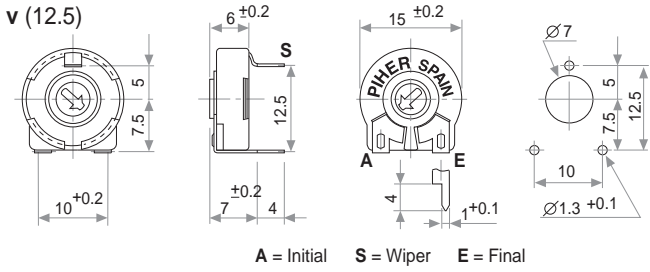

Check availability.

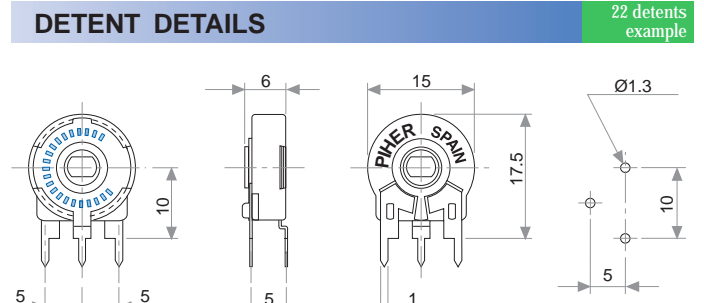
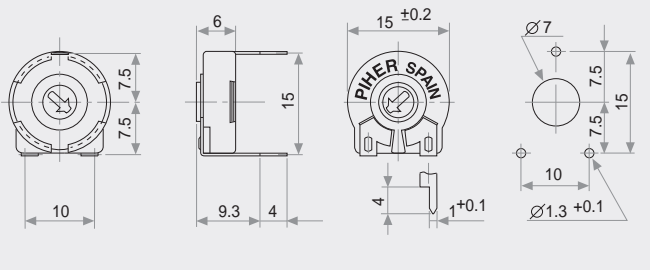

CRIMPED TERMINALS (DETAIL)

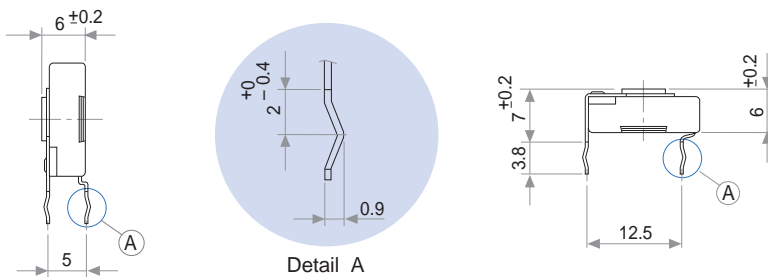

POWER RATING CURVE

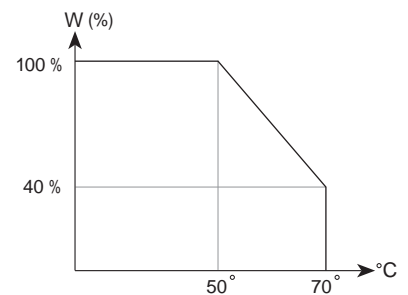

TAPERS

- A = Linear
- B = Log.
- C = Alog.

NOTE: Please note terminals disposition when ordering non linear curves.

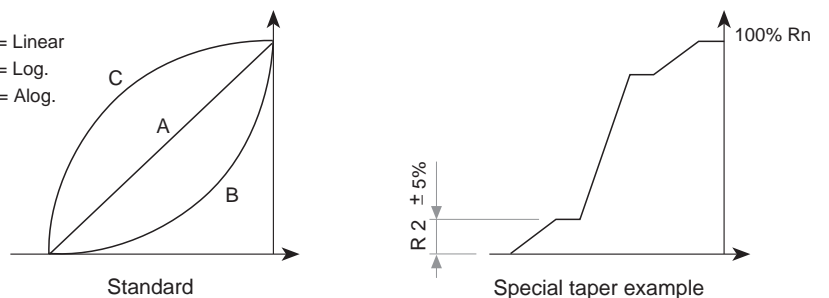

OPTIONS

Positioning

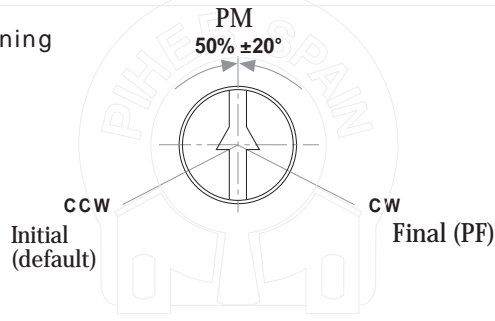

Cut Track
(open circuit zone)

CCW on-off (A)

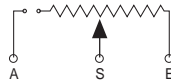

A = Initial
S = Wiper
E = Final

CW on-off (E)

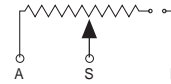

TESTS

VARIATIONS

ELECTRICAL LIFE	1.000 h. @ 50°C; 0.25 W	±5 %
MECHANICAL LIFE (CYCLES)	1000 @ 10 CPM ... 15 CPM	±3 % (Rn < 1 MΩ)
TEMPERATURE COEFFICIENT	-25°C; +70°C	±300 ppm (Rn < 100 K)
THERMAL CYCLING	16 h. @ 85°C; 2h. @ -25°C	±2.5 %
DAMP HEAT	500 h. @ 40°C @ 95% HR	±5 %
VIBRATION (for each plane X,Y,Z)	2 h. @ 10 Hz. ... 55 Hz.	±2 %

NOTE: Out of range values may not comply these results.

SHAFTS (for N, G and T rotor types, top view)

Hollow model shafts

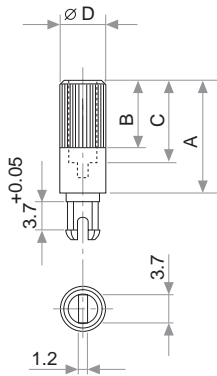

FIG.	A	B	C	D	Ref.
1	12	9	8	6	5272
2	19	9	15	6	5214
5	9.5	6.5	5.5	6	5208
9	35	9	31	6	5216
10	37.8	9	33.8	6	5218
11	35	25	15	6	5209
13	7.8	4.8	3.8	6	5265

A = Length (FRS)
B = Knurling length
C = Hollow depth
D = Shaft diameter
FRS = From rotor surface

Solid model shafts

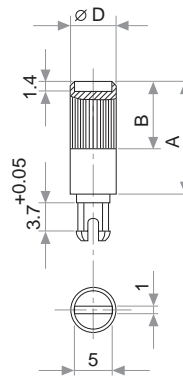
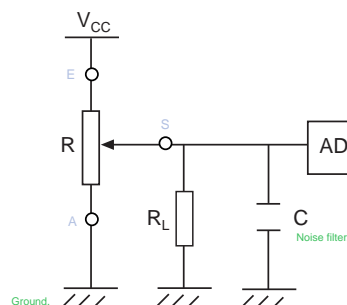

FIG.	A	B	D	Ref.
6	15	9	6	5219
7	16.8	9	6	5220
8	25.3	9	6	5207
12	46	5	6	5227

Slot (1 x 1.4) perpendicular to wiper position. Fig. 12 slot is on line with wiper position.

RECOMMENDED CONNECTIONS

Piher potentiometer's recommended connection circuit for a position sensor or control application. (voltage divider circuit electronic design).



$$R_L \geq 100 \times R$$

SHAFTS (for N, G and T rotor types, top view)

By default shafts, knobs & thumbwheels are delivered unassembled.

Mounted shafts, knobs & thumbwheels are delivered at random position. Positioning available check availability.

If you wish to use your own plastic shaft/knob/actuator please contact Piher for advice about compatible materials.

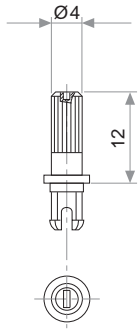

Fig. 3 / Ref. 5372

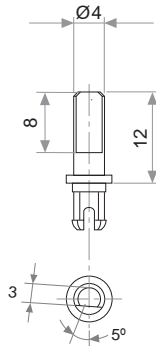

Fig. 15 / Ref. 5217

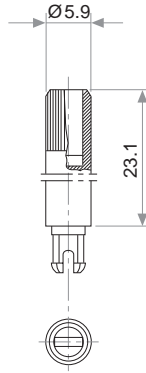

Fig. 17 / Ref. 5210

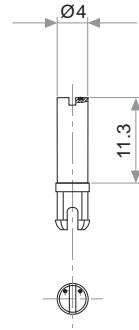

Fig. 18 / Ref. 5271

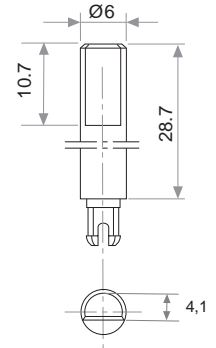

Fig. 19 / Ref. 6032*

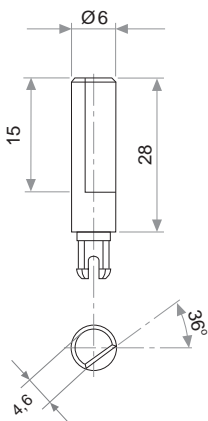

Fig. 20 / Ref. 5369*

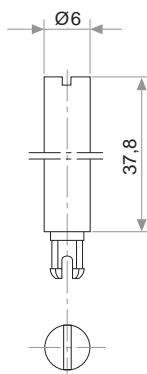

Fig. 21 / Ref. 6031*

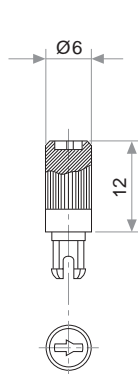

Fig. 22 / Ref. 6029

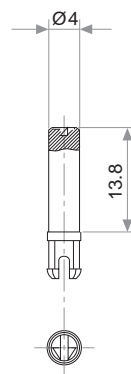

Fig. 23 / Ref. 6022

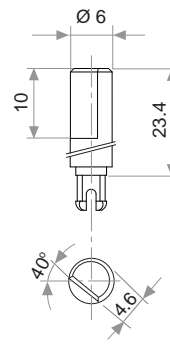

Fig. 29 / Ref. 6162

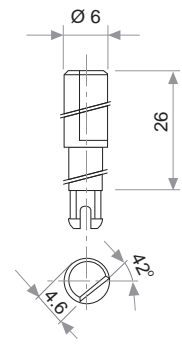

Fig. 25 / Ref. 6059

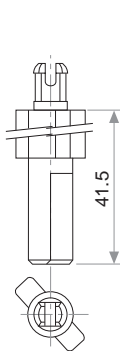

Fig. 27 / Ref. 5268*

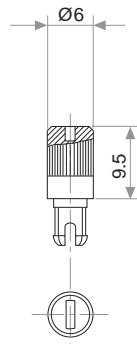

Fig. 28 / Ref. 6055

* Not available in self extinguishable plastic

THUMBWHEEL

By default shafts, knobs & thumbwheels are delivered unassembled.

Mounted shafts, knobs & thumbwheels are delivered at random position. Positioning available check availability.

If you wish to use your own plastic shaft/knob/actuator please contact Piher for advice about compatible materials.

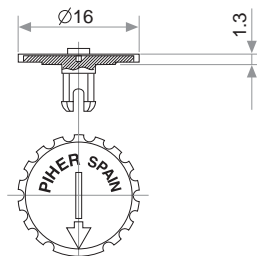

Fig. 4 / Ref. 5371

DETENT CONFIGURATIONS EXAMPLES

This innovative PT's with detents family has been specifically developed to allow the integration of otherwise large and expensive external mechanisms into the body of the potentiometer thus allowing a high range of configurations: special tapers, torque, tolerances, linearity, cut track, etc.

This detent (stop position) design not only adds a "click" sensation of position, but also offers enormous savings in both cost and space for any given application.

Strong and weak detents can be mixed as per customer's request.

Detent number and positions can be made or fitted to the customer needs or preferences.

- ▬ Relative detent positions along the total mechanical travel. Unless otherwise specified the detents are evenly spaced (using the end points as reference)

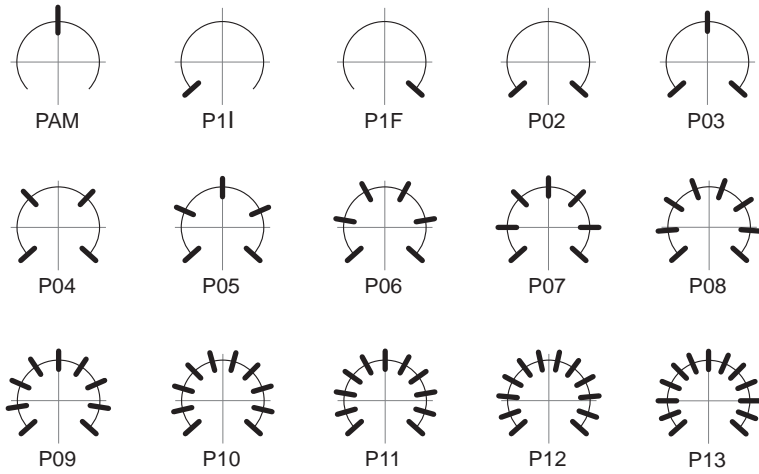

A = 32.625°
B = 34.5°

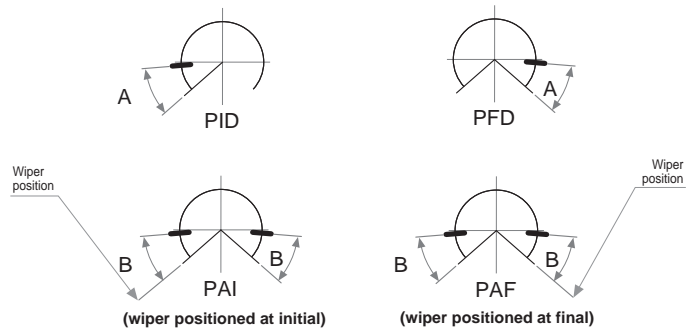

NOTES FOR DETENTED VERSIONS:

- (1) For the following mounting methods, the detents configurations will be studied individually case by case:
 - V02 & V21
 - V12 & V22
 - V18
 - V24
- (2) For more than 13 detents versions please contact your nearest PIHER authorised distributor.
- (3) Standard mechanical life is 500 cycles.
- (4) Long life versions are available under request and have the following characteristics at T^a:
 - Potentiometers with 1 to 3 detents: up to 10K cycles
 - Potentiometers with 4 and more detents: up to 5K cycles
- (5) Detent torque can vary from 1.2 to 2.5 times the standard potentiometer torque.

For all detents versions of more than 13 detents the detent torque will be 0.5 to 3.5 Ncm.
- (6) Please consult your nearest Piher supplier if unique non-overlapping values at each detent position or LOG/ALOG tapers are required.
- (7) Different output voltage values can be matched at each detent position (under request).

DETENTS WITH CONSTANT VALUE ZONES

application notes

PIHER's potentiometers may feature special stepped outputs or 'constant voltage zones' for the 6, 10 and 15mm product families.

These constant voltage zones can be combined with PIHER's mechanical detents to provide exact alignment between the electrical output (flat areas) and the mechanical detent's positions. The result is a higher level of precision in controlling lighting, temperature, motor or other electronic control systems.

In addition to established catalogue detent configurations, we will design and manufacture any other configuration on our tried-and-tested carbon/cermet & THM/SMD potentiometer technology and processes.

With its exacting control capabilities, our 10mm and 15mm potentiometers series are well suited for many consumer applications such as ovens, ranges, dishwashers, lighting (dimmers), power hand tools, washing machines and HVAC systems.

Constant value zones can be combined with strategically located stops matching the flat areas of the output.

10 stepped outputs version example:

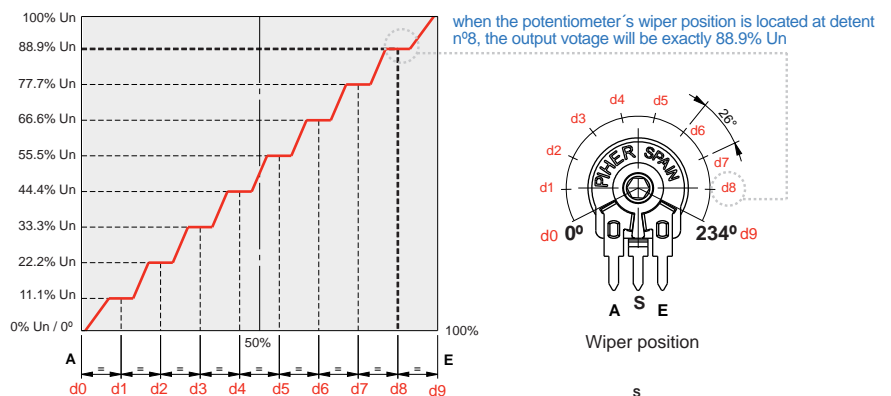

Improved repeatability

By combining the constant value zones with the detents, engineers can align the same voltage values with each of the detent stops when rotating the control both forward and backward.

This provides clear mechanical positions that are not only repeatable, but perfectly aligned electrical outputs at each of the (detent) angles.

Piher’s detents also prevent output values from changing due to vibration or accidental rotor movements, furthering reliable control consistency.

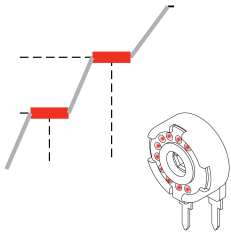

Design tip. Cost-effectiveness

Absolute encoders can easily be replaced connecting the potentiometer to the microprocessor’s analogue input.



Main advantages

- ✓ Unique, non-overlapping values at each stop (detent position)
- ✓ Prevents output value change due to light vibration or accidental rotor micro-movements
- ✓ Fully customisable according to customer’s needs
- ✓ Cost effective replacement for absolute encoders

Disclaimer

The product information in this catalogue is for reference purposes. Please consult for the most up to date and accurate design information.

Piher Sensors & Controls S.A., its affiliates, agents, and employees, and all persons acting on its or their behalf (collectively, “Piher”), disclaim any and all liability for any errors, inaccuracies or incompleteness contained herein or in any other disclosure relating to any product described herein.

Piher disclaims any and all liability arising out of the use or application of any product described herein or of any information provided herein to the maximum extent permitted by law. The product specifications do not expand or otherwise modify Piher’s terms and conditions of sale, including but not limited to the warranty expressed therein, which apply to these products.

No licence, express or implied, by estoppel or otherwise, to any intellectual property rights is granted by this document or by any conduct of Piher.

The products shown herein are not designed for use in medical, life-saving, or life-sustaining applications unless otherwise expressly indicated. Customers using or selling Piher products not expressly indicated for use in such applications do so entirely at their own risk and agree to fully indemnify Piher for any damages arising or resulting from such use or sale. Please contact authorised Piher personnel to obtain written terms and conditions regarding products designed for such applications.

Product names and markings noted herein may be trademarks of their respective owners.

Information contained in and/or attached to this catalogue may be subject to export control regulations of the European Community, USA, or other countries. Each recipient of this document is responsible to ensure that usage and/or transfer of any information contained in this document complies with all relevant export control regulations. If you are in any doubt about the export control restrictions that apply to this information, please contact the sender immediately. For any Piher Exports, Note: All products / technologies are EAR99 Classified commodities. Exports from the United States are in accordance with the Export Administration Regulations. Diversion contrary to US law is prohibited.

Piher is an Amphenol™ company.



3D models in our web

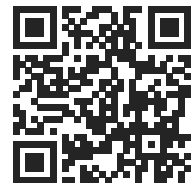

Note: All Piher products can be adapted to meet customer’s requirements. Due to continuous process improvement, specifications are subject to change without notice. Please always use the latest updated datasheets and 3D models published at our website www.piher.net.