

### FEATURES

- Normally Open, Single Pole Single Throw Operation
- Control 350 VAC or DC Voltage
- Switch 100 mA Loads
- LED Control Current, 1.5 mA
- Low ON-Resistance
- $dv/dt$ , >500 V/ms
- Isolation Test Voltage, 3750 VAC<sub>RMS</sub>
- Current Limiting
- Underwriters Lab File # E52744

### APPLICATIONS

- Telephone Switch Hook
- High Voltage Test Equipment
- TRIAC Driver
- Motor Control
- Industrial Control Systems

### DESCRIPTION

The LH1056 is a single pole single throw (SPST), normally open (NO), solid state relay. The relay can control AC or DC loads currents up to 100 mA, with a supply voltage up to 350 V. The device is packaged in a six pin 0.3 inch dual-in line package. This package offers an insulation dielectric withstand of 7500 VAC<sub>PK</sub>.

The coupler consists of a AlGaAs LED that is optically coupled to a dielectrically isolated photodiode array which drives two series connected high voltage MOS transistors. The typical ON-Resistance is 30  $\Omega$  at 25 mA and is linear up to 50 mA. The incremental resistance drops to less than 20  $\Omega$  beyond 50 mA while reducing internal power dissipation at high load currents. There is built-in current limiting circuitry in the detector chip.

Package Dimensions in Inches (mm)

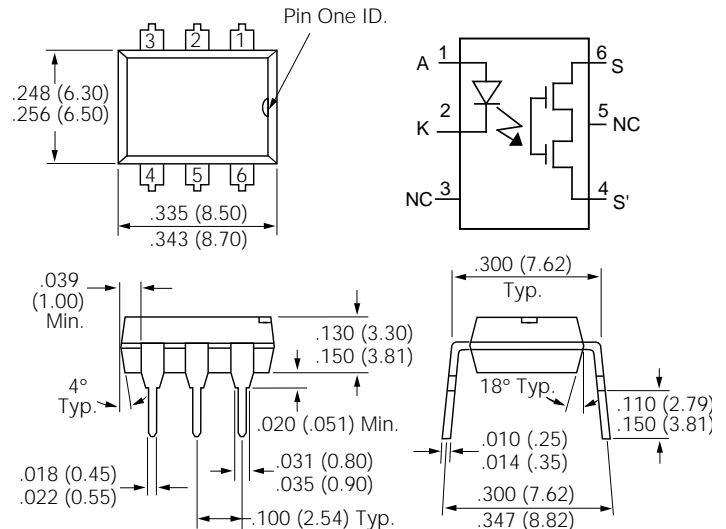

### Absolute Maximum Ratings (T<sub>A</sub>=25°C)

#### Emitter

Reverse Voltage.....	6.0 V
Continuous Forward Current.....	60 mA
Peak Forward Current (1 $\mu$ s).....	1 A
Power Dissipation.....	100 mW
Derate Linearly from 25°C.....	1.3 mW/°C

#### Detector

Output Breakdown Voltage.....	$\pm 350$ V
Continuous Load Current.....	$\pm 100$ mA
Total Power Dissipation.....	500 mW
Derate Linearly from 25°C.....	See Figure 7

#### Package

Isolation Test Voltage.....	3750 VAC <sub>RMS</sub>
Isolation Resistance	
V <sub>IO</sub> =500 V, T <sub>A</sub> =25°C.....	$\geq 10^{12}$ $\Omega$
V <sub>IO</sub> =500 V, T <sub>A</sub> =100°C.....	$\geq 10^{11}$ $\Omega$
Power Dissipation.....	500 mW
Derate Linearly from 25°C.....	2.5 mW/°C
Storage Temperature Range.....	-40 to +150°C
Operating Temperature Range.....	-40 to +85°C
Junction Temperature.....	100°C
Soldering Temperature, 2 mm from case, 10 sec.....	260°C

**Characteristics** ( $T_A=25^\circ\text{C}$ )

Description	Symbol	Min.	Typ.	Max.	Unit	Test Condition
<b>Emitter</b>						
Forward Voltage	$V_F$		1.25	1.5	V	$I_F=10\text{ mA}$
$V_F$ Temperature Coefficient	$\Delta V_F/\Delta T$		-2.2		mV/°C	
Reverse Current	$I_R$		1	10	$\mu\text{A}$	$V_R=6\text{ V}$
Junction Capacitance	$C_J$		15		pF	$V_F=0\text{ V}$ , $f=1\text{ MHz}$
Dynamic Resistance	$\Delta V_F/\Delta I_F$		6		$\Omega$	$I_F=10\text{ mA}$
Switching Time	$t_R$ , $t_F$		1		$\mu\text{s}$	$I_F=10\text{ mA}$
<b>Detector</b>						
Output Breakdown Voltage	$V_B$	350	380		V	$I_B=50\text{ }\mu\text{A}$
Output Off-State Leakage Current	$I_{T(\text{OFF})}$		.03	200	nA	$V_T=100\text{ V}$ , $I_F=0\text{ mA}$
Feed through Capacitance, pins 4 to 6	$C_T$		24		pF	$I_F=0$ , $f=1\text{ KHz}$ , $V_L=4\text{ VP-P}$
Current Limit	$I_{\text{LMT}}$	100	150	210	mA	$I_F=5\text{ mA}$ , $V_L=\pm 7\text{ V}$ , $t=10\text{ ms}$
<b>Package</b>						
LED Forward Current for Turn-on	$I_{\text{FON}}$		2.5	3.5	mA	$V_L=\pm 7\text{ V}$ , $I_L=100\text{ mA}$ , $t=10\text{ ms}$
LED Forward Current for Turn-off	$I_{\text{FOFF}}$	0.2		1.3	mA	$V_L=\pm 300\text{ V}$ , $I_F<5\text{ }\mu\text{A}$
ON Resistance	$R_{\text{ON}}$	20	30	50	$\Omega$	$I_T=\pm 25\text{ mA}$ , $I_F=5\text{ mA}$
Turn-on Time	$t_{\text{ON}}$		0.9	2.0	ms	$I_F=10\text{ mA}$ , $V_L=+50\text{ V}$ $R_L=1\text{ k}\Omega$
Turn-off Time	$t_{\text{OFF}}$		0.7	2.0	ms	

**Figure 1. Timing test circuit**

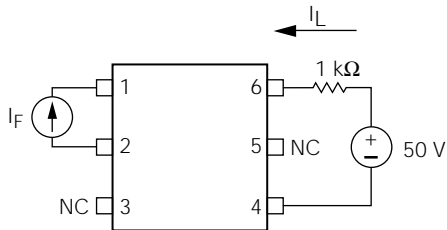

**Figure 2. LED forward current vs. forward voltage**

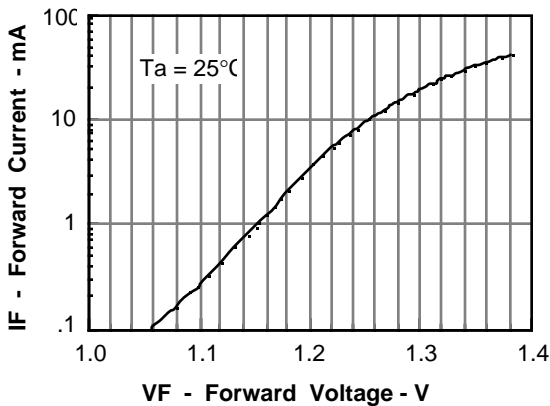

**Figure 3. Timing waveform**

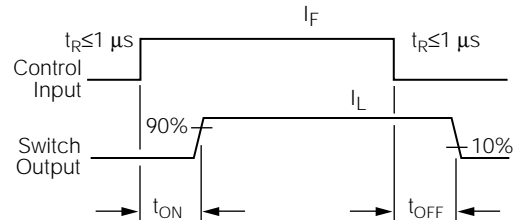

**Figure 4. Terminal current vs. terminal voltage**

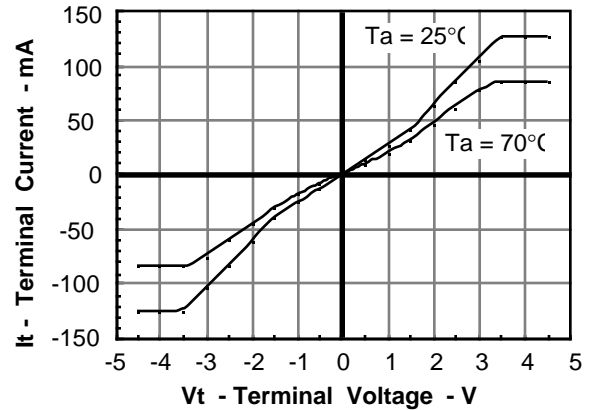

Figure 5. Turn on current vs. temperature

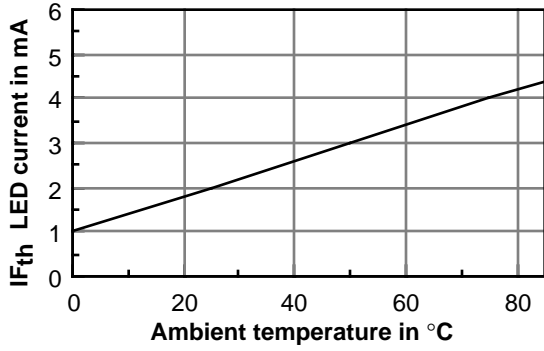

Figure 9.  $\Delta R_{on}$  vs. temperature

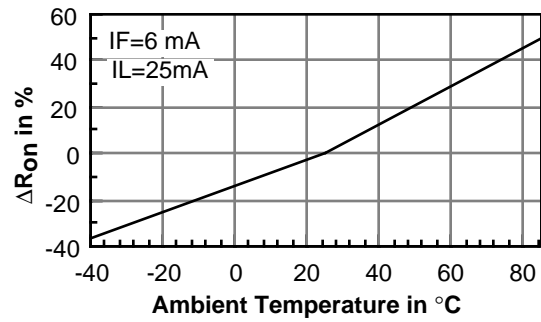

Figure 6. Load current vs. temperature

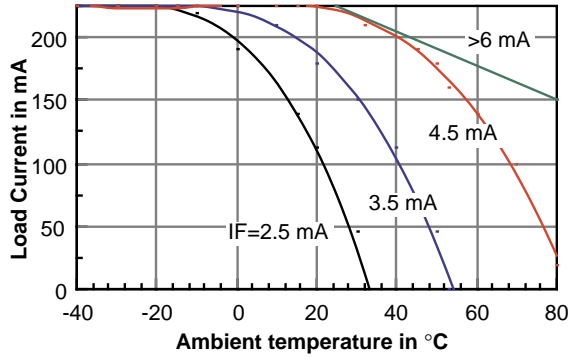

Figure 10.  $\Delta T_{off}$  vs. temperature

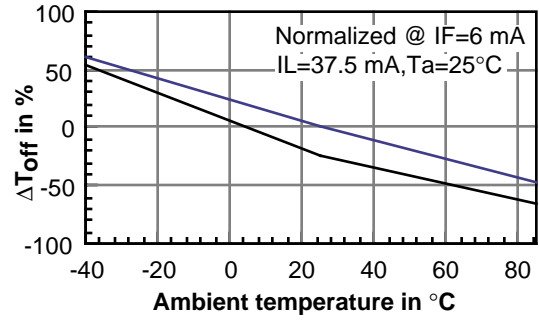

Figure 7. Derating of ILoad vs. temperature

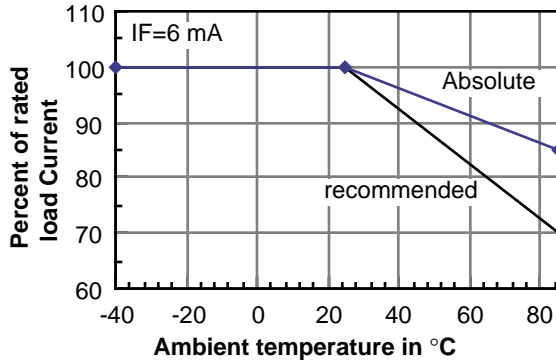

Figure 11. Change in Ton vs. temperature

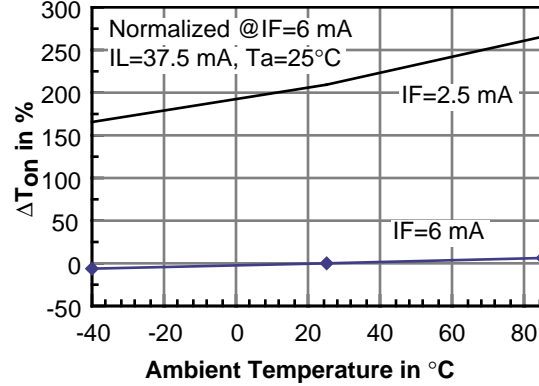

Figure 8. Change in I<sub>limit</sub> vs. temperature

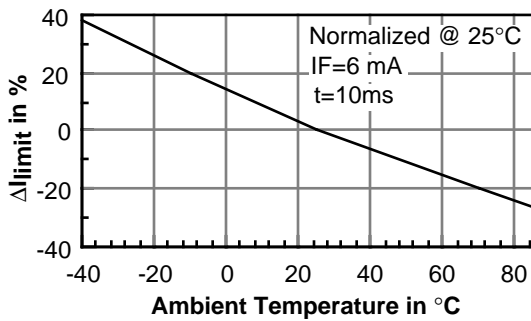
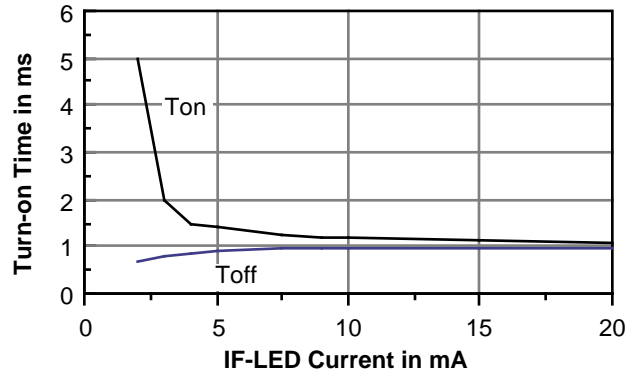

Figure 12. Turn-on and turn-off time vs. LED current



This datasheet has been download from:

[www.datasheetcatalog.com](http://www.datasheetcatalog.com)

Datasheets for electronics components.