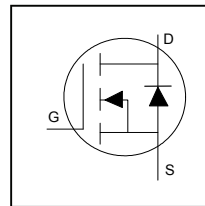


HEXFET® Power MOSFET

**Application**

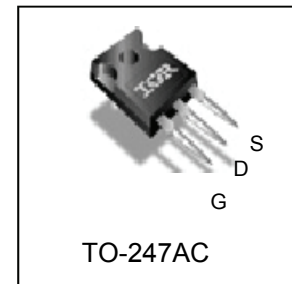
- High Efficiency Synchronous Rectification in SMPS
- Uninterruptible Power Supply
- High Speed Power Switching
- Hard Switched and High Frequency Circuits



<b>V<sub>DSS</sub></b>	<b>200V</b>
<b>R<sub>DS(on)</sub> typ.</b>	<b>17mΩ</b>
	<b>max</b>
<b>I<sub>D</sub></b>	<b>75A</b>

**Benefits**

- Improved Gate, Avalanche and Dynamic dV/dt Ruggedness
- Fully Characterized Capacitance and Avalanche SOA
- Enhanced body diode dV/dt and dI/dt Capability
- Lead-Free, RoHS Compliant



<b>G</b>	<b>D</b>	<b>S</b>
Gate	Drain	Source

Base part number	Package Type	Standard Pack		Orderable Part Number
		Form	Quantity	
IRFP4127PbF	TO-247AC	Tube	25	IRFP4127PbF

	Parameter	Max.	Units
I <sub>D</sub> @ T <sub>C</sub> = 25°C	Continuous Drain Current, V <sub>GS</sub> @ 10V	75	A
I <sub>D</sub> @ T <sub>C</sub> = 100°C	Continuous Drain Current, V <sub>GS</sub> @ 10V	53	
I <sub>DM</sub>	Pulsed Drain Current ①	300	
P <sub>D</sub> @ T <sub>C</sub> = 25°C	Maximum Power Dissipation	341	W
	Linear Derating Factor	2.3	W/°C
V <sub>GS</sub>	Gate-to-Source Voltage	± 20	V
dv/dt	Peak Diode Recovery dv/dt③	57	V/ns
T <sub>J</sub> T <sub>STG</sub>	Operating Junction and Storage Temperature Range	-55 to + 175	°C
	Soldering Temperature, for 10 seconds (1.6mm from case)	300	
	Mounting Torque, 6-32 or M3 Screw	10 lbf·in (1.1 N·m)	

**Avalanche Characteristics**

E <sub>AS</sub> (Thermally limited)	Single Pulse Avalanche Energy ②	244	mJ
-------------------------------------	---------------------------------	-----	----

**Thermal Resistance**

	Parameter	Typ.	Max.	Units
R <sub>θJC</sub>	Junction-to-Case ④	—	0.4	°C/W
R <sub>θCS</sub>	Case-to-Sink, Flat Greased Surface	0.24	—	
R <sub>θJA</sub>	Junction-to-Ambient ⑦⑧	—	40	

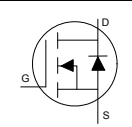
**Static @ T<sub>J</sub> = 25°C (unless otherwise specified)**

	Parameter	Min.	Typ.	Max.	Units	Conditions
V <sub>(BR)DSS</sub>	Drain-to-Source Breakdown Voltage	200	—	—	V	V <sub>GS</sub> = 0V, I <sub>D</sub> = 250μA
ΔV <sub>(BR)DSS</sub> /ΔT <sub>J</sub>	Breakdown Voltage Temp. Coefficient	—	0.23	—	V/°C	Reference to 25°C, I <sub>D</sub> = 5mA
R <sub>DS(on)</sub>	Static Drain-to-Source On-Resistance	—	17	21	mΩ	V <sub>GS</sub> = 10V, I <sub>D</sub> = 44A ④
V <sub>GS(th)</sub>	Gate Threshold Voltage	3.0	—	5.0	V	V <sub>DS</sub> = V <sub>GS</sub> , I <sub>D</sub> = 250μA
I <sub>DSS</sub>	Drain-to-Source Leakage Current	—	—	20	μA	V <sub>DS</sub> = 200 V, V <sub>GS</sub> = 0V
		—	—	250		V <sub>DS</sub> = 200V, V <sub>GS</sub> = 0V, T <sub>J</sub> = 125°C
I <sub>GSS</sub>	Gate-to-Source Forward Leakage	—	—	100	nA	V <sub>GS</sub> = 20V
	Gate-to-Source Reverse Leakage	—	—	-100		V <sub>GS</sub> = -20V
R <sub>G</sub>	Gate Resistance	—	3.0	—	Ω	

**Dynamic Electrical Characteristics @ T<sub>J</sub> = 25°C (unless otherwise specified)**

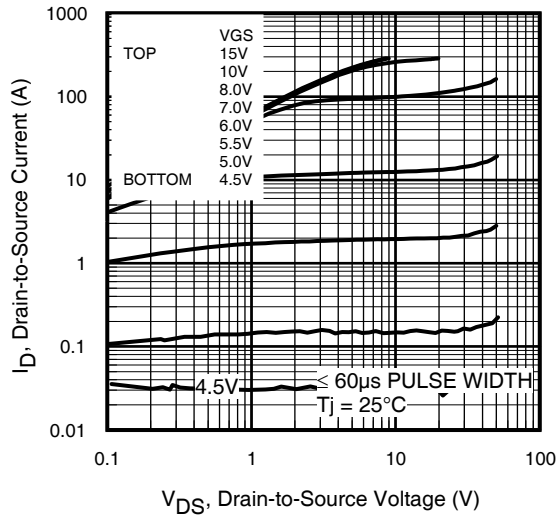
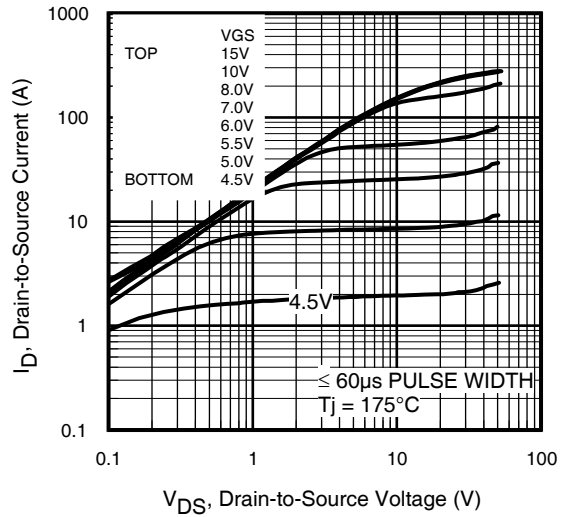
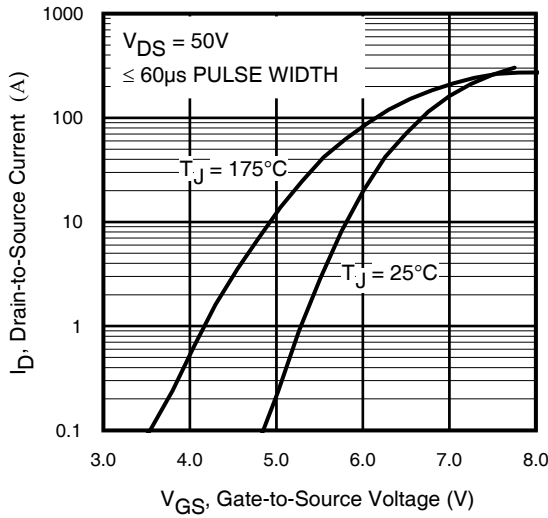
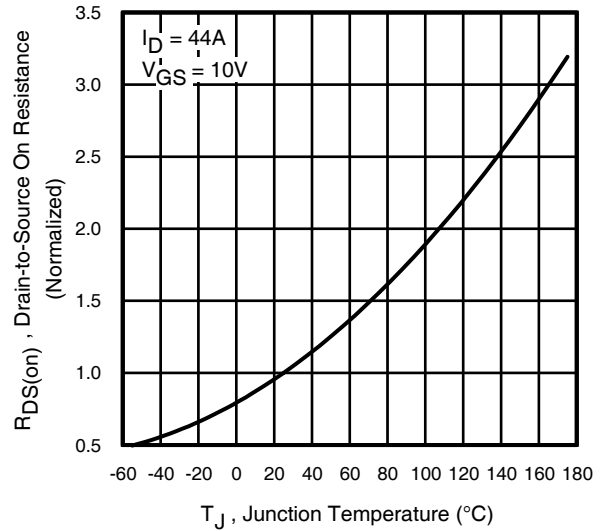
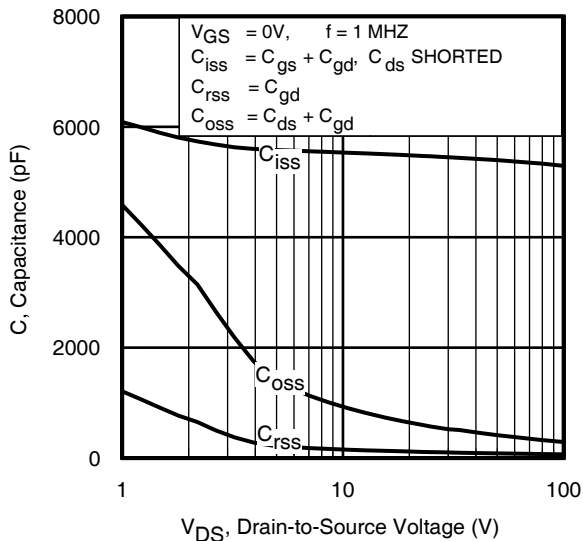
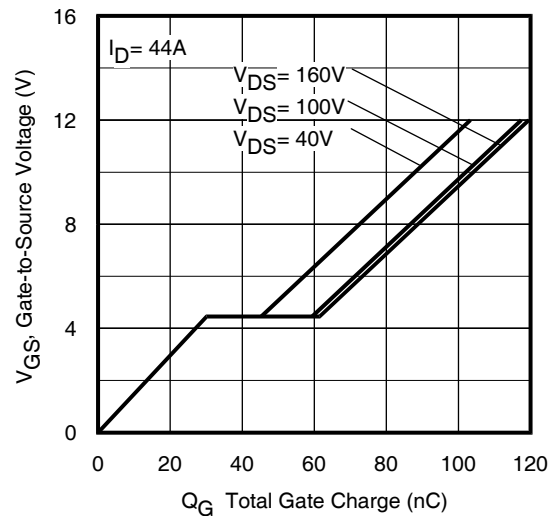
g <sub>fs</sub>	Forward Transconductance	45	—	—	S	V <sub>DS</sub> = 50V, I <sub>D</sub> = 44A
Q <sub>g</sub>	Total Gate Charge	—	100	150	nC	I <sub>D</sub> = 44A
Q <sub>gs</sub>	Gate-to-Source Charge	—	30	—		V <sub>DS</sub> = 100V
Q <sub>gd</sub>	Gate-to-Drain Charge	—	31	—		V <sub>GS</sub> = 10V
Q <sub>sync</sub>	Total Gate Charge Sync. (Q <sub>g</sub> - Q <sub>gd</sub> )	—	69	—		I <sub>D</sub> = 44A, V <sub>DS</sub> = 0V, V <sub>GS</sub> = 10V
t <sub>d(on)</sub>	Turn-On Delay Time	—	17	—	ns	V <sub>DD</sub> = 100V
t <sub>r</sub>	Rise Time	—	18	—		I <sub>D</sub> = 44A
t <sub>d(off)</sub>	Turn-Off Delay Time	—	56	—		R <sub>G</sub> = 2.7Ω
t <sub>f</sub>	Fall Time	—	22	—		V <sub>GS</sub> = 10V
C <sub>iss</sub>	Input Capacitance	—	5380	—	pF	V <sub>GS</sub> = 0V
C <sub>oss</sub>	Output Capacitance	—	410	—		V <sub>DS</sub> = 50V
C <sub>rss</sub>	Reverse Transfer Capacitance	—	86	—		f = 1.0MHz
C <sub>oss eff.(ER)</sub>	Effective Output Capacitance (Energy Related)	—	360	—		V <sub>GS</sub> = 0V, V <sub>DS</sub> = 0V to 160V <sup>⑥</sup>
C <sub>oss eff.(TR)</sub>	Output Capacitance (Time Related)	—	590	—		See Fig.11
						V <sub>GS</sub> = 0V, V <sub>DS</sub> = 0V to 160V <sup>⑤</sup>

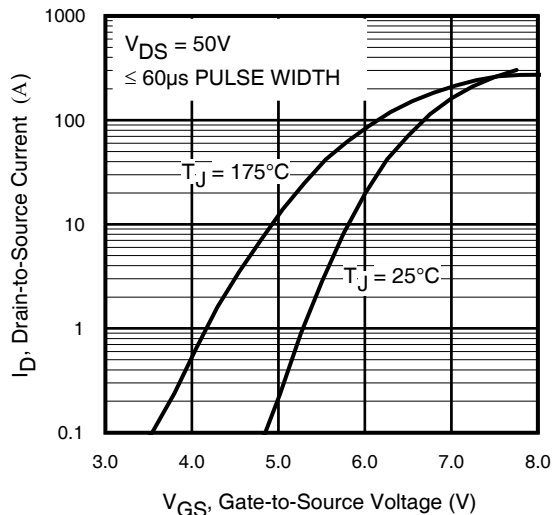
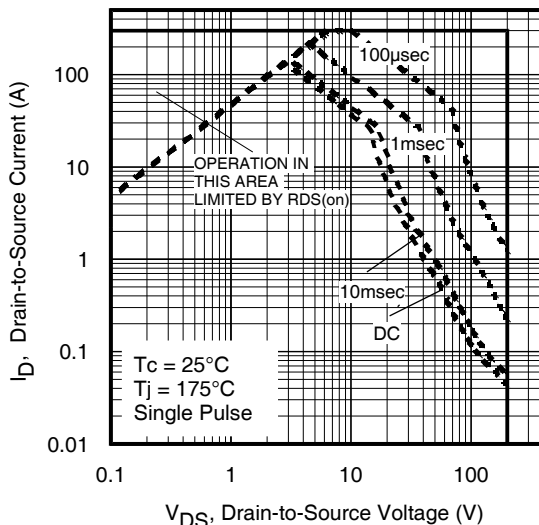
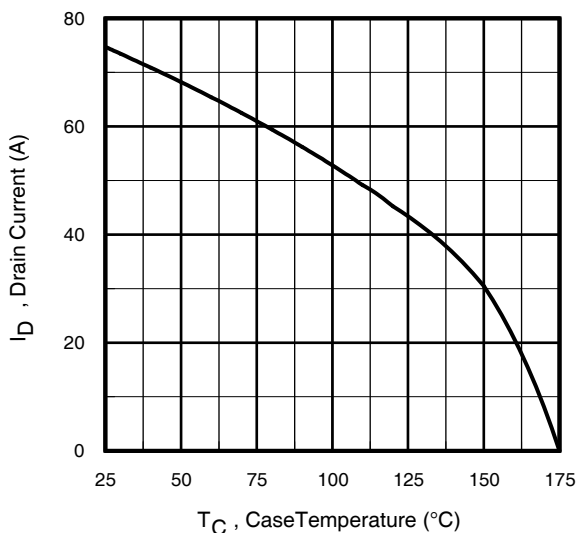
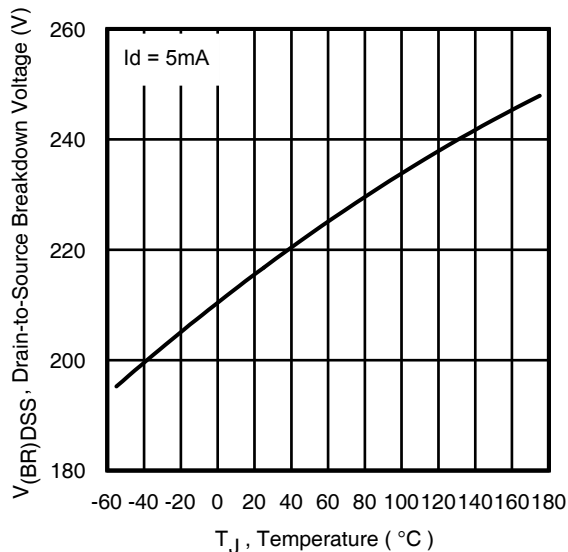
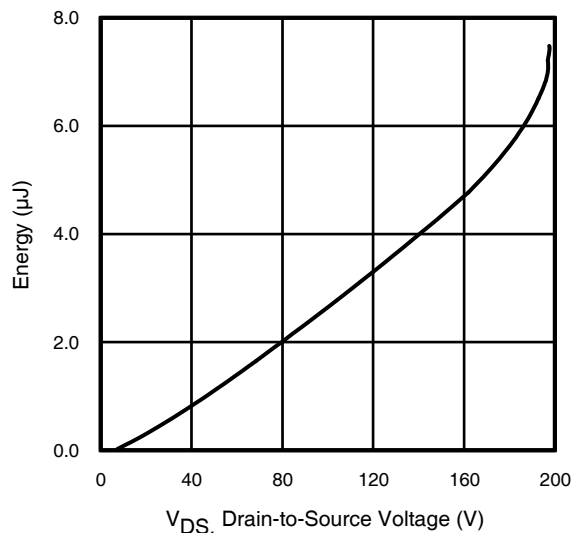
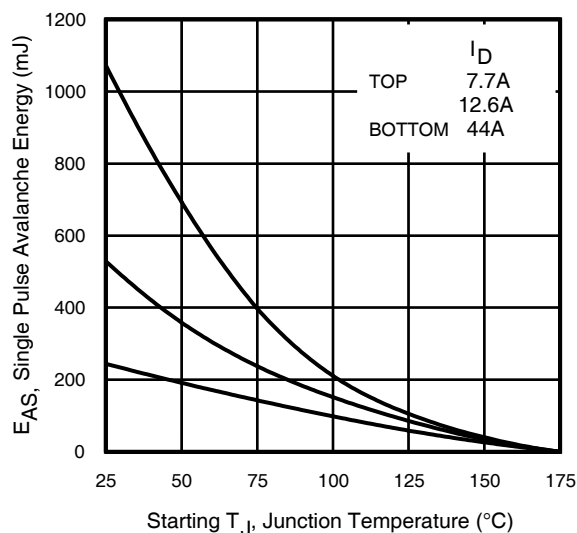
**Diode Characteristics**

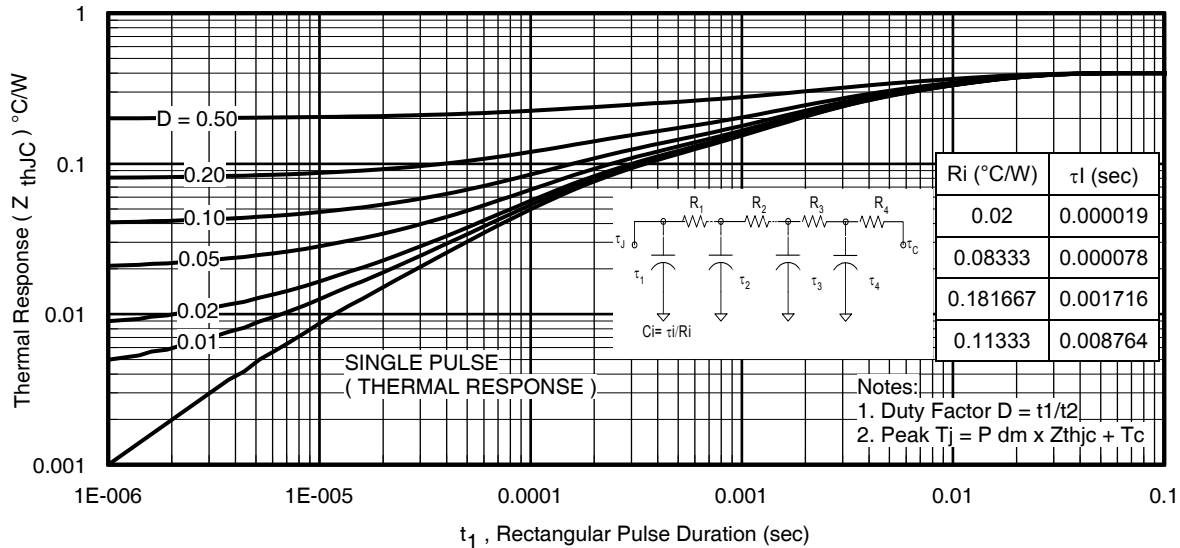
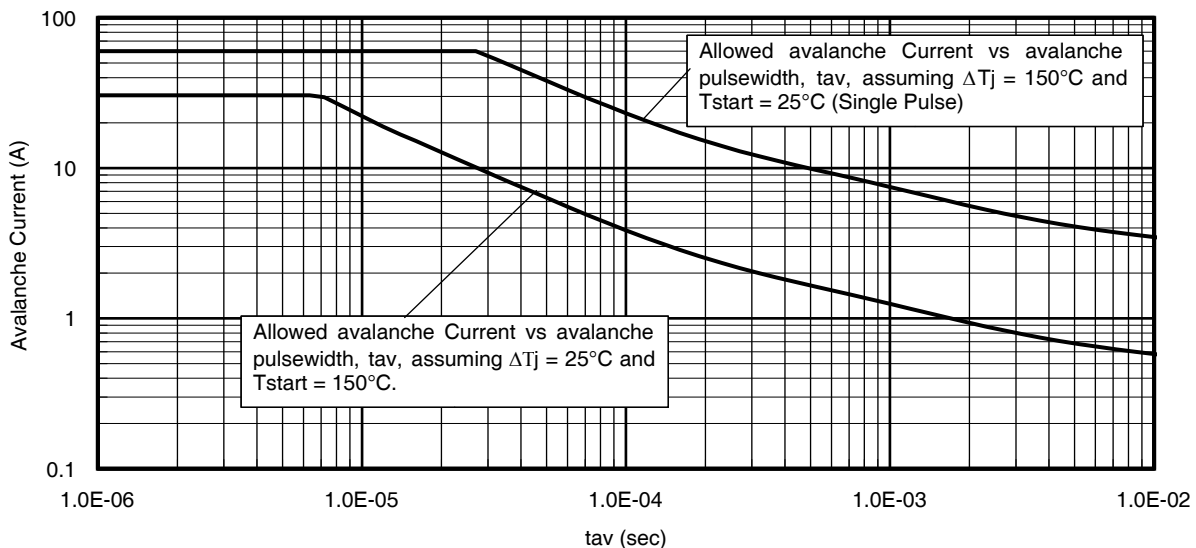
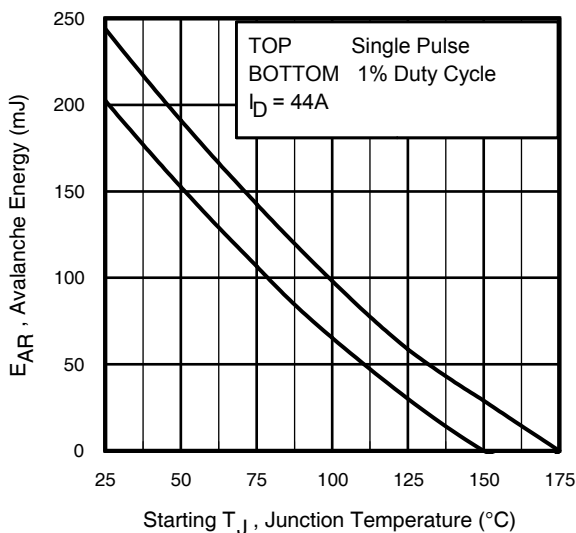
	Parameter	Min.	Typ.	Max.	Units	Conditions
I <sub>S</sub>	Continuous Source Current (Body Diode) ①	—	—	75	A	MOSFET symbol showing the integral reverse p-n junction diode. 
I <sub>SM</sub>	Pulsed Source Current (Body Diode) ①	—	—	300		
V <sub>SD</sub>	Diode Forward Voltage	—	—	1.3	V	T <sub>J</sub> = 25°C, I <sub>S</sub> = 44A, V <sub>GS</sub> = 0V ④
t <sub>rr</sub>	Reverse Recovery Time	—	136	—	ns	T <sub>J</sub> = 25°C V <sub>DD</sub> = 100V
		—	139	—		T <sub>J</sub> = 125°C I <sub>F</sub> = 44A,
Q <sub>rr</sub>	Reverse Recovery Charge	—	458	—	nC	T <sub>J</sub> = 25°C di/dt = 100A/μs ④
		—	688	—		T <sub>J</sub> = 125°C
I <sub>RRM</sub>	Reverse Recovery Current	—	8.3	—	A	T <sub>J</sub> = 25°C

**Notes:**

- ① Repetitive rating; pulse width limited by max. junction temperature.
- ② Recommended max EAS limit, starting T<sub>J</sub> = 25°C, L = 0.25mH, R<sub>G</sub> = 25Ω, I<sub>AS</sub> = 44A, V<sub>GS</sub> = 10V.
- ③ I<sub>SD</sub> ≤ 44A, di/dt ≤ 760A/μs, V<sub>DD</sub> ≤ V<sub>(BR)DSS</sub>, T<sub>J</sub> ≤ 175°C.
- ④ Pulse width ≤ 400μs; duty cycle ≤ 2%.
- ⑤ C<sub>oss eff. (TR)</sub> is a fixed capacitance that gives the same charging time as C<sub>oss</sub> while V<sub>DS</sub> is rising from 0 to 80% V<sub>DSS</sub>.
- ⑥ C<sub>oss eff. (ER)</sub> is a fixed capacitance that gives the same energy as C<sub>oss</sub> while V<sub>DS</sub> is rising from 0 to 80% V<sub>DSS</sub>.
- ⑦ When mounted on 1" square PCB (FR-4 or G-10 Material). For recommended footprint and soldering techniques refer to application note #AN-994
- ⑧ R<sub>θ</sub> is measured at T<sub>J</sub> approximately 90°C


**Fig 1. Typical Output Characteristics**

**Fig 2. Typical Output Characteristics**

**Fig 3. Typical Transfer Characteristics**

**Fig 4. Normalized On-Resistance vs. Temperature**

**Fig 5. Typical Capacitance vs. Drain-to-Source Voltage**

**Fig 6. Typical Gate Charge vs. Gate-to-Source Voltage**


**Fig 7.** Typical Source-Drain Diode Forward Voltage

**Fig 8.** Maximum Safe Operating Area

**Fig 9.** Maximum Drain Current vs. Case Temperature

**Fig 10.** Drain-to-Source Breakdown Voltage

**Fig 11.** Typical  $C_{oss}$  Stored Energy

**Fig 12.** Maximum Avalanche Energy vs. Drain Current


**Fig 13. Maximum Effective Transient Thermal Impedance, Junction-to-Case**

**Fig 14. Typical Avalanche Current vs. Pulse Width**

**Notes on Repetitive Avalanche Curves, Figures 14, 15:  
 (For further info, see AN-1005 at www.irf.com)**

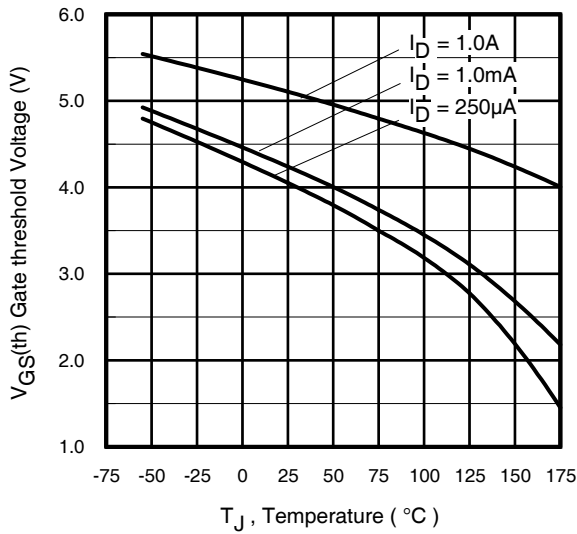
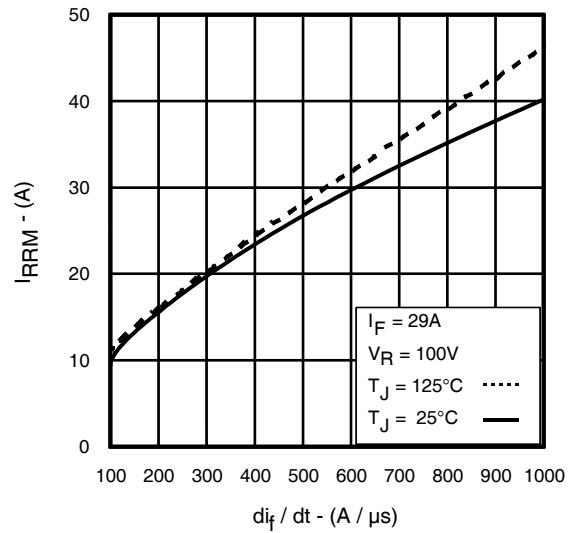
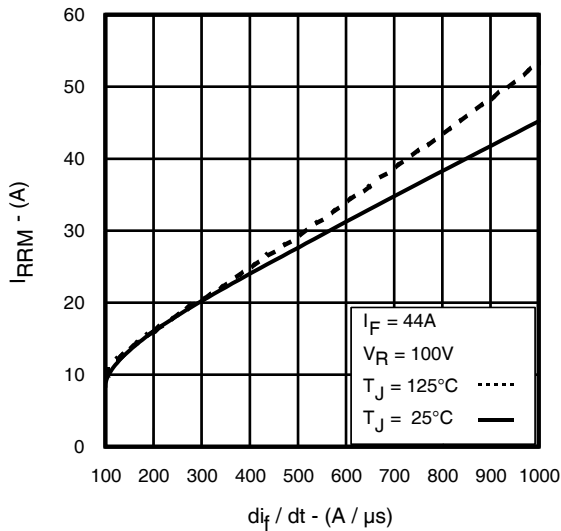
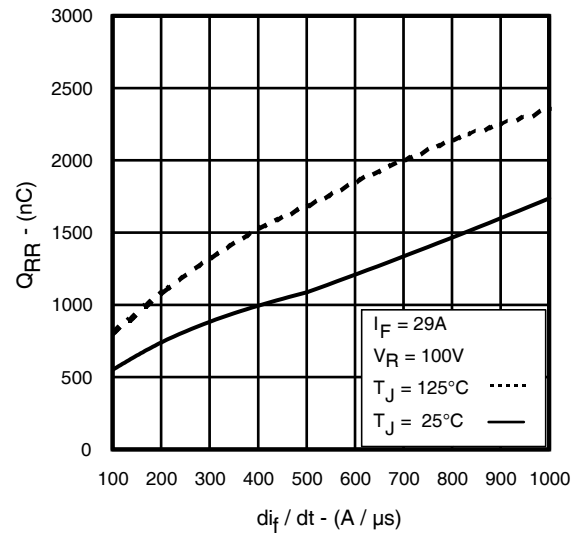
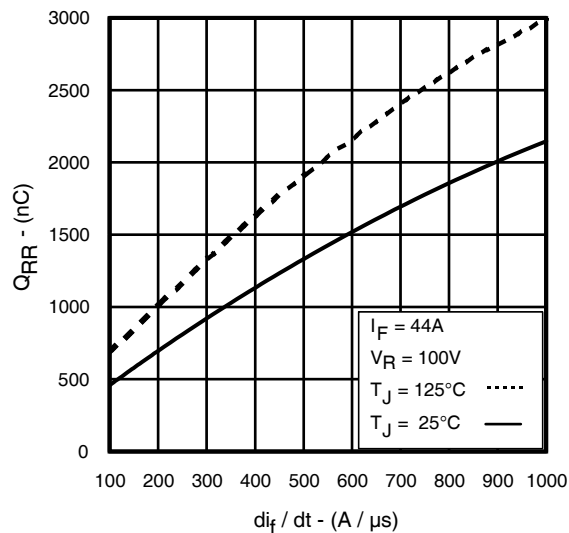
1. Avalanche failures assumption:  
Purely a thermal phenomenon and failure occurs at a temperature far in excess of  $T_{Imax}$ . This is validated for every part type.
2. Safe operation in Avalanche is allowed as long as  $T_{Imax}$  is not exceeded.
3. Equation below based on circuit and waveforms shown in Fig 22a, 22b.
4.  $P_{D(ave)}$  = Average power dissipation per single avalanche pulse.
5.  $BV$  = Rated breakdown voltage (1.3 factor accounts for voltage increase during avalanche).
6.  $I_{AV}$  = Allowable avalanche current.
7.  $\Delta T$  = Allowable rise in junction temperature, not to exceed  $T_{Imax}$  (assumed as 25°C in Fig 14, 15).  
 $t_{AV}$  = Average time in avalanche.  
 $D$  = Duty cycle in avalanche =  $t_{AV} \cdot f$   
 $Z_{thJC}(D, t_{AV})$  = Transient thermal resistance, see Fig 13.

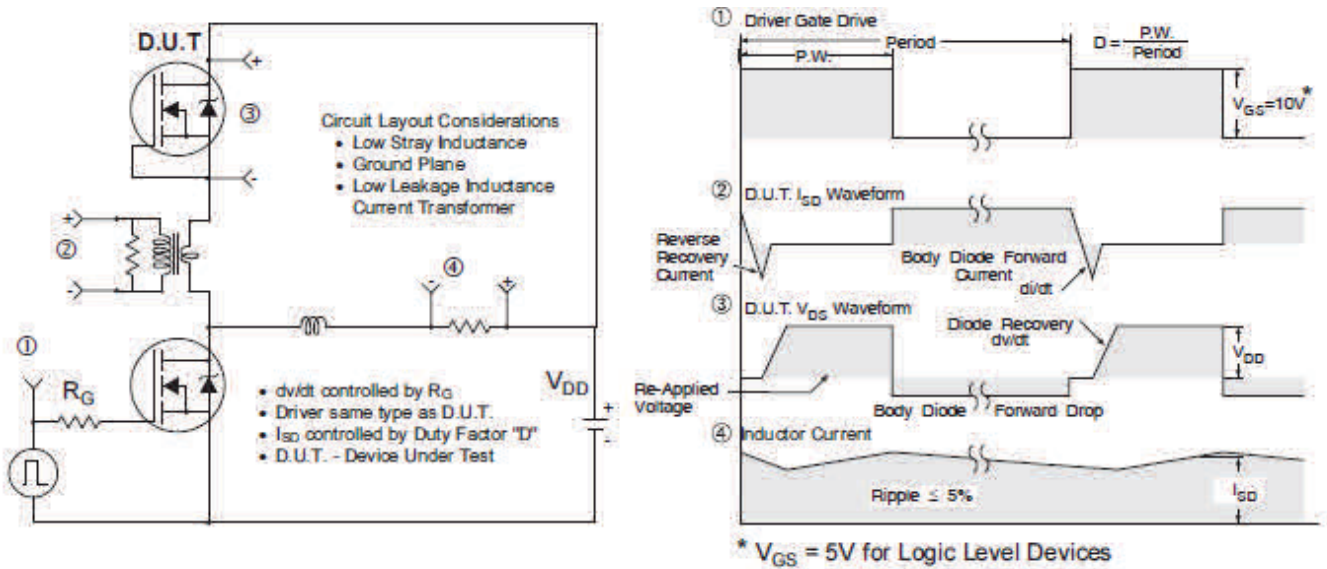
$$P_{D(ave)} = 1/2 (1.3 \cdot BV \cdot I_{AV}) = \Delta T / Z_{thJC}$$

$$I_{AV} = 2\Delta T / [1.3 \cdot BV \cdot Z_{thJC}]$$

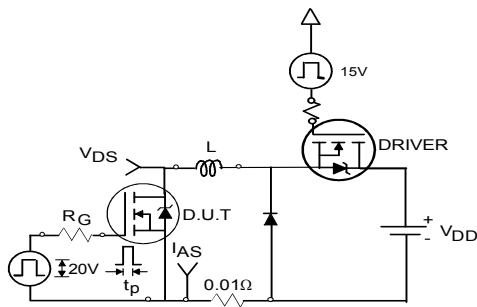
$$E_{AS(AV)} = P_{D(ave)} \cdot t_{AV}$$

**Fig 15. Maximum Avalanche Energy vs. Temperature**

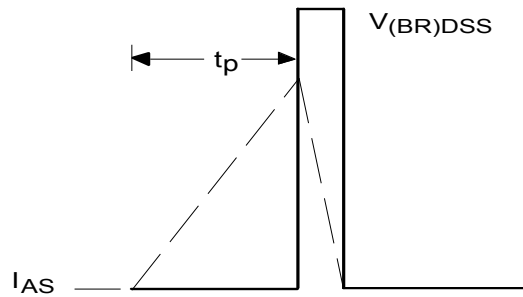

**Fig 16.** Threshold Voltage vs. Temperature

**Fig 17.** Typical Recovery Current vs. dif/dt

**Fig 18.** Typical Recovery Current vs. dif/dt

**Fig 19.** Typical Stored Charge vs. dif/dt

**Fig 20.** Typical Stored Charge vs. dif/dt



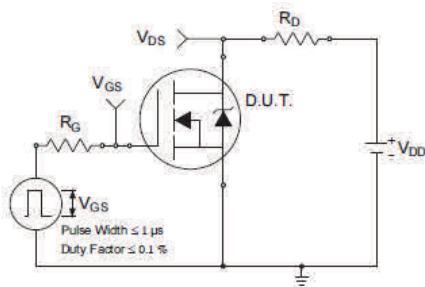
**Fig 21.** Peak Diode Recovery dv/dt Test Circuit for N-Channel HEXFET® Power MOSFETs



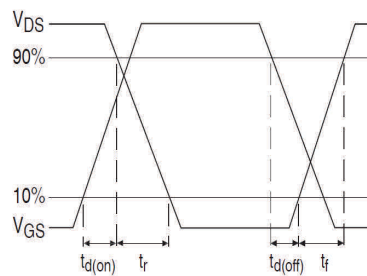
**Fig 22a.** Unclamped Inductive Test Circuit



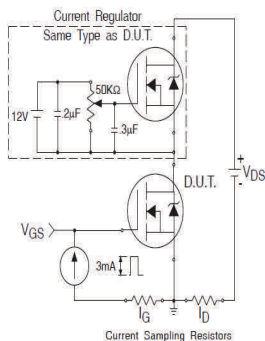
**Fig 22b.** Unclamped Inductive Waveforms



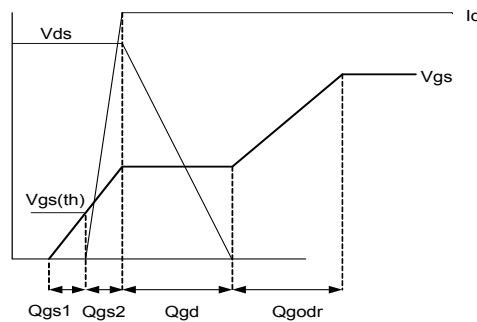
**Fig 23a.** Switching Time Test Circuit



**Fig 23b.** Switching Time Waveforms



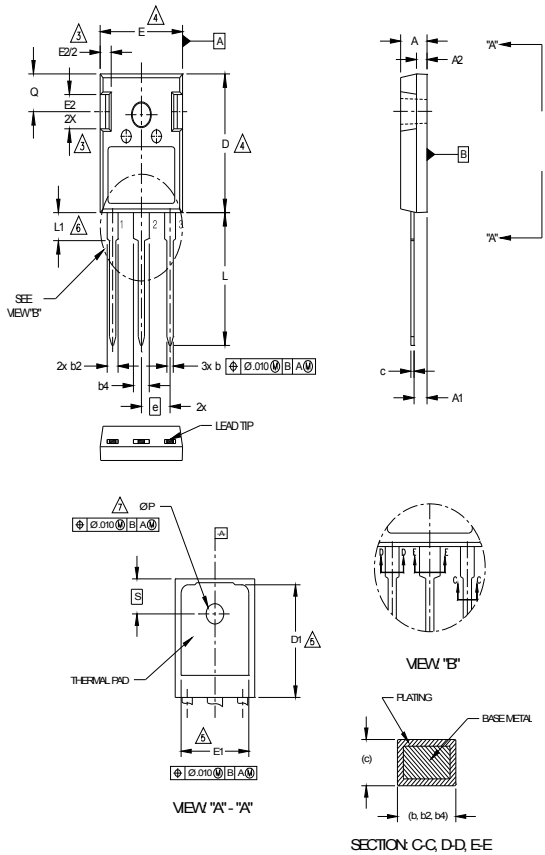
**Fig 24a.** Gate Charge Test Circuit



**Fig 24b.** Gate Charge Waveform

## TO-247AC Package Outline

Dimensions are shown in millimeters (inches)



SYMBOL	DIMENSIONS				NOTES
	INCHES		MILLIMETERS		
	MIN.	MAX.	MIN.	MAX.	
A	.190	.204	4.83	5.20	4 5 4
A1	.090	.100	2.29	2.54	
A2	.075	.085	1.91	2.16	
b	.042	.052	1.07	1.33	
b2	.075	.094	1.91	2.41	
b4	.113	.133	2.87	3.38	
c	.022	.026	0.55	0.68	
D	.819	.830	20.80	21.10	
D1	.640	.694	16.25	17.65	
E	.620	.635	15.75	16.13	
E1	.512	.570	13.00	14.50	
E2	.145	.196	3.68	5.00	
e	.215 Typical		5.45 Typical		
L	.780	.800	19.80	20.32	
L1	.161	.173	4.10	4.40	
ø P	.138	.143	3.51	3.65	
Q	.216	.236	5.49	6.00	
S	.238	.248	6.04	6.30	

**LEAD ASSIGNMENTS**
**HEXFET**

- 1.- GATE
- 2.- DRAIN
- 3.- SOURCE
- 4.- DRAIN

**IGBTs, CoPACK**

- 1.- GATE
- 2.- COLLECTOR
- 3.- EMITTER
- 4.- COLLECTOR

**DIODES**

- 1.- ANODE/OPEN
- 2.- CATHODE
- 3.- ANODE

**NOTES:**

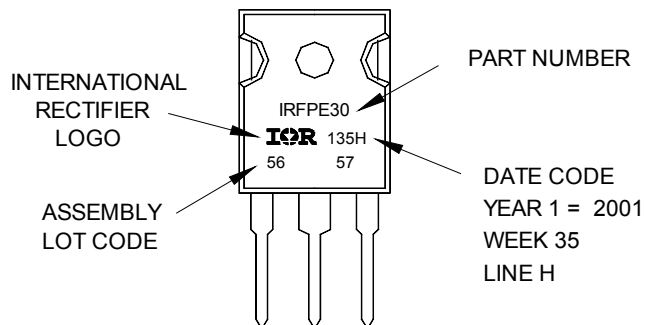
- 1 DIMENSIONING AND TOLERANCING AS PER ASME Y14.5M 1994.
- 2 DIMENSIONS ARE SHOWN IN INCHES AND MILLIMETERS.
- 3 CONTOUR OF SLOT OPTIONAL.
- 4 DIMENSION D & E DO NOT INCLUDE MOLD FLASH. MOLD FLASH SHALL NOT EXCEED .005" (0.127) PER SIDE. THESE DIMENSIONS ARE MEASURED AT THE OUTERMOST EXTREMES OF THE PLASTIC BODY.
- 5 THERMAL PAD CONTOUR OPTIONAL WITHIN DIMENSIONS D1 & E1.
- 6 LEAD FINISH UNCONTROLLED IN L1.
- 7 ø P TO HAVE A MAXIMUM DRAFT ANGLE OF 1.5° TO THE TOP OF THE PART WITH A MAXIMUM HOLE DIAMETER OF .154 INCH.

## TO-247AC Part Marking Information

Notes: This part marking information applies to devices produced after 02/26/2001

EXAMPLE: THIS IS AN IRFPE30  
WITH ASSEMBLY  
LOT CODE 5657  
ASSEMBLED ON WW 35, 2001  
IN THE ASSEMBLY LINE "H"

Note: "P" in assembly line position  
indicates "Lead-Free"



TO-247AC package is not recommended for Surface Mount Application.

Note: For the most current drawing please refer to IR website at <http://www.irf.com/package/>



**Qualification Information<sup>†</sup>**

<b>Qualification Level</b>	Industrial (per JEDEC JESD47F) <sup>††</sup>	
<b>Moisture Sensitivity Level</b>	TO-247AC	N/A
<b>RoHS Compliant</b>	Yes	

† Qualification standards can be found at International Rectifier's web site: <http://www.irf.com/product-info/reliability/>

†† Applicable version of JEDEC standard at the time of product release.

Data and specifications subject to change without notice.

International  
 Rectifier

**IR WORLD HEADQUARTERS:** 101N Sepulveda., El Segundo, California 90245, USA Tel: (310) 252-7105

TAC Fax: (310) 252-7903

Visit us at [www.irf.com](http://www.irf.com) for sales contact information.

## **IMPORTANT NOTICE**

The information given in this document shall in no event be regarded as a guarantee of conditions or characteristics ("Beschaffheitsgarantie").

With respect to any examples, hints or any typical values stated herein and/or any information regarding the application of the product, Infineon Technologies hereby disclaims any and all warranties and liabilities of any kind, including without limitation warranties of non-infringement of intellectual property rights of any third party.

In addition, any information given in this document is subject to customer's compliance with its obligations stated in this document and any applicable legal requirements, norms and standards concerning customer's products and any use of the product of Infineon Technologies in customer's applications.

The data contained in this document is exclusively intended for technically trained staff. It is the responsibility of customer's technical departments to evaluate the suitability of the product for the intended application and the completeness of the product information given in this document with respect to such application.

For further information on the product, technology, delivery terms and conditions and prices please contact your nearest Infineon Technologies office ([www.infineon.com](http://www.infineon.com)).

## **WARNINGS**

Due to technical requirements products may contain dangerous substances. For information on the types in question please contact your nearest Infineon Technologies office.

Except as otherwise explicitly approved by Infineon Technologies in a written document signed by authorized representatives of Infineon Technologies, Infineon Technologies' products may not be used in any applications where a failure of the product or any consequences of the use thereof can reasonably be expected to result in personal injury.