

## AM512B - angular magnetic encoder IC

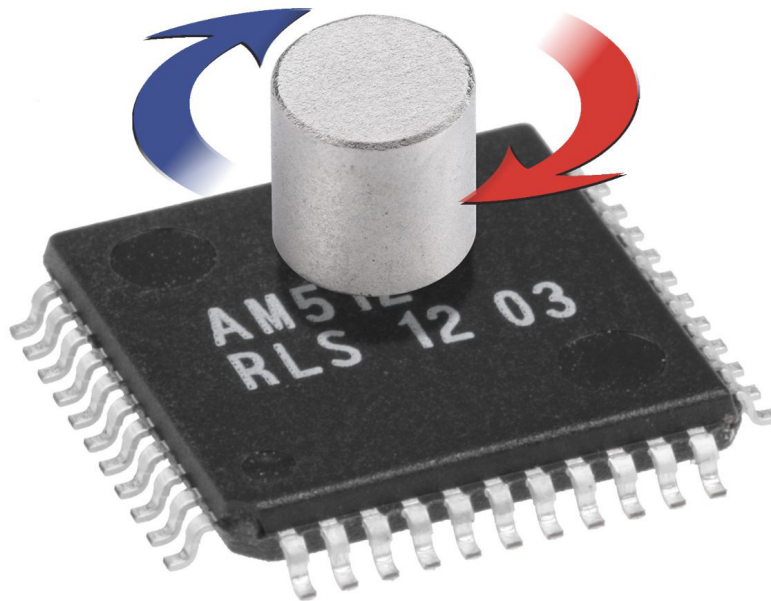

### The AM512B is a compact solution for angular position sensing.

The IC senses the angular position of a permanent magnet placed above the chip. The permanent magnet must be diametrically polarized and of cylindrical shape.

The AM512B uses Hall sensor technology to detect the magnetic flux density distribution at the surface of the silicon. Hall sensors are placed in a circular array around the center of the IC and deliver a voltage representation of the magnetic field distribution.

The sine and cosine voltage outputs from the sensor array vary with magnet position. The sine and cosine signals are then converted to absolute angle position with a fast nine bit flash interpolator.

The absolute angle position value from the interpolator is output either

through a parallel binary interface or a serial voltage output. The relative changes of the angle position are also output as incremental A QUAD B encoder signals. The resolution of incremental output is 512 counts per turn.

With its compact size the AM512B angular magnetic encoder is especially suitable for different applications, including motor motion control, flow measurement, robotics, camera positioning, front panel switches, workshop equipment, mobility aids, potentiometer replacement, etc.

Output options:

- Incremental
- Parallel
- Serial SSI
- Analogue sinusoidal

- Contactless angular position encoding over 360°
- Ideal for harsh environments due to magnetic sensing
- Complete system-on-chip solution
- 9 bit absolute encoder
- Factory optimized linearity
- High rotational speed up to 30,000 rpm
- 5 V power supply
- Low power consumption. 20 mA typical.
- Extended operating temperature range (-40 °C to +125 °C)
- SMD package LQFP44
- RoHS compliant

Data sheet  
**AM512BD01\_08**

**Pin description**

Table shows the description for each pin of the standard LQFP44 package.

Pin	Name	Pin description	
		PS = Low (parallel output)	PS = High (serial and incremental output)
1	Prog	OTP setup input. Connect to $V_{ss}$ *	OTP setup input. Connect to $V_{ss}$ *
2	Prg	OTP setup input. Do not connect *	OTP setup input. Do not connect *
3	Error	Output for monitoring	Output for monitoring
4	Cos	Cosine analogue output for monitoring and filtering	Cosine analogue output for monitoring and filtering
5	Sin	Sine analogue output for monitoring and filtering	Sine analogue output for monitoring and filtering
6	NC	Not used, must leave unconnected	Not used, must leave unconnected
7	NC	Not used, must leave unconnected	Not used, must leave unconnected
8	D8	D8 (MSB) bit of parallel outputs	Not used, must leave unconnected
9	D7/Data	D7 bit of parallel outputs	Data output for SSI
10	D6/ $V_{out}$	D6 bit of parallel outputs	Linear voltage output
11	D5	D5 bit of parallel outputs	Not used, must leave unconnected
12	BP	Back plane - connect to $V_{ss}$	Back plane - connect to $V_{ss}$
13	$V_{ss}$	Power supply 0 V	Power supply 0 V
14	D4	D4 bit of parallel outputs	Not used, must leave unconnected
15	D3/A	D3 bit of parallel outputs	Incremental output A
16	D2/Ri	D2 bit of parallel outputs	Incremental output Ri
17	$V_{dd}$	Power supply +5 V	Power supply +5 V
18	D1/B	D1 bit of parallel outputs	Incremental output B
19	D0	D0 (LSB) bit of parallel outputs	Not used, must leave unconnected
20	CS	Chip select. If high then digital output pins are in high impedance	Chip select. If high then digital output pins are in high impedance
21	Clock	Not used, must leave unconnected	Clock input for SSI
22	BP	Back plane – connect to $V_{ss}$	Back plane – connect to $V_{ss}$
23	$V_{ss}$	Power supply 0 V	Power supply 0 V
24	RefN	Not used, connect to $V_{ss}$	Input to define a minimum value of $V_{out}$ range
25	$V_{dd}$	Power supply +5 V	Power supply +5 V
26	$V_{ss}$	Power supply 0 V	Power supply 0 V
27	DL	Data latch (active high)	Data latch (active high)
28	NC	Not used, must leave unconnected	Not used, must leave unconnected
29	$V_{ss}$	Power supply 0 V	Power supply 0 V
30	$V_{ss}$	Power supply 0 V	Power supply 0 V
31	$V_{ss}$	Power supply 0 V	Power supply 0 V
32	$V_{dd}$	Power supply +5 V	Power supply +5 V
33	$V_{dd}$	Power supply +5 V	Power supply +5 V
34	BP	Back plane - connect to $V_{ss}$	Back plane - connect to $V_{ss}$
35	RefP	Not used, connect to $V_{dd}$	Input to define a maximum value of $V_{out}$ range
36	Agnd	Analogue reference	Analogue reference
37	Agndi	Analogue reference input	Analogue reference input
38	$I_{hal}$	Input for hall sensor bias current (18 K to $V_{dd}$ )	Input for hall sensor bias current (18 K to $V_{dd}$ )
39	NC	Not used	Not used
40	$I_{boh}$	Input for amplifier bias current (82 K to $V_{ss}$ )	Input for amplifier bias current (82 K to $V_{ss}$ )
41	R25	Input for setting Agnd voltage (open = $3/5 V_{dd}$ , low = $1/2 V_{dd}$ )	Input for setting Agnd voltage (open = $3/5 V_{dd}$ , low = $1/2 V_{dd}$ )
42	PS	Output mode selection	Output mode selection
43	$V_{ss}$	Power supply 0 V	Power supply 0 V
44	BP	Back plane - connect to $V_{ss}$	Back plane - connect to $V_{ss}$

\* Each AM512B is factory optimized to achieve optimum performance. The information is stored in PROM.

The AM512B has two output modes: parallel output mode and serial, incremental, linear output mode. The desired operational mode can be selected by pin PS. When the mode is changed, functions of some pins are changed.

**Pins 1 and 2** are used for OTP (One Time Programming) of the chip. The OTP is carried out at the factory and defines the behavior and accuracy of the AM512B. In operation pin 1 (Prog) must be connected to  $V_{ss}$  and pin 2 (Prg) must be unconnected.

**Pin 3** (Error) is an analogue output signal. It can be used for monitoring the alignment between the AM512B and the magnet. See the “Error signal” section on page 13 for detailed information.

**Pins 4 and 5** are Cosine and Sine output signals for monitoring and filtering. A low-pass filter can be made with an external capacitor as there is a built-in 10 k $\Omega$  serial resistor. Recommended value for filtering is a 10 nF capacitor connected to  $V_{ss}$ . When a 10 nF capacitor is used for filtering the position information is delayed by an additional 10  $\mu$ s. See the “Position delay” section on page 9 for detailed information.

**Pins 6, 7, 28 and 39** are not connected internally. They can be left unterminated.

**Pins 8, 9, 10, 11, 14, 15, 16, 18, 19** are output pins. The function of each pin is changed when the output mode is changed. See the “Pin description” table on page 2.

**Pins 12, 22, 34, 44** are back plane pins which must be connected to  $V_{ss}$ .

**Pins 13, 17, 23, 25, 26, 29, 30, 31, 32, 33, 43** are power supply pins. All pins must be connected.

**Pin 20** (CS) is a digital input with an internal pull-down resistor. When high, all digital output pins (D8–D0) are set to high impedance mode. This function can be used when several AM512B devices are used in parallel mode.

**Pin 21** (Clock) is a digital input for serial SSI communication. See the “Binary synchronous serial output SSI” section on page 6 for detailed information.

**Pin 24** (RefN) is a reference voltage input for minimum value of the linear output voltage ( $V_{out}$ ).

**Pin 27** (DL) is a digital input with an internal pull-down resistor. The pin is used to latch (freeze) all 9 bits of information. It is used only for parallel output mode. When serial output mode is selected, the signal has no effect.

DL	Function (parallel output mode)
Low	Parallel output is constantly refreshed
High	Parallel output information is latched

**Pin 35** (RefP) is a reference voltage input for maximum value of the linear output voltage ( $V_{out}$ ).

**Pin 36** (Agnd) is a buffered analogue reference output. It is a reference voltage for analogue sinusoidal signals. It is used by the interpolator and for analogue signal outputs.

**Pin 37** (Agndi) is an internally generated reference voltage. It is generated with a  $V_{dd}/V_{ss}$  resistor divider. The resistors values are 20 k $\Omega$  and 30 k $\Omega$ . The reference voltage is 3 V typically (3/5 of power supply voltage). Agndi must be connected to an external 100 nF capacitor. The reference voltage value can be changed to 1/2 of supply voltage by connecting the pin 41 (R25) to  $V_{ss}$ .

**Pin 38** ( $I_{hal}$ ) is used to define the system sensitivity. When a resistor ( $R_{ihal}$ ) is connected from pin 38 ( $I_{hal}$ ) to  $V_{dd}$  a hall sensor bias current is defined. Recommended value for  $R_{ihal}$  is 18 k $\Omega$ . The value of  $R_{ihal}$  can be altered to adjust the sensitivity. See the  $R_{ihal}$ /Signal amplitude characteristic chart on page 15.

**Pin 40** ( $I_{boh}$ ) is used to define the amplifiers bias current. When a resistor ( $R_{lboh}$ ) is connected between pin 40 ( $I_{boh}$ ) and  $V_{ss}$  amplifiers bias current is defined. The value  $R_{lboh}$  must be 82 k $\Omega$ .

**Pin 41** (R25) is used for setting the voltage level of Agnd (open = 3/5  $V_{dd}$ , low = 1/2  $V_{dd}$ ).

**Pin 42** (PS) is a digital input pin with an internal pull-down resistor for selecting the output operation mode.

PS	Output mode
Low	Parallel output mode
High	Serial, incremental and linear output mode

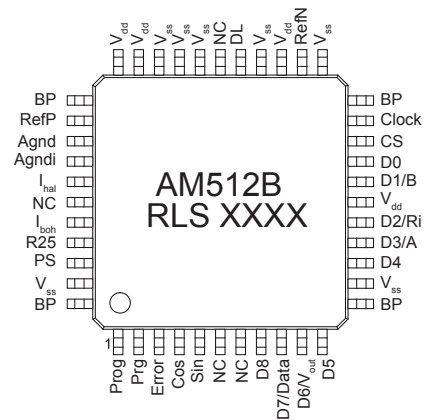

Fig. 1: Pin description

## Absolute maximum ratings

$T_A = 22\text{ °C}$  unless otherwise noted

Parameter	Symbol	Min.	Max.	Unit	Note
Supply voltage	$V_{dd}$	-0.3	7	V	
Input pin voltage	$V_{in}$	-0.3	$V_{dd} + 0.7$	V	
Input current (latch-up immunity)	$I_{scr}$		50	mA	
Electrostatic discharge	ESD		2	kV	*
Junction temperature	$T_j$		160	°C	
Storage temperature range	$T_{st}$	-65	170	°C	
Humidity non-condensing	H	5	85	%	
Moisture sensitivity level			5		

\* Human Body Model

## Operating range conditions

Parameter	Symbol	Min.	Typ.	Max.	Unit	Note
Operating temperature range	$T_o$	-40		125	°C	
Supply voltage	$V_{dd}$	4.75	5	5.25	V	
Supply current	$I_{dd}$	18	20	35	mA	*
Input frequency	$f_{in}$			500	Hz	**
Power-up time	$t_p$			10	ms	***

\* Supply current is changed if some external components are changed. Typ. figure is for recommended values; it does not include output drive currents.

\*\* Input frequency is the magnet rotational speed.

\*\*\* Time between power-on and valid output data.

## Digital outputs

Parameter	Symbol	Min.	Max.	Unit	Note
High level output voltage	$V_{OH}$	4	$V_{dd}$	V	at $I_H < 3\text{ mA}^*$
Low level output voltage	$V_{OL}$	$V_{ss}$	1	V	at $I_L < 3\text{ mA}^{**}$

\*  $I_H$  is high level current, \*\* $I_L$  is low level current

## Digital inputs

Parameter	Symbol	Min.	Max.	Unit	Note
High level output voltage	$V_{IH}$	3.5	$V_{dd}$	V	
Low level output voltage	$V_{IL}$	$V_{ss}$	1.5	V	

## CW or CCW rotation of the magnet

The arrow shows clockwise (CW) rotation of the magnet.  
 The picture is a top view of the magnet placed above the AM512B.  
 CCW is counter clockwise rotation.

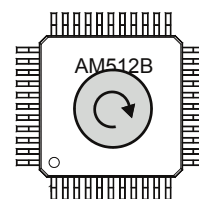

Fig. 2: CW rotation of the magnet

## Sinusoidal analogue output for monitoring

Agnd is an internally generated reference voltage. It is used as a zero level for the analogue signals. When pin 41 is open the Agnd voltage is 3/5 of  $V_{dd}$ . If pin 41 is connected to  $V_{ss}$  the Agnd voltage is 1/2 of  $V_{dd}$ .

Pins 4 and 5 are unbuffered sinusoidal analogue outputs and they must only be used with a high impedance load. They are used for filtering and they can be used for monitoring the signals.

Unbuffered sinusoidal outputs:

Parameter	Symbol	Typ.	Unit	Note
Internal serial impedance	$R_n$	10	k $\Omega$	
Short circuit current	$I_o$	150	$\mu A$	When signal level is 1.5 V and connected to Agnd

Timing diagram shows CW rotation of the recommended magnet.

Sinusoidal outputs produce one period of sine and cosine signal per turn with a phase difference of 90°. Each signal has the same amplitude and minimum offset with respect to Agnd.

Sinusoidal output parameters are factory optimized to achieve the best possible accuracy. However, the specified accuracy parameters are only valid for magnets specified and used within alignment tolerances. When a load is applied to the analogue outputs the amplitude is slightly reduced. The load must be the same for both channels to preserve the symmetry.

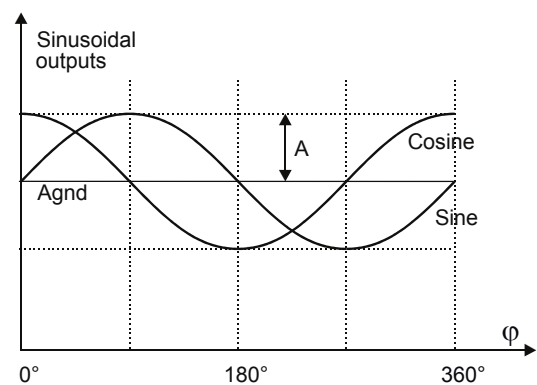

Fig. 3: Timing diagram for analogue output

Sinusoidal signal parameters:

Parameter	Symbol	Min.	Typ.	Max.	Unit	Note
Amplitude	A	0.6	1.2	1.9	V	*
Amplitude difference	$\Delta A_{SC}$			0.2	%	**
Offset Sine	$V_{OSIN}$			3	mV	**
Offset Cosine	$V_{OCOS}$			3	mV	**
Phase error	$\Delta\phi$			0.2	deg	**
Maximum output frequency	$f_{Max}$	500			kHz	

\* Amplitude = 1/2 of peak to peak value, assuming power supply voltage and magnet position are within tolerance.

\*\* Parameters are only valid for ideal shape and position of the magnet. Additional errors can occur if magnet setup position is not achieved. See the "Mounting instructions" section on page 12 for additional information.

## Binary synchronous serial output SSI

Serial output data is available in 9 bit binary code through the SSI protocol. Pin PS must be set high to activate the serial output mode.

By default, with CW rotation of the magnet the value of output data is increasing. It is possible to order an AM512B version with position increasing with CCW rotation of the magnet (special order).

Parameter	Symbol	Min.	Max.	Unit
Clock period	$t_{CL}$	1.2	16	$\mu s$
Clock high	$t_{CHI}$	0.6	15.6	$\mu s$
Clock low	$t_{CLO}$	0.6	15.6	$\mu s$
Monoflop time	$t_m$	16	22	$\mu s$

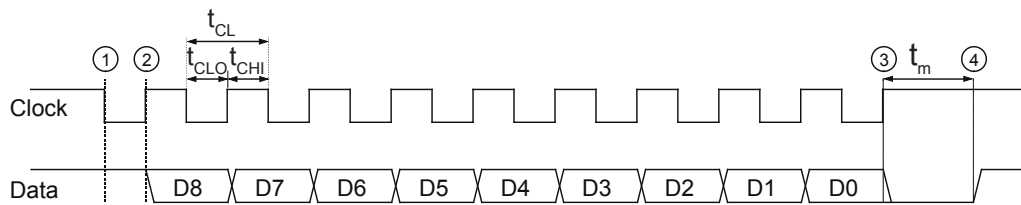

Fig. 4: SSI timing diagram

The controller interrogates the AM512B for its positional value by sending a pulse train to the Clock input. The Clock signal must always start from high. The first high/low transition (point 1) stores the current position data in a parallel/serial converter and the monoflop is triggered. With each transition of Clock signal (high/low or low/high) the monoflop is retriggered. At the first low/high transition (point 2) the most significant bit (MSB) of binary code is transmitted through the Data pin to the controller. At each subsequent low/high transition of Clock the next bit is transmitted to the controller. While reading the data the  $t_{CHI}$  and  $t_{CLO}$  must be less than  $t_{mMin}$  to keep the monoflop set. After the least significant bit (LSB) is output (point 3) the Data goes to low. The controller must wait longer than  $t_{mMax}$  before it can read updated position data. At this point the monoflop time expires and the Data output goes to high (point 4).

It is possible to read the same position data several times to enlarge the reliability of transmitted data. The controller must continue sending the Clock pulses and the same data will be output again. Between the two outputs one logic zero will be output.

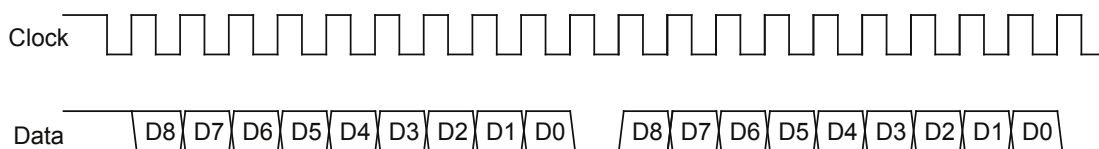

Fig. 5: SSI multi-read of the same position data

## Binary parallel output

Parallel output data is available in 9 bit binary code. To activate parallel output the PS pin must be set low. Output data can be latched while reading the data.

For CW rotation of the magnet the output position is increasing. It is possible to order an A512B version with position increasing for CCW rotation of the magnet (special order).

## Incremental output

There are three signals for incremental output: A, B and Ri. Signals A and B are quadrature signals, shifted by 90°, and signal Ri is a reference mark. One revolution generates 128 pulses. The number of counts per revolution post quadrature evaluation is 512 ( $128 \times 4 = 512$ ). The reference mark signal is produced once per revolution. The width of the Ri pulse is 1/4 of the quadrature signal period.

Figure 6 shows the timing diagram of A, B and Ri signals with CW rotation of the magnet. B leads A for CW rotation of the magnet. The counting direction can be changed by swapping the A and B signals.

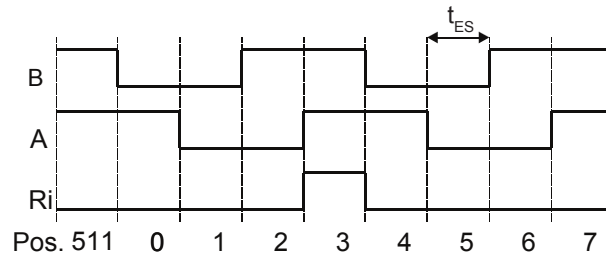

Fig. 6: Timing diagram for incremental output

Edge separation time:

Parameter	Symbol	Ideal	Min.	Unit	Note
Edge separation time	$t_{ES}$	19.5	6	$\mu s$	at 6,000 rpm
Edge separation time	$t_{ES}$	3.9	1.2	$\mu s$	at 30,000 rpm

## Linear voltage output

The angular position is converted into digital position information. The digital information is then converted into linear voltage with a built-in 9 bit DA converter. The linear output voltage is a sawtooth shape and lies within thresholds defined with two external pins RefP and RefN. There are four different options available for the output signal period. Default option is one period per 360°. Two, four and eight periods per 360° are also available by special order (see ordering information).

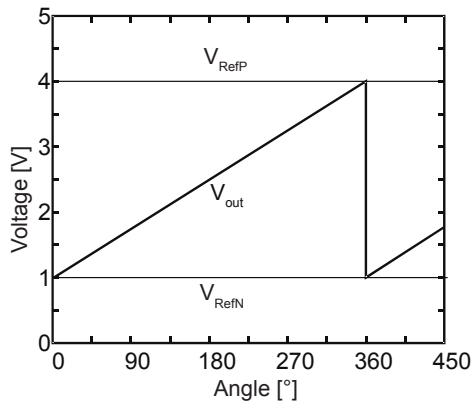

Fig. 7: One period per 360°

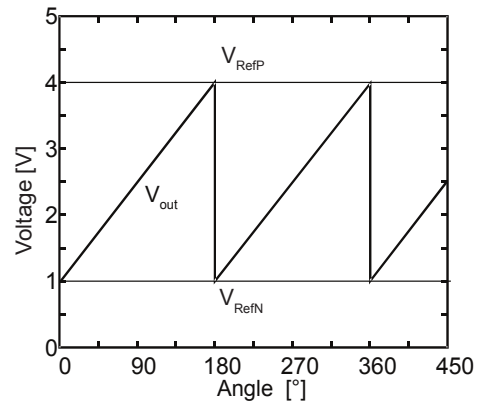

Fig. 8: Two periods per 360°

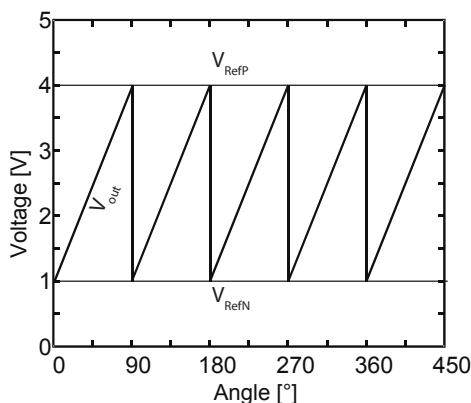

Fig. 9: Four periods per 360°

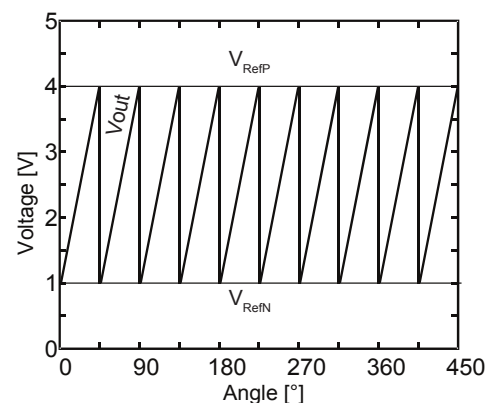

Fig. 10: Eight periods per 360°

### Transfer characteristics of the DAC:

#### Terminology:

##### RELATIVE ACCURACY:

For the DAC, Relative Accuracy or Integral Nonlinearity (INL) is a measure of the maximum deviation, in LSBs, from a straight line passing through the actual endpoints of the DAC transfer function.

##### OFFSET ERROR:

This is a measure of the offset error of the DAC and the output amplifier.

##### GAIN ERROR:

This is a measure of the span error of the DAC (including any error in the gain of the buffer amplifier). It is the deviation in slope of the actual DAC transfer characteristic from the ideal expressed as a percentage of the full-scale range.

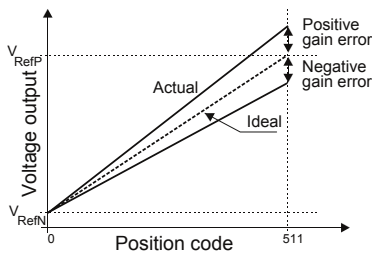

Fig. 11: Gain error for DAC

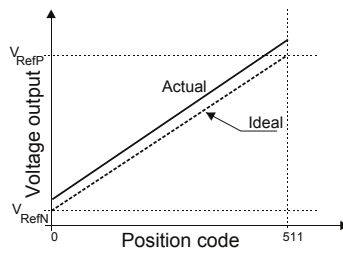

Fig. 12: Offset error for DAC

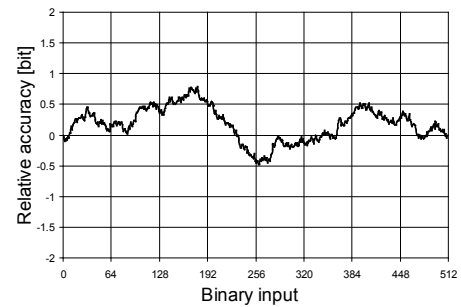

Fig. 13: Typical relative accuracy plot for DAC

#### Transfer characteristic at ideal DAC with no errors:

Digital input value	Analogue output value
0	$\frac{1}{512} \times (V_{\text{RefP}} - V_{\text{RefN}})$
511	$V_{\text{RefP}} - \frac{1}{512} \times (V_{\text{RefP}} - V_{\text{RefN}})$

#### DAC reference inputs characteristic:

Parameter	Symbol	Min.	Typ.	Max.	Unit	Note
$V_{\text{RefP}}$ input impedance	$R_{\text{VrfP}}$		15.6		k $\Omega$	
$V_{\text{RefN}}$ input impedance	$R_{\text{VrfN}}$		4.8		k $\Omega$	
$V_{\text{RefP}}$ input range		$V_{\text{ss}}$		$V_{\text{dd}} - 100 \text{ mV}$		*
$V_{\text{RefN}}$ input range		$V_{\text{ss}}$		$V_{\text{dd}}/2$		

\* The  $V_{\text{RefP}}$  maximal value must be approx. 100 mV below  $V_{\text{dd}}$  to prevent a saturation of the output because of the possible gain and offset error.

#### DAC voltage output characteristic:

Parameter	Symbol	Typ.	Unit	Note
Minimum output voltage	$V_{\text{OutMin}}$	0	V	
Maximum output voltage	$V_{\text{OutMax}}$	$V_{\text{dd}} - 23 \text{ mV}$	mV	*
Output impedance	$R_{\text{Out}}$	28.2	$\Omega$	

\* When the output is unloaded.

#### DAC voltage output characteristic:

Parameter	Min.	Typ.	Max.	Unit	Note
Resolution		9		bits	
Gain		1			
Relative accuracy		$\pm 0.6$	$\pm 1$	LSB	*
Gain error	-1	-0.3	1	%	
Offset error	-1	3	10	mV	

\* 1/2 peak to peak value of relative accuracy plot.



## Hysteresis

The AM512B uses an electrical hysteresis when converting analogue signals to digital. The hysteresis prevents the flickering of the digital output at a stationary magnet position. The effect is a position hysteresis when rotating the magnet CW or CCW.

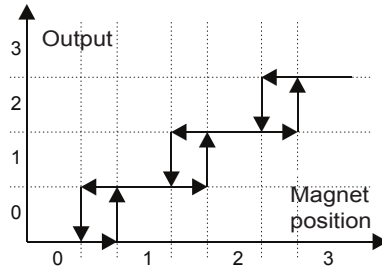

Fig. 14: Hysteresis

Parameter	Symbol	Min.	Typ.	Max.	Unit	Note
Hysteresis	Hyst.	0.3	0.45	0.6	deg	*

\* The hysteresis depends on the signal amplitude. A higher amplitude means a lower hysteresis.

## Position delay

At high rotational speed a position delay between the magnet position and the electrical output appears because of filtering. Filtering is carried out with an RC filter. The value of the resistor is 10 kΩ and the recommended value of the capacitor is 10 nF. Position delay can be calculated as follows:

$$\Delta\varphi = \text{Arc tan}\{f / f_0\} \quad (f = \text{frequency}, f_0 = (2\pi RC)^{-1})$$

At high rotational speed the amplitude decreases.

Parameter	Symbol	Typ.	Unit	Note
Position delay	$\Delta\varphi_{\text{pos}}$	0.36	deg	at 10 Hz, C = 10 nF
		3.6		at 100 Hz, C = 10 nF
Amplitude decreasing	$\Delta A$	0.2	%	at 100 Hz, C = 10 nF
		4.6		at 500 Hz, C = 10 nF

## Nonlinearity

Nonlinearity is defined as the difference between the actual angular position of the magnet and the angular position output from the AM512B. Readings are compared at each output position change.

Integral nonlinearity is the total position error of the AM512B output. Figure 15 on page 10 shows a typical error plot if the recommended magnet is carefully positioned. Figure 16 shows the error plot if the magnet is on the limit of alignment tolerances. Integral nonlinearity includes magnet misalignment error, differential nonlinearity and transition noise.

Differential nonlinearity is the difference between the measured position step and the ideal position step. Figure 17 on page 10 shows a typical differential nonlinearity plot. This is a function of the interpolator accuracy. Differential nonlinearity is repeatable to the transition noise if it is re-measured.

The difference between two differential measurements represents the transition noise. Transition noise is a consequence of electrical noise in the analogue signals (see figure 18).

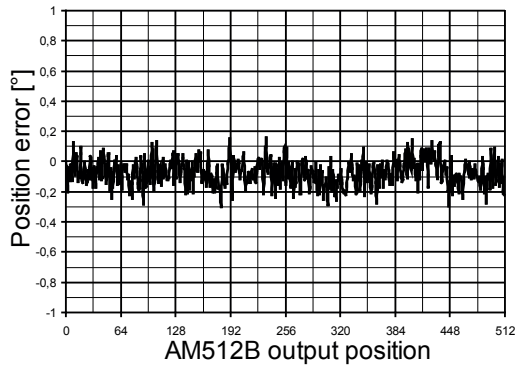

Fig. 15: Typical integral nonlinearity plot with good magnet setup

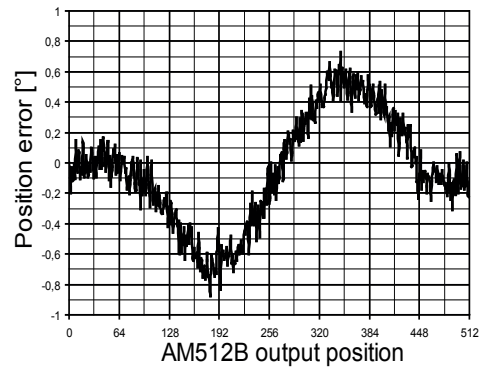

Fig. 16: Typical integral nonlinearity plot if the magnet is on the limit of alignment tolerances

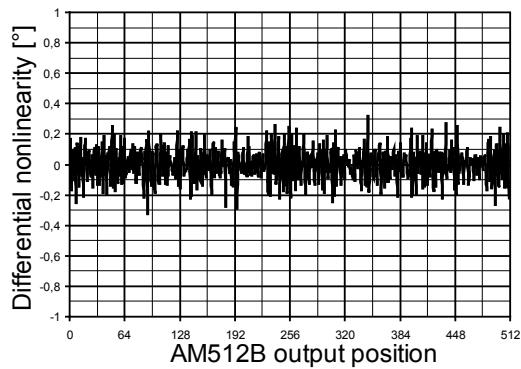

Fig. 17: Typical differential nonlinearity plot

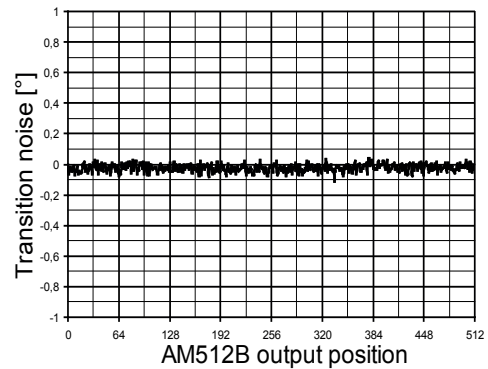

Fig. 18: Typical plot of transition noise

Parameter	Symbol	Typ.	Unit	Note
Maximum integral nonlinearity	$INL_{Max}$	$\pm 0.4$	deg	*
Maximum differential nonlinearity	$DNL_{Max}$	$\pm 0.4$	deg	0.1 deg RMS
Maximum transition noise	$TN_{Max}$	$\pm 0.2$	deg	0.03 deg RMS

\* If recommended magnet is used at optimum setup position.

## Recommended magnet

The AM512B can be supplied with a pre-selected magnet to ensure that optimum performance is achieved. Alternatively, magnets can be sourced from other suppliers but they must conform to the following guidelines to ensure that performance specifications can be achieved.

To select a suitable magnet it is important to know the properties of the sensors. Hall sensors are only sensitive to the perpendicular component of the magnetic flux density ( $B$ ). The AM512B has a Hall sensor array arranged in a circle with a radius of 2.4 mm. The sensors are located on the surface of the silicon.

Magnets must be cylindrical in shape and diametrically polarized. The main criterion for magnet selection is the modulation of the perpendicular component of magnetic flux density at the location of the sensors ( $B_n$ ).

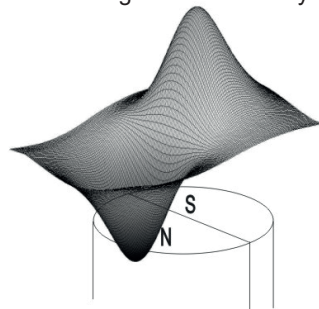

Fig. 19: Distribution of the perpendicular component of  $B$

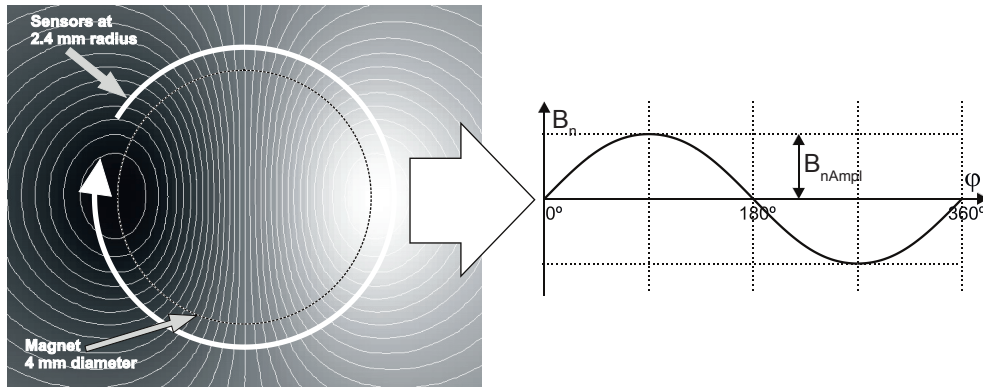

Fig. 20: Distribution of  $B_n$  and its modulation if the magnet is rotated through 360°

Parameter	Symbol	Min.	Typ.	Max.	Unit	Note
Amplitude of $B_n$ modulation	$B_{nAmpl}$		350		Gauss	*
Offset of $B_n$ modulation	$B_{nOffset}$	0		±15	Gauss	**

\* Typical value of  $B_{nAmpl}$  will give an analogue signal output with an amplitude of 1.2 V. The amplitude of the signal is proportional to the  $B_{nAmpl}$ .  
1 Tesla equals 10,000 Gauss.

\*\* Offset affects the integral nonlinearity if the magnet is not aligned correctly with respect to the chip.

We recommend that a magnet with the following parameters is used to provide the necessary modulation:

Parameter	Typ.	Unit	Note
Diameter	4	mm	
Length	4	mm	
Material	Sm2Co17		*
Material remanence	10.5	kGauss	
Temperature coefficient	-0.03	% / °C	
Curie temperature	720	°C	

\* Rare earth material magnets SmCo are recommended; however, NdFeB magnets can be used but they have different characteristics.

## Magnet position

The magnet can be placed below or above the device. The typical distance between the magnet and the sensors must be 2.45 mm for the recommended magnet.

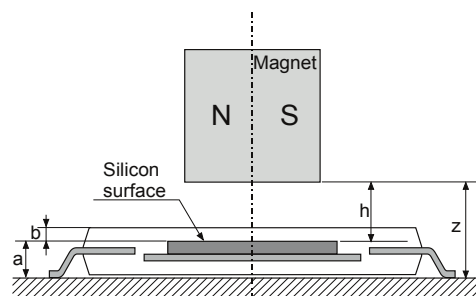

Fig. 21: Cross section of the AM512B with dimensions

Parameter	Symbol	Min.	Typ.	Max.	Unit	Note
Distance sensors – PCB plane	a		1.05		mm	
Distance sensors – chip surface	b		0.45		mm	
Distance sensors – magnet	h	2.25	2.45	2.65	mm	For recommended magnet
Distance magnet – PCB plane	z	3.3	3.5	3.7	mm	For recommended magnet

### Mounting instructions

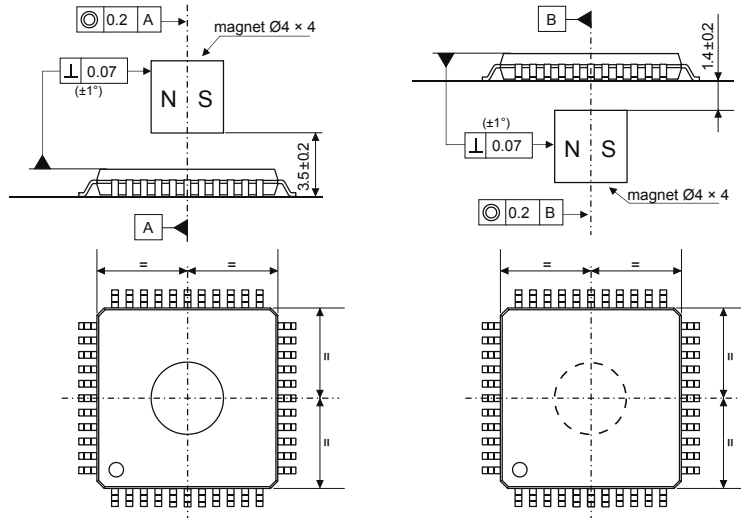

Fig. 22: Mounting instructions for magnet placed above the AM512B and magnet placed beneath the AM512B

### Magnet quality and the nonlinearity error

Each AM512B is optimized during the production to give best performance with an ideal magnet when perfectly aligned. An ideal magnet would have the polarization border exactly in the middle of the magnet. In reality this is impossible to achieve repeatably.

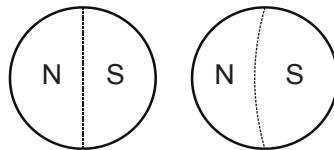

Fig. 23: Ideally polarized magnet and not ideally polarized magnet

If the polarization is not exactly in the middle of the magnet then the modulation of the magnetic field has an offset. The offset represents a mean value of  $B_n$  when the magnet is rotated through  $360^\circ$  and  $B_n$  is measured at 2.45 mm distance from the magnet surface and at 2.4 mm radius.

Offset will cause larger than normal integral nonlinearity errors if the AM512B placement is not in the center of the magnet rotation.

Figure 24 shows the additional integral nonlinearity error caused by misalignment of the AM512B for ideal and recommended magnets.

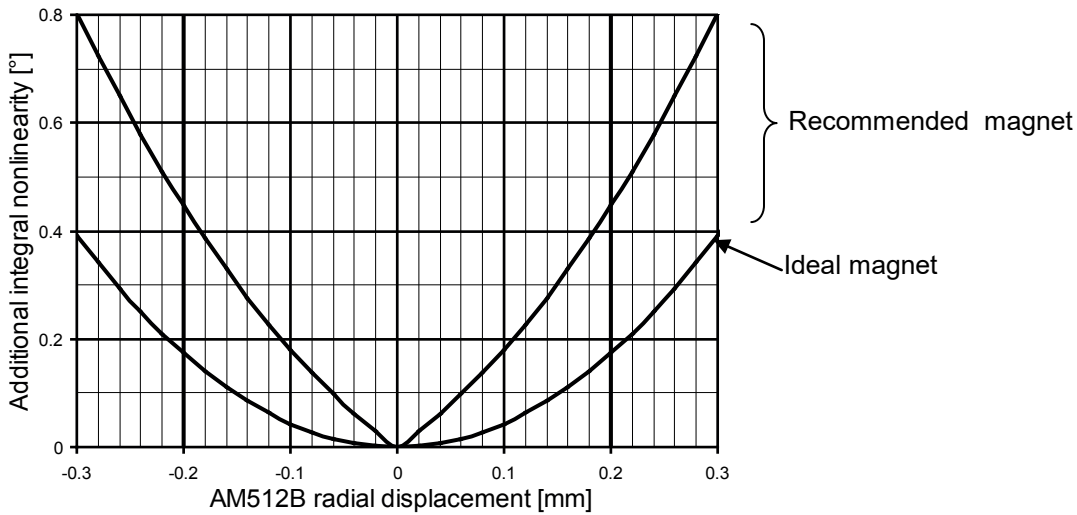

Fig. 24: Additional integral nonlinearity error caused by magnet displacement and quality

Total integral nonlinearity is the summation of integral nonlinearity and the additional integral nonlinearity error caused by magnet displacement.

### Error signal

Error signal can be used for alignment of the AM512B. The error signal is sinusoidal in shape with one period per turn. The amplitude of the error signal is proportional to the AM512B displacement. To achieve optimum setup the amplitude of the error signal should be minimized.

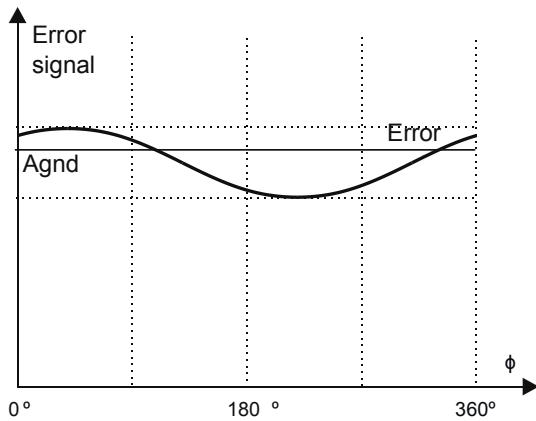

Fig. 25: Error signal shape

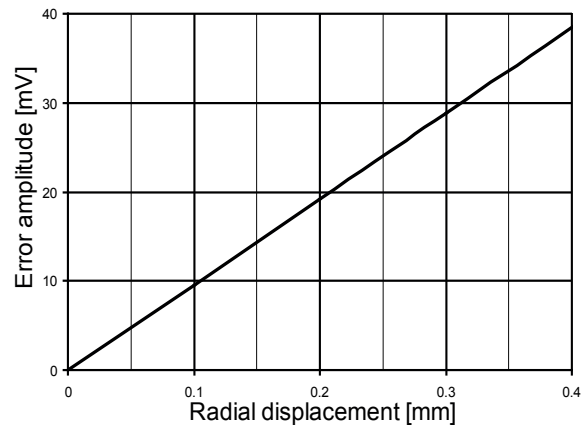

Fig. 26: Error signal amplitude

**Typical applications**

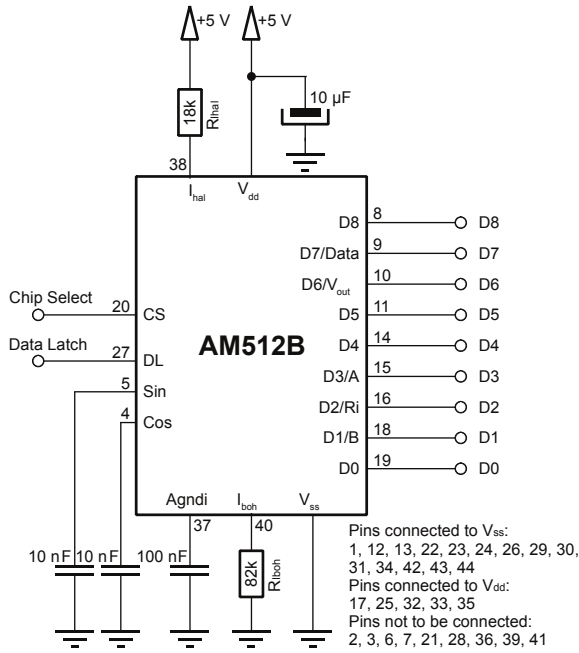

Fig. 27: Parallel output

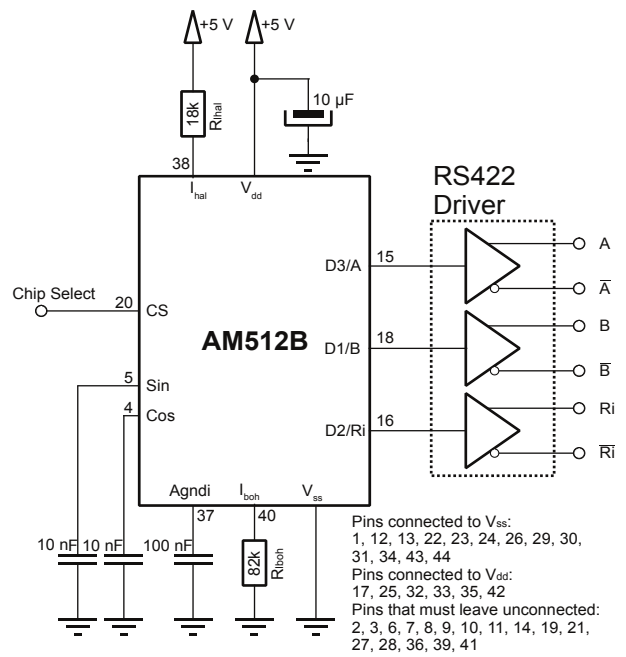

Fig. 28: Incremental output

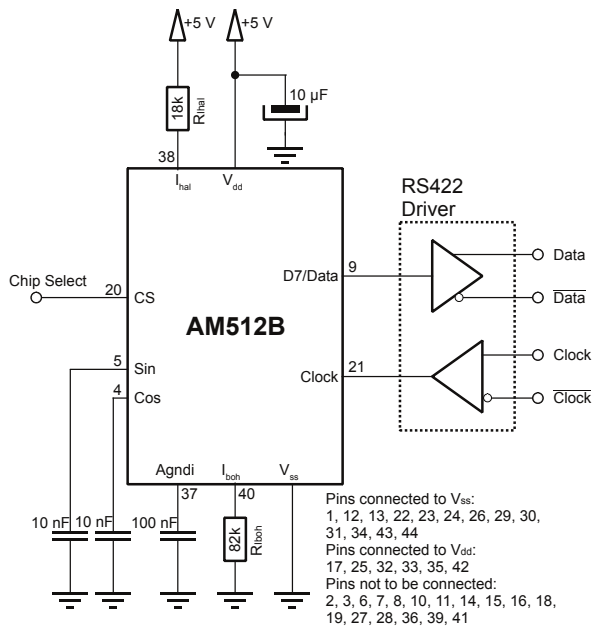

Fig. 29: SSI output

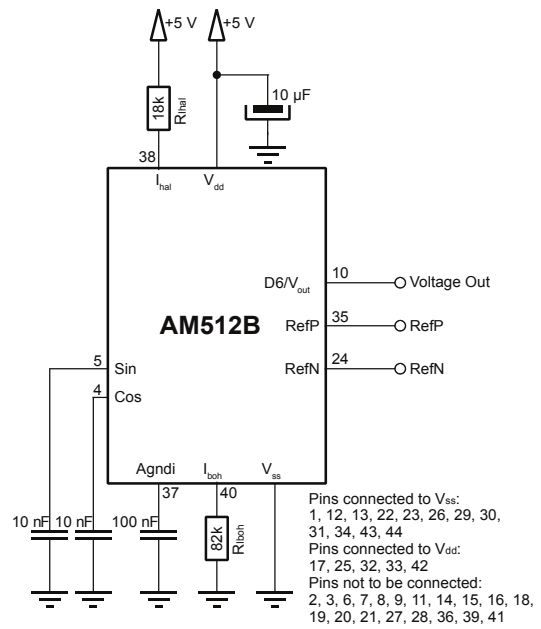

Fig. 30: Linear voltage output

NOTE: Incremental, SSI and linear outputs can be used simultaneously.

## Characteristics

All characteristics are measured at recommended conditions unless otherwise stated.

Recommended conditions:

Parameter	Symbol	Value	Unit	Note
Ambient temperature	$T_A$	22	°C	
Distance magnet-sensors	$h$	2.45	mm	
Signal amplitude	$A$	1.2	V	Min. 0.6 V, Max. 1.9 V
Power supply	$V_{dd}$	5	V	
Resistor for $I_{hal}$ setup	$R_{Ihal}$	18	k $\Omega$	
Resistor for $I_{boh}$ setup	$R_{Iboh}$	82	k $\Omega$	Do not change
Magnet				Recommended magnet

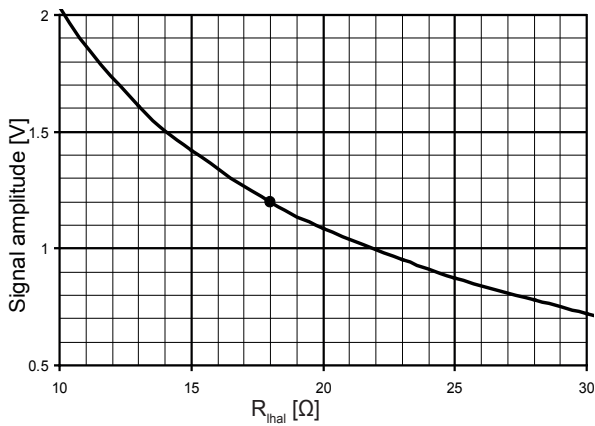

Fig. 31: Signal amplitude as a function of  $R_{Ihal}$

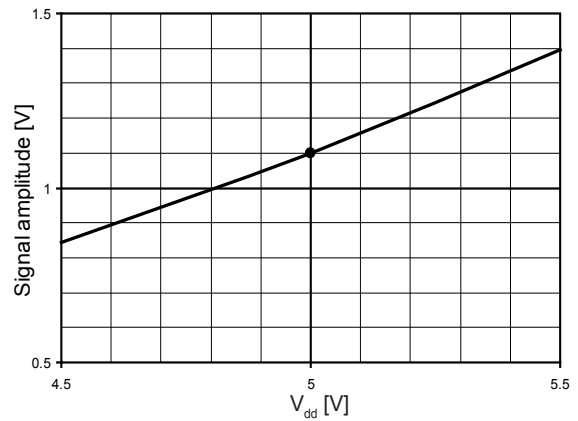

Fig. 32: Signal amplitude as a function of supply voltage

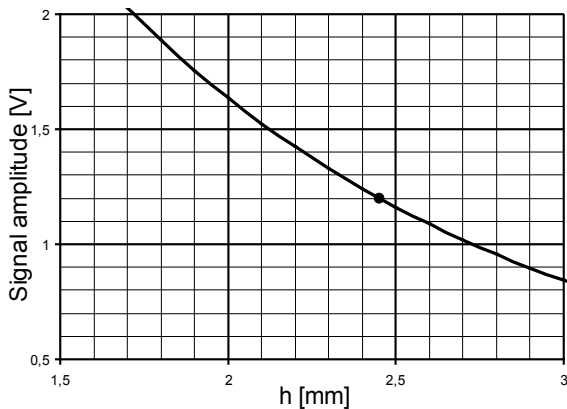

Fig. 33: Signal amplitude as a function of  $h$

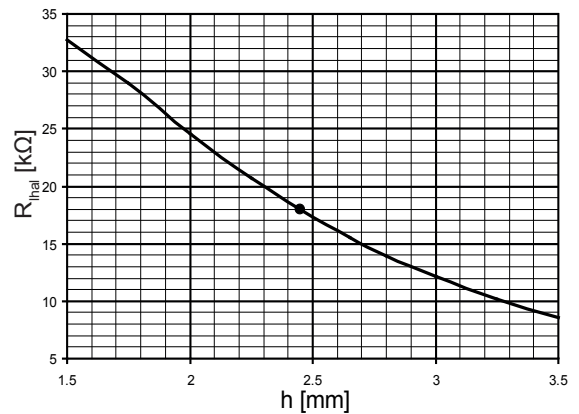

Fig. 34:  $R_{Ihal}$  to maintain signal amplitude at different  $h$

Data sheet  
**AM512BD01\_08**

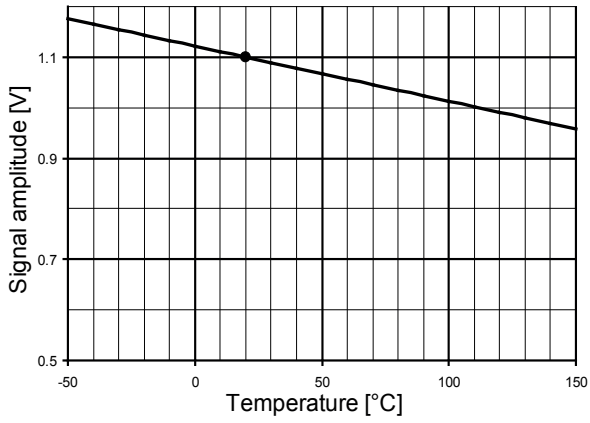

Fig. 35: Signal amplitude as a function of temperature

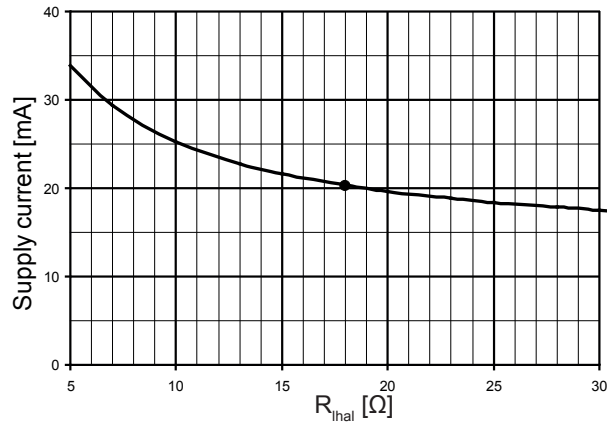

Fig. 36: Supply current as a function of R<sub>lhal</sub>

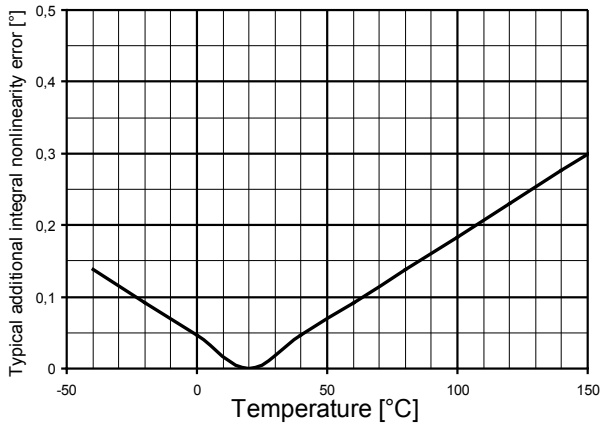

Fig. 37: Typical additional error as a function of temperature

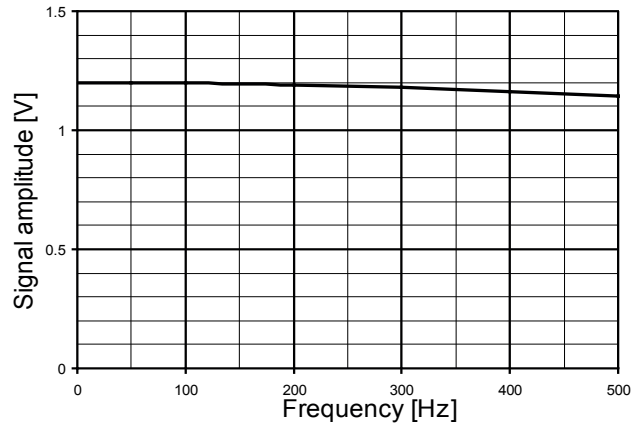

Fig. 38: Signal amplitude as a function of frequency

**LQFP44 package dimensions**

Dimensions:

Symbol	Minimal	Typ.	Maximum	Unit
A			1.6	mm
A1	0.05		0.15	mm
A2	1.35	1.40	1.45	mm
b	0.30	0.37	0.45	mm
c	0.09		0.20	mm
D	11.80	12.00	12.20	mm
D1	9.80	10.00	10.20	mm
D3		8.00		mm
E	11.80	12.00	12.20	mm
E1	9.80	10.00	10.20	mm
E3		8.00		mm
e		0.80		mm
L	0.45	0.60	0.75	mm
L1		1.00		mm
K	0	3.5	7	deg

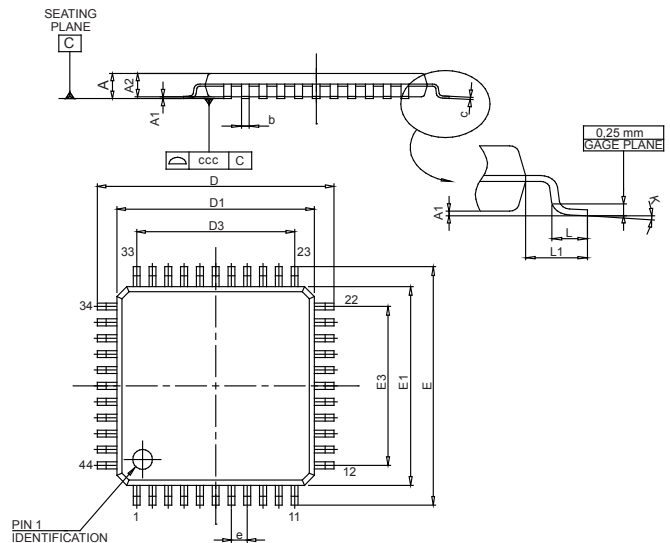

Fig. 39: Dimensional drawing



## AM512B ordering code

Linear voltage				
Clockwise	–	<b>VB</b>	<b>VC</b>	<b>VD</b>
	360°	180°	90°	45°
Counterclockwise	<b>VE</b>	<b>VF</b>	<b>VG</b>	<b>VH</b>
	360°	180°	90°	45°



NOTE: Order quantity must be a multiple of 160 (one tray).

NOTE: Magnet must be ordered separately! The angular magnetic encoder IC part number does not include a magnet.

NOTE: The chips are additionally laser marked to corresponding two letter code.

## 2. Magnet

Part number	Description
RMM44A2C00 	Diametrically polarized magnet Dimensions: Ø4 mm × 4 mm

## 3. Sample kits

Part number	Description
AM512VBKIT 	AM512B angular magnetic encoder IC with a magnet, delivered in an antistatic box. Outputs: Parallel, SSI, Incremental, Unbuffered Sine/Cosine.

NOTE: Maximum order quantity for AM512BKIT is 10 pcs. For larger quantities chip and magnet should be ordered separately.

**RMK1B evaluation board**

AM512B angular magnetic encoder IC on a PCB with all necessary components and a magnet, delivered in an antistatic box. RMK1B is evaluation board, not suitable for mass production.

Outputs: Parallel, SSI, Incremental, Linear Voltage, Unbuffered Sine/Cosine

**Connections**

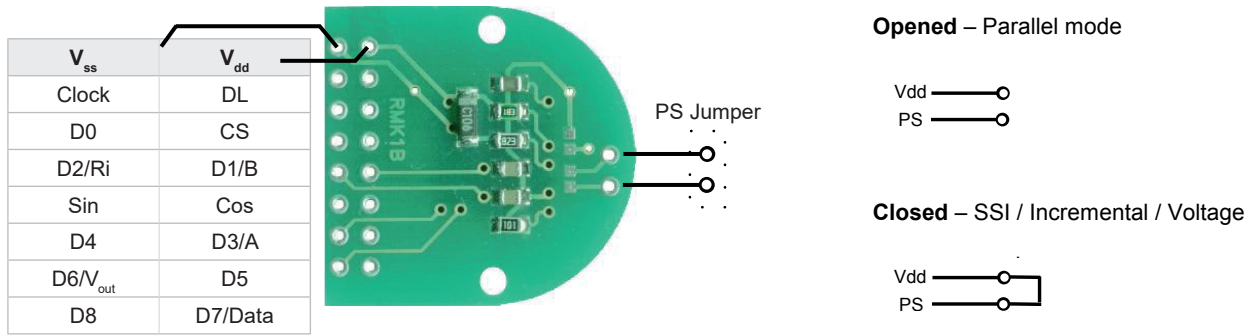

Fig. 40: RMK1B pin assignment

NOTE: The connection pads are on 100 mils grid.

**Dimensions**

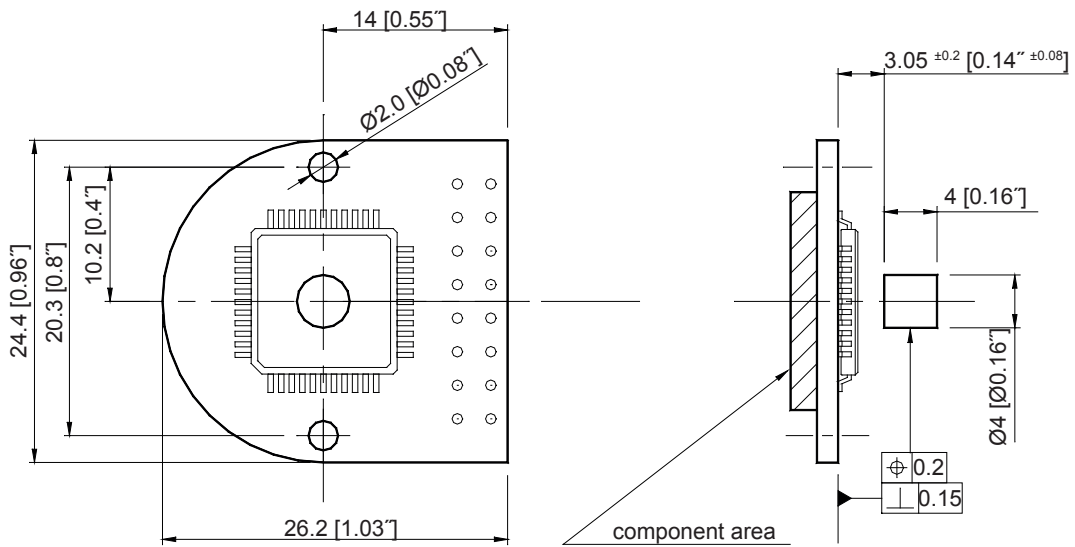

Fig. 41: Dimensional drawing with installation tolerances

For RMK1B sample request please visit [www.rls.si/am512b](http://www.rls.si/am512b).

## Head office

### RLS merilna tehnika d.o.o.

Poslovna cona Žeje pri Komendi  
Pod vrbami 2  
SI-1218 Komenda  
Slovenia

**T** +386 1 5272100

**F** +386 1 5272129

**E** [mail@rls.si](mailto:mail@rls.si)

**www.rls.si**

## Document issues

Issue	Date	Page	Corrections made
3	24. 4. 2007	General	New layout
		6	Changed clock timing in table for SSI output
		14	Corrected Mounting instructions diagram
		21	Added Document revisions section Changed contact information
4	14. 1. 2009	General	New layout
5	28. 10. 2015	General	New layout
6	17. 12. 2015	4	Moisture sensitivity level added
7	21. 3. 2016	1	Title and features amended
		12	Mounting instruction picture amended
8	27. 9. 2021	3	Text amended

This product is not designed or intended for use outside the environmental limitations and operating parameters expressly stated on the product's datasheet. Products are not designed or intended for use in medical, military, aerospace, automotive or oil & gas applications or any safety-critical applications where a failure of the product could cause severe environmental or property damage, personal injury or death. Any use in such applications must be specifically agreed to by seller in writing, and is subject to such additional terms as the seller may impose in its sole discretion. Use of products in such applications is at buyer's own risk, and buyer will indemnify and hold harmless seller and its affiliates against any liability, loss, damage or expense arising from such use. Information contained in this datasheet was derived from product testing under controlled laboratory conditions and data reported thereon is subject to the stated tolerances and variations, or if none are stated, then to tolerances and variations consistent with usual trade practices and testing methods. The product's performance outside of laboratory conditions, including when one or more operating parameters is at its maximum range, may not conform to the product's datasheet. Further, information in the product's datasheet does not reflect the performance of the product in any application, end-use or operating environment buyer or its customer may put the product to. Seller and its affiliates make no recommendation, warranty or representation as to the suitability of the product for buyer's application, use, end-product, process or combination with any other product or as to any results buyer or its customer might obtain in their use of the product. Buyer should use its own knowledge, judgment, expertise and testing in selecting the product for buyer's application, end-use and/or operating environment, and should not rely on any oral or written statement, representation, or samples made by seller or its affiliates for any purpose. EXCEPT FOR THE WARRANTIES EXPRESSLY SET FORTH IN THE SELLER'S TERMS AND CONDITIONS OF SALE, SELLER MAKES NO WARRANTY EXPRESS OR IMPLIED WITH RESPECT TO THE PRODUCT, INCLUDING ANY WARRANTY OF MERCHANTABILITY OR FITNESS FOR ANY PARTICULAR PURPOSE, WHICH ARE DISCLAIMED AND EXCLUDED. All sales are subject to seller's exclusive terms and conditions of sale which, where the seller is (a) RLS merilna tehnika d.o.o., are available at <https://www.rls.si/customer-service>, (b) Renishaw, Inc., are available at <http://www.renishaw.com/Shop/legal/en/-42186>, or (c) another person, are available on request, and in each case, are incorporated herein by reference, and are the exclusive terms of sale. No other terms and conditions apply. Buyer is not authorized to make any statements or representations that expand upon or extend the environmental limitations and operating parameters of the products, or which imply permitted usage outside of that expressly stated on the datasheet or agreed to in writing by seller.

RLS merilna tehnika d.o.o. has made considerable effort to ensure the content of this document is correct at the date of publication but makes no warranties or representations regarding the content. RLS merilna tehnika d.o.o. excludes liability, howsoever arising, for any inaccuracies in this document. © 2021 RLS d.o.o.