

GE Fanuc Automation
Computer Numerical Control Products

Ladder-III

Operator's Manual, GFZ-66234EN/05

December 2004



Warnings, Cautions, and Notes as Used in this Publication

Warning

Warning notices are used in this publication to emphasize that hazardous voltages, currents, temperatures, or other conditions that could cause personal injury exist in this equipment or may be associated with its use.

In situations where inattention could cause either personal injury or damage to equipment, a Warning notice is used.

Caution

Caution notices are used where equipment might be damaged if care is not taken.

Note

Notes merely call attention to information that is especially significant to understanding and operating the equipment.

This document is based on information available at the time of its publication. While efforts have been made to be accurate, the information contained herein does not purport to cover all details or variations in hardware or software, nor to provide for every possible contingency in connection with installation, operation, or maintenance. Features may be described herein which are not present in all hardware and software systems. GE Fanuc Automation assumes no obligation of notice to holders of this document with respect to changes subsequently made.

GE Fanuc Automation makes no representation or warranty, expressed, implied, or statutory with respect to, and assumes no responsibility for the accuracy, completeness, sufficiency, or usefulness of the information contained herein. No warranties of merchantability or fitness for purpose shall apply.

The following are trademarks of GE Fanuc Automation, Inc.

Alarm Master	Genius	ProLoop	Series Six
CIMPLICITY	Helpmate	PROMACRO	Series Three
CIMPLICITY 90-ADS	Logicmaster	PowerMotion	VersaMax
CIMSTAR	Modelmaster	PowerTRAC	VersaPoint
Field Control	Motion Mate	Series 90	VersaPro
GEnet	PACSystems	Series Five	VuMaster
	Proficy	Series One	Workmaster

SAFETY PRECAUTIONS

This manual includes safety precautions for protecting the user and preventing damage to the machine. Precautions are classified into Warnings and Cautions according to their bearing on safety. Also, supplementary information is described as Notes. Read the Warnings, Cautions, and Notes thoroughly before attempting to use the machine.

 **WARNING**

Applied when there is a danger of the user being injured or when there is a danger of both the user being injured and the equipment being damaged if the approved procedure is not observed.

 **CAUTION**

Applied when there is a danger of the equipment being damaged, if the approved procedure is not observed.

NOTE

Notes is used to indicate supplementary information other than Warnings and Cautions.

- Read this manual carefully, and store it in a safe place.

1.1 GENERAL WARNINGS AND CAUTIONS

The following warnings and note describe precautions on handling CNCs, which must be observed to ensure safety when using machines equipped with a CNC.

WARNING

- 1 Before operating the machine, thoroughly check the entered data. Operating the machine with incorrectly specified data may result in the machine behaving unexpectedly, possibly causing damage to the workpiece and/or machine itself, or injury to the user.
- 2 The parameters for the CNC and PMC are factory-set. Usually, there is no need to change them. When, however, there is no alternative other than to change a parameter, ensure that you fully Failure to set a parameter correctly may result in the machine behaving unexpectedly, possibly causing damage to the workpiece and/or machine itself, or injury to the user.

NOTE

Command programs, parameters, and variables are stored in nonvolatile memory in the CNC. Generally, the contents of memory are not lost by a power on/off operation. However, the contents of memory may be erased by mistake, or important data in nonvolatile memory may have to be erased upon recovering from a failure.

To enable the restoration of data as soon as possible if such a situation arises, always make a backup of the data in advance.

1.2 WARNINGS AND NOTES RELATING TO FANUC LADDER-III

Warnings and notes relating to FANUC LADDER-III appear in this manual. Before using the software, read this manual thoroughly and take time to read the Warnings, Cautions, and Notes in this manual carefully.

In addition, "READ THE FOLLOWING:" which appears in the next section, summarizes the note to be kept in mind when FANUC LADDER-III is used, which is not described in the chapters in this manual. Before using this software, also read this part.

1.3 READ THE FOLLOWING:

The following summarizes the points that the user should keep in mind when using FANUC LADDER-III. Before using FANUC LADDER-III, read the following:

**CAUTION**

In this manual we have tried as much as possible to describe all the various matters.

However, we cannot describe all the matters which must not be done, or which cannot be done, because there are so many possibilities.

Therefore, matters which are not especially described as possible in this manual should be regarded as "impossible"

PREFACE

Renaming

This software has been renamed as follows:

Old name: FAPT LADDER-III

New name: FANUC LADDER-III

Any specifications of this software have not been changed (they are same as of the product with the old name).

If the old name is displayed by any FANUC PMC programming tool, read the old name as referring to the new name.

NOTE

- 1 If FAPT LADDER-III is installed, be sure to uninstall the software, then install FANUC LADDER-III.
- 2 Both of FAPT LADDER-III and FANUC LADDER-III cannot be installed on the same personal computer.

Thank you for purchasing FANUC LADDER-III
(Specification : A08B-9210-J505).

FANUC LADDER-III is a programming system for developing sequence programs for FANUC PMCs.

This software runs under the Microsoft® Windows® environment. This manual does not cover common basic Windows operations. If you are a beginner to Windows, read the Windows manual first to learn the basic Windows operations.

This manual describes the programming system-specific items including the methods of installing, starting, and using this software. For details on how to create sequence programs for FANUC PMCs and how to operate PMCs, refer to the following manuals:

- FANUC PMC MODEL PA1/PA3/SA1/SA2/SA3/SA5/SB/SB2/SB3/SB4/SB5/SB6/SB7/SC/SC3/SC4/NB/NB2/NB6 Ladder Language Programming Manual (B-61863E)
- FANUC Series 30i/300i/300is-MODEL A
FANUC Series 31i/310i/310is-MODEL A5
FANUC Series 31i/310i/310is-MODEL A
FANUC Series 32i/320i/320is-MODEL A
PMC Programming Manual (B-63983EN)

Read this manual thoroughly to ensure the correct use of FANUC LADDER-III.

NOTE

This software you purchased can be used on a single computer. When using this software on more than one computer, you must be licensed to use as many copies of this software as the number of the computers being used, even if you are not running this software on multiple computers at the same time. You may make one copy of this software for backup or archiving purposes.

Copyright to this software is reserved by FANUC. You must not transfer, lend, sell, distribute, lease, or rent this software to a third party.

Microsoft and Windows are registered trademarks of Microsoft Corporation in the United States of America.

1.1 FEATURES OF FANUC LADDER-III

This software has the following features:

Features

This software provides a Windows-based environment for developing sequence programs for FANUC PMCs, therefore providing the user with easy-to-use operating environment.

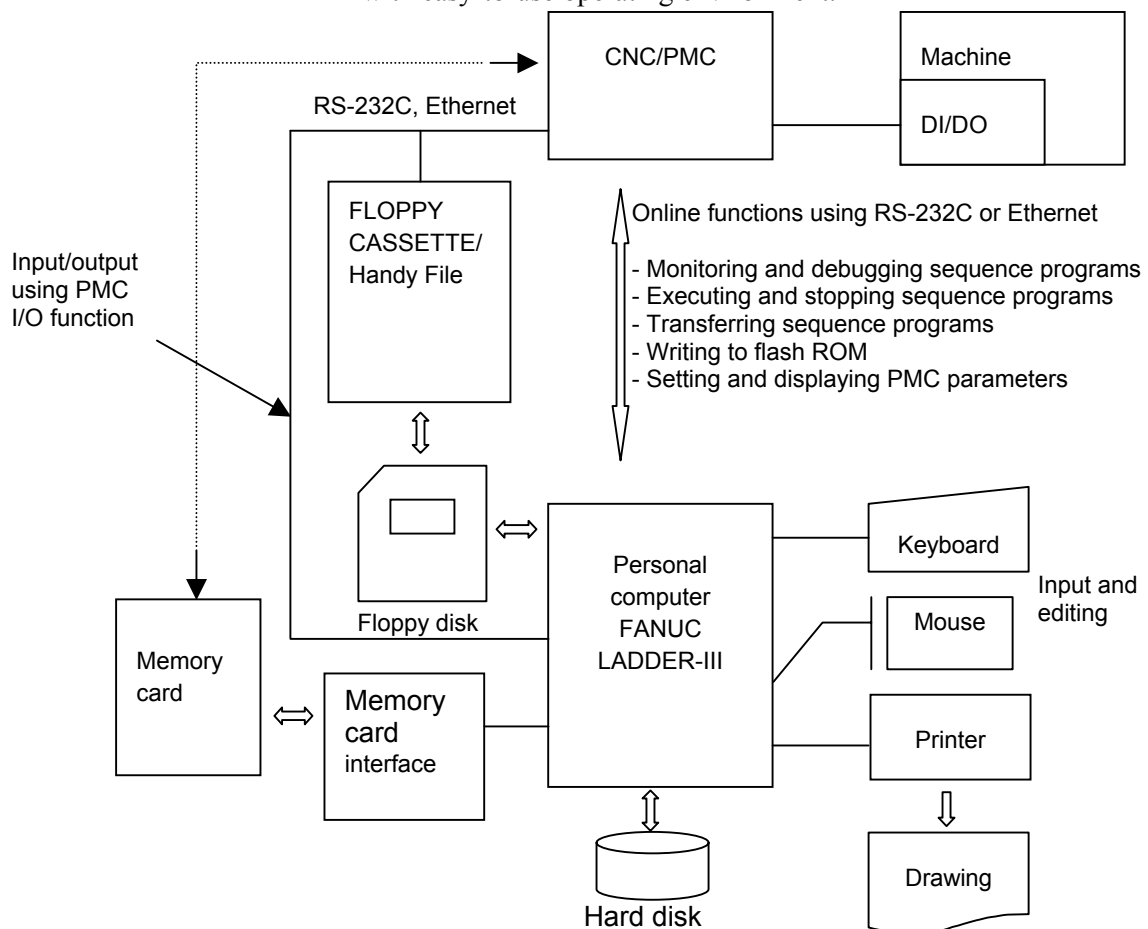

Outline Diagram

NOTE

- 1 The specifications of the online functions using the RS-232C or Ethernet interface vary depending on the PMC model being used. With some PMC models, these functions are not available. For details on the functions, refer to the relevant PMC Programming Manual.
- 2 Multiple FANUC LADDER-III programs can be started at the same time. Multiple FANUC LADDER-III programs cannot be connected to one PMC at the same time. For one PC, FANUC LADDER-III can be connected to a maximum of four PMCs when using RS-232-C, while it can be connected to a maximum of 10 PMCs when using Ethernet.
- 3 For Ethernet, I/O operations that use [HOST] of the PMC I/O function cannot be performed.

- Main functions
 - Inputting, displaying, editing, and outputting sequence programs
 - Monitoring and debugging sequence programs (Displaying the signal status, alarms, and PMC status, and ladder diagram online monitoring)
 - Setting and displaying PMC parameters
 - Executing and stopping sequence programs
 - Transfer to and from the PMC (RAM)
 - Writing to flash ROM
 - Printing sequence programs
- Supported PMC models
 PMC-NB/NB2/NB6/PA3/SA1/SA3/SA5/SB3/SB4/SB5/SB6/SB7/SC3/SC4
 30i-A PMC / 31i-A PMC / 32i-A PMC
- PMC models and supported functions
 The following table lists the available functions for each PMC model:

PMC model	Function								
	Multi-path PMC	Multiple comments	Extended function	Step sequence program	Online function	Offline function	I/O device		
							PMC	Handy File	Memory card
30i-A PMC	A	A	B	B	A	A	B	A	A
30i-A PMC(EXT)	A	A	A ^{*4}	B	A	A	B	A	A
31i-A PMC	A	A	B	B	A	A	B	A	A
31i-A PMC(EXT)	A	A	A ^{*4}	B	A	A	B	A	A
32i-A PMC	A	A	B	B	A	A	B	A	A
32i-A PMC(EXT)	A	A	A ^{*4}	B	A	A	B	A	A
SA1	B	B	B	B	B	A	A	A	C
SA3	B	B	B	B	B	A	A	A	C
SA5	B	B	B	B	A	A	A	A	C
SB3	B	B	B	B	C ^{*1}	A	A	A	C
SB4	B	B	B	B	C ^{*1}	A	A	A	A
SB4(STEP SEQ)	B	B	B	A	C ^{*1}	A	A	A	A
SB5	B	B	B	B	A	A	A	A	A
SB6	B	B	B	B	A	A	A	A	A
SB6(STEP SEQ)	B	B	B	A	A	A	A	A	A
SB7	B	B	B	B	A	A	B	A	A
SB7(STEP SEQ)	B	B	B	A	A	A	B	A	A
SC3	B	B	B	B	C ^{*1}	A	A	A	C
SC4	B	B	B	B	C ^{*1}	A	A	A	A
SC4(STEP SEQ)	B	B	B	A	C ^{*1}	A	A	A	A
PA3	B	B	B	B	C ^{*2}	A	A	A	A
NB	B	B	B	B	C ^{*3}	A	A	A	A
NB2	B	B	B	B	C ^{*3}	A	A	A	A
NB2(STEP SEQ)	B	B	B	A	C ^{*3}	A	A	A	A
NB6	B	B	B	B	A	A	C	C	A

A : Available, B: Not available

C : Available under certain conditions (The supported functions vary depending on the CNC and PMC series and edition. Refer to the following Note.)

NOTE

- *1 • Available when the PMC software series and edition are 4066/12, 4068/11, or later and the CNC software series and edition are B0A1/23, B1A1/20, BDA1/12, BEA1/12, or later.
- *2 • Available when the PMC software series and edition are 4074/01 or later. Not available with the 4075 series. The supported CNC software series and editions are 8838/01, 883C/02, 8839/01, 8834/07, 883E/03, and later.
 - Available when the PMC software series and edition are 4078/04 or later. The supported CNC software series and editions are 8880/11 and later.
- *3 • Available when the PMC software series and edition are 4048/10, 4068/08, or later.
 - Not available with the 4046 or 4047 PMC software series.
- *4 • Available when the PMC software series and edition are 406N/13 or later.
 - In extended function, symbol is maximum 40 characters. Comment is maximum 255 characters and 4 kinds available for multi-comment. And local symbol and automatic address assignment are supported.

1.2 CHECKING THE PACKAGE CONTENTS

The package contains the following:

- CD-ROM disks
FANUC LADDER-III (A08B-9210-J505)

NOTE

You must read the release note (READMEJ.TXT) on the “\Disk1 folder” of the product package. The release note provides detailed information on the package and information not included in the Operator's Manual.

1.3 ORGANIZATION OF THIS MANUAL

This manual is organized as follows:

SAFETY PRECAUTIONS

Describes general precautions that must be observed to ensure the safe use of this software.

PREFACE

Briefly describes the main features of this software. Also describes how to use this manual and other information to understand the use of this software.

1. SETUP

Describes the software operating environment and explains how to set up this software to ready it for use.

2. BASICS

Describes the basic items that the user should understand before using this software.

3. CREATING AND EDITING SEQUENCE PROGRAMS

Describes how to create and edit sequence programs.

4. PRINTING SEQUENCE PROGRAMS

Describes how to print sequence programs.

5. COMPILATION AND DECOMPILATION

Describes how to compile and decompile programs and also describes ladder program protection by password.

6. MNEMONIC EDITING

Describes conversion to mnemonic files and the mnemonic file format.

7. INPUT/OUTPUT

Describes input/output of sequence programs (loading sequence programs from the PMC and storing them into the PMC).

8. EXECUTING AND STOPPING SEQUENCE PROGRAMS

Describes how to execute and stop sequence programs.

9. DIAGNOSIS

Describes the online diagnosis functions including ladder monitoring, signal tracing, and signal analysis.

10. COMMAND LINE EXECUTION FUNCTION

11. EXTENDED SYMBOL/COMMENT FUNCTION

12. CONVERTING SEQUENCE PROGRAMS

Describes how to convert DOS sequence programs to Windows sequence programs.

13. ERROR MESSAGES

Describes the error messages displayed by this software.

APPENDIX

Provides information that is to be read as necessary.

1.4 NOTATION CONVENTIONS IN THIS MANUAL

This manual uses the following notation and conventions:

- Menus, commands, and screens

Notation example	Explanation
[File] menu	Menu names appear in brackets ([]).
[Setting...]	Command names appear in brackets ([]).
[Program List] screen	As the name of a screen, the title displayed on the title bar of the screen appears in brackets ([]).
<OK> button	Command buttons on the screen appear in angle brackets (< >).

- Keys and their operation

Notation example	Explanation
[Enter] key	Key names are indicated in brackets ([]).
[Ctrl]+[Tab] key	When two or more keys are held down at the same time by pressing them sequentially, the keys are connected using "+", as shown on the left.
Direction keys	The [→], [←], [↑], and [↓] keys are collectively called direction keys.

- Mouse operations

Example of notation	Explanation
Click	To press and then immediately release a mouse button.
Double-click	To click a mouse button twice in rapid succession.
Drag	To move the mouse while holding down a mouse button, and then releasing the button at a desired position.

- Folders

Directories and folders are collectively referred to as folders.

- PMC models
In this manual, the PMC models are abbreviated as follows:

PMC Model Abbreviations

Abbreviation	PMC model
30i-A PMC	PMC for Series 30i-A (1st-path PMC)
30i-A PMC(2nd)	PMC for Series 30i-A (2nd-path PMC)
30i-A PMC(3rd)	PMC for Series 30i-A (3rd-path PMC)
30i-A PMC(DCS)	PMC for Series 30i-A (Dual check safety)
30i-A PMC(EXT)	PMC for Series 30i-A (1st-path PMC, Extended function)
30i-A PMC(2nd,EXT)	PMC for Series 30i-A (2nd-path PMC, Extended function)
30i-A PMC(3rd,EXT)	PMC for Series 30i-A (3rd-path PMC, Extended function)
30i-A PMC(DCS,EXT)	PMC for Series 30i-A (Dual check safety, Extended function)
31i-A PMC	PMC for Series 31i-A (1st-path PMC)
31i-A PMC(2nd)	PMC for Series 31i-A (2nd-path PMC)
31i-A PMC(3rd)	PMC for Series 31i-A (3rd-path PMC)
31i-A PMC(DCS)	PMC for Series 31i-A (Dual check safety)
31i-A PMC(EXT)	PMC for Series 31i-A (1st-path PMC, Extended function)
31i-A PMC(2nd,EXT)	PMC for Series 31i-A (2nd-path PMC, Extended function)
31i-A PMC(3rd,EXT)	PMC for Series 31i-A (3rd-path PMC, Extended function)
31i-A PMC(DCS,EXT)	PMC for Series 31i-A (Dual check safety, Extended function)
32i-A PMC	PMC for Series 32i-A (1st-path PMC)
32i-A PMC(2nd)	PMC for Series 32i-A (2nd-path PMC)
32i-A PMC(3rd)	PMC for Series 32i-A (3rd-path PMC)
32i-A PMC(DCS)	PMC for Series 32i-A (Dual check safety)
32i-A PMC(EXT)	PMC for Series 32i-A (1st-path PMC, Extended function)
32i-A PMC(2nd,EXT)	PMC for Series 32i-A (2nd-path PMC, Extended function)
32i-A PMC(3rd,EXT)	PMC for Series 32i-A (3rd-path PMC, Extended function)
32i-A PMC(DCS,EXT)	PMC for Series 32i-A (Dual check safety, Extended function)
PMC-SA1	FANUC PMC-MODEL SA1
PMC-SA3	FANUC PMC-MODEL SA3
PMC-SA5	FANUC PMC-MODEL SA5
PMC-SB3	FANUC PMC-MODEL SB3
PMC-SB4	FANUC PMC-MODEL SB4
PMC-SB5	FANUC PMC-MODEL SB5
PMC-SB6	FANUC PMC-MODEL SB6
PMC-SB7	FANUC PMC-MODEL SB7
PMC-SC3	FANUC PMC-MODEL SC3
PMC-SC4	FANUC PMC-MODEL SC4
PMC-PA3	FANUC PMC-MODEL PA3
PMC-QC	FANUC PMC-MODEL QC
PMC-NB	FANUC PMC-MODEL NB
PMC-NB2	FANUC PMC-MODEL NB2
PMC-NB6	FANUC PMC-MODEL NB6

TABLE OF CONTENTS

SAFETY PRECAUTIONS	s-1
PREFACE	p-1
1 SETUP	1
1.1 OPERATING ENVIRONMENT	2
1.2 INSTALLATION AND UNINSTALLATION	3
1.2.1 Installation.....	3
1.2.2 Uninstallation	9
2 BASICS	11
2.1 START AND END	12
2.1.1 Starting FANUC LADDER-III	12
2.1.2 Starting FANUC LADDER-III (Online Connection)	12
2.1.3 Terminating FANUC LADDER-III	12
2.2 WINDOW NAMES AND FUNCTIONS	13
2.2.1 Main Menu	14
2.2.2 Toolbar	16
2.2.3 Edit Toolbar.....	17
2.2.4 Soft Keys	17
2.2.5 Status Bar	17
2.2.6 Status Monitor	17
2.3 DISPLAYING VERSION INFORMATION	18
3 CREATING AND EDITING SEQUENCE PROGRAMS	19
3.1 SEQUENCE PROGRAMS.....	20
3.1.1 Procedure for Creating Sequence Programs.....	20
3.1.2 PMC Programming Method	24
3.1.3 Work Folders and Online Program Files.....	25
3.1.4 Device Selection.....	26
3.2 CREATING NEW PROGRAMS	28
3.2.1 Procedure.....	28
3.3 OPENING EXISTING PROGRAMS.....	31
3.3.1 Procedure.....	31
3.3.2 Opening Programs Opened by Another User	32
3.3.3 Opening Programs with the Read-only Attribute.....	34
3.3.4 Program Importing Function from Memory Card Files	34

3.4	EDITING TITLES	36
3.4.1	Procedure.....	36
3.5	EDITING LADDER DIAGRAMS.....	38
3.5.1	Preparing for Offline Editing	38
3.5.2	Preparing for Online Editing.....	39
3.5.3	Method of Displaying the Ladder Diagram Editing Screen.....	40
3.5.4	Changing Ladder Programs.....	46
3.5.5	Inserting Ladders from the Edit Window into a Ladder Program.....	49
3.5.6	Entering Basic Instructions	51
3.5.7	Entering Function Instructions	55
3.5.8	Entering Horizontal Lines	59
3.5.9	Entering and Deleting Vertical Lines.....	60
3.5.10	Adding Ladder Subprograms	61
3.5.11	Deleting Ladder Subprograms.....	62
3.5.12	Editing Net Comments	64
3.5.13	Deleting Net Comments	66
3.5.14	Adding Page Breaks.....	67
3.5.15	Deleting Page Breaks	68
3.5.16	Deleting Nets.....	69
3.5.17	Search	70
3.5.17.1	Context menu.....	73
3.5.17.2	Soft key.....	74
3.5.18	Collective Display	75
3.5.18.1	Setting collective display extraction conditions	75
3.5.18.2	Executing collective display.....	79
3.5.18.3	Modifying collective display extraction conditions.....	80
3.5.18.4	Deleting collective display extraction conditions.....	81
3.5.19	Setting Ladder Display.....	82
3.5.20	Changing Signal Addresses and Function Instruction Parameters in the Display Window	87
3.5.21	Changing Contacts and Coils in the Display Window	88
3.5.22	Checking the Number of Program Steps	89
3.5.23	Replace	91
3.5.24	Changing Ladder Programs on the Display Window.....	94
3.5.24.1	Changing the ladder editing mode.....	94
3.5.24.2	Inserting an edit line	95
3.5.24.3	Entering basic instructions.....	96
3.5.24.4	Entering function instructions.....	100
3.5.24.5	Entering horizontal lines.....	104

	3.5.24.6	Entering and deleting vertical lines	105
3.5.25		Deleting Symbol or Comment Data	106
3.5.26		Undo / Redo	107
	3.5.26.1	Setting the maximum number of undo operations	108
3.5.27		Ladder Diagram is Outputted to the Text File.....	109
	3.5.27.1	Procedure.....	109
	3.5.27.2	The example of an output file.....	112
	3.5.27.3	Ladder diagram without the net number is output to the text file.....	113
3.5.28		Automatic Input of Timer, Counter, Rising / Falling-Edge Numbers.....	114
	3.5.28.1	Automatic input of the TMR parameter of a functional instruction	116
	3.5.28.2	Automatic input of the CTR parameter of a functional instruction	117
3.6		EDITING STEP SEQUENCES	118
3.6.1		Step Sequence Configuration	122
3.6.2		Entering Steps	129
3.6.3		Entering Transitions	130
3.6.4		Beginning of Selective Branch.....	131
3.6.5		End of Selective Branch	131
3.6.6		Beginning of Parallel Branch	132
3.6.7		End of Parallel Branch	132
3.6.8		Specifying Jump-to Label	133
3.6.9		Specifying Label Jump.....	134
3.6.10		Checking Syntax	135
3.6.11		Adding Step Sequence Subprograms	136
3.6.12		Deleting Step Sequence Subprograms.....	137
3.6.13		Search.....	138
3.7		EDITING SYMBOLS AND COMMENTS	139
3.7.1		Symbol and Comment Data.....	139
3.7.2		Procedure.....	141
3.7.3		Toolbar	144
3.7.4		Context Menu	144
3.8		EDITING MESSAGES	145
3.8.1		Procedure.....	145
3.8.2		Models and Quantity of Usable Characters.....	147
3.8.3		Memory Addresses Required to Display Messages	147
3.8.4		New Line Character, Numeric Data	148
3.8.5		Tool Bar.....	150
3.8.6		Status Bar	151
3.8.7		Shortcut keys.....	151

3.9	EDITING I/O MODULE ASSIGNMENT	152
3.9.1	Procedure.....	152
3.9.2	Tool bar	154
3.9.3	Shortcut Keys	154
3.10	EDITING SYSTEM PARAMETERS.....	155
3.10.1	Procedure.....	155
3.11	SAVING PROGRAMS	160
3.11.1	Procedure.....	160
3.11.2	About the Deletion of the Unused Net Comment.....	161
3.12	SAVING PROGRAMS WITH NAMES	162
3.12.1	Procedure.....	162
3.13	CLOSING PROGRAMS.....	163
3.13.1	Procedure.....	163
3.14	IMPORTING PROGRAMS	164
3.14.1	Procedure.....	164
3.14.2	Import of the External Symbol File.....	170
3.15	EXPORTING PROGRAMS.....	172
3.15.1	Procedure.....	172
3.15.2	Export of the External Symbol File.....	176
3.16	OPENING MOST RECENTLY USED PROGRAMS	179
3.17	CHECKING DUPLICATE COIL	180
3.17.1	Duplicate Coil Screen.....	180
3.18	PMC TYPE CHANGED AND SAVE	184
4	PRINTING SEQUENCE PROGRAMS	187
4.1	PRINTING TITLES	188
4.1.1	Procedure.....	188
4.2	PRINTING LADDER DIAGRAMS	190
4.2.1	Procedure.....	190
4.3	PRINTING STEP SEQUENCES.....	193
4.3.1	Procedure.....	193
4.4	PRINTING SYMBOLS AND COMMENTS	195
4.4.1	Procedure.....	195
4.5	PRINTING MESSAGES	198
4.5.1	Procedure.....	198
4.6	PRINTING I/O MODULE ASSIGNMENT	200
4.6.1	Procedure.....	200
4.7	PRINTING SYSTEM PARAMETERS	202

4.7.1	Procedure.....	202
4.8	PRINTING CROSS-REFERENCES	204
4.8.1	Procedure.....	204
4.9	PRINTING BIT ADDRESS MAPS.....	208
4.9.1	Procedure.....	208
4.10	SETTING UP COMMON OPTIONS	210
4.10.1	Procedure.....	210
4.11	SAVING AND READING OPTION FILE	211
4.11.1	Procedure.....	211
4.12	SETTING UP PRINTER	214
4.12.1	Procedure.....	214
4.12.2	Setting up Pages	215
4.12.3	Setting Property.....	220
5	COMPILATION AND DECOMPILATION.....	221
5.1	COMPILATION	222
5.2	DECOMPILATION	227
5.3	AUTOMATIC COMPILATION AND DECOMPILATION.....	233
5.4	PROTECTING LADDER PROGRAMS BY PASSWORDS	234
5.4.1	Partial Protect Functions	236
5.5	AUTOMATIC NUMBERING OF TMRB/ TMRBF/ DIFU/ DIFD.....	238
6	MNEMONIC EDITING	240
6.1	CONVERTING SOURCE PROGRAMS TO MNEMONIC FILES.....	241
6.1.1	Converts to the External Symbol File	243
6.2	CONVERTING MNEMONIC FILES TO SOURCE PROGRAMS.....	245
6.2.1	Addition of Symbol/Comment and Net Comment	247
6.3	MNEMONIC FILE FORMAT	249
6.4	MNEMONIC FILE SAMPLE.....	253
6.4.1	Single Format	253
6.4.1.1	Parameter	253
6.4.2	Title	262
6.4.2.1	Symbol and comment	262
6.4.2.2	Ladder.....	263
6.4.2.3	Message	264
6.4.2.4	I/O module.....	264
6.4.3	ALL format.....	265
6.5	CONVERTING STEP SEQUENCE PROGRAMS TO MNEMONIC FILES	266
6.6	MNEMONIC OPTIONS.....	267

6.7	FORMAT OF EXTERNAL SYMBOL FILE	269
6.7.1	Option.....	270
6.7.2	Sample of an External Symbol File.....	270
6.7.3	Operation to Import from CSV-file.....	271
6.7.3.1	Batch Command Execution	272
7	INPUT/OUTPUT	273
7.1	SETTING UP COMMUNICATION	274
7.1.1	[Communication] Dialog Box	274
7.1.1.1	Setting up RS-232C	274
7.1.1.2	Setting up Ethernet	276
7.1.2	[Option] Dialog Box.....	278
7.1.2.1	Setting up RS-232C	278
7.1.2.2	Setting up Ethernet	279
7.2	LOADING SEQUENCE PROGRAMS FROM THE PMC (DURING DISCONNECTION WITH THE PMC).....	280
7.2.1	Procedure.....	280
7.3	LOADING SEQUENCE PROGRAMS FROM THE PMC (DURING CONNECTION WITH THE PMC).....	287
7.3.1	Procedure.....	287
7.4	STORING SEQUENCE PROGRAMS IN THE PMC (DURING CONNECTION WITH THE PMC).....	289
7.4.1	Procedure.....	289
7.5	STORING SEQUENCE PROGRAMS IN THE PMC (DURING CONNECTION WITH THE PMC).....	295
7.5.1	Procedure.....	295
7.6	WRITING SEQUENCE PROGRAMS INTO F-ROM	297
7.6.1	Procedure.....	297
7.7	COMPARING WITH PMC	298
7.7.1	Menu Bar.....	298
7.7.2	Program Transfer Wizard	299
7.7.2.1	Selecting a transfer method.....	299
7.7.2.2	Selecting a transfer direction	300
8	EXECUTING AND STOPPING SEQUENCE PROGRAMS	301
8.1	EXECUTING SEQUENCE PROGRAMS	302
8.2	STOPPING SEQUENCE PROGRAMS	303
9	DIAGNOSIS.....	304
9.1	LADDER MONITORING	305

9.1.1	Procedure.....	305
9.1.2	[Monitor] Screen	306
9.1.3	[Edit] Screen.....	307
9.1.3.1	Multiple used check of the functional instruction parameter number.....	308
9.1.4	Signal Trigger Stop Function	309
9.1.4.1	Procedure	309
9.1.4.2	Executing the signal trigger stop function	310
9.1.4.3	Terminating the signal trigger stop function.....	311
9.1.4.4	[Trigger Parameter] screen	312
9.1.4.5	Context menu.....	313
9.1.4.6	Shortcut key list.....	313
9.1.5	Mnemonic Monitor.....	313
9.2	SIGNAL STATUS	317
9.2.1	Procedure.....	317
9.2.2	Toolbar	318
9.2.3	Status Bar	318
9.2.4	Context Menu	319
9.2.5	Shortcut Keys	319
9.3	PMC PARAMETERS	320
9.3.1	Procedure.....	320
9.3.2	Timer	320
9.3.2.1	Toolbar.....	321
9.3.2.2	Status bar	321
9.3.2.3	Context menu.....	321
9.3.2.4	Shortcut keys	321
9.3.3	Counter.....	322
9.3.3.1	Toolbar.....	322
9.3.3.2	Context menu.....	322
9.3.3.3	Shortcut keys	322
9.3.4	Keep Relay	323
9.3.4.1	Toolbar.....	323
9.3.4.2	Context menu.....	323
9.3.4.3	Shortcut keys	323
9.3.4.4	Data for PMC control software.....	324
9.3.5	Data Table	325
9.3.5.1	Toolbar.....	326
9.3.5.2	Status bar	327
9.3.5.3	Shortcut keys	327
9.3.5.4	Input data range	327
9.3.5.5	Context menu.....	327
9.3.6	Setting PMC Setting Parameters	328

9.3.6.1	Programmer protect function	328
9.3.6.2	Procedure	329
9.3.6.3	Setting items	330
9.3.6.4	Warning message.....	332
9.3.6.5	Setting screen of the selectable I/O link assignment function	333
9.4	PMC ALARM STATUS	334
9.4.1	Procedure.....	334
9.4.2	Switching the Language in which PMC Alarm Messages are Displayed	335
9.5	PMC STATUS.....	336
9.5.1	Procedure.....	336
9.5.2	Display Items.....	337
9.6	SIGNAL TRACING	338
9.6.1	Procedure.....	338
9.6.2	Toolbar	339
9.6.3	Status Bar	340
9.6.4	Context Menu	340
9.6.5	Shortcut Keys	340
9.6.6	[Signal Trace Parameter] Screen	340
9.6.7	Automatic Trace Function at Power-On.....	341
9.7	SIGNAL ANALYSIS	342
9.7.1	Procedure.....	342
9.7.2	Toolbar	343
9.7.3	Status Bar	344
9.7.4	Context Menu	344
9.7.5	Shortcut Keys	345
9.7.6	[Signal Analysis Parameter] Screen	346
9.7.7	[Signal Analysis Format] Screen	348
9.7.8	[Gridline Format] Screen.....	349
9.7.9	Automatic Signal Sampling Function at Power-On	349
9.8	CLEARING PMC AREAS	350
9.8.1	Procedure.....	350
9.9	ACTIVATING THE I/O Link.....	351
9.9.1	Procedure.....	351
9.10	SIGNAL TRACE FUNCTION	352
9.10.1	Procedure.....	352
9.10.2	Toolbar	353
9.10.3	Status Bar	354
9.10.4	Setting Trace Parameters.....	355

9.10.5	Setting Details of Trace Mode.....	357
9.10.6	Setting Trace Parameters (Sampling Addresses).....	358
9.10.7	Context Menu.....	360
9.10.8	Shortcut Keys.....	360
9.10.9	Automatic Sampling Function at Power-on.....	360
10	COMMAND LINE EXECUTION FUNCTION.....	361
10.1	OUTLINE.....	362
10.2	PROCEDURE.....	363
10.3	COMMANDS.....	363
10.4	COMMAND SPECIFICATIONS.....	364
10.4.1	Opening an *.LAD File.....	364
10.4.2	Closing an *.LAD File.....	364
10.4.3	Compiling an *.LAD File.....	365
10.4.4	Decompiling an *.LAD File.....	367
10.4.5	Converting the Source Program of an *.LAD File to a Mnemonic File.....	369
10.4.6	Converting a Mnemonic File to the Source Program.....	370
10.4.7	Importing Data from the Specified File.....	372
10.4.8	Exporting Data to the Specified File.....	374
10.4.9	Creating a New *.LAD File.....	376
10.4.10	"*.LAD" File is Changed to Other PMC Type of "*.LAD" File.....	377
10.4.11	Terminating Command Processing.....	379
10.5	SAMPLE COMMAND FILE.....	380
10.6	NOTE.....	380
10.7	EXECUTION LOG FILE.....	381
11	EXTENDED SYMBOL/COMMENT FUNCTION.....	383
11.1	ABOUT SYMBOL/COMMENT DATA.....	385
11.1.1	Relation between the global symbol and the local symbol.....	386
11.1.2	About the Symbol Type.....	388
11.1.3	About the Distinction of Symbol and Address.....	388
11.2	EDITING SYMBOL AND COMMENT.....	389
11.2.1	Toolbar.....	389
11.2.2	Context Menu.....	390
11.2.3	Add New Symbol and Comment.....	391
11.2.4	Modifying Symbol and Comment Data.....	392
11.2.5	Cut, Copy and Paste of Symbol or Comment Data.....	393
11.2.6	Deleting Symbol and Comment Data.....	393

11.2.7	Search	393
11.3	EDITING LADDER DIAGRAMS.....	395
11.3.1	How to View whole Program.....	395
11.3.2	How to Display and Modify Ladder Program.....	395
11.3.3	How to Create Ladder Program.....	397
11.3.4	Tool Tip.....	398
11.3.5	Comment of Contact and Coil.....	398
11.3.6	How to Change Symbol or Address	399
11.3.6.1	Search function	399
11.3.6.2	Collective Display function	401
11.3.6.3	Replace function	404
11.3.7	How to Add Sub-program	406
11.3.8	Notes at Editing Ladder Program	407
11.3.9	Input of Jump Label by Symbolic Name.....	408
11.4	AUTOMATIC ADDRESS ASSIGNMENT FUNCTION	413
11.4.1	Set Screen	413
11.4.2	Set of Symbol	414
11.4.3	Address Decision.....	415
11.5	CONVERTING TO SOURCE PROGRAMS.....	416
11.6	CONVERTING TO MNEMONIC	417
11.7	SYSTEM PARAMETER.....	418
11.7.1	Set of Display Language for Comment	418
11.8	COMPILATION	419
11.9	DECOMPILATION	420
11.10	PRINTING	421
11.10.1	Printing the System Parameters.....	421
11.10.2	Printing the Symbol Comment	421
11.10.3	Printing the Ladder Diagram.....	422
11.10.4	Printing Cross Reference.....	423
11.10.5	Printing the Bit Address	423
11.11	SIGNAL STATUS	424
11.11.1	Toolbar	424
11.12	T ADDRESS (TIMER).....	425
11.12.1	Toolbar	425
11.13	C ADDRESS (COUNTER).....	425
11.13.1	Toolbar	425
11.14	K ADDRESS (KEEP RELAY)	426

11.14.1	Toolbar	426
11.15	D ADDRESS (DATA TABLE).....	426
11.15.1	Toolbar	426
11.16	SIGNAL TRACING	427
11.16.1	Toolbar	427
11.17	TOOLTIPS INDICATION	428
11.18	MNEMONIC FILE FORMAT	429
11.18.1	System Parameter	429
11.18.2	Symbol Comment.....	431
11.18.3	Ladder.....	432
11.19	HOW TO CONVERT FROM CONVENTIONAL MODEL	433
11.19.1	Converting Mnemonic File	433
11.19.2	Create Ladder Program of Extended Function and Change to Source File.....	434
12	CONVERTING SEQUENCE PROGRAMS.....	435
12.1	CONVERTING FROM DOS-VERSION FANUC LADDER-II	436
12.1.1	Procedure.....	436
12.2	CONVERTING TO DOS-VERSION FANUC LADDER-II	438
12.2.1	Procedure.....	438
12.3	CONVERTING SEQUENCE PROGRAMS BETWEEN PMC MODELS	439
12.3.1	Conversion by Changing System Parameters.....	439
12.3.2	Using System Program Data for Another Program	441
13	ERROR MESSAGES	442
13.1	ERROR MESSAGE FORMAT	443
13.1.1	Function Symbols.....	443
13.1.2	Message Classification	444
13.2	ERROR MESSAGES.....	445
13.2.1	File	445
13.2.2	Title Editing.....	446
13.2.3	I/O Module Editing	446
13.2.4	System Parameter Editing	447
13.2.5	Ladder/Step Sequence Editing	447
13.2.6	Message Editing	451
13.2.7	Print	451
13.2.8	Compile	451
13.2.9	Decompile	457
13.2.10	Mnemonic Conversion	459

13.2.11	Input/Output	465
13.2.12	Online	466

APPENDIX

A	CABLE FOR DATA TRANSFER	469
B	CONVERSION USING A SIGNAL ADDRESS CONVERTER	470
C	LANGUAGE PROGRAM LINK FUNCTION.....	472
D	MULTI-LANGUAGE PMC MESSAGE CREATION TOOL.....	474
D.1	FILE FORMAT OF A MESSAGE SOURCE FILE	478
D.1.1	Sample File.....	480
D.1.2	Usable Characters.....	481
D.1.3	Entering Special Characters	485
D.1.3.1	New line character.....	485
D.1.3.2	Numeric data.....	485
D.1.3.3	Reservation character.....	486
D.2	USAGE	487
D.3	ERROR MESSAGES.....	491
D.3.1	Error List.....	491
E	DATA FORMAT OF THE EXTERNAL SYMBOL FILE	493
E.1	OPTION OF IDENTIFICATION CODE	494
E.2	ABOUT THE CHARACTER OF THE EXTERNAL SYMBOL FILE.....	496
E.3	COMPATIBILITY OF THE EXTERNAL SYMBOL FILE	497

1

SETUP

This chapter describes the operating environment of FANUC LADDER-III. This chapter also describes how to set up FANUC LADDER-III to make software ready for use.

1.1 OPERATING ENVIRONMENT

The operating environment required for this software is as follows:

- Computer
PC/AT-compatible computer running Windows 98 SE, NT4.0, 2000, Me, or XP (English/Japanese system)
- CPU
Pentium 133 MHz or better
- Memory
For Windows 98 SE
 - 16MB or more (32MB or more recommended)
For Windows NT 4.0
 - 24M or more (32MB or more recommended)
For Windows 2000, Me, or XP
 - 32MB or more (64MB or more recommended)
- Hard disk
20MB of free space required (at installation)
100MB of free space required (at execution)

NOTE

- 1 Time required for ladder diagram editing and processing of symbols and net comments is affected by the free spaces of memory and the hard disk. When handling a source program including many ladders, symbols, comments, or net comments or editing ladder diagrams on multiple screens, allocate much more free spaces as far as possible.
- 2 We recommend that FANUC LADDER-III be run under Windows 98 SE, Windows NT 4.0, Windows 2000, Windows Me, or Windows XP.

1.2 INSTALLATION AND UNINSTALLATION

This section describes how to install or uninstall this software.

NOTE

- 1 Both of FAPT LADDER-III and FANUC LADDER-III cannot be installed on the same personal computer.
- 2 Normally, when FANUC LADDER-III is installed, FAPT LADDER-III is automatically uninstalled.
- 3 If FAPT LADDER-III is not automatically uninstalled, uninstall the software manually, then install FANUC LADDER-III.

1.2.1 Installation

Procedure

- 1 Preparation prior to installation
 - 1-1 Before installation, see Section 1.1, "OPERATING ENVIRONMENT" to check the environment of the computer being used.
- 2 Starting the installer
 - 2-1 If any programs are running, terminate them.
 - 2-2 Set the disk (A08B-9210-J505) in the CD-ROM drive. Windows automatically starts installation.
 - 2-3 If Windows does not automatically start installation, click [Start Menu] - [Run]. Type the following in the Open field, and then click <OK>

(CD-ROM drive name):\FL3AutoRun.exe

- 3 Starting setup and confirming the license agreement
 - 3-1 FANUC LADDER-III setup starts, displaying the [Choose Setup Language] screen. Select Japanese or English, and then click the <OK> button.

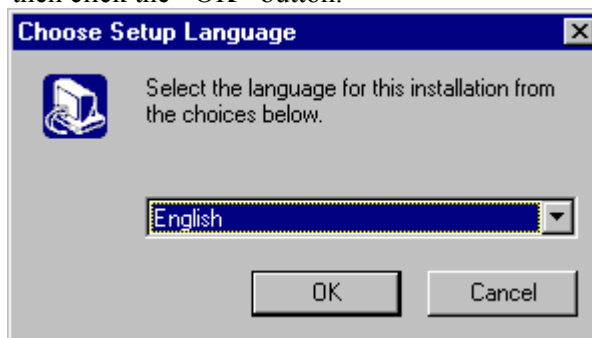

Fig. 1.2.1 (a)

- 3-2 The [Welcome to the InstallShield Wizard for FANUC LADDER-III] screen appears.

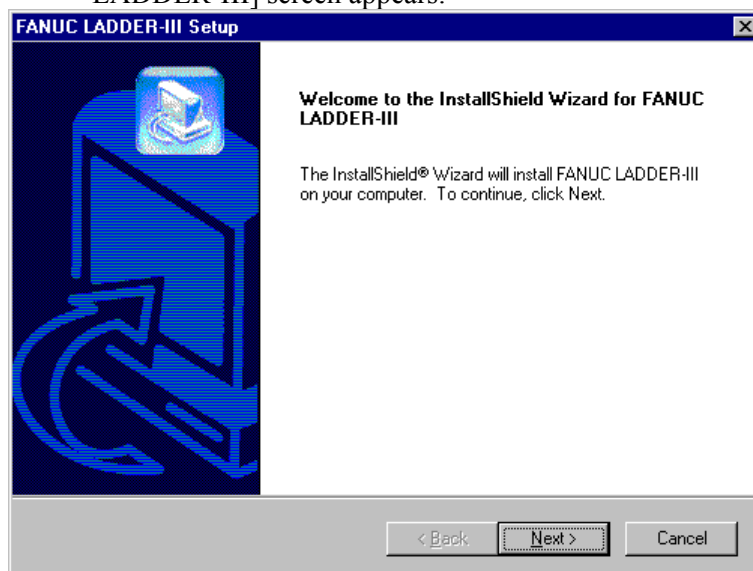

Fig. 1.2.1 (b)

NOTE

When the upgrade version (A08B-9210-J506) is installed, an older version is first uninstalled and then the new version is installed.

- 3-3 Click the <Next> button. Then, the [License Agreement] screen appears.

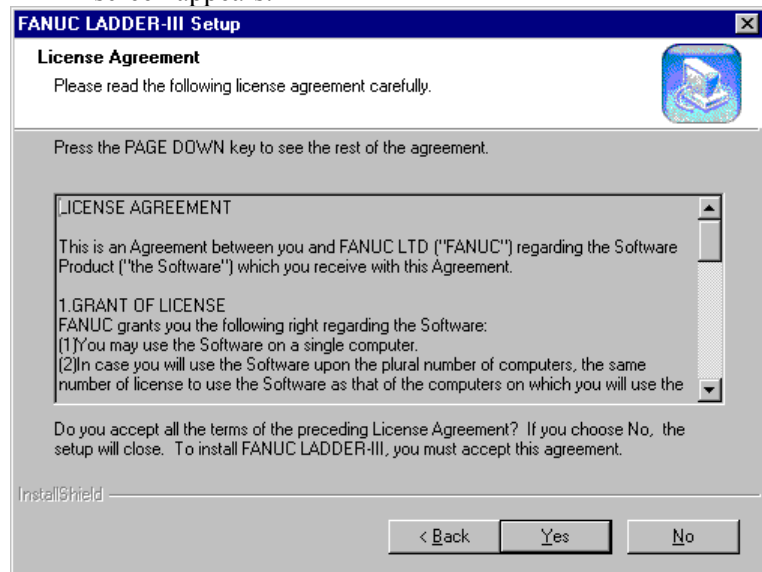
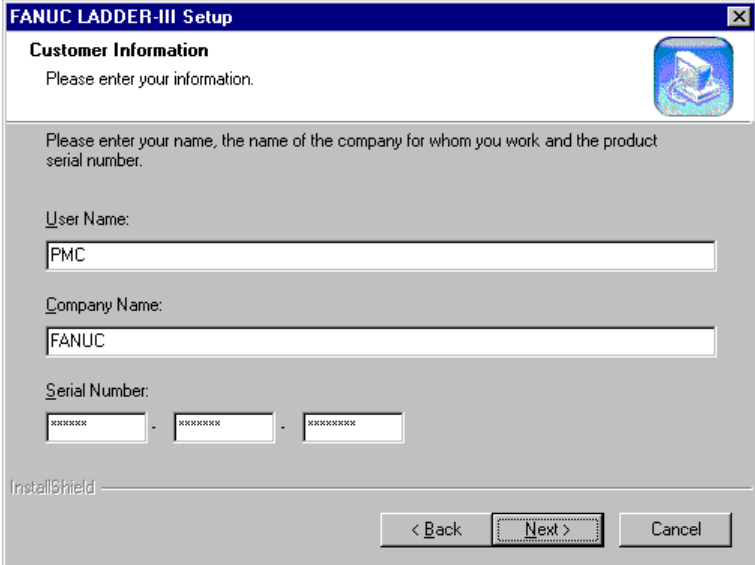

Fig. 1.2.1 (c)

- 3-4 When you agree to the terms of the license agreement, and wish to continue installation, click the <Yes> button. Clicking the <No> button stops installation.

4 Entering user information

4-1 The [Customer Information] screen appears.



The screenshot shows a window titled "FANUC LADDER-III Setup" with a sub-header "Customer Information". Below the sub-header, it says "Please enter your information." and "Please enter your name, the name of the company for whom you work, and the product serial number." There are three input fields: "User Name:" with the text "PMC", "Company Name:" with the text "FANUC", and "Serial Number:" with three masked boxes (each containing "xxxxxxx"). At the bottom right, there are three buttons: "< Back", "Next >" (highlighted with a dashed border), and "Cancel".

Fig. 1.2.1 (d)

4-2 Enter [User Name], [Company Name], and [Serial Number] and then click the <Next> button. Then, the [Registration Confirmation] screen appears.

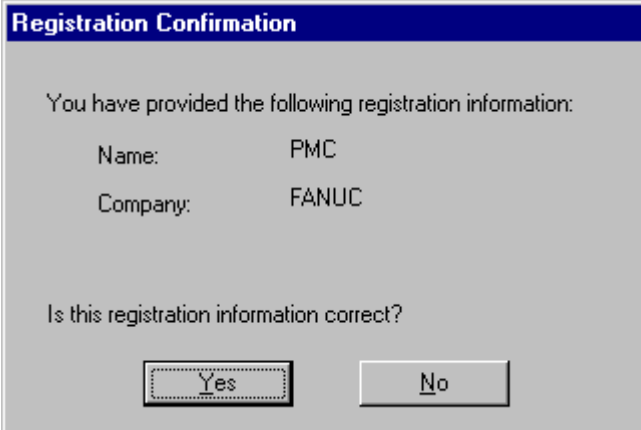

The screenshot shows a window titled "Registration Confirmation". It displays the text "You have provided the following registration information:" followed by "Name: PMC" and "Company: FANUC". Below this, it asks "Is this registration information correct?". At the bottom, there are two buttons: "Yes" (highlighted with a dashed border) and "No".

Fig. 1.2.1 (e)

4-3 Check that the registration information is correct. To continue the installation, click the <Yes> button. Clicking the <No> button returns you to the [Customer Information] screen.

5 Selecting the installation destination and program folder

5-1 The [Choose Destination Location] screen appears.

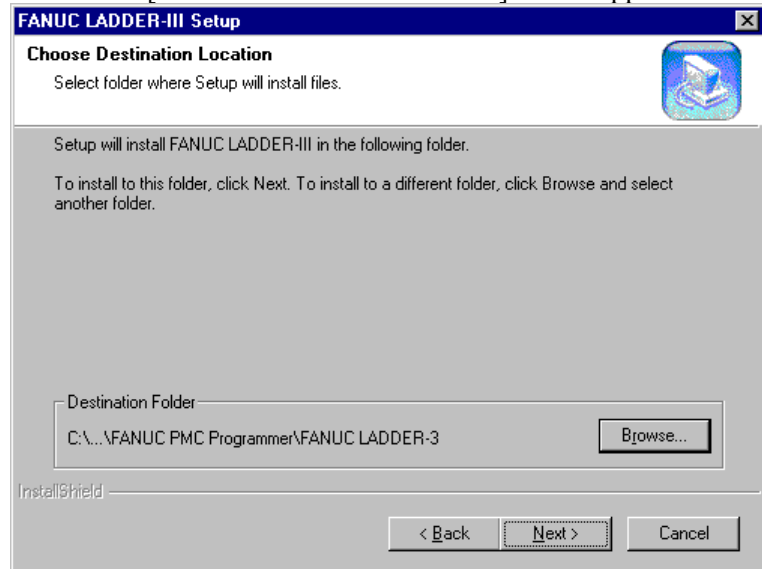

Fig. 1.2.1 (f)

5-2 By default, the program is installed in C:\Program Files\FANUC PMC Programmer\FANUC LADDER-3. To change the installation destination, click the [Browse...] button, and then select the installation destination.

5-3 Click the <Next> button.

5-4 The [Select Program Folder] screen appears.

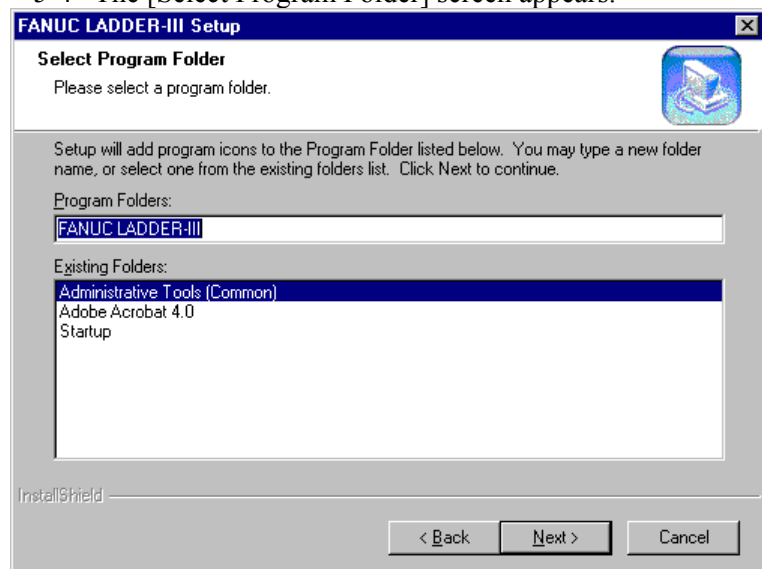

Fig. 1.2.1 (g)

5-5 Select the program folder in which you want to install the program or create a folder. Then, click the <Next> button.

6 Starting file copy operation and ending the installation

6-1 The [Start Copying Files] screen appears.

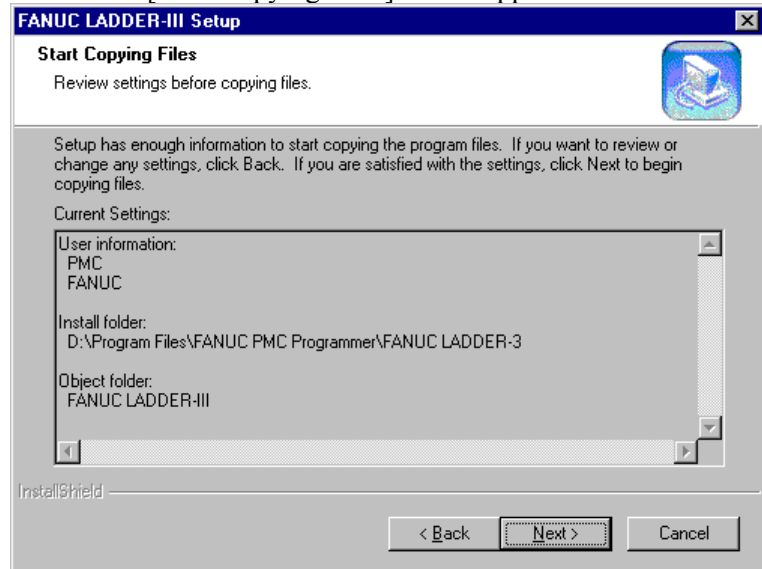

Fig. 1.2.1 (h)

6-2 Information for starting the program file copy operation is displayed. To change the information, click the <Back> button. Check that the displayed information is correct, and then click <Next>. Then, file copy operation starts.

6-3 As the file copy operation terminates, the [InstallShield Wizard Complete] screen appears.

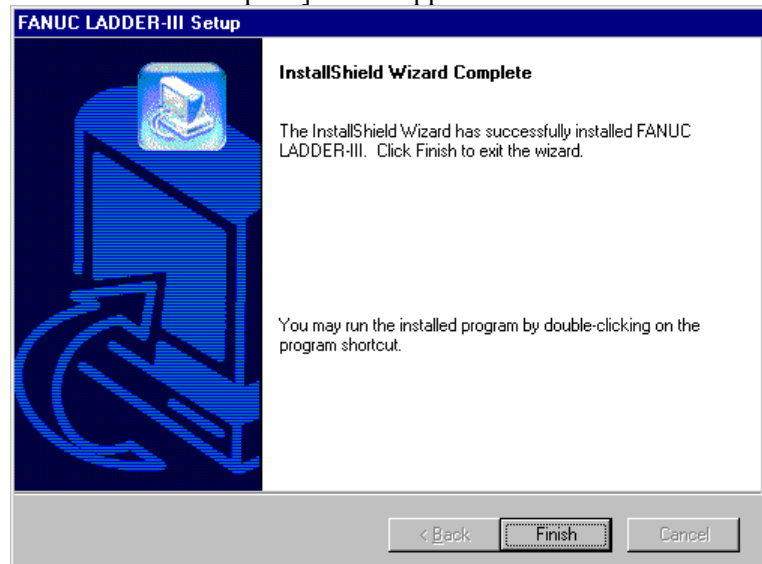

Fig. 1.2.1 (i)

6-4 Clicking [Finish] terminates installation.

1.2.2 Uninstallation

Procedure

- 1 Terminating FANUC LADDER-III
 - 1-1 FANUC LADDER-III cannot be uninstalled while it is running. Terminate FANUC LADDER-III, and then uninstall it.
- 2 Starting the uninstaller
 - 2-1 Click [Start Menu] - [Settings] - [Control Panel].
 - 2-2 On the [Control Panel] screen, click [Add/Remove Programs].
 - 2-3 The [Add/Remove Programs Properties] screen appears.

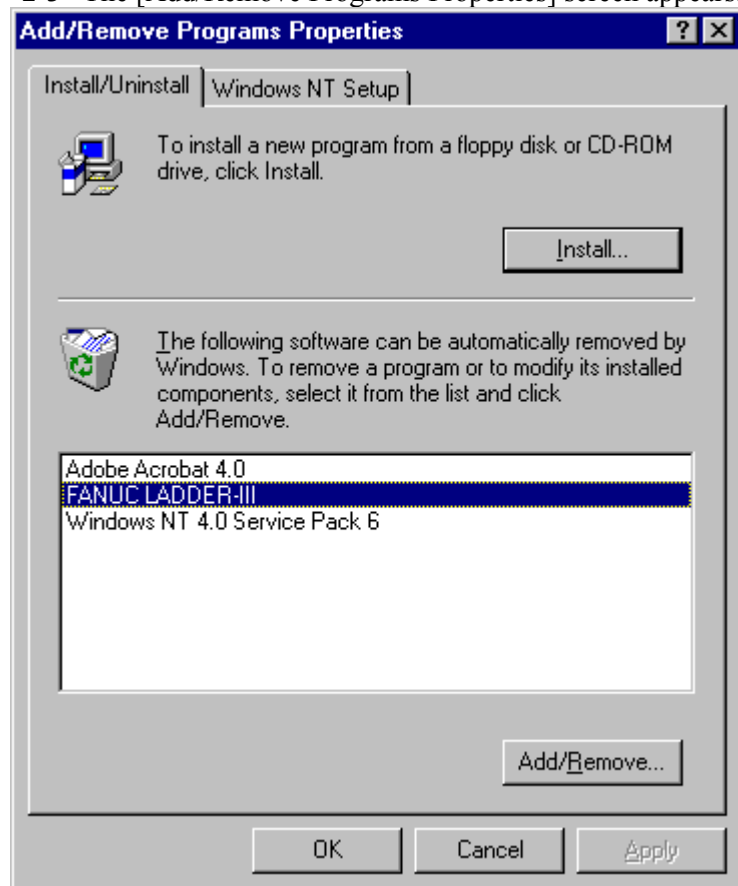

Fig. 1.2.2 (a)

- 2-4 Select FANUC LADDER-III, and then click <Add/Remove>.

3 Confirming uninstallation

3-1 A dialog box appears, asking whether you really want to uninstall the program. Select <OK>.

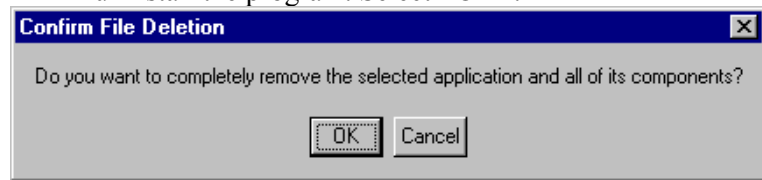

Fig. 1.2.2 (b)

4 Executing uninstallation

The installed files, folders, and start menu items are deleted, and the original system settings are restored.

Uninstallation then ends.

The uninstaller sometimes cannot uninstall all the files and folders of FANUC LADDER-III, such that some files or folders may remain after uninstallation. Should this occur, restart the system, and then delete the remaining files/folders by using My Computer or Explorer.

2

BASICS

This chapter describes the basic items the user should understand before using FANUC LADDER-III.

2.1 START AND END

This section describes how to start and end FANUC LADDER-III.

2.1.1 Starting FANUC LADDER-III

To start this software, use the following procedure:

Procedure

- 1 Click the [Start] button.
- 2 From the [Start] menu, select [Program].
- 3 From the [Program] menu, select the [FANUC LADDER-III] folder.
- 4 From the [FANUC LADDER-III] folder, select FANUC LADDER-III.

2.1.2 Starting FANUC LADDER-III (Online Connection)

By specifying the following argument in the executable file of FANUC LADDER-III, you can automatically connect FANUC LADDER-III to a specified port.

- For an RS-232-C port
Fladder.exe/COM=<COM-port-number>
Example) Fladder.exe/COM=1
- For an Ethernet port
Fladder.exe/H=<host-name>:<port-name>
Example) Fladder.exe/H=190.0.55.55:8193

2.1.3 Terminating FANUC LADDER-III

To terminate this software, use the following procedure:

On the [File] menu, click [Exit]. Alternatively, click  (<Close> button) in the upper right corner of the parent window.

2.2 WINDOW NAMES AND FUNCTIONS

This section describes the names and functions of the windows displayed by this software.

As shown in the figure below, child windows are displayed within the parent window. These are required for operations such as the creation of sequence programs for the FANUC PMC.

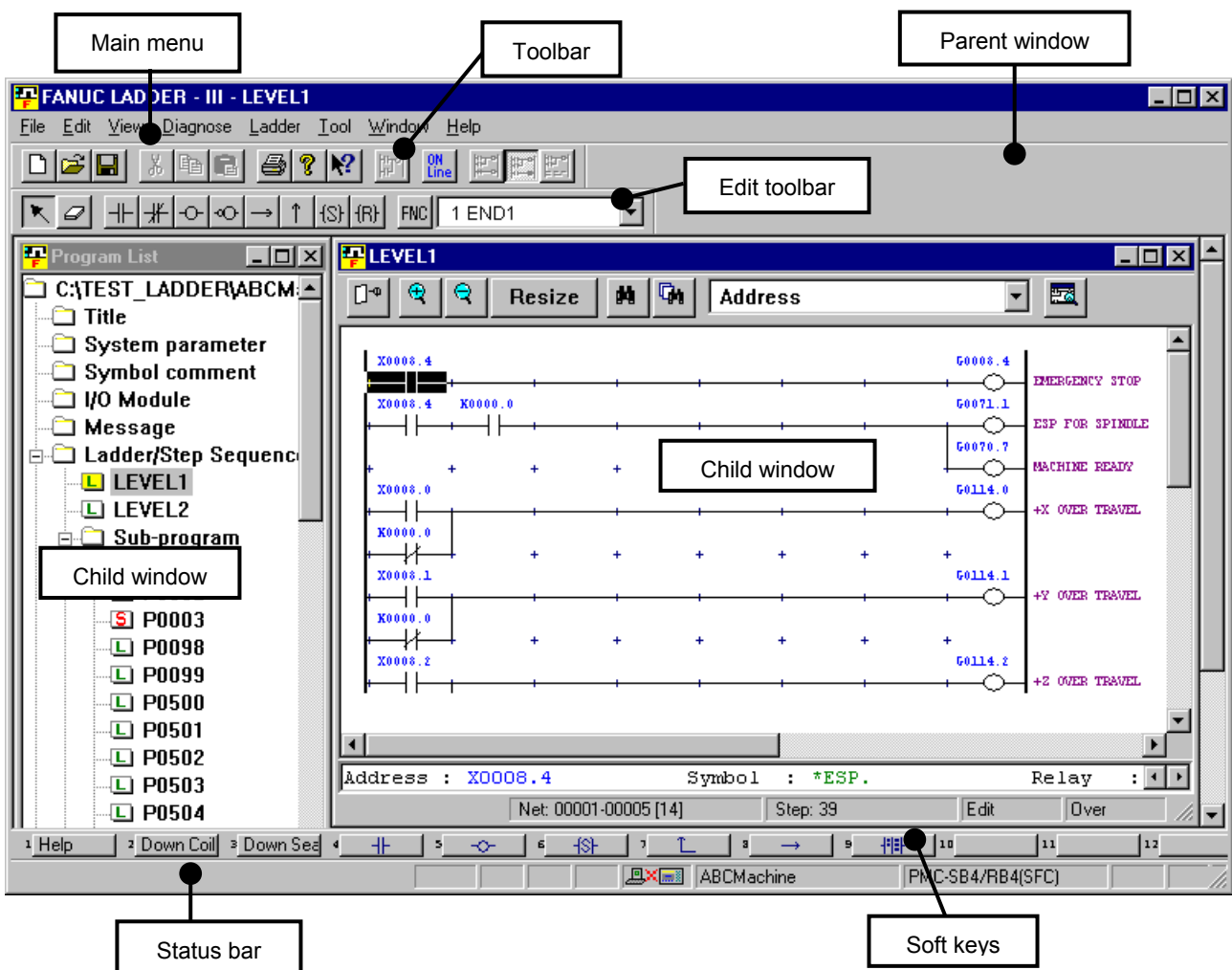

Fig. 2.2

- Parent window
The main window of this software.
Multiple child windows can be displayed within the parent window.
- Child window
Child windows are displayed within the parent window.
Child windows are used for displaying and editing FANUC PMC sequence programs.

2.2.1 Main Menu

Each main menu has submenus, as listed below.

Table 2.2.1

Main menu	Submenu	Reference chapter, section, or subsection
File	New Program Open Program Close Program Save Save As Import Export Print Preview Exit	3.2 CREATING NEW PROGRAMS 3.3 OPENING EXISTING PROGRAMS 3.13 CLOSING PROGRAMS 3.11 SAVING PROGRAMS 3.12 SAVING PROGRAMS WITH NAMES 3.14 IMPORTING PROGRAMS 3.15 EXPORTING PROGRAMS 4 PRINTING SEQUENCE PROGRAMS 4 PRINTING SEQUENCE PROGRAMS 2.1.3 Terminating FANUC LADDER-III
Edit	Undo Cut Copy Paste Select All Add Data Delete Delete All Find Replace Jump	3.5 EDITING LADDER DIAGRAMS 3.7 EDITING SYMBOLS AND COMMENTS 3.8 EDITING MESSAGES 3.9 EDITING I/O MODULE ASSIGNMENT
View	ToolBar Status Bar Softkey Edit ToolBar Program List Grid Line	3.5 EDITING LADDER DIAGRAMS
Diagnose	Signal Status PMC Parameter Timer Counter Keep Relay Data Table Set Up PMC Alarm Status PMC Status Signal Trace Signal Analysis	9.2 SIGNAL STATUS 9.3 PMC PARAMETERS 9.3.2 Timers 9.3.3 Counters 9.3.4 Keep Relays 9.3.5 Data Table 9.3.6 Setting PMC Parameters 9.4 PMC ALARM STATUS 9.5 PMC STATUS 9.6 SIGNAL TRACING 9.7 SIGNAL ANALYSIS
Ladder	Online/Offline Monitor/Editor	3.5 EDITING LADDER DIAGRAMS 3.5 EDITING LADDER DIAGRAMS

Table 2.2.1

Main menu	Submenu	Reference chapter, section, or subsection
Tool	Mnemonic Convert	6.1 CONVERTING SOURCE PROGRAMS TO MNEMONIC FILES
	Source Program Convert	6.2 CONVERTING MNEMONIC FILES TO SOURCE PROGRAMS
	Data Conversion	12 CONVERTING SEQUENCE PROGRAMS
	Data File→LAD File	12.1 CONVERSION FROM DOS FANUC LADDER-II
	Data File←LAD File	12.2 CONVERSION TO DOS FANUC LADDER-II
	Compile	5.1 COMPILATION
	Decompile	5.2 DECOMPILATION
	Communication	7.1 SETTING COMMUNICATION
	Device Select	
	Load from PMC	7.2, 7.3 LOADING SEQUENCE PROGRAMS FROM PMC
	Store to PMC	7.4, 7.5 STORING SEQUENCE PROGRAMS IN PMC
	Clear PMC Memory	9.8 CLEARING PMC AREAS
	I/O Link Restart	9.9 ACTIVATING THE I/O LINK
	Backup	7.6 WRITING SEQUENCE PROGRAMS INTO F-ROM
Program Run/Stop Option	8 RUNNING AND STOPPING SEQUENCE PROGRAMS	
Window	Cascade	
	Tile	
	Arrange Icons	
Help	Topic	
	Help	
	About version information	

2.2.2 Toolbar

The toolbar contains a set of buttons used for file operations and editing.

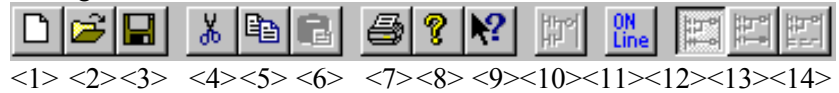

Fig. 2.2.2

- <1> New Program
Creates a new program.
- <2> Open Program
Opens an existing program
- <3> Save
Saves a program.
- <4> Cut
Removes a selected portion.
- <5> Copy
Copies a selected portion.
- <6> Paste
Pastes a cut or copied portion.
- <7> Print
Prints a program.
- <8> About version information
Displays version information.
- <9> Context-sensitive help
Displays the help text for the portion specified with the mouse.
- <10> Run/stop program
Runs or stop a Ladder program.
- <11> Online/Offline
Switches the system between online and offline modes.
- <12>, <13> Ladder monitor, Online editing
Switches the system between ladder monitor and online editing.
- <14> Signal trigger stop
Runs the signal trigger stop function.

2.2.3 Edit Toolbar

The edit tool bar contains a set of buttons used for editing ladder diagrams. You can input contacts and coils by using the edit tool bar. See Section 3.5, "EDITING LADDER DIAGRAMS" for details.

2.2.4 Soft Keys

To perform operations with the currently selected child window, you can select the displayed soft keys either by using the mouse or by pressing keys. You can change the display size of soft keys using [Softkey] in the [View] menu.



Fig. 2.2.4

2.2.5 Status Bar

The status bar provides information such as a sequence program name and PMC model name.

2.2.6 Status Monitor

The target of connection (Loader or path number) and the state of the communication with PMC are displayed on the top-right side of the main window.

Non-display/display of Status monitor can be switched by [status monitor] in [View] menu.

- When communicating to the first PMC



2.3 DISPLAYING VERSION INFORMATION

This section describes how to display the version information of this software for purposes of, for example, maintenance.

Procedure

Select [Help] - [About version information...].

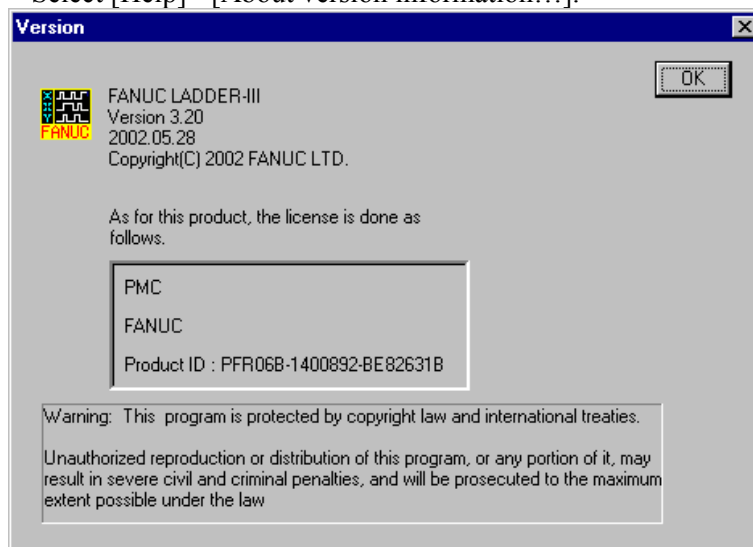

Fig. 2.3

3

CREATING AND EDITING SEQUENCE PROGRAMS

This chapter describes how to create and edit sequence programs. A sequence program consists of a title, system parameters, symbols, comments, I/O modules, messages, and ladder/step sequences.

3.1 SEQUENCE PROGRAMS

This section describes sequence programs.

3.1.1 Procedure for Creating Sequence Programs

The following flowchart illustrates the procedure for creating a sequence program.

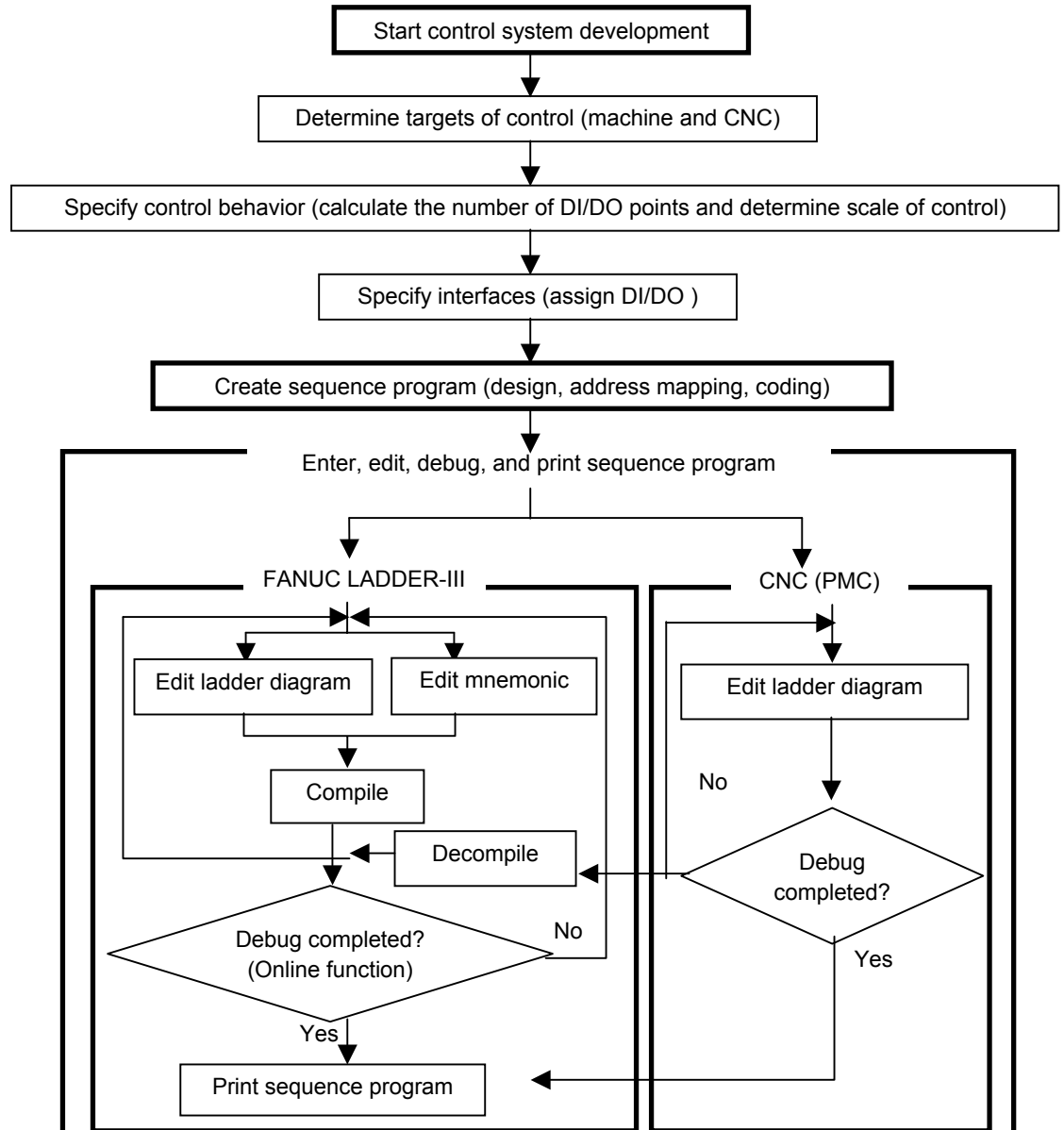

In online editing, programming and monitoring are carried out on a personal computer connected to the CNC (PMC).

In offline editing, programming is carried out on a personal computer not connected to the CNC (PMC).

The other PMC programming systems (for use on personal computers) include FANUC LADDER (DOS) and FANUC LADDER-II (DOS).

Refer to the following manuals:

- FANUC LADDER (for PC) Operator's Manual (B-66131E)
- FANUC LADDER-II Operator's Manual (B-66184EN)

- Sequence programs

A sequence program consists of the data listed below.

- Title data
- System parameters
- Symbols/comments
- Message data
- I/O module data
- I/O module comments
- Ladder level 1
- Ladder level 2
- Ladder level 3
- Ladder subprograms
- Step sequence subprograms
- Net comments
- Memory card format data

In FANUC LADDER-III, a file with extension .LAD (hereafter called a LAD file) holds all sequence program data.

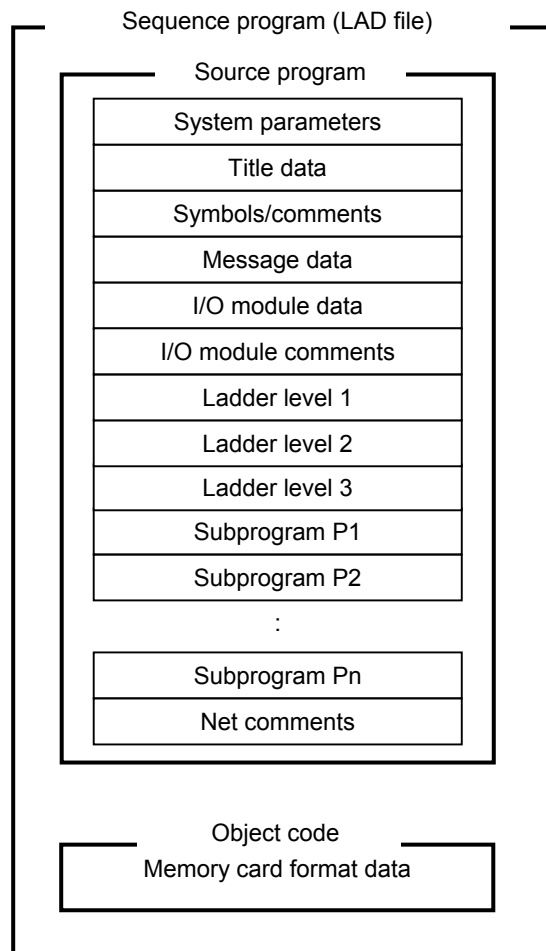
**NOTE**

- 1 In FANUC LADDER-III, a sequence program to be printed or edited offline is called a source program.
- 2 An I/O module comment is one given to a module address in the I/O unit. See Section 3.9, "Editing I/O Module Assignment," for details.

- Data flow

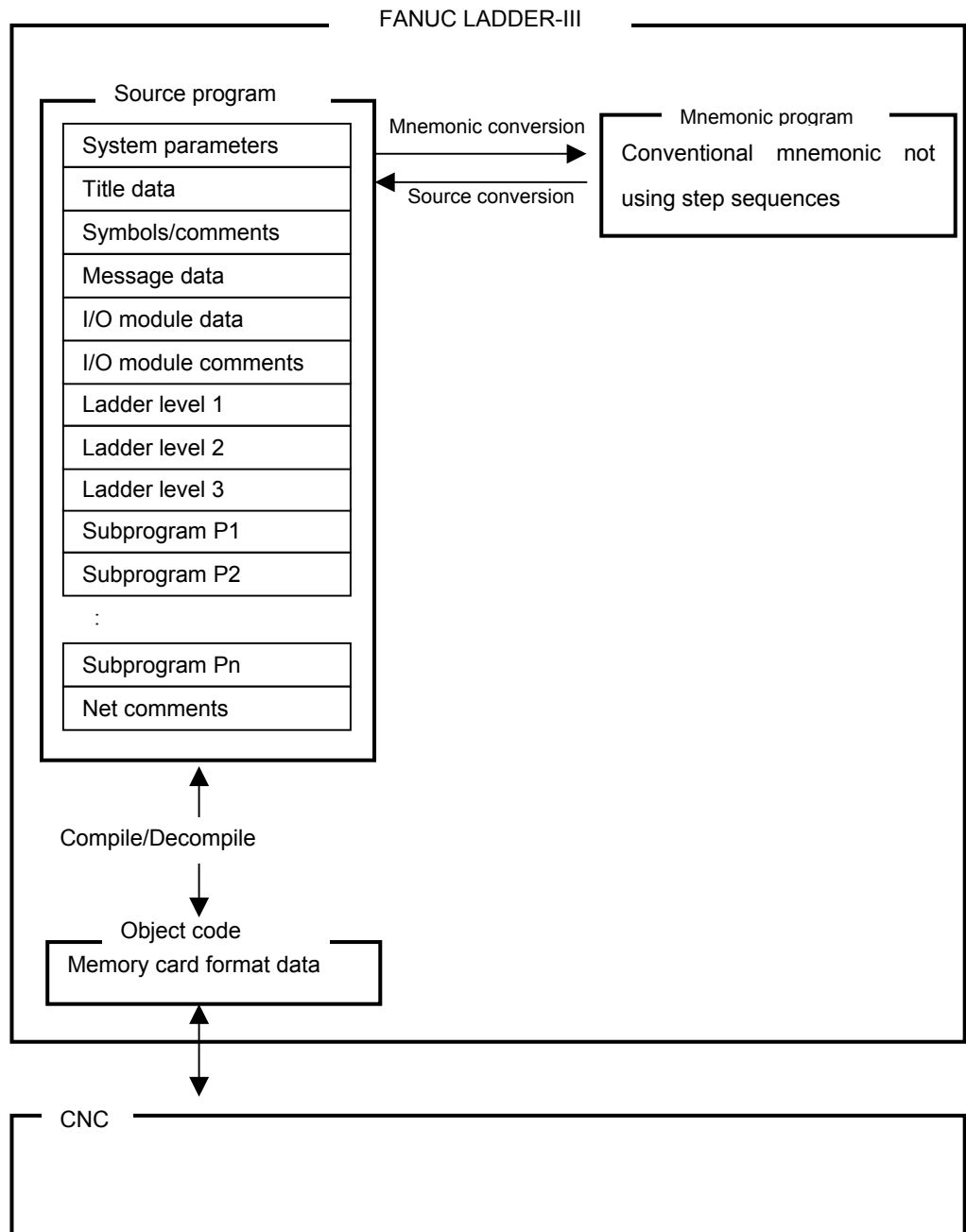

3.1.2 PMC Programming Method

The ladder method is one of the most extensively used methods for programming PMC-based sequence control. Because this method was originally based on control circuits in relay panels, it was initially easy for sequence control engineers to understand. As the number of PMC functions has increased, however, sequence programs have become large and complicated. To cope with this situation, we have introduced step sequence programming.

- What is the step sequence method?
The step sequence method is a sequence control programming method that is based on a programmable controller. This method is intended to represent a flow of control directly using a flowchart. With this method, an individual control module is described using the conventional ladder method. Therefore, the step sequence method allows the user to visually describe the entire process flow. So, it is suitable for total process control. See "Introduction--Features of FANUC LADDER-III and its Functions Classified by PMC Model," for details on the models that can use step sequences.
- Sequence configuration
Ladder programs can take any one of the following five configurations.
 - Ladder level 1
 - Ladder level 2
 - Ladder level 3
 - Ladder subprogram
 - Step sequence subprogram

NOTE

Ladder level 3 is omissible.

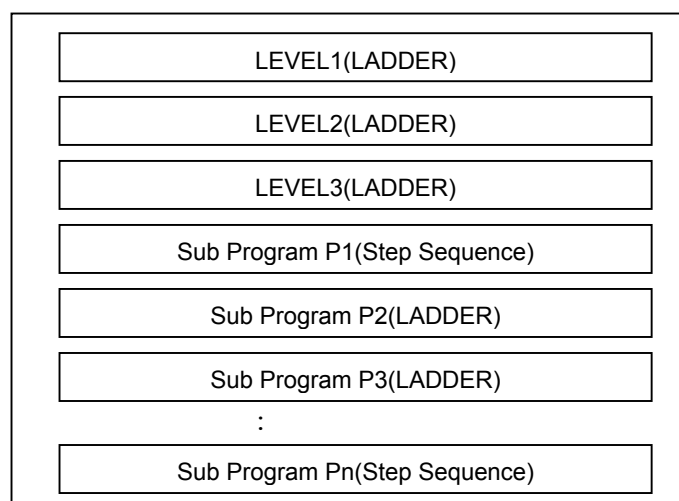

3.1.3 Work Folders and Online Program Files

- **Work folder**
A program work folder is created automatically on a path set up in the TMP environment variable. The work folder is called WFLAD* where * represents any number.

- **User file folder**
A user file folder, called MyFladder, is created automatically in the work folder mentioned above. A user file can be saved if required, along with other data files, to a LAD file, when LAD programs are saved.
When PMC parameters are transferred with the input/output function, PMC_PRM.PRM in the user file folder is initially set for a parameter file transfer destination and transfer source file name.

- **Online program file**
If communication is started with no program open, a program is loaded from the PMC, and the following LAD files are created automatically in the LAD folder.
 - If connected with the main PMC:
PMC0000.LAD to PMC0009.LAD
 - If connected with the loader PMC:
PMC1000.LAD to PMC1009.LAD
 - If connected with 1st PMC:
PMC0000.LAD to PMC0009.LAD
 - If connected with 2nd PMC:
PMC0100.LAD to PMC0109.LAD
 - If connected with 3rd PMC:
PMC0200.LAD to PMC0209.LAD
 - If connected with PMC for Dual check safety:
PMC0800.LAD to PMC0809.LAD

These files are referred to as online program files.

When there is an online program file, and if communication is started with no program opened, an online program file that matches that on the PMC is opened automatically. Therefore, the program can be debugged online without loading it from the PMC so often.

NOTE

Up to ten online program files can be held. When you finish debugging program, save the program file under a different file name.

3.1.4 Device Selection

Selection of CNC Main and LOADER

When the Loader control board is attached and both the Main side and the Loader side PMC can communicate, the following dialog is displayed.

Please specify the connected controller. When current controller is changed, the communication with PMC is executed again.

Procedure

1. If the loader has been installed, the following dialog box automatically appears at the start of communication.

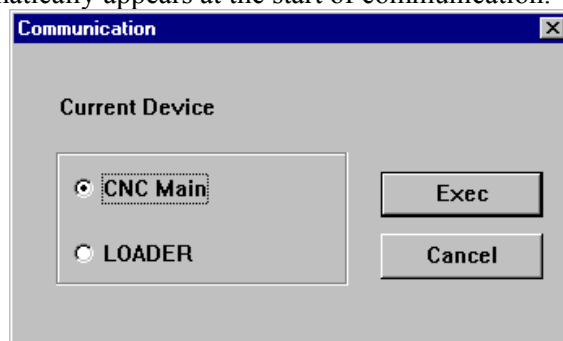

Fig. 3.1.4(a)

2. Select the device you want to connect using the [↑] and [↓] keys.
3. Click the <Exec> button.

NOTE

Selected connection is effective until the communication is disconnected. To change connection, please disconnect the communication and reestablish the communication from the communication in tool menu again.

Selection of Multi-path PMC

[Selection of device] dialog box appears by the following operation.

- Starting the communication to PMC when no program is opened.
- Starting the communication to PMC when PMC type of the opened program does not support Multi-path PMC.
- Selecting [Device select...] in TOOL menu.

In the [Selection of device] dialog, specify the PMC path you want to connect. When you change the destination, perform communication with the PMC again.

Procedure

1. The [Selection of device] dialog appears. (Only the PCM paths to which you can connect are displayed.)

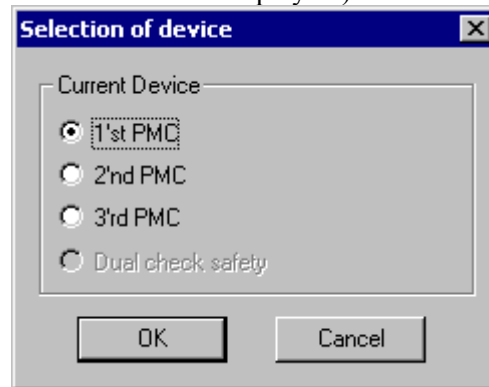

Fig. 3.1.4(b)

2. Select the path you want to connect using the [↑] and [↓] keys.
3. Click the <OK> button.

NOTE

- 1 It is not possible to connect with two or more PMC paths at the same time.
- 2 When PMC type of the opened program support Multi-path PMC and the connection to PMC is started, FANUC LADDER-III is automatically connected with the PMC path of the opened program.
- 3 [Selection of device] dialog is not displayed when there is only one PMC path which can be connected. (When selecting [Device select...] in TOOL menu, [Selection of device] dialog is displayed.)

3.2 CREATING NEW PROGRAMS

This section describes how to create a sequence program (LAD file).

3.2.1 Procedure

- 1 Select [File] - [New Program].
The [New Program] screen appears.

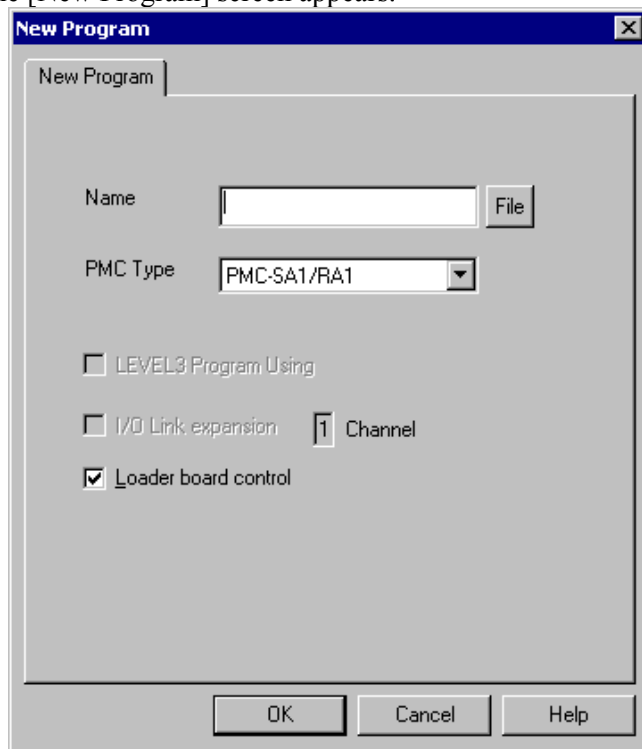

Fig. 3.2.1(a)

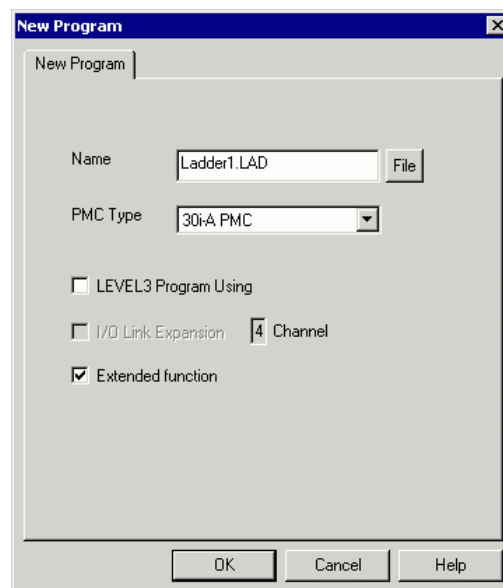

Fig. 3.2.1(b)

- 1-1 Set the necessary data.

Name

Enter the name of a program file you want to create. Use the extension .LAD. You can omit it, however.

PMC Type

Select a PMC model.

LEVEL3 Program Using

Select this item if you want to enable ladder level 3.

I/O Link expansion

Check this check box to enable the I/O Link expansion function after selecting a model that allows multiple channels to be set.

Checking this box displays "2 channels."

When the I/O Link expansion function is enabled, the input/output signals increase from the input signals (X0.0 to X127.7) and output signals (Y0.0 to Y127.7) increase to the input signals (X0.0 to X127.7, X200.0 to X327.7) and output signals (Y0.0 to Y127.7, Y200.0 to Y327.7).

Loader board control

Check this box to create Ladder programs for loader control functions.

Extended function

Check this box to use the extended symbol/comment function.

The extended function allows you to use the following features.

- Ladder edit with symbols
- Local symbol enabled only within a subprogram
- Symbol type setting
- Automatic assignment of R, D, and E addresses

For details, see Chapter 11, "EXTENDED SYMBOL/COMMENT FUNCTION."

NOTE

- 1 The models that allow multiple channels to be set are PMC-SB6 and PMC-SB6 (SFC). When using other models, you cannot check the check box for I/O Link expansion.
- 2 When PMC-QC is used, 2 channels are used even if you do not check the check box for I/O Link expansion.
- 3 Ladder programs for loader board control functions can be created on PMC-SA1 only.

- 2 To create a program, click the <OK> button.
The [Program List] screen appears.
To quit, click the <Cancel> button.

NOTE

A new ladder program is created in the last file folder used for creating or modifying a ladder program.

3.3 OPENING EXISTING PROGRAMS

This section describes how to open an existing sequence program (LAD file).

3.3.1 Procedure

- 1 Select [File] - [Open Program].
The [Open] screen appears.

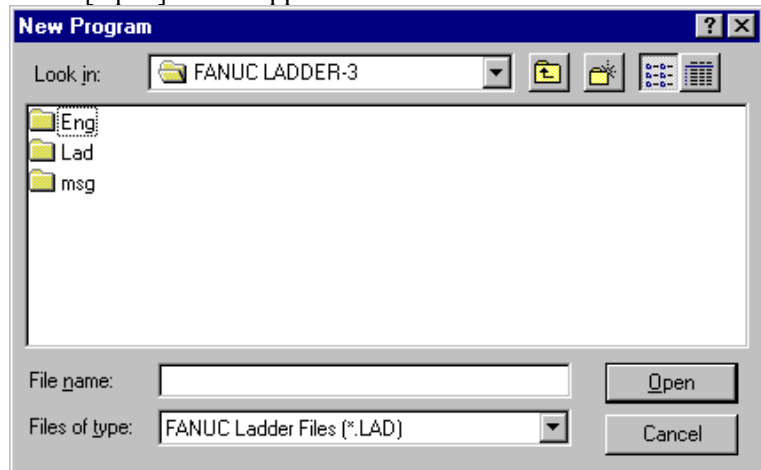

Fig. 3.3.1

- 1-1 Set the necessary data.

File name

Enter the name of the existing program file you want to open. Use the extension .LAD. You can omit it, however.
- 2 To open the program, click the <Open> button.
The [Program List] screen appears.
To quit, click the <Cancel> button.

NOTE

On the [Open] screen, the last file folder used for creating or modifying a ladder program is displayed in [Look in:].

3.3.2 Opening Programs Opened by Another User

This subsection describes access by multiple users to the same file on the network.

- 1 If a user attempts to open a program that is already opened by another user, the [File is opened...] screen appears.

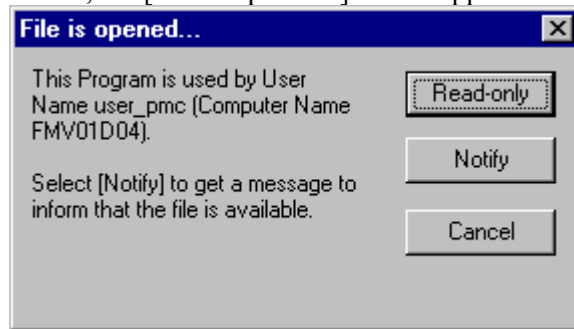

Fig. 3.3.2(a)

<Read-only> button

This button opens a file with the read-only attribute. (See Subsection 3.3.3, "Opening Programs with the Read-only Attribute.")

An opened file cannot be overwritten. An opened file can be saved only by assigning a new name to it.

If an attempt is made to save an opened file by specifying the same name, the following error message appears:

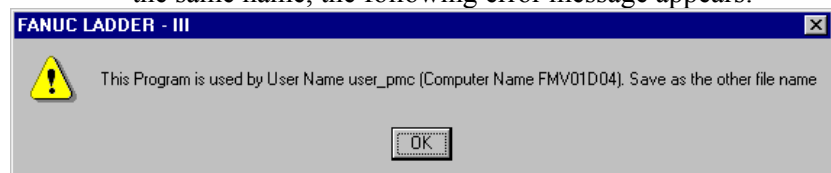

Fig. 3.3.2(b)

<Notify> button

When the first user closes the file, this button displays a notification message.

<Cancel> button

This button cancels an attempt to open a file.

- 2 Clicking the <Notify> button displays the [File is opened... - Waiting...] screen.

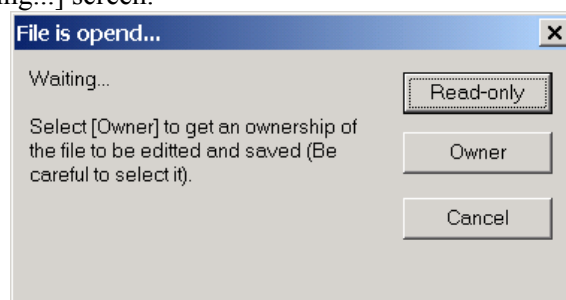

Fig. 3.3.2(c)

<Read-only> button

This button is the same as described in Item 1 above.

<Owner> button

This button opens a file with a privilege. If this button is selected, the first user cannot overwrite the file, but can save the file only by assigning a new name to it.

Be careful when selecting this button. For example, contact the other user(s) using the program.

<Cancel> button

This button is the same as described in Item 1 above.

- 3 If the first user closes the file when another user has clicked the <Notify> button and the [File is opened... - Waiting...] screen is displayed, the following message appears:

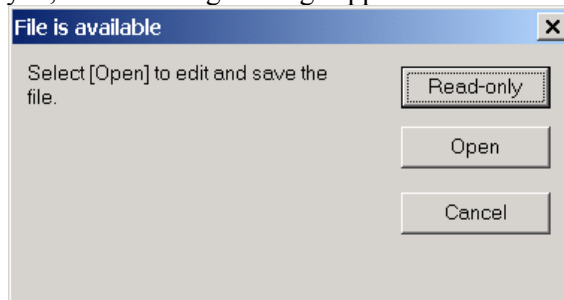

Fig. 3.3.2(d)

<Read-only> button

This button is the same as described in Item 1 above.

<Open> button

This button is the same as the normal button for opening a program.

<Cancel> button

This button is the same as described in Item 1 above.

3.3.3 Opening Programs with the Read-only Attribute

When a program with the read-only attribute is opened, a character string (for read-only indication) is added after the file name in the status bar. Such a file cannot be overwritten, but can be saved only by assigning a new name.

If an attempt is made to save such a file by assigning the same name, the following error message appears:

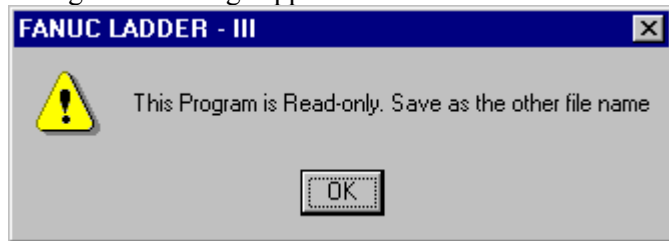

Fig. 3.3.3

3.3.4 Program Importing Function from Memory Card Files

1 Select [File] - [Open Program]. Then the [Open] dialog appears.

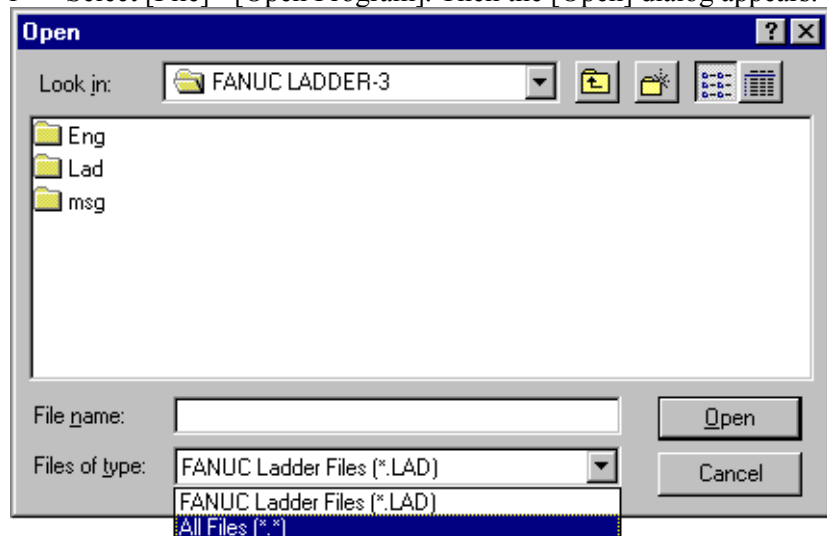

Fig. 3.3.4(a)

- 2 Select "All files" by "File of type" list-box.
- 3 Enter the name of the existing memory card file you want to open.
- 4 Following message appears informing a new program is creating.

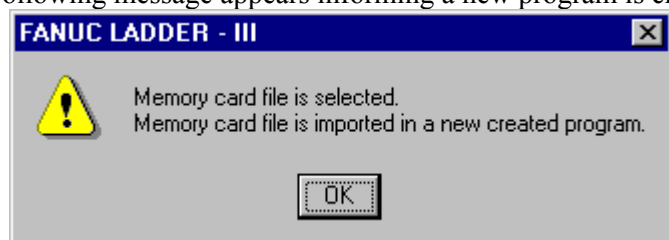

Fig. 3.3.4(b)

- 5 The [New Program] dialog appears. And select appropriate PMC type from the list in the “New Program” dialog, where PMC types that matches with the importing memory card format file are listed.

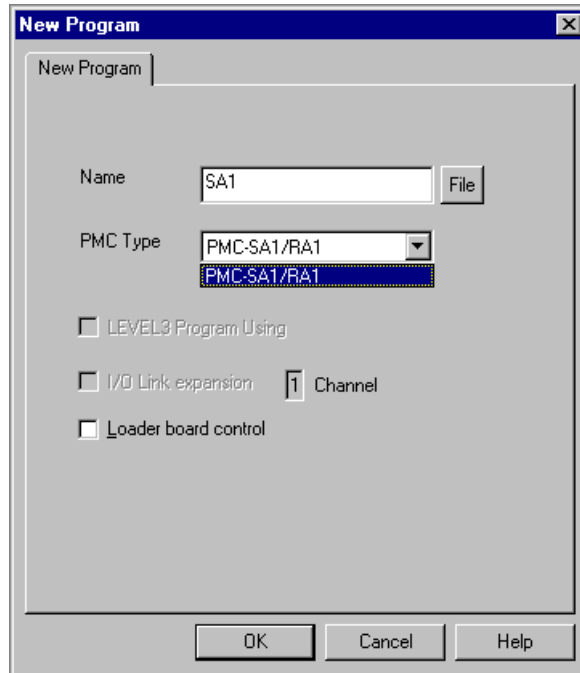

Fig. 3.3.4(c)

Click <OK> button, then importing is completed, and the decompilation is executed.

NOTE

IF wrong PMC type is selected, decompilation may fail. In that case, please select correct PMC type from the list.

3.4 EDITING TITLES

This section describes how to enter a title for a program created by the machine tool builder.

NOTE

Titles can be displayed and edited only when the current programmer mode (offline/online) is offline. To change the programmer mode to offline, select [Ladder] - [Online/Offline].

3.4.1 Procedure

- 1 Double-click the <Title> item in the [Program List] screen. The [Edit Title] screen appears.

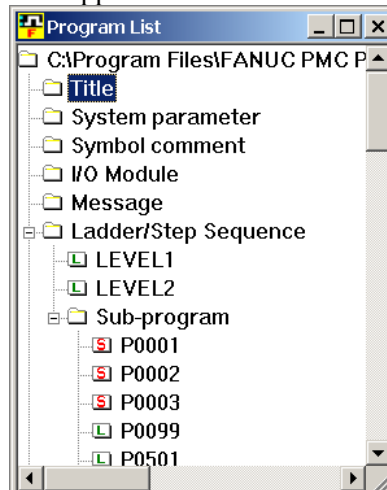

Fig. 3.4.1 (a)

The screenshot shows a window titled 'Edit Title' with a form containing the following fields and values:

Machine Tool Builder Name	FANUC FA SCHOOL
Machine Tool Name	FM16-MB
PMC & NC Name	PMC-RB4
PMC Program No.	FS16
Edition No.	06
Program Drawing No.	B-10106/01
Date Of Programming	94/09/01
Program Designed By	
ROM Written By	
Remarks	STEP SEQUENCE

Fig. 3.4.1 (b)

- 1-1 Set the necessary data. The maximum number of characters that can be entered is as listed below:

Table 3.4.1

Data	Maximum number of characters that can be entered
Machine Tool Builder Name	32
Machine Tool Name	32
PMC & NC Name	32
PMC Program No.	4
Edition No.	2
Program Drawing No.	32
Date Of Programming	16
Program Designed By	32
ROM written by	32
Remarks	32

- 1 To close the [Edit Title] screen, click the <Close> button.



<Close> button

This operation has nothing to do with saving data entered on the [Edit Title] screen.

See Section 3.11, "Saving Programs," for an explanation about how to save data entered on the [Edit Title] screen.

See Section 3.13, "Closing Programs," for an explanation about how to close the sequence program without saving the data entered on the [Edit Title] screen."

3.5 EDITING LADDER DIAGRAMS

This section describes how to edit ladder diagrams.

Two different methods can be used to edit ladder diagrams. The first method is offline editing, in which a personal computer for editing ladder diagrams is used standalone, that is, without being connected to the CNC (PMC). The second method is online editing, in which a personal computer for editing ladder diagrams is connected to the CNC (PMC).

3.5.1 Preparing for Offline Editing

Procedure

1. Check the current programmer mode (offline or online) on the status bar.



Fig. 3.5.1

2. If the current programmer mode is online, select [Ladder] - [Online/Offline] to change the current programmer mode to offline.

3.5.2 Preparing for Online Editing

Starting online editing

Procedure

1. Connect the personal computer to the CNC (PMC) with a data transfer cable. (See Appendix A for an explanation about the data transfer cable.)
2. Check the current programmer mode (offline or online). (See Fig.3.5.1.)
3. If the programmer mode is offline, select [Ladder] - [Online/Offline] or click the [On Line/Off Line Change] button to change the programmer mode to online.
4. When you select a ladder program which is not currently used in the PMC, FANUC LADDER-III automatically stores or loads the ladder program. (See Section 5.3, "AUTOMATIC COMPILATION AND DECOMPILATION," for details.)
5. After that, automatic decompilation is performed and ladder monitoring starts.
6. Then, select [Ladder] - [Ladder Mode] to change the ladder mode (monitor or editor) to editor.

NOTE

- 1 If a ladder program to be edited online does not match one in the PMC, it is impossible to change the ladder mode to edit. Before trying to match the ladder to be edited to that in the PMC, store or load the ladder program to be edited.
- 2 A level 3 program can be added by right-clicking the [Program List] screen and then clicking [Add LEVEL3]. Level 3 programs can be added only when the current programmer mode is offline.

Terminating online editing

Procedure

1. Select [Ladder] - [Online/Offline] or click the [On Line/Off Line Change] button to change the programmer mode to offline. If the ladder program in the PMC is not updated, the following dialog box appears. Update the ladder program.

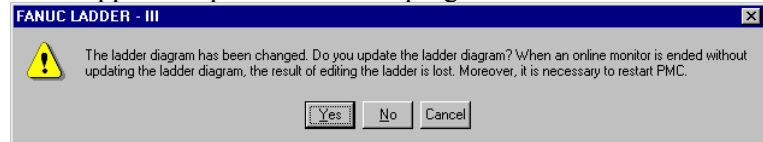

Fig. 3.5.2

2. After that, a dialog box appears, which prompts you to perform decompilation to make the contents of the ladder program in the PMC consistent with those of the ladder program on the personal computer. Perform decompilation.

NOTE

Back up any online-edited ladder program in the PMC to F-ROM of the PMC. (See Section 7.6, "WRITING SEQUENCE PROGRAMS INTO F-ROM," for details.)

3.5.3 Method of Displaying the Ladder Diagram Editing Screen

Procedure

1. Select [View] - [Program List]. The [Program List] screen appears. (Usually, this screen appears automatically when a LAD file is created or opened.)

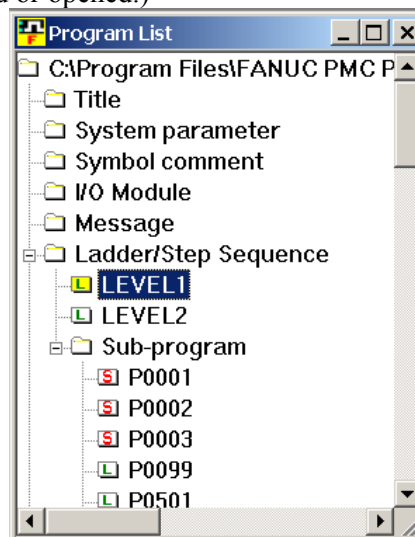



 Ladder program
 Step sequence program

Fig. 3.5.3 (a)

2. On the [Program List] screen, double-click the ladder program you want to edit. Alternatively, select the ladder program and press the [Enter] or [F10] key.

Summary of the ladder diagram editing screen

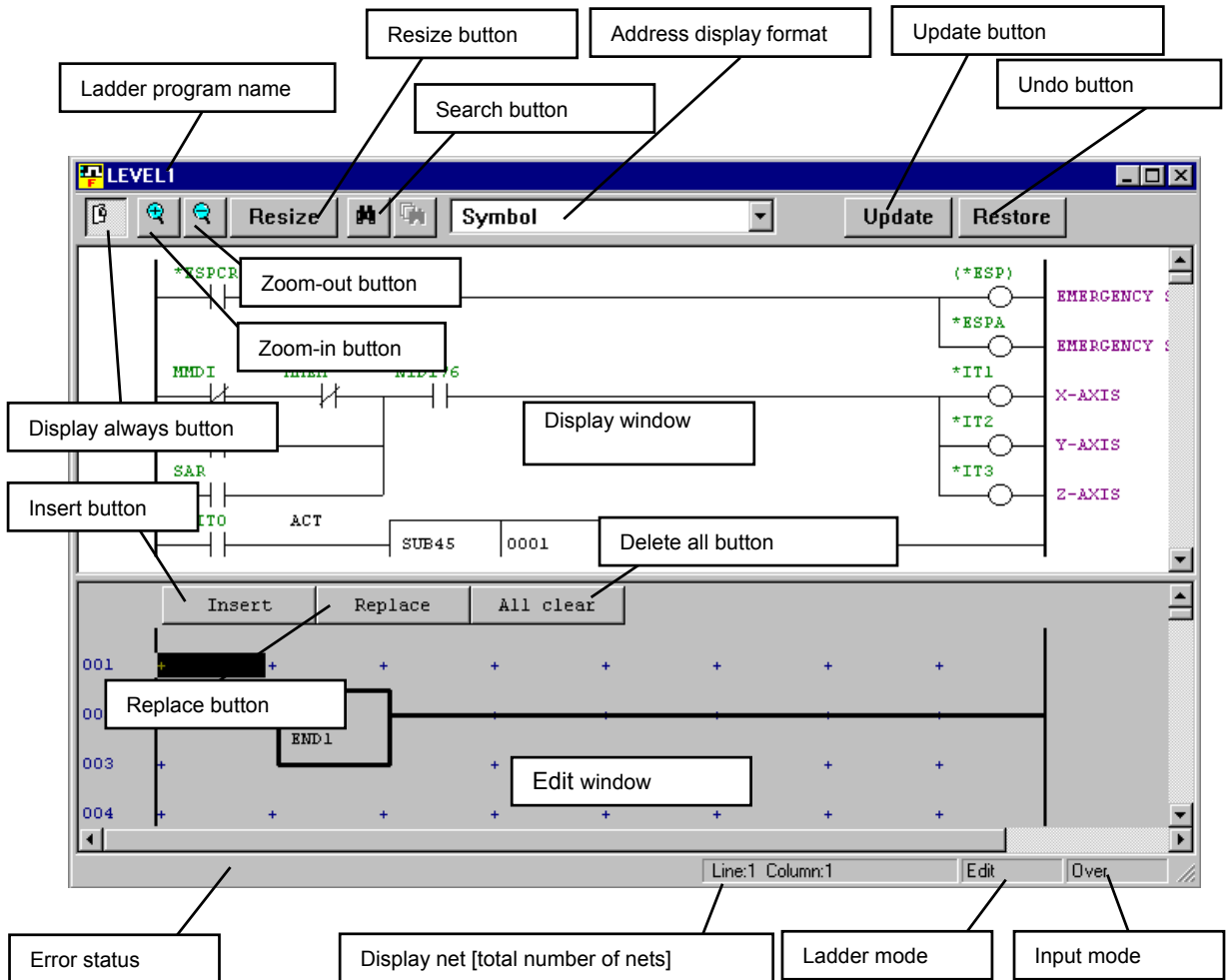

Fig. 3.5.3 (b)

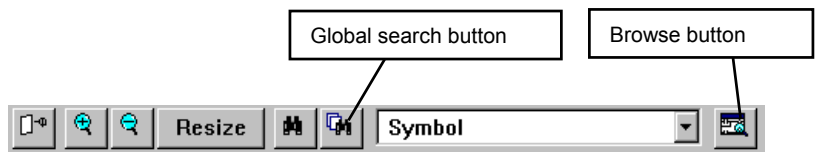

Fig. 3.5.3 (c)

Display window

Ladder program is displayed here.

Edit window

Ladder program is edited here. When the ladder program in this window is inserted or overwrote to the display window, the ladder program in the display window is changed

Insert button

Inserts ladders in the ladder program (display window) to the edit window.

Replace button

Replaces ladders in the ladder program (display window) with those in the edit window.

Erase all button

Erases all ladders from the edit window.

Update button(for online editing only)

Updates the ladders in the PMC with the those in the display window.

Undo button(for online editing only)

Returns the ladders in the display window to the state existing the last time the [Restore] button was pressed. (This operation nullifies all the changes you made after the latest update.

Zoom-in button

Magnifies ladder diagrams.

Zoom-out button

Reduces (shrinks) ladder diagrams.

Resize button

Make the size of a ladder diagram display match the window size.

Search button

Searches the display or edit window for an address or symbol.

Address display format

Specifies the display format for ladders on the display or edit window.

Error status

Displays information about errors.

Display net [total number of nets]

On the display window, displays the range of displayed net numbers and the total number of nets. On the edit window, displays the current cursor position.

Ladder mode

Display the current ladder mode (monitor or edit). To change the ladder mode, select [Ladder] - [Monitor/Editor].

Input mode

To change the input mode (insert or overwrite), press the [Insert] key.

Display always Ctrl+T

Keeps the ladder diagram editing window displayed.
 When the ON, multiple Ladder windows can be displayed at the same time. When the OFF, if another ladder diagram editing window is opened, the displayed window is automatically closed.
 The default is specified by **Always display a window** of the Ladder tab of the option. (choose [Option...] from the [Tool] menu)

Global search Ctrl+F2

Changes the search mode to global search.

Display Ctrl+W

Opens a window for browsing another part of the ladder diagram being edited.

Soft keys

- When the Shift key is not pressed



Fig. 3.5.3 (d)

- When the Shift key is pressed



Fig. 3.5.3 (e)

- When the Ctrl key is pressed



Fig. 3.5.3 (f)

NOTE
 To display soft keys, select [View] - [Softkey].

Edit tool bar



Fig. 3.5.3 (g)

The edit tool bar contains buttons for entering relays and coils, using the mouse. When you click a button on the edit tool bar and move the mouse pointer to the edit window, the mouse pointer changes its shape to the relay or coil corresponding to the clicked button. Under this condition, left-clicking causes the relay or coil to be entered in the current mouse pointer position. Right-clicking resumes the usual mouse pointer shape.

NOTE

- 1 To display the edit tool bar, select [View] - [Edit ToolBar].
- 2 The edit tool bar can be detached from the window to which it belongs and moved to any position on the screen by clicking between its buttons and dragging.

Shortcut keys

Table 3.5.3

Shortcut key	Function
[F2]	Down Coil Search
[Shift] + [F2]	Up Coil Search
[Ctrl] + [F2]	Global Search
[F3]	Search next (downward)
[Shift] + [F3]	Search next (upward)
[Ctrl] + [F3]	Seach Address
[F4]	
[Shift] + [F4]	
[F5]	
[Shift] + [F5]	
[Ctrl] + [F5]	Replace
[F6]	
[Shift] + [F6]	
[F7]	Vertical line (Left side)
[Shift] + [F7]	Vertical line (Right side)
[Ctrl] + [F7]	Insert element
[F8]	Horizontal line
[Shift] + [F8]	Clear element (repeatable)
[Ctrl] + [F8]	Insert line
[F9]	Function instruction
[Shift] + [F9]	Net comment
[Ctrl] + [F9]	Insert Net (forward)
[Ctrl] + [F10]	Insert Net (backward)
[Delete]	Clear element

Table 3.5.3

Shortcut key	Function
[Ctrl] + [A]	Edit – Select all
[Ctrl] + [C]	Edit – Copy
[Ctrl] + [D]	Edit – Address display switch
[Ctrl] + [F]	Edit – Search
[Ctrl] + [G]	Edit – Jump to specified net number
[Ctrl] + [H]	Edit – Replace
[Ctrl] + [R]	Restore (for online editing only)
[Ctrl] + [T]	Display always
[Ctrl] + [U]	Update (for online editing only)
[Ctrl] + [V]	Edit - Paste
[Ctrl] + [W]	Display browse window
[Ctrl] + [Y]	Redo
[Ctrl] + [Z]	Undo
[Home]	Display left end
[End]	Display right end
[Ctrl] + [Home]	Jump to beginning
[Ctrl] + [End]	Jump to end
[Ctrl] + [↑]	Jump to previous net
[Ctrl] + [↓]	Jump to next net
[Ctrl] + [PageUp]	Jump to next page
[Ctrl] + [PageDown]	Jump to previous page

Context menu

Right-clicking the ladder editing screen or pressing [Shift]+[F10] displays the context menu. See Table 3.5.3 for details of each function.

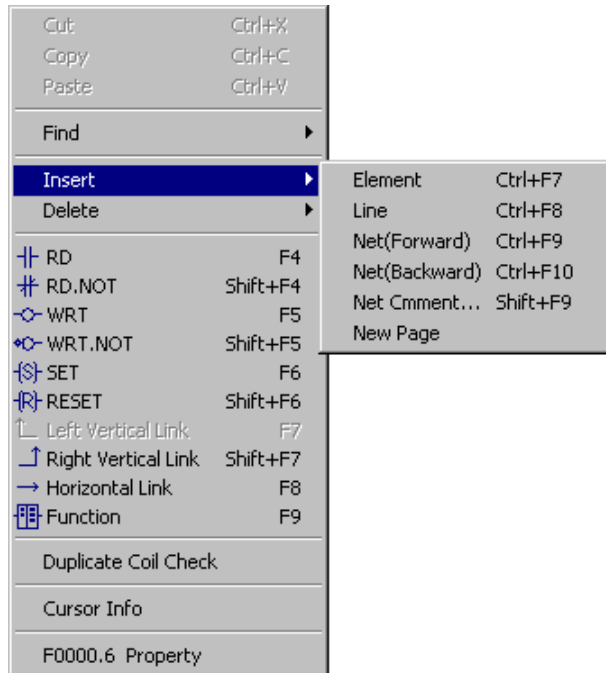

Fig. 3.5.3(h)

3.5.4 Changing Ladder Programs

This subsection describes how to modify ladder programs.

NOTE

- 1 To modify a ladder program, copy ladders from the display window to the edit window. Then, change them on the display window and substitute the ladders on the display window with those modified on the edit window.
- 2 If there is a ladder error in the ladders on the edit window, it is impossible to select the <Insert> and <Replace> buttons.
- 3 Double-clicking a ladder on the display window causes the ladders in the same net as the clicked ladder to be copied to the edit window.

Procedure

1. On the display window, position the cursor to the ladder you want to modify, using the cursor control keys.

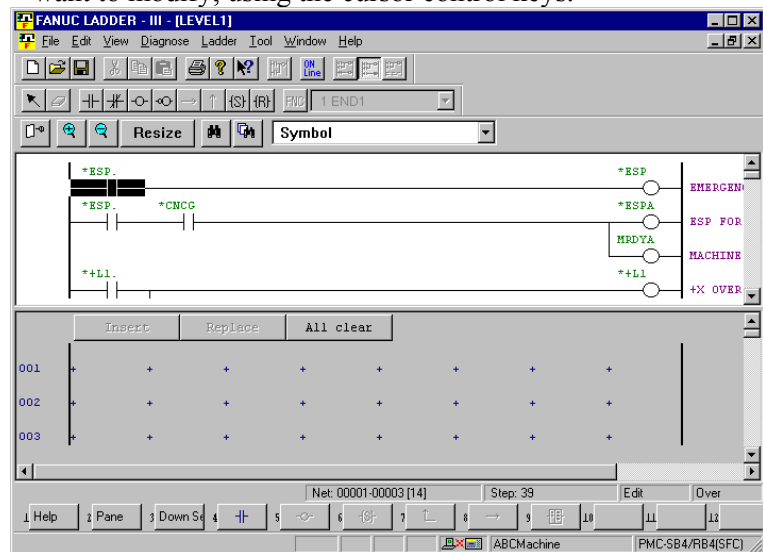

Fig. 3.5.4 (a)

2. Press the [Enter] key. (Alternatively, double-click the ladder you want to modify.)

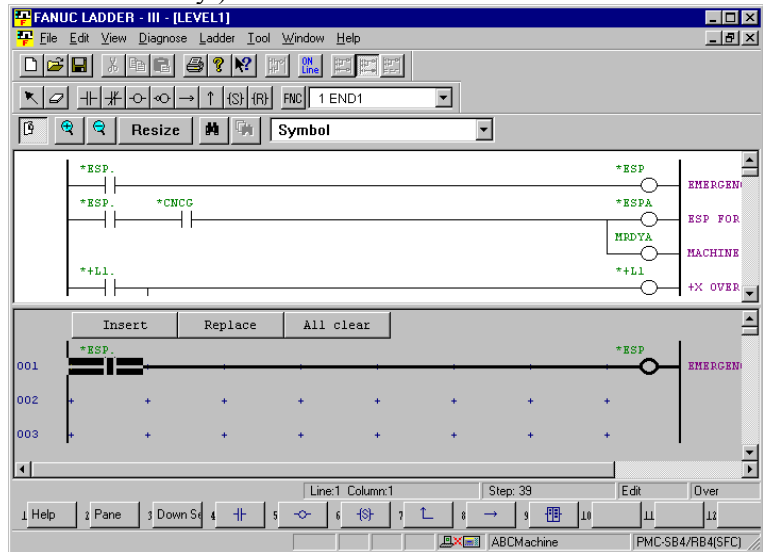

Fig. 3.5.4 (b)

3. Modify the ladder on the edit window.
For an explanation of how to operate ladders on the edit window, see the subsections listed below:

Table 3.5.4

Operation	Subsection
Entering basic instructions	3.5.6 "Entering Basic Instructions"
Entering horizontal lines	3.5.8 "Entering Horizontal Lines"
Entering and deleting vertical lines	3.5.9 "Entering and Deleting Vertical Lines"
Entering function instructions	3.5.7 "Entering Function Instructions"

- After you finished modifying ladders, click the <Replace> button.

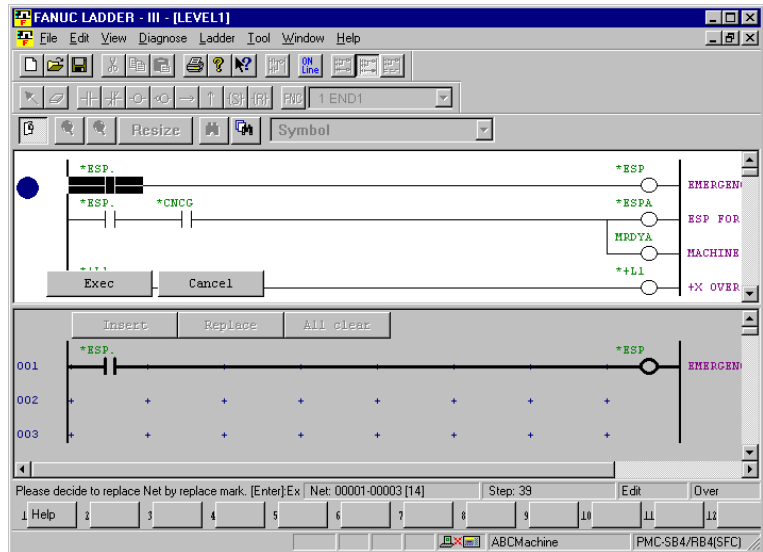

Fig. 3.5.4 (c)

- Select the replacement position, using the [↓] key or [↑] key, and then click the <Exec> button

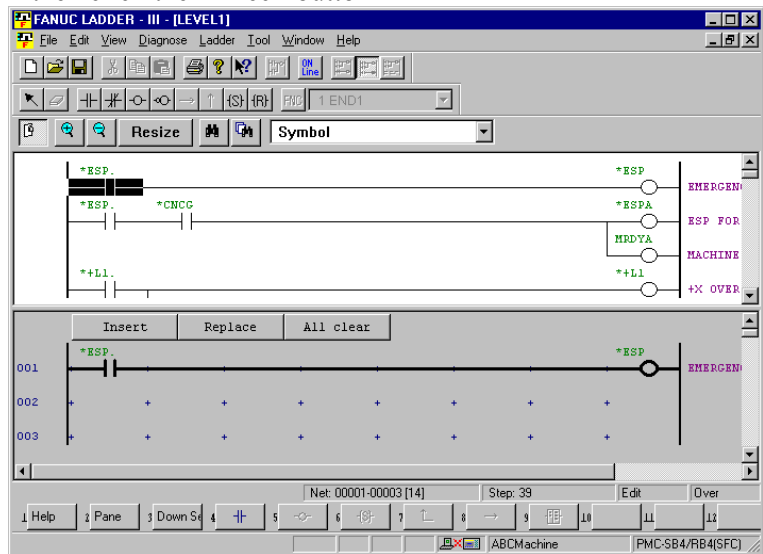

Fig. 3.5.4 (d)

3.5.5 Inserting Ladders from the Edit Window into a Ladder Program

This subsection describes how to insert ladders from the edit window into a ladder program (on the display window).

NOTE

- 1 If there is a ladder error in a ladder in the edit window, it is impossible to select the <Insert> and <Replace> buttons.
- 2 Double-clicking a ladder in the display window causes the ladders in the same net as the clicked ladder to be copied to the edit window.

Procedure

1. In the edit window, create the ladders you want to insert into a ladder program.

For an explanation about how to operate the ladders on the edit window, see the subsections listed below:

Table 3.5.5

Operation	Subsection
Entering basic instructions	3.5.6 "Entering Basic Instructions"
Entering horizontal lines	3.5.8 "Entering Horizontal Lines"
Entering and deleting vertical lines	3.5.9 "Entering and Deleting Vertical Lines"
Entering function instructions	3.5.7 "Entering Function Instructions"

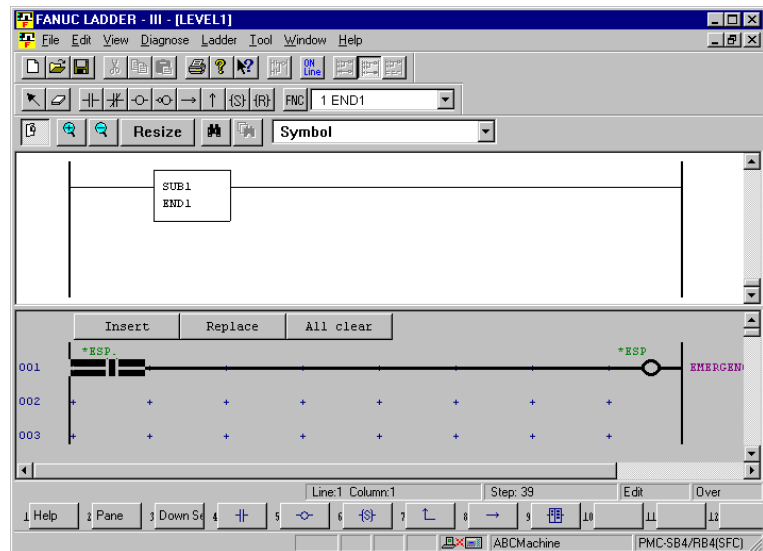

Fig. 3.5.5 (a)

- Click the <Insert> button.

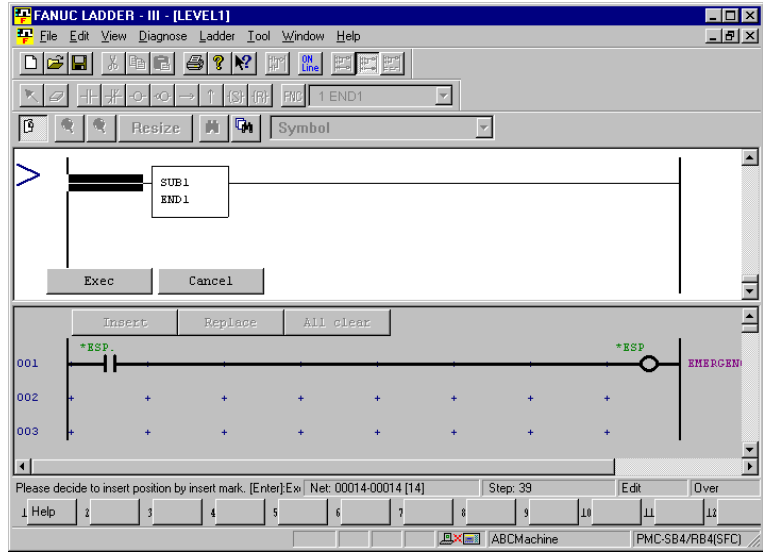

Fig. 3.5.5 (b)

- Select the insertion position, using the [↓] key or [↑] key, and then click the <Exec> button.

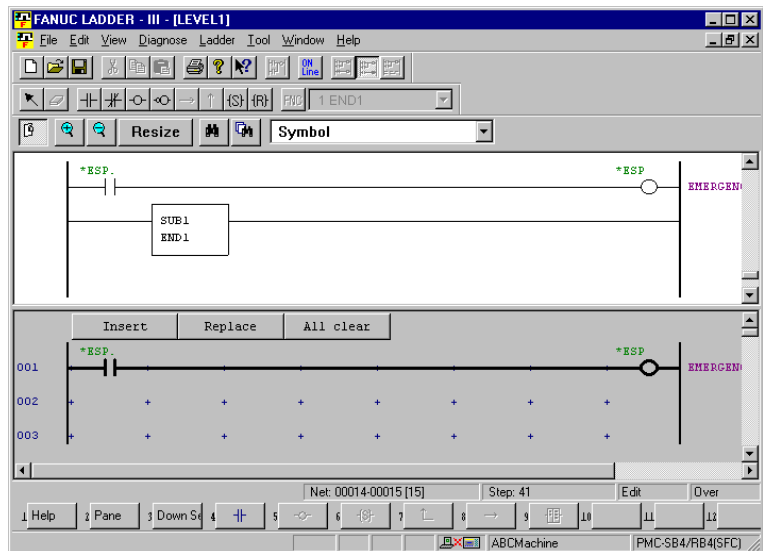

Fig. 3.5.5 (c)

3.5.6 Entering Basic Instructions

This subsection describes how to enter basic instructions (relays and coils) in the edit window.

Procedure

- 1 Position the cursor to the point where you want to enter a basic instruction, using the cursor control keys. (Alternatively, click the point.)

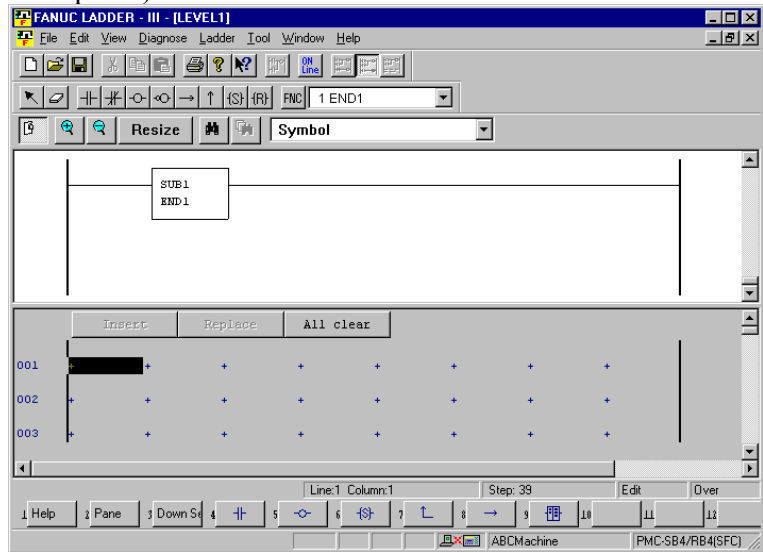

Fig. 3.5.6 (a)

- 2 Press the key that corresponds to the basic instruction you want to enter.

Table 3.5.6

Key	Basic instruction
[F5]	
[Shift] + [F5]	
[F6]	
[Shift] + [F6]	
[Shift] + [F7]	
[Shift] + [F8]	

- 3 Position the cursor to the basic instruction you entered, using the cursor control keys, and then press the [Enter] key. (Alternatively, double-click the basic instruction.)

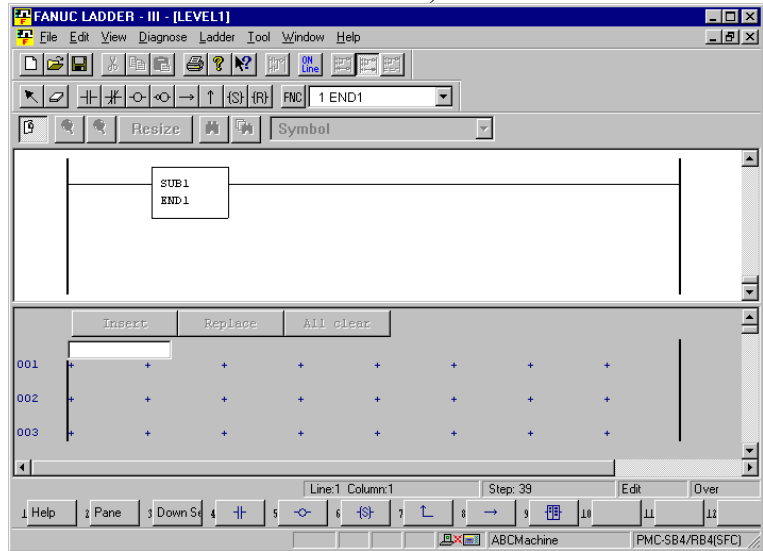

Fig. 3.5.6 (b)

- 4 Enter an address or symbol, and then press the [Enter] key.

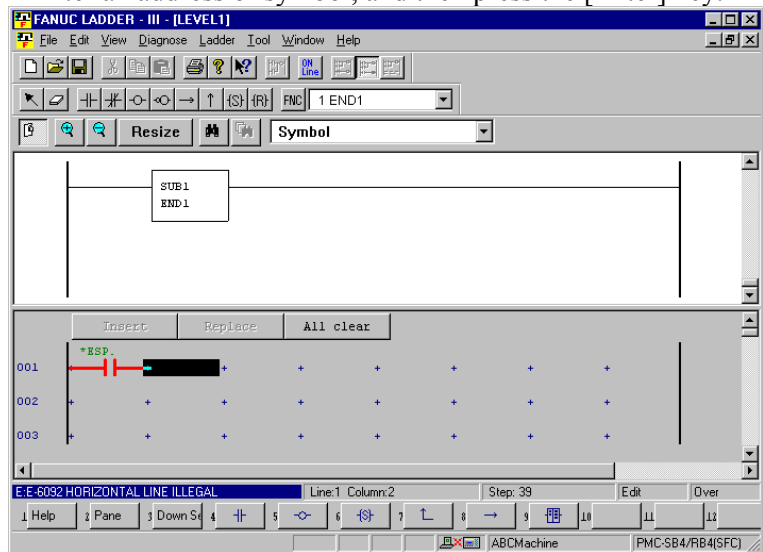

Fig. 3.5.6 (c)

After entering an address or symbol, you can enter basic instructions using function keys.

Procedure

- 1 Position the cursor to the point where you want to enter a basic instruction, using the cursor control keys. (Alternatively, click the point.)

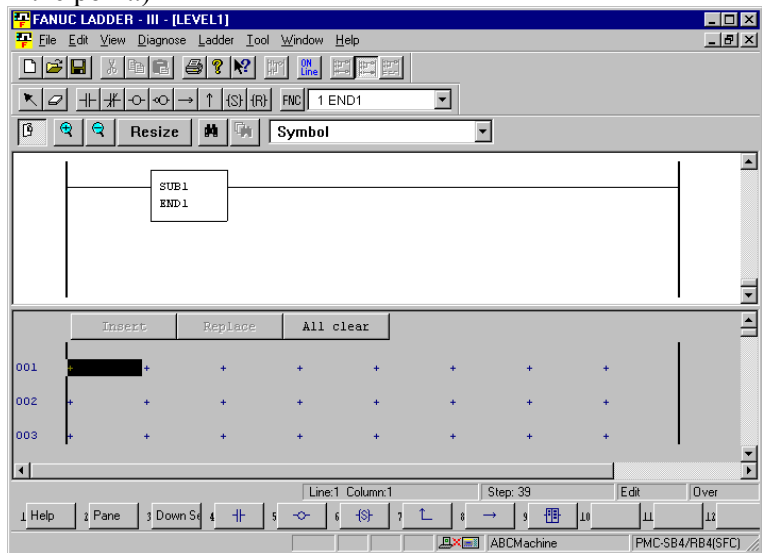

Fig. 3.5.6 (d)

- 2 Enter an address or symbol.

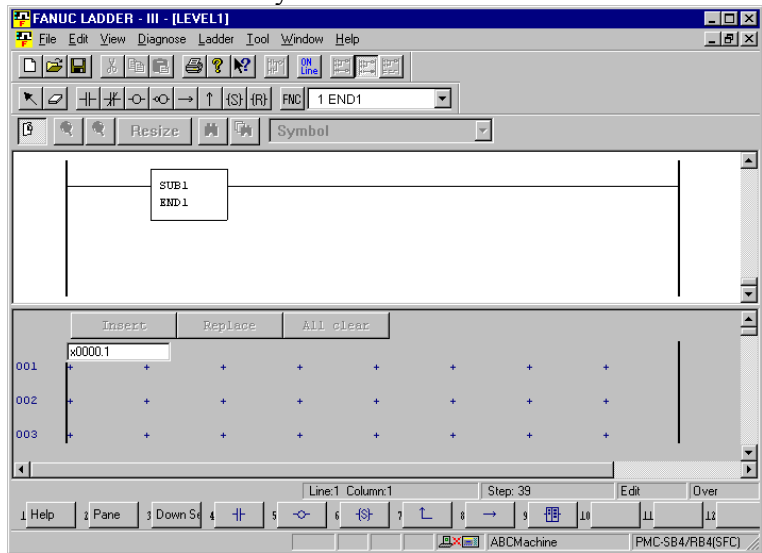

Fig. 3.5.6 (e)

- 3 Press the key that corresponds to the basic instruction you want to enter. (See Table 3.5.6.)

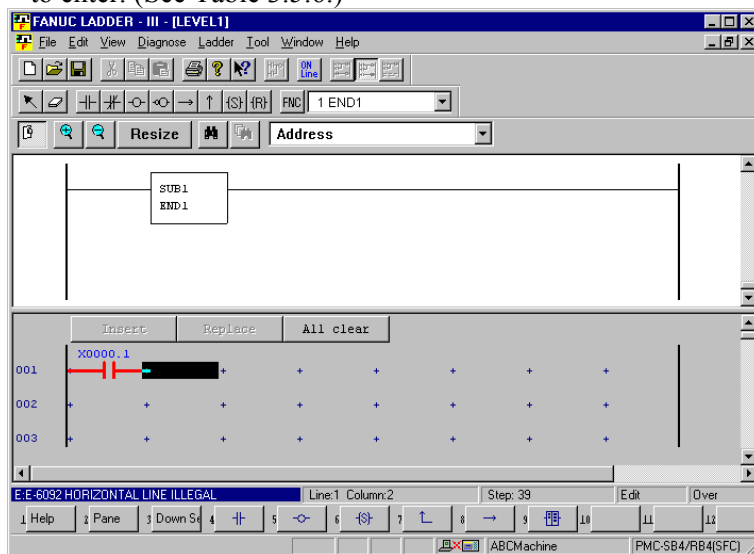

Fig. 3.5.6 (f)

3.5.7 Entering Function Instructions

This subsection describes how to enter function instructions in the edit window.

Procedure

- 1 Position the cursor to the point where you want to enter a function instruction, using the cursor control keys. (Alternatively, click the point.)

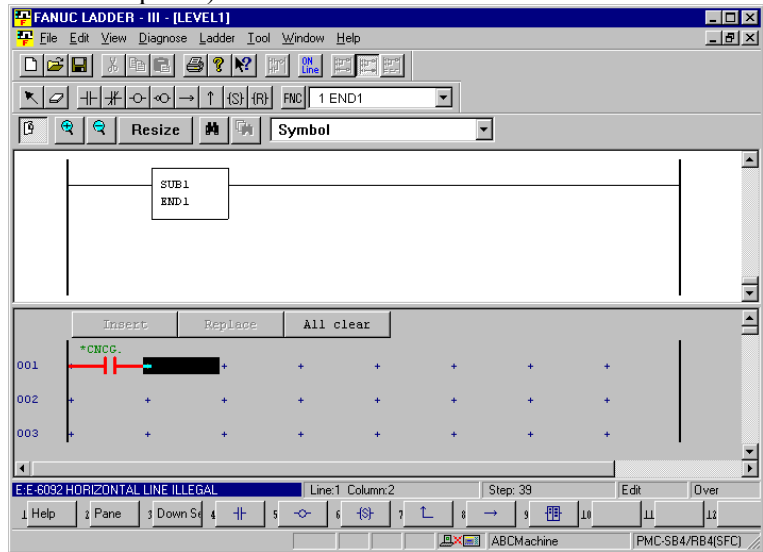

Fig. 3.5.7 (a)

- 2 Press the [F9] key to display the [Select function] dialog box.

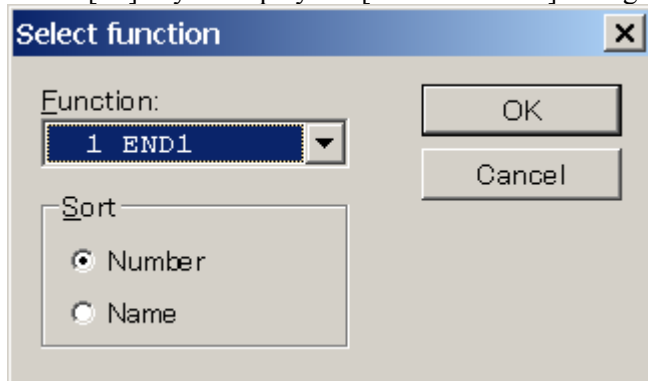

Fig. 3.5.7 (b)

- 3 Select the function instruction you want to enter, and then press the <OK> button.

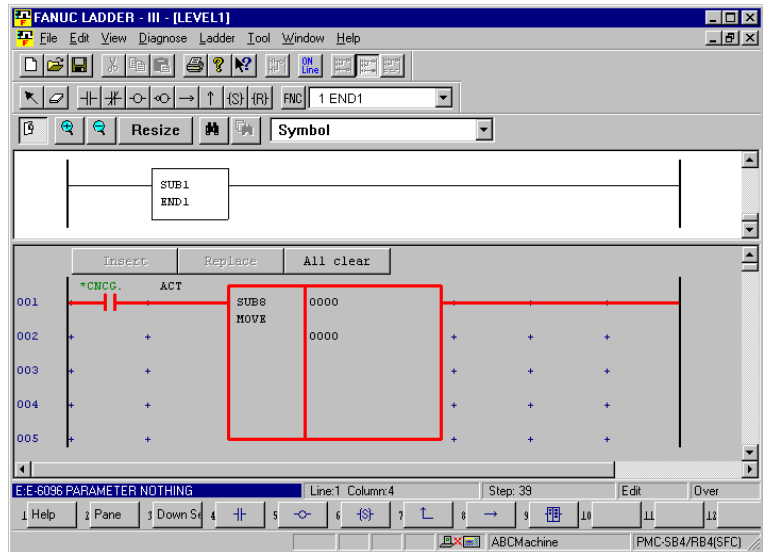

Fig. 3.5.7 (c)

- 4 Enter the parameters for the instruction you entered.

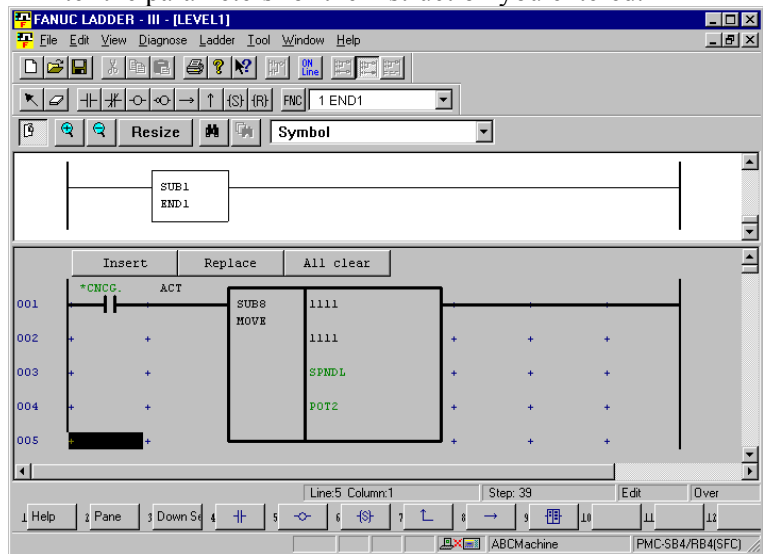

Fig. 3.5.7 (d)

After entering a function instruction number or name, you can enter a function instruction using the [F9] key.

Procedure

- 1 Position the cursor to the point where you want to enter a function instruction, using the cursor control keys. (Alternatively, click the point.)

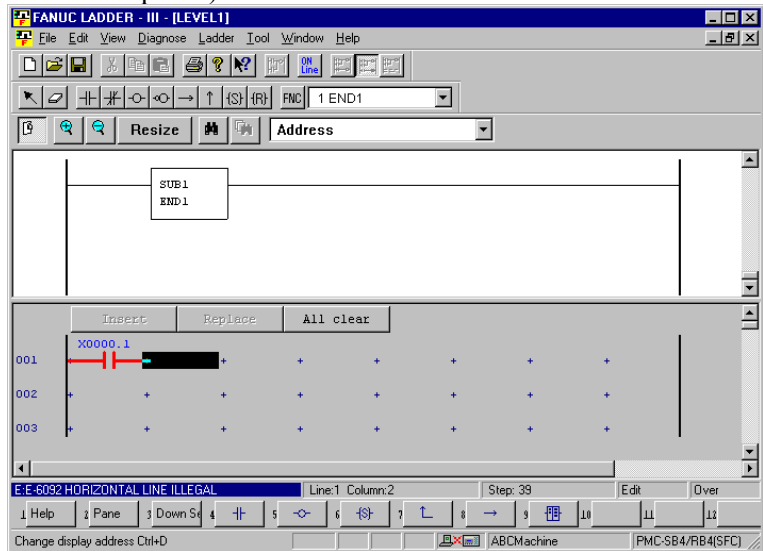

Fig. 3.5.7 (e)

- 2 Enter a function instruction number or name.

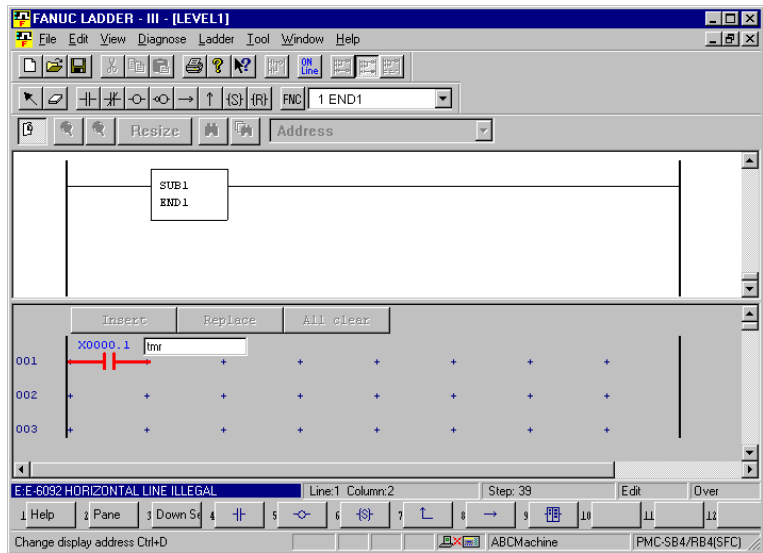

Fig. 3.5.7 (f)

3 Press the [F9] key.

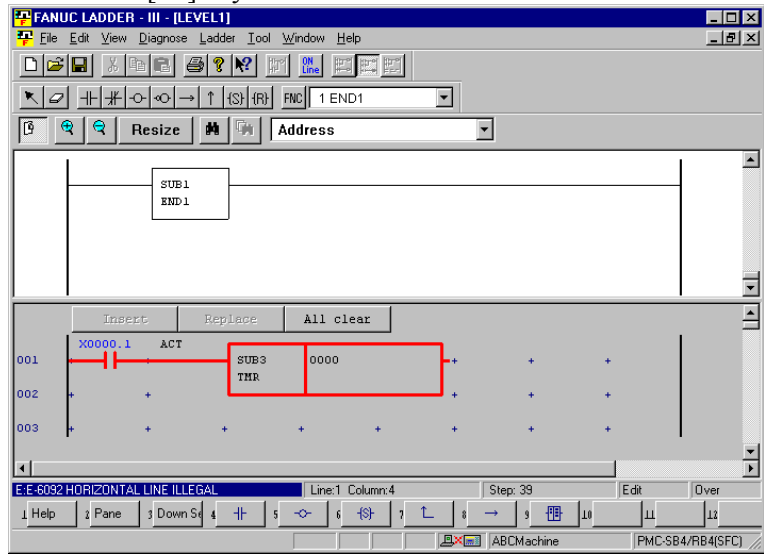

Fig. 3.5.7 (g)

3.5.8 Entering Horizontal Lines

This subsection describes how to enter horizontal lines in the edit window.

Procedure

1. Position the cursor to the point where you want to enter a horizontal line. (Alternatively, click the point.)

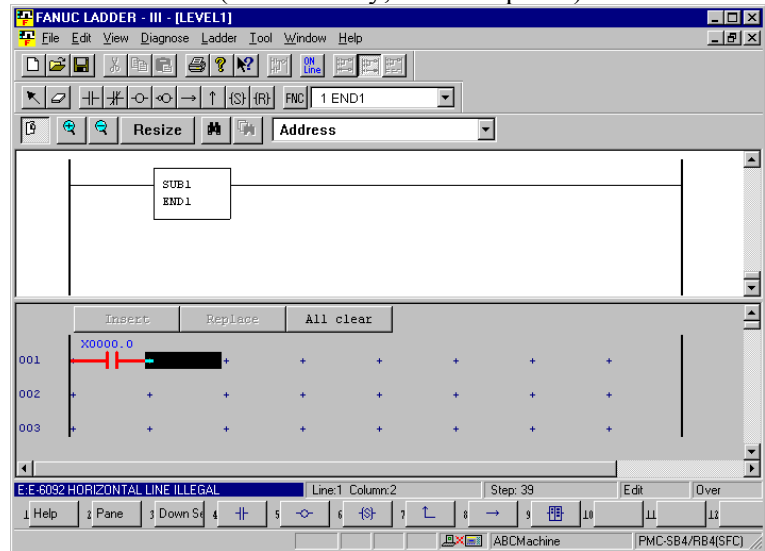

Fig. 3.5.8 (a)

2. Press the [F8] key.

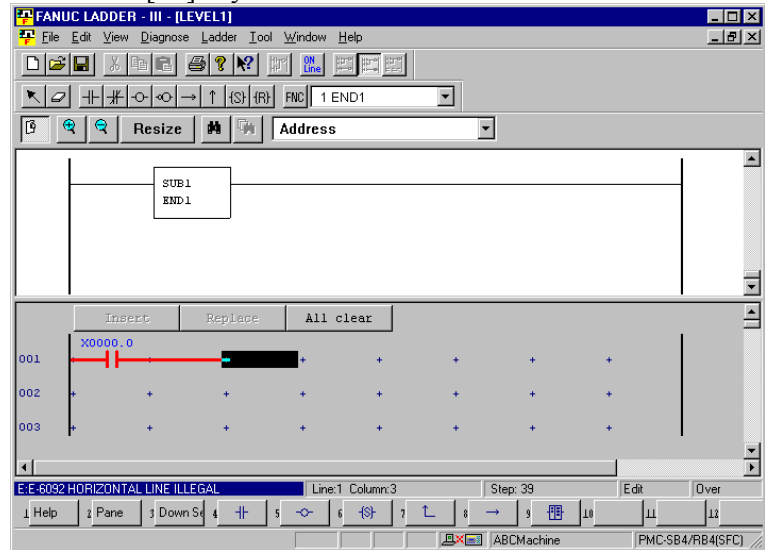

Fig. 3.5.8 (b)

3.5.9 Entering and Deleting Vertical Lines

This subsection describes how to enter and delete vertical lines in the edit window.

Procedure

1. Position the cursor to the point where you want to enter a vertical line, using the cursor control keys. (Alternatively, click the point.)

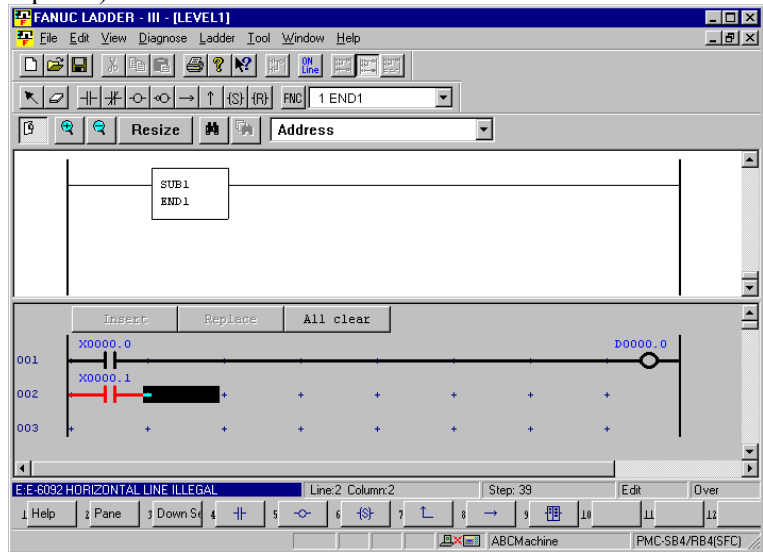

Fig. 3.5.9 (a)

2. Press the [F7] key, and then press the [↑] or [↓] key. The vertical line is entered. (To delete the vertical line, hold down the [Shift] key and then press the [↑] or [↓] key.)

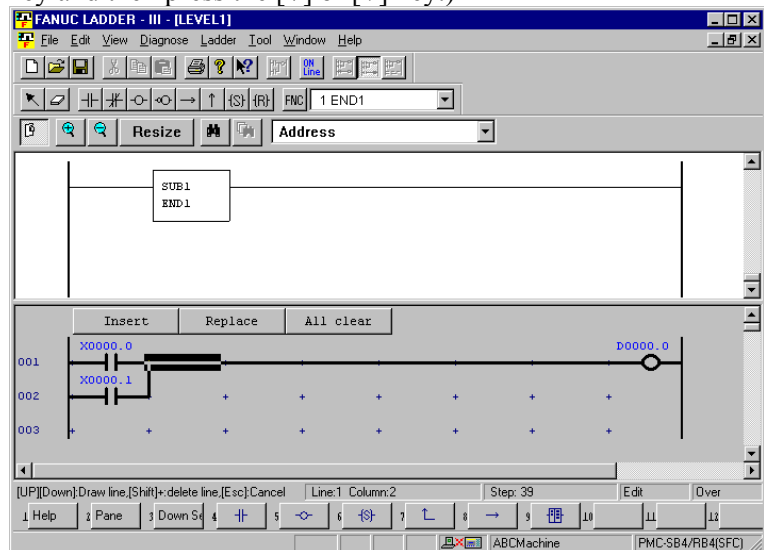

Fig. 3.5.9 (b)

3.5.10 Adding Ladder Subprograms

This subsection describes how to add ladder subprograms.

Procedure

1. Right-click on the program list screen, and then click [Add sub-program F9].

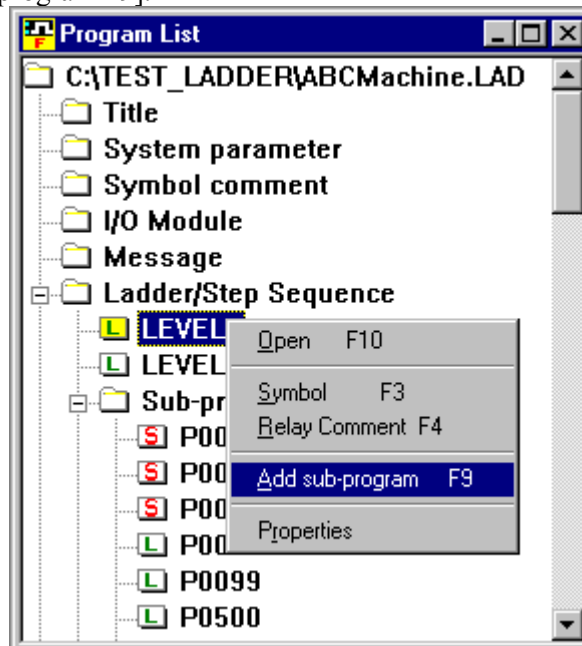

Fig. 3.5.10 (a)

2. The [Add sub-program] dialog box appears.

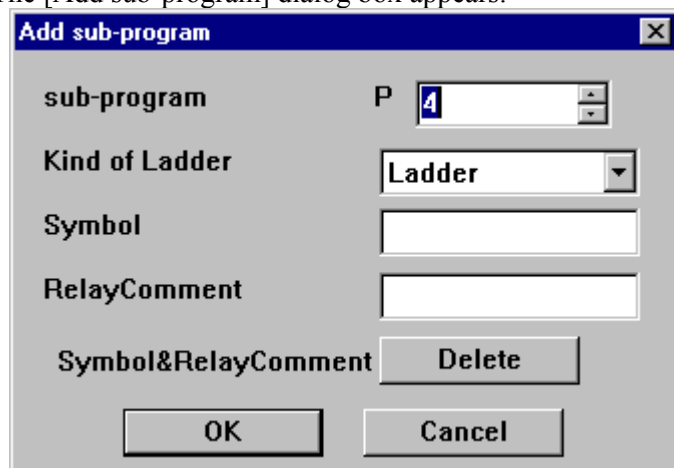

Fig. 3.5.10 (b)

3. Enter [sub-program].
4. Select [Ladder] from [Kind of Ladder].
5. Enter [Symbol] and [RelayComment], and then click the <OK> button.
6. The subprogram is added, and the screen for the added ladder program appears.

3.5.11 Deleting Ladder Subprograms

This subsection describes how to delete subprograms.

Procedure

1. On the program list screen, position the pointer to the subprogram you want to delete and right-click. Then, click [Delete sub-program F6].

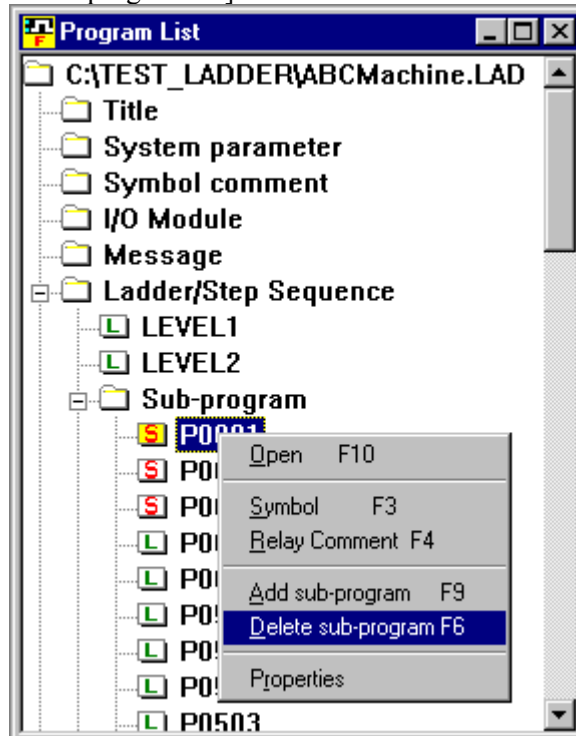

Fig. 3.5.11 (a)

2. The following dialog box appears. To delete the subprogram, click <Yes>.

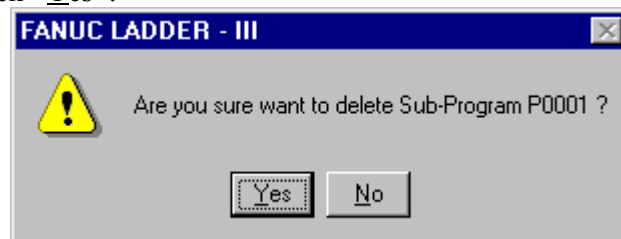

Fig. 3.5.11 (b)

3. Delete the symbols and relay comments from a subprogram.

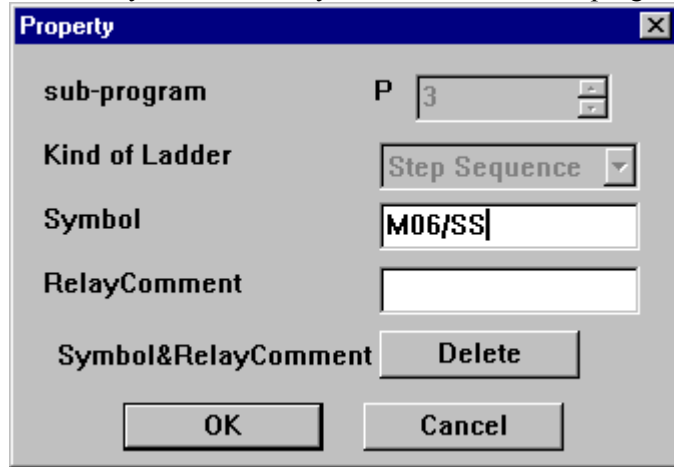

Fig. 3.5.11 (c)

- 3-1 Click the right mouse button and select [Property].
- 3-2 Click the [Symbol&RelayComment Delete] button.

3.5.12 Editing Net Comments

This subsection describes how to edit net comments.

Procedure for adding net comments

Procedure

1. In the display window, position the mouse pointer to the point where you want to add a net comment, and then right-click.

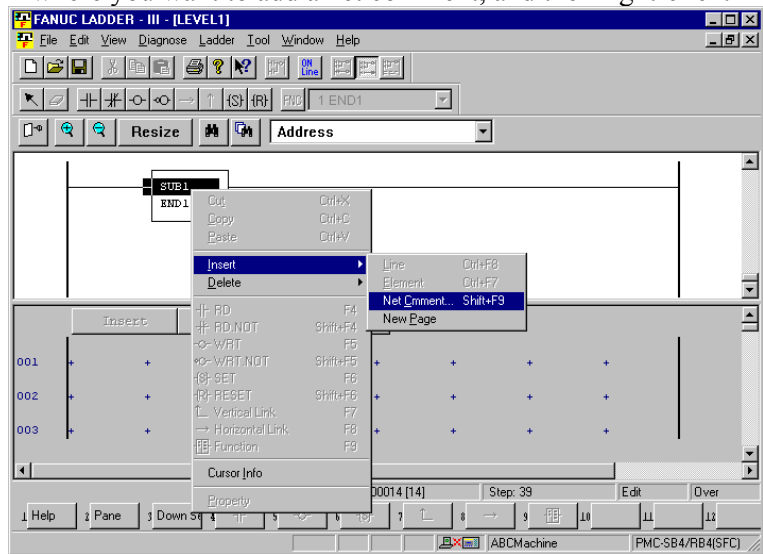

Fig. 3.5.12 (a)

2. Select [Insert] - [Net comment] , and then enter a net comment.

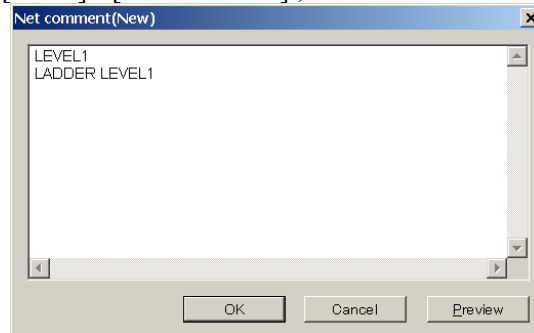

Fig. 3.5.12 (b)

To check the number of characters in the entered net comment, press the <Preview> button.

The preview screen appears.

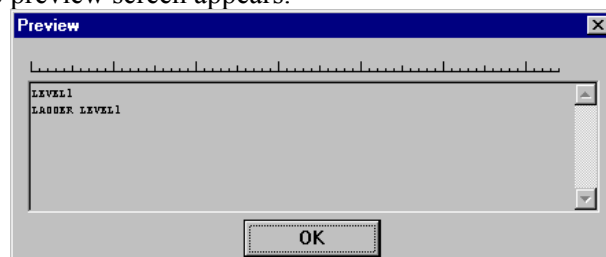

Fig. 3.5.12 (c)

- After you finish entering the net comment, press the <OK> button.

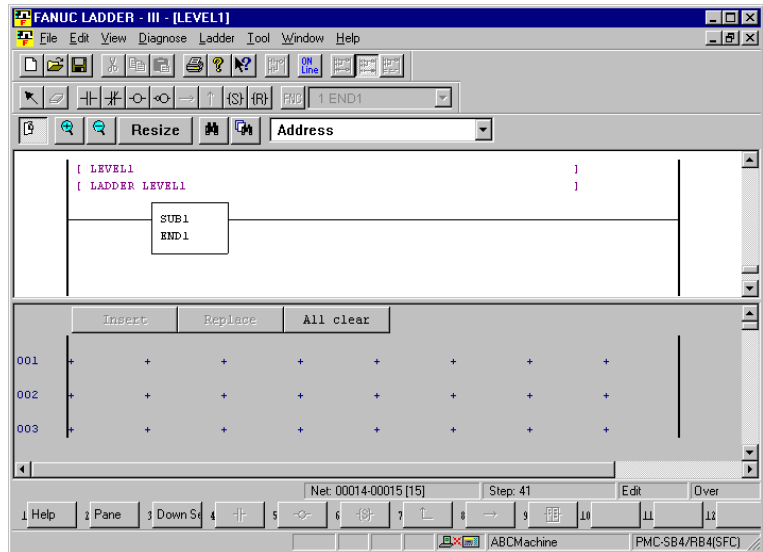

Fig. 3.5.12 (d)

Procedure for editing net comments

Procedure

- In the display window, double-click the net comment you want to modify.
The [Net comment] screen appears.

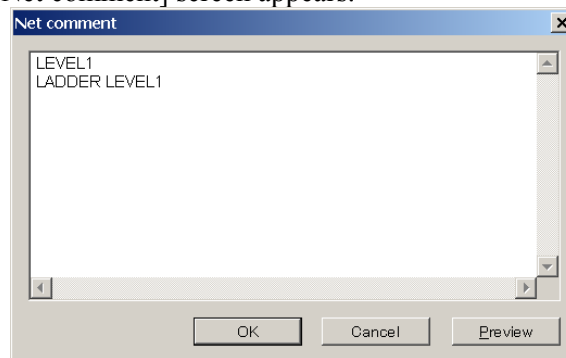

Fig. 3.5.12 (e)

- Edit the character strings for the net comment. After you finish editing, press the <OK> button. The net comment in the display window is updated.

3.5.13 Deleting Net Comments

This subsection describes how to delete net comments.

Procedure

1. In the display window, position the mouse pointer to the net comment you want to delete, and then right-click.

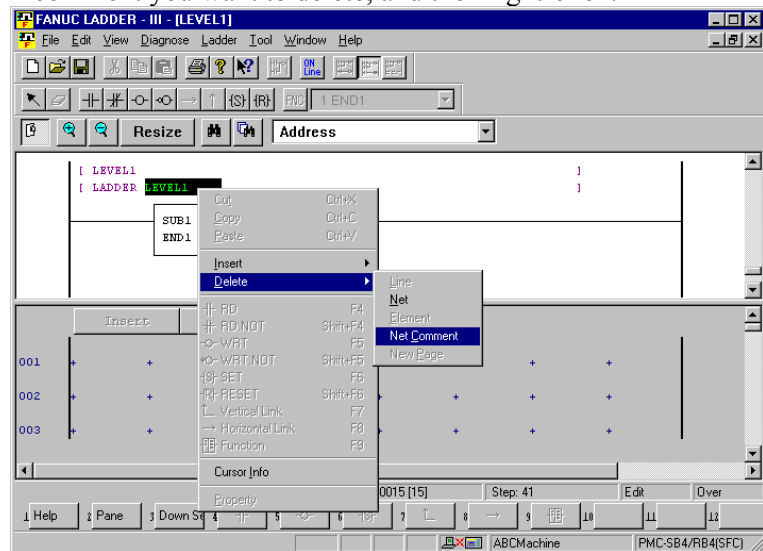

Fig. 3.5.13 (a)

2. Select [Delete] - [Net comment].
3. The following dialog box appears. To delete the net comment, select <OK>.

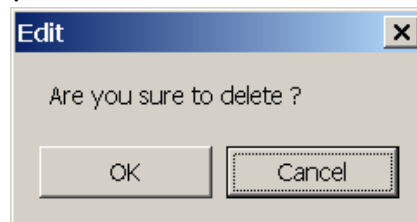

Fig. 3.5.13 (b)

3.5.14 Adding Page Breaks

This subsection describes how to add page breaks.

Procedure

1. In the display window, position the mouse pointer to the point where you want to add a page break, and then right-click.

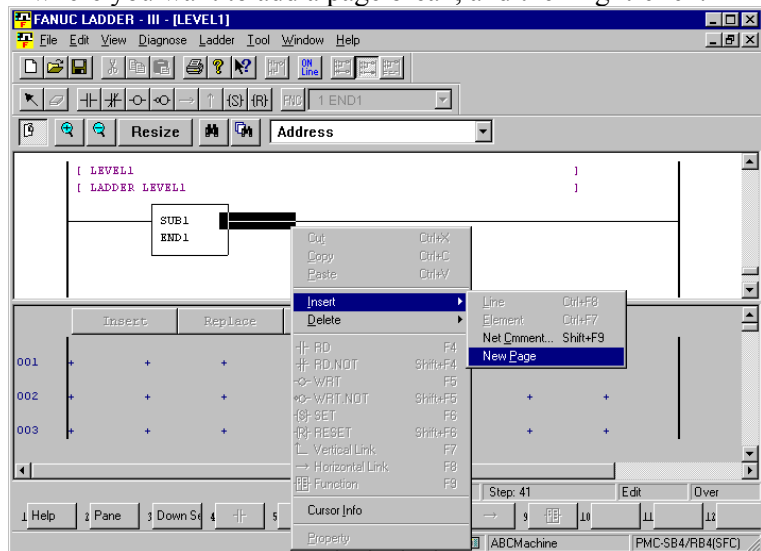

Fig. 3.5.14

2. Select [Insert] - [New page]. The page break is added.

3.5.15 Deleting Page Breaks

This subsection describes how to delete page breaks.

Procedure

1. In the display window, position the mouse pointer to the page break you want to delete, and then right-click.

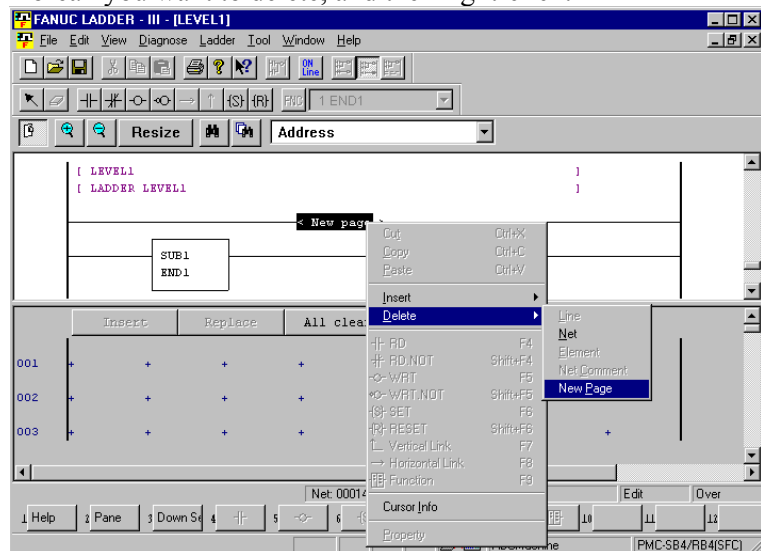

Fig. 3.5.15 (a)

2. Select [Delete] - [New page].
3. The following dialog box appears. To delete, select <OK>.

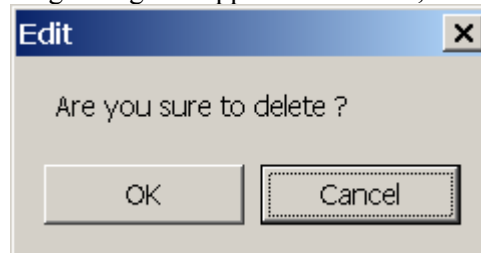

Fig. 3.5.15 (b)

3.5.16 Deleting Nets

This subsection describes how to delete nets.

Procedure

1. In the display window, select the range of nets you want to delete, using the mouse or cursor control keys.
2. Position the mouse pointer to the selected range, and then right-click.

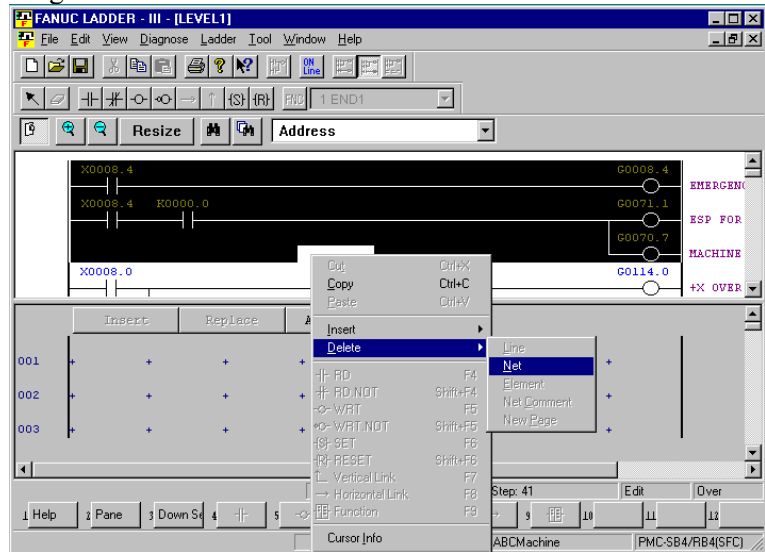

Fig. 3.5.16 (a)

3. Select [Net] from [Delete].
4. The following dialog box appears. To delete it, select <OK>.

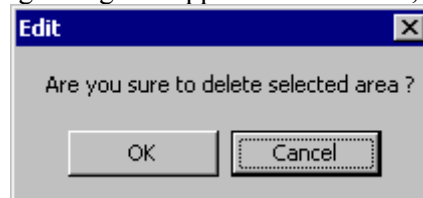

Fig. 3.5.16 (b)

3.5.17 Search

This subsection describes the ladder program search function.

Procedure

1. Choose [Search] from the [Edit] menu.
The [Search] screen appears.

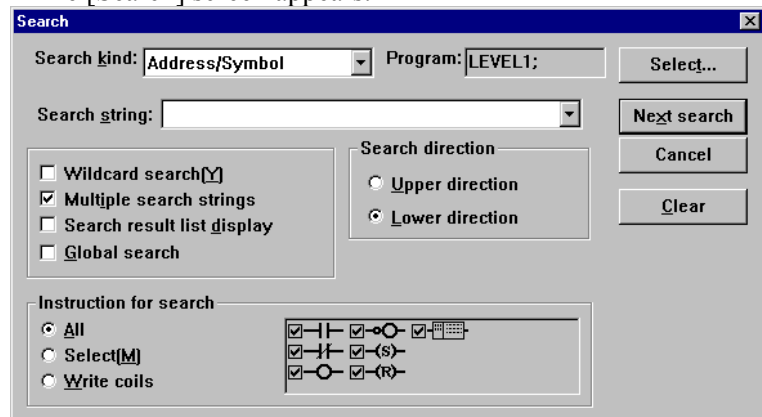

Fig. 3.5.17(a)

- 1-1 **Search kind**
Select Address/Symbol or Functional instruction.
- 1-2 **Program**
Click the <Select> button to open the [Program select dialog] screen, then select a search target program.
- 1-3 **Global search**
Check this check box to select multiple search target programs at a time.

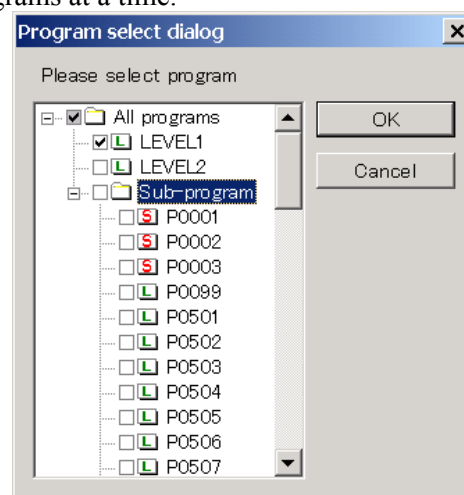

Fig. 3.5.17(b)

2. When Address/Symbol is selected

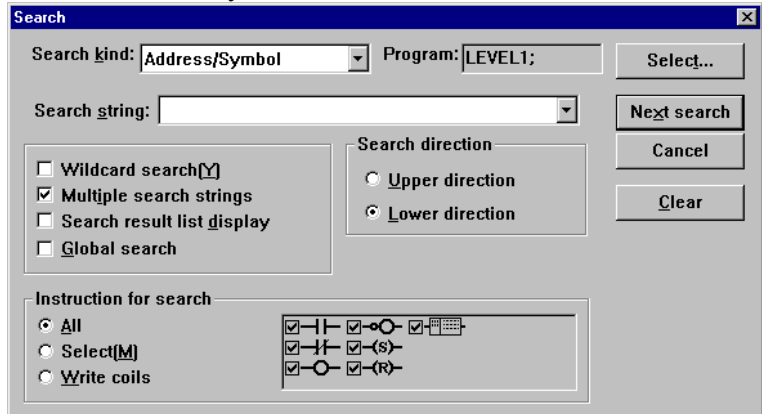

Fig. 3.5.17(c)

2-1 **Instruction for search**

Check search target instructions.

All

Searches for all types of instructions.

Select

Select a desired instruction you want to search for.

Write coils

Searches for only write coils.

3. When Function instruction is selected

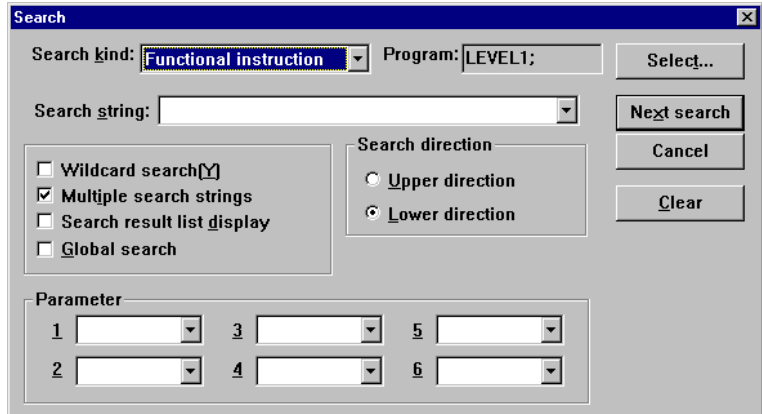

Fig. 3.5.17(d)

3-1 **Parameter**

Enter parameters as search conditions according to Functional instruction selected in Search kind.

4. Specify a character string you want to search for.

4-1 **Search string**

Enter a character string to be searched for.

In a character string to be found, two types of wildcards can be used: a question mark (?) and an asterisk (*). A wildcard substitutes for one or multiple characters.

A question mark (?) is used to represent one character. This wildcard can be used more than once to represent characters.

An asterisk (*) represents zero or more characters.

Multiple addresses can be specified by delimiting them from each other by a comma (,) or semicolon (;). (Example: Y0.0;X0.0)

4-2 **Wildcard search**

Check this check box if a specified character string to be found includes wildcards.

4-3 **Multiple search strings**

Check this check box to specify multiple character strings to be searched for.

4-4 **Search direction**

Select Upper direction or Lower direction as the direction of search.

4-5 **Search result list display**

Check this check box to display the search results on the [Search result list (call)] screen in a batch.

The [Search result list (call)] screen displays program numbers, net numbers, ladder diagrams, and coil comments.

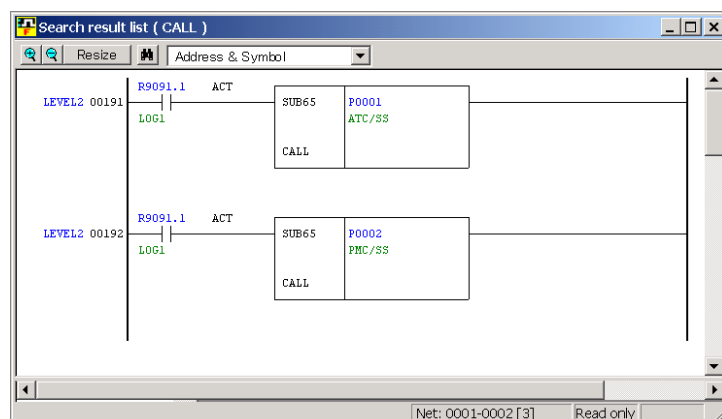

Fig. 3.5.17(e)

5. Execute search operation.

If **Search result list display** is checked, click the <Exec> button. In other cases, click the <Next search> button.

6. Clear search condition settings.

Click the [Clear] button. The setting of each item is initialized.

3.5.17.1 Context menu

Search is possible with the easy operation by right-click operation of the mouse. The context menu is displayed by the right-click after you move cursor to the address or the functional instruction to search. You can search by displayed "Find" menu.

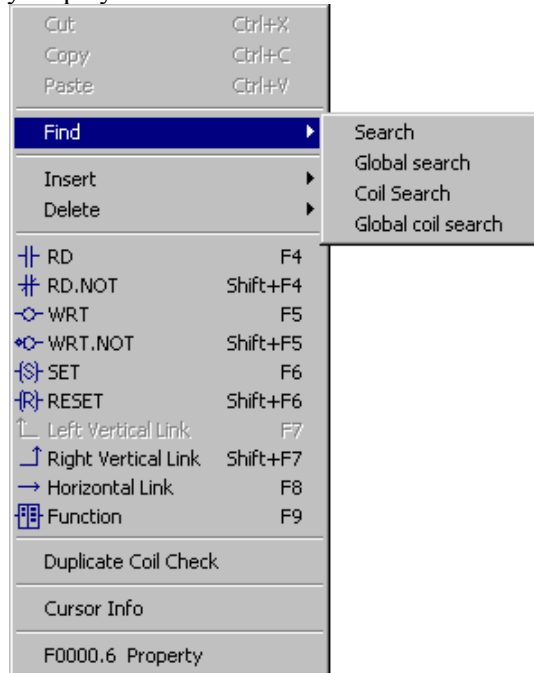

Fig. 3.5.17.1 (a)

Search	In the open ladder source program, the relay address, the coil address, the functional instruction, and the byte address are searched.
Global search	In all ladder source program, the relay address, the coil address, the functional instruction, and the byte address are searched.
Coil Search	In the open ladder source program, the coil address is searched.
Global coil search	In all ladder source program, the coil address is searched.

NOTE

- 1 The editing screen separated into the display and the editing window is not supported.
- 2 The [Monitor] and the [Signal Trigger] of the online mode are not supported.
- 3 The step sequence programs is not supported.

3.5.17.2 Soft key

The address, the symbol and the functional instruction in ladder diagram can be searched by the soft key. Two modes of operation can be chosen by the following check of the option screen: From the [Tool] menu, choose [Options], then click [Ladder] tab.

Search using the address/symbol on cursor

Table 3.5.17.2

Setting	Shortcut key	Soft key display	Explanation
No check	[F2]	Down Coil Search	The address and the symbol of the cursor position are taken in, and the downward coil of cursor is searched.
	[F3]	Down Search	The downward contact, coil and functional instruction of cursor are searched using the conditions inputted in the search screen.
	[Shift]+[F2]	Up Coil Search	The address and the symbol of the cursor position are taken in, and the upward coil of cursor is searched.
	[Shift]+[F3]	Up Search	The upward contact, coil and functional instruction of cursor are searched using the conditions inputted in the search screen.
	[Ctrl]+[F2]	Global Search	The search range changes the global or the local.
	[Ctrl]+[F3]	Search Address	The address and the symbol of the cursor position are taken in.
Check	[F2]	Down Coil Search	The address and the symbol of the cursor position are taken in, and the downward coil of cursor is searched.
	[F3]	Down Search	The address, the symbol and the functional instruction of the cursor position are taken in, and the downward coil of cursor is searched.
	[Shift]+[F2]	Up Coil Search	The address and the symbol of the cursor position are taken in, and the upward coil of cursor is searched.
	[Shift]+[F3]	Up Search	The address, the symbol and the functional instruction of the cursor position are taken in, and the upward coil of cursor is searched.
	[Ctrl]+[F2]	Global Search	The search range changes the global or the local.

3.5.18 Collective Display

Collective display is a function with which nets extracted under multiple search conditions can be monitored (in the online mode) and displayed in one window.

3.5.18.1 Setting collective display extraction conditions

Procedure

1. Double-click the <Collective Display> item on the [Program List] screen. The [Collective Display] screen appears. For buttons and input items, see the next page and later.

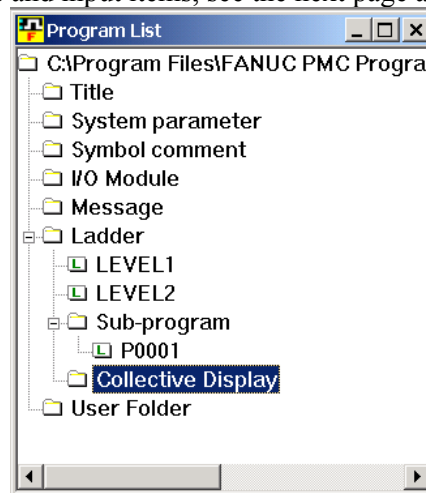

Fig. 3.5.18.1(a)

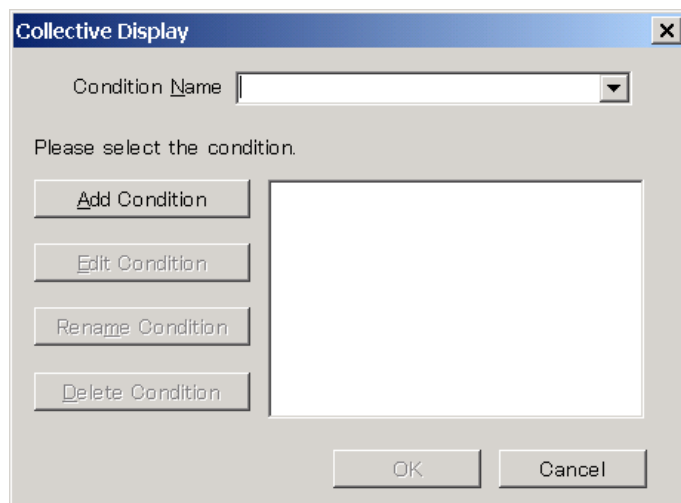

Fig. 3.5.18.1(b)

2. Click the <Add Condition> button. The [Search] screen appears.

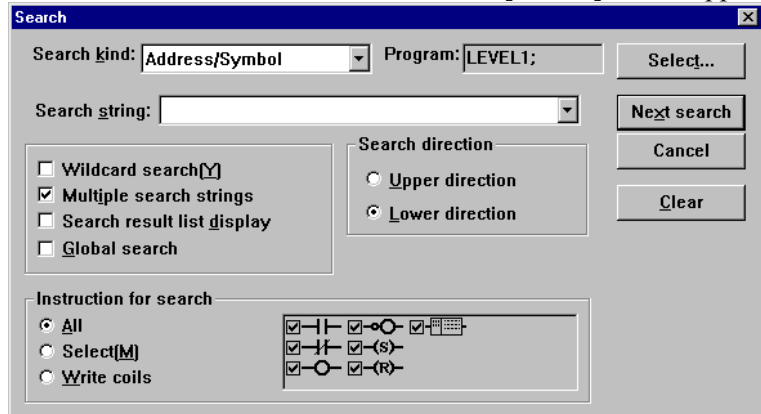

Fig. 3.5.18.1(c)

- 2-1 After setting search conditions, click the <OK> button. For each setting item, see Subsection 3.5.13, "Search."

3. The [Setting of search condition-name] screen appears.

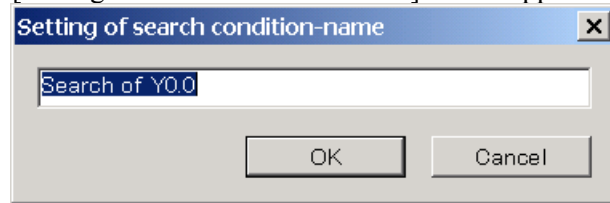

Fig. 3.5.18.1(d)

- 3-1 A character string that consists of the words "Search of" added to the start of a character string set in Search string on the [Search] screen is displayed. (Example: Search of Y0.0) A set character string can be modified. A set character string is displayed as a search condition name in the search condition list on the [Search Monitor] screen.
- 3-2 After setting a desired character string, click the <OK> button.

4. The [Collective Display] screen updated appears.

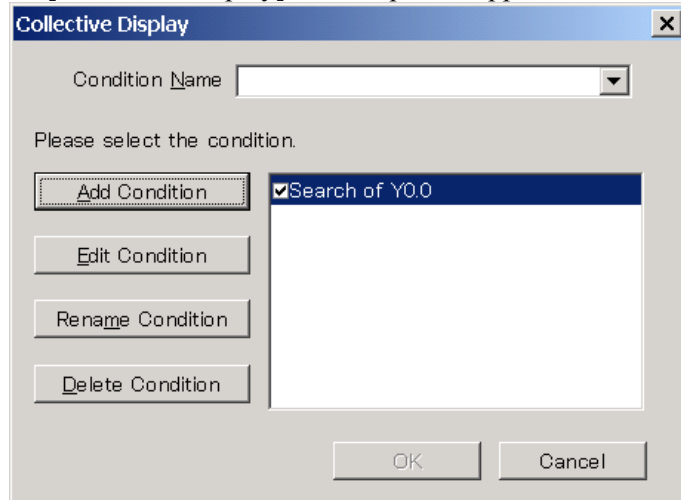

Fig. 3.5.18.1(e)

5. Repeat steps 2 through 4 to add search conditions.

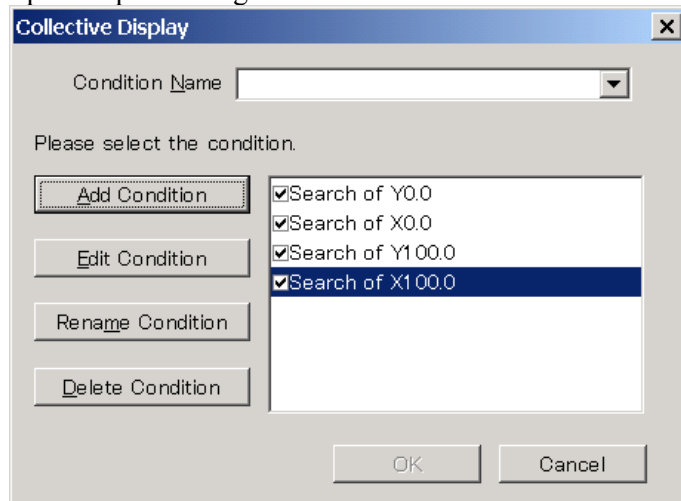

Fig. 3.5.18.1(f)

5-1 **<Edit Condition> button**

This button is used to edit the search condition where the cursor is placed.

5-2 **<Rename Condition> button**

This button is used to rename the search condition where the cursor is placed.

5-3 **<Deletion Condition> button**

This button is used to delete the search condition where the cursor is placed.

6. Check the check boxes of search conditions to be enabled, then set a desired collective display condition name in Condition Name.

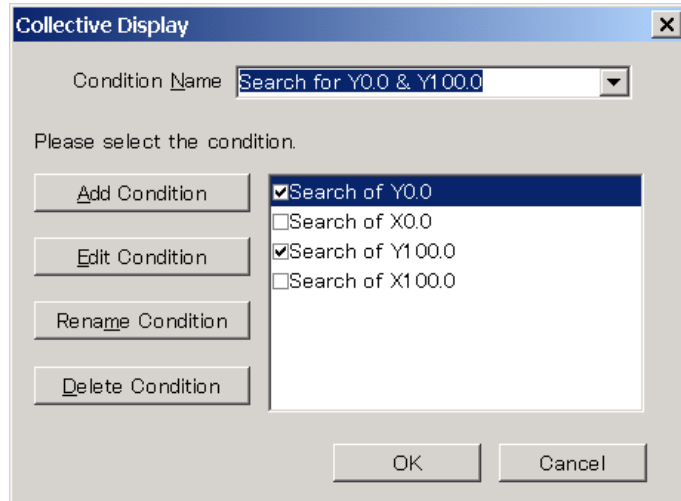

Fig. 3.5.18.1(g)

- 6-1 Click the <OK> button.

Extracted nets are collectively displayed on the screen.

The same information can also be monitored in the online mode.

An extraction condition is added to the <Collective Display> item on the [Program List] screen.

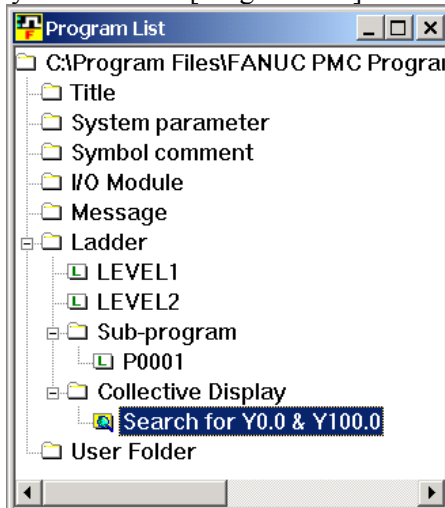

Fig. 3.5.18.1(h)

3.5.18.2 Executing collective display

Procedure

- 1 On the [Program List] screen, move the mouse pointer to the extraction condition used for collective display execution, then click the right mouse button.

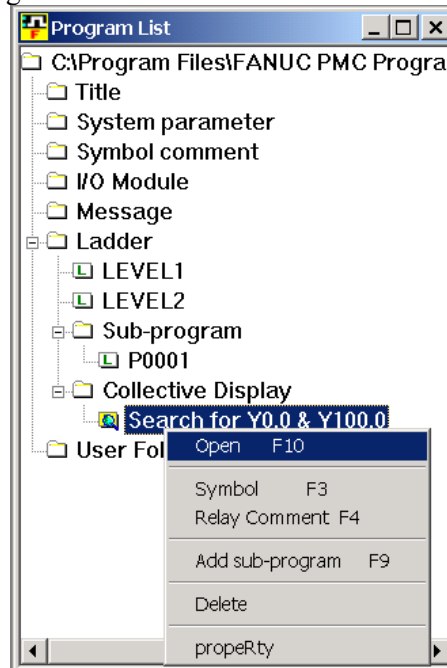

Fig. 3.5.18.2(a)

- 2 Choose [Open]. Then, the extracted nets are collectively displayed on the screen. The same information can also be monitored in the online mode.

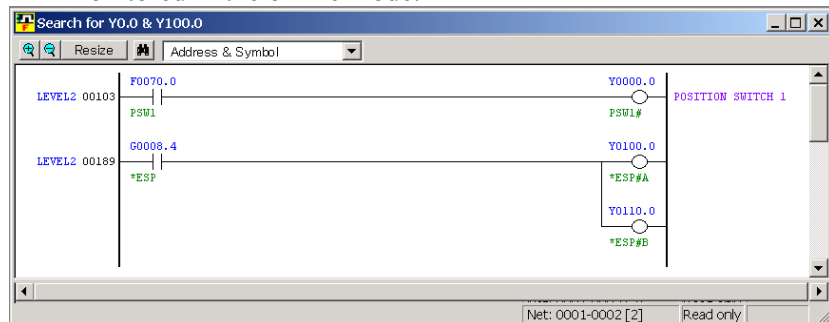

Fig. 3.5.18.2(b)

3.5.18.3 Modifying collective display extraction conditions

Procedure

1. On the [Program List] screen, move the mouse pointer to an extraction condition to be modified, then click the right mouse button.

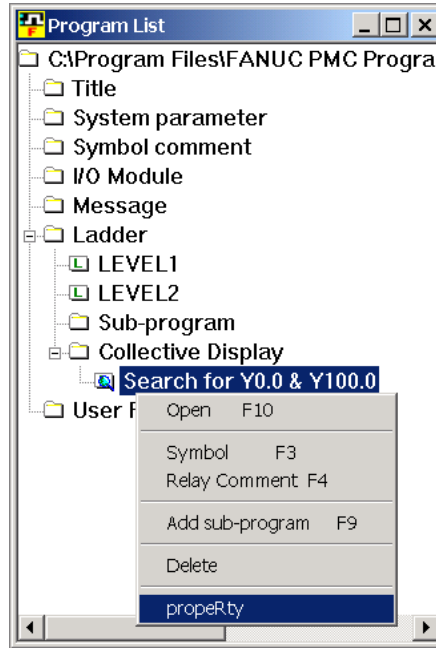

Fig. 3.5.18.3

2. Choose [propeRty]. Then, the [Collective Display] screen appears.
For extraction condition setting, see Subsection 3.5.18.1, "Setting collective display extraction conditions."

3.5.18.4 Deleting collective display extraction conditions

Procedure

1. On the [Program List] screen, move the mouse pointer to an extraction condition to be deleted, then click the right mouse button.

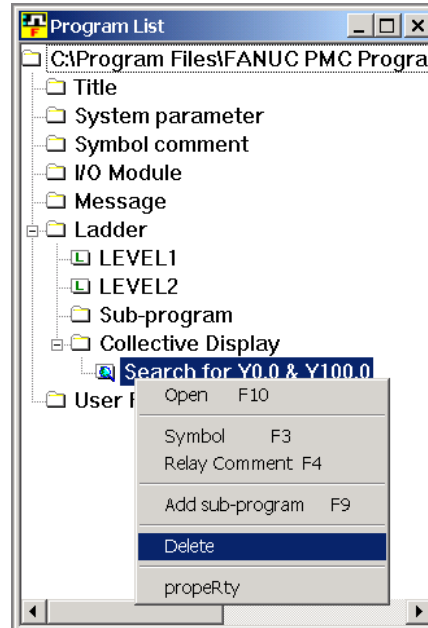

Fig. 3.5.18.4(a)

2. Choose [Delete]. Then, a message for checking whether the selected condition may be deleted appears. Click the <Yes> button to execute deletion. Click the <No> button to cancel deletion.

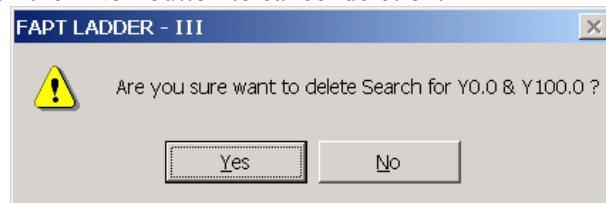

Fig. 3.5.18.4(b)

3.5.19 Setting Ladder Display

You can do the setting relevant to display and operation of the ladder diagram.

- The number of contacts and coil per row can be specified.
- The address, symbol, and comment of the basic instruction pointed with the mouse can be displayed.
- The grid lines can be displayed on the ladder diagram.
- The ladder diagram editing and display can be edited in one display window.
- Multiple Ladder windows can be displayed at the same time.
- The undo number operated in the ladder diagram edit can be specified.

Procedure

1. From the [Tool] menu, choose [Options], then click [Ladder] tab.

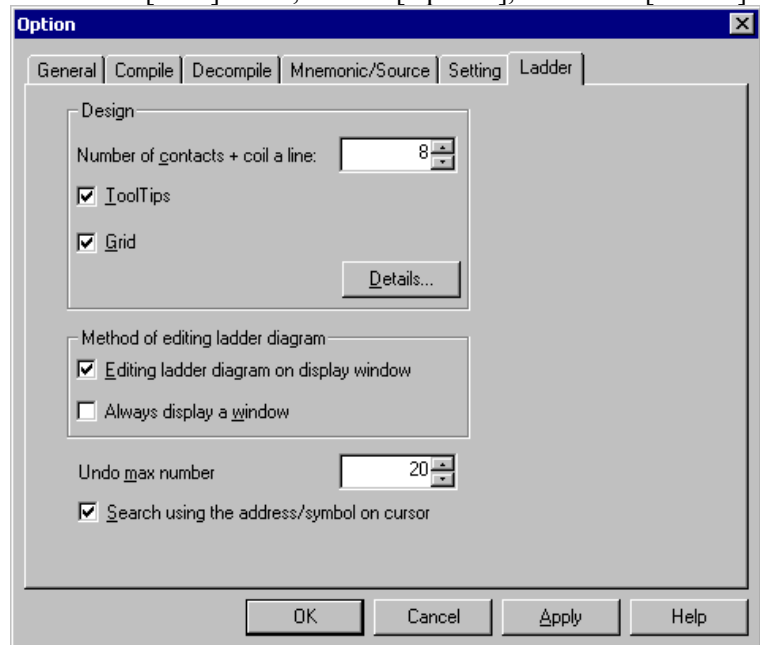

Fig. 3.5.19(a) The comment is 1 set.

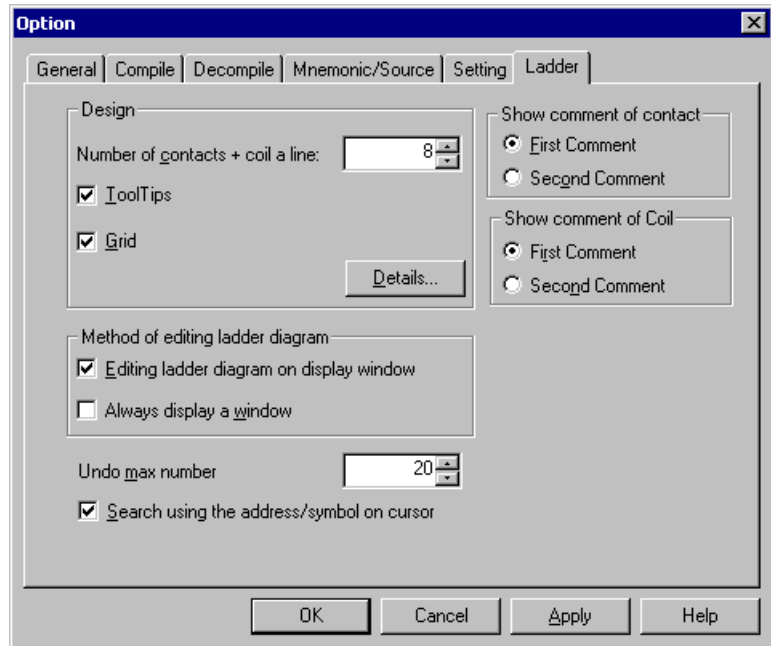

Fig. 3.5.19(b) The comment is 2 sets.

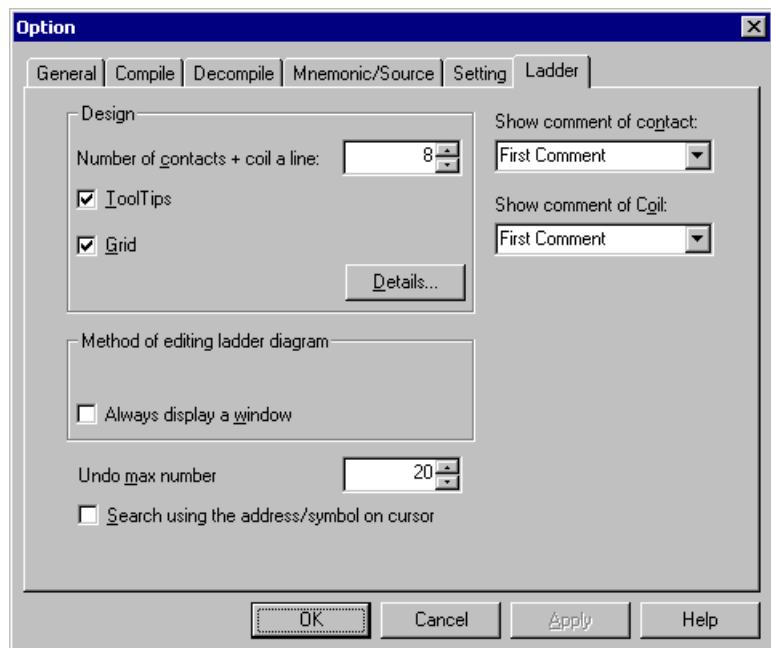

Fig. 3.5.19(c) The comment is 4 sets.

- 1-1 Number of contacts + coil a line
Set the desired number of contacts and coils per row. (A value from 8 to 20 (columns) can be set.)

NOTE

- 1 If the number of contacts and coils per row is changed, a ladder diagram in the edit window and clipboard is deleted, and reediting is disabled.
- 2 A net that has more relays or coils than the set number of contacts and coils is displayed as a continuation net as conventionally done.

1-2 **ToolTips**

When the pointer is positioned to a basic instruction in a ladder diagram, the information such as the address, the symbol and the comment is displayed. Tool tip is displayed when checked.

1-3 **Grid**

Specifies that grid lines are displayed on the ladder diagram. It is displayed when checked.

1-4 **Editing ladder diagram on display window**

Specifies that the ladder diagram is edited in the display window. The display and editing of a ladder diagram are possible in one window when checking.

1-5 **Always display a window**

Specifies that the ladder diagram editing window is always displayed. Multiple Ladder windows can be displayed at the same time when checked.

1-6 **Undo max number**

The operation of you in the ladder editing screen can be restored. The maximum number of the operations (Ctrl+Z) to restore is specified.

1-7 **Search using the address/symbol on cursor**

You can specify the way of the search by the soft key, and the search by the context menu in the ladder edit display. When there is no check of this item, you can search by F3 key in the online monitor. The search condition is set up in the search screen.

1-8 **Show comment of contact**

Select the comment which you want to display as the comment of contact in ladder edit display. When the comment is 4 sets, the comment of status bar can be specified by this item.

1-9 **Show comment of Coil**

Select the comment which you want to display as the comment of coil in ladder edit display.

2. Click the <Details...> button. A dialog box appears. In this dialog box, specify the character font, colors, and connection line thickness displayed in a ladder diagram.

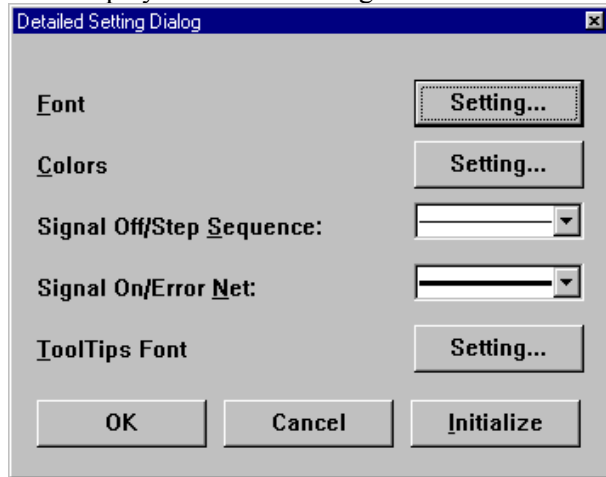

Fig. 3.5.19(d)

2-1 **Font**

Click the <Setting...> button. A dialog box appears. In this dialog box, specify the font name, style, and size of characters displayed in a ladder diagram.

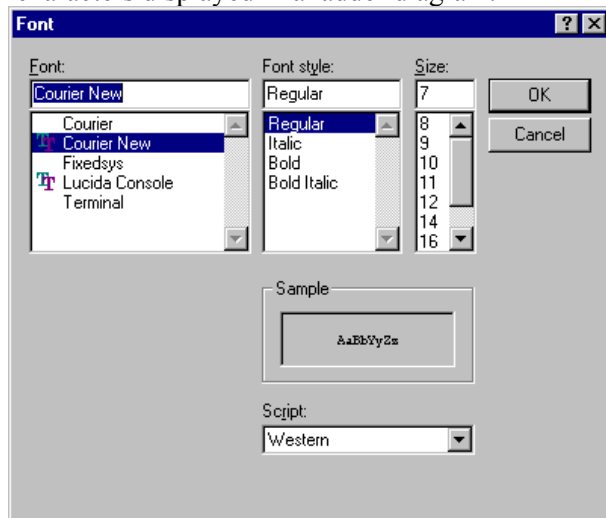

Fig. 3.5.19(e)

2-2 **Colors**

Click the <Setting...> button. A dialog appears. In this dialog box, specify the colors of items displayed in a ladder diagram.

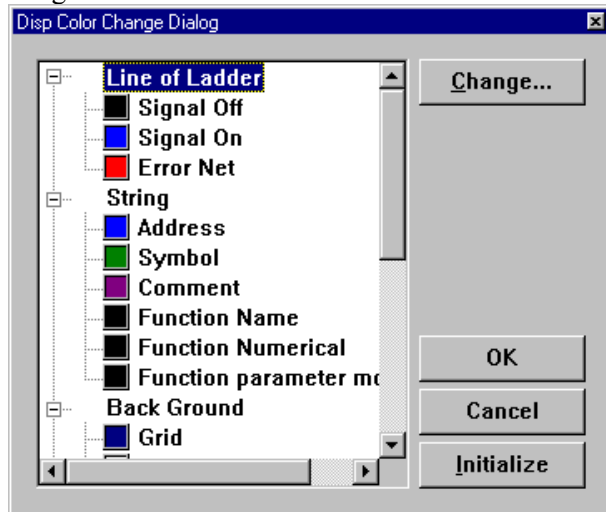

Fig. 3.5.19(f)

2-3 **Signal Off/Step Sequence**

Specifies the thickness of connection lines in the signal off state or in step sequence.

2-4 **Signal On/Error Net**

Specifies the thickness of connection lines in the signal on state or in an erroneous net.

2-5 **ToolTips Font**

Click the <Setting...> button. A dialog appears. In this dialog box, specify the font name, style, size, and color of characters for tool tip display.

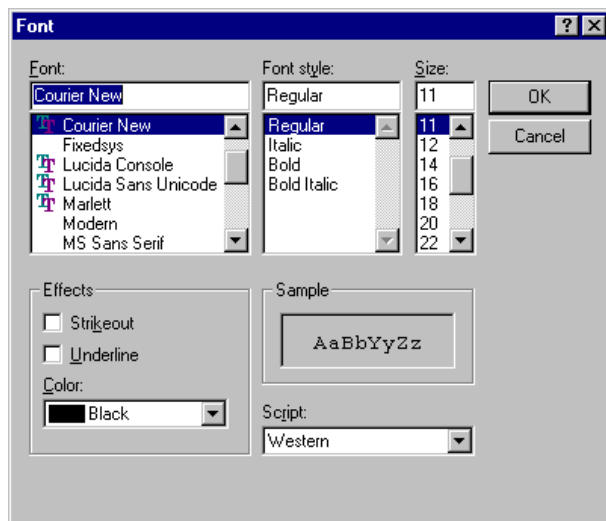

Fig. 3.5.19(g)

3.5.20 Changing Signal Addresses and Function Instruction Parameters in the Display Window

This subsection describes how to change signals addresses and function instruction parameters in the display window.

Procedure

1. Position the cursor to the signal address or function instruction parameter you want to change.
2. Press and hold down the [Shift] key and press the [Enter] key, and the address or parameter will enter the change-enabled state. (You can also key in directly after positioning the cursor.)

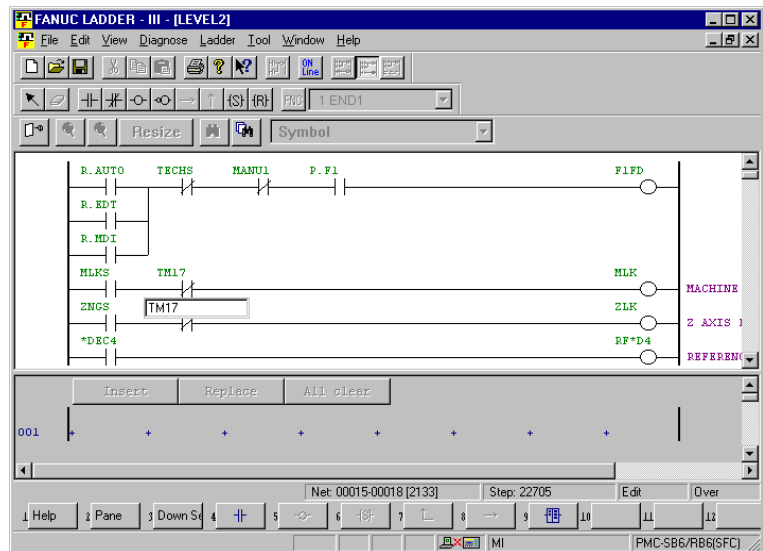

Fig. 3.5.20

3. Change the signal address or function instruction parameter, and press the [Enter] key.

NOTE

- 1 You can also enter a symbol as a signal address.
- 2 You cannot change function instruction numbers or the first parameters of the function instructions ADDB, AND, COMPB, DIVB, EOR, MULB, OR, and SUBB.

3.5.21 Changing Contacts and Coils in the Display Window

This subsection describes how to change contacts and coils in the display window.

Procedure

1. Position the cursor to the contact or coil you want to change.

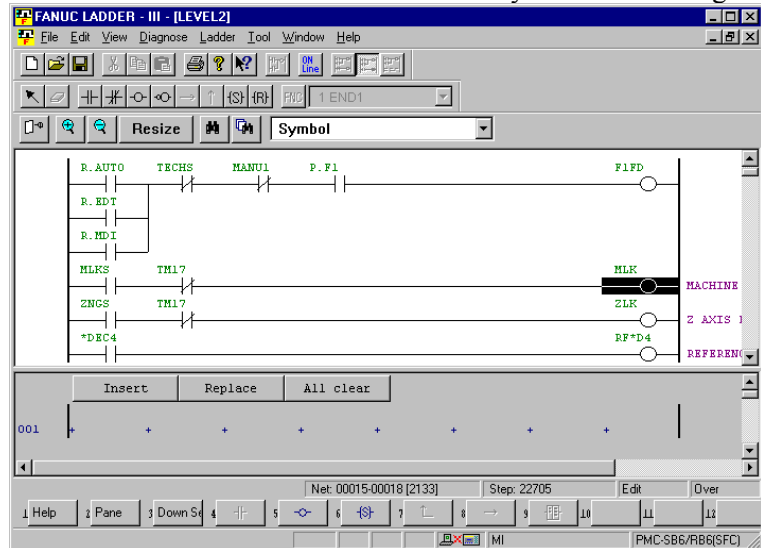

Fig. 3.5.21 (a)

2. Click the soft key that corresponds to the contact or coil you want to change.
(You can also change the contact or coil to the one selected with the edit toolbar.)

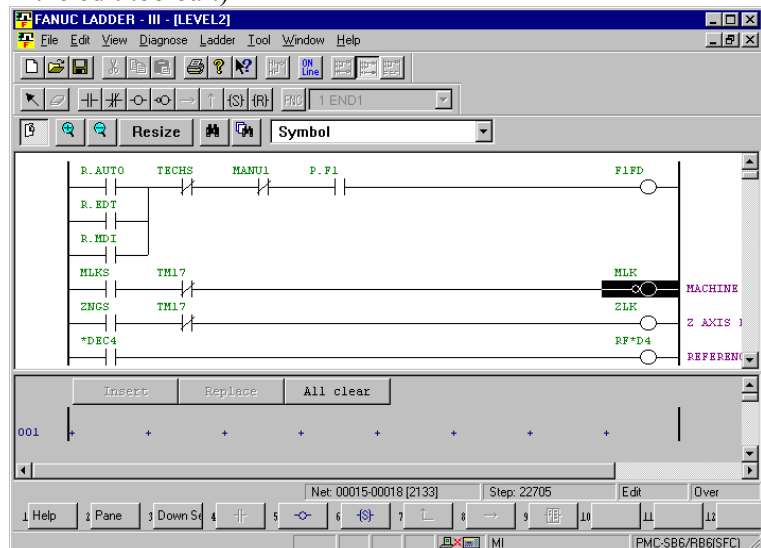

Fig. 3.5.21 (b)

NOTE
You cannot insert or delete contacts/coils. Nor can you enter horizontal/vertical lines.

3.5.22 Checking the Number of Program Steps

This subsection describes how to check the total number of steps in a ladder program and the number of steps in each subprogram.

Procedure

1. On the [Program List] screen, position the pointer to a program for which you want to check the number of program steps and click the right mouse button. Then, click [Properties].

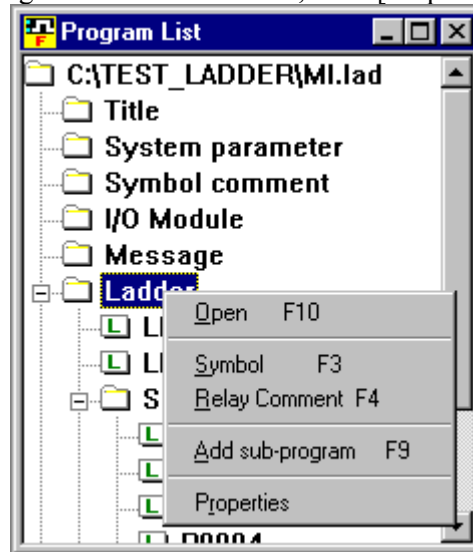

Fig. 3.5.22 (a)

1-1 Ladder

The total number of steps in the program is displayed.



Fig. 3.5.22 (b)

1-2 **LEVEL1**

Displays the number of steps in each of LEVEL1 to LEVEL3.

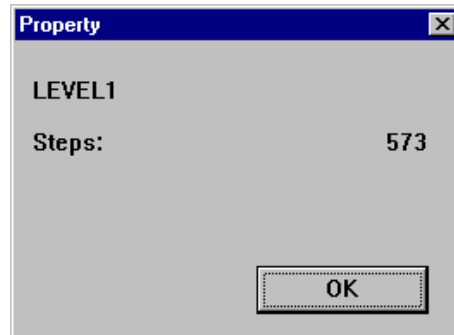

Fig. 3.5.22 (c)

1-3 **Sub-program**

Displays the number of steps in each subprogram.

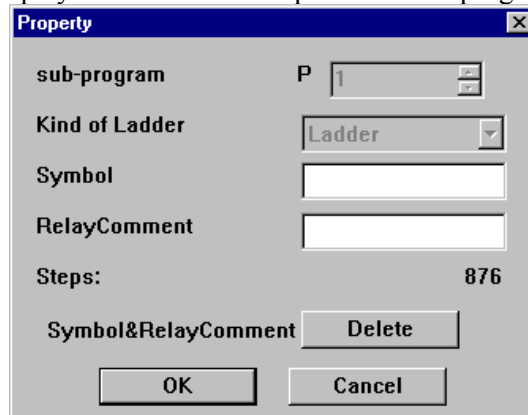

Fig. 3.5.22 (d)

NOTE

- 1 If a step sequence program is contained, the total number of program steps is not displayed.
- 2 The number of steps in a step sequence program is not displayed.
- 3 In online mode, the number of program steps is not displayed.

3.5.23 Replace

This subsection describes the ladder program replace function.

Procedure

1. From the [Edit] menu, choose [Replace].
The [Replace] screen appears.

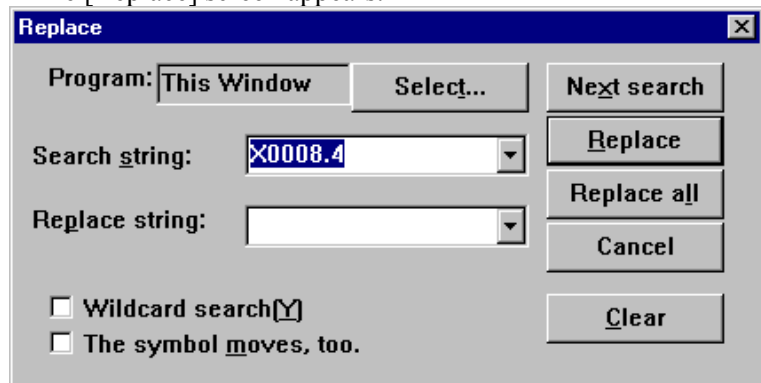

Fig. 3.5.23 (a)

1-1 Program

Click the <Select...> button to open the [Program select dialog] screen. Then, select the program in which you want to search for a string.

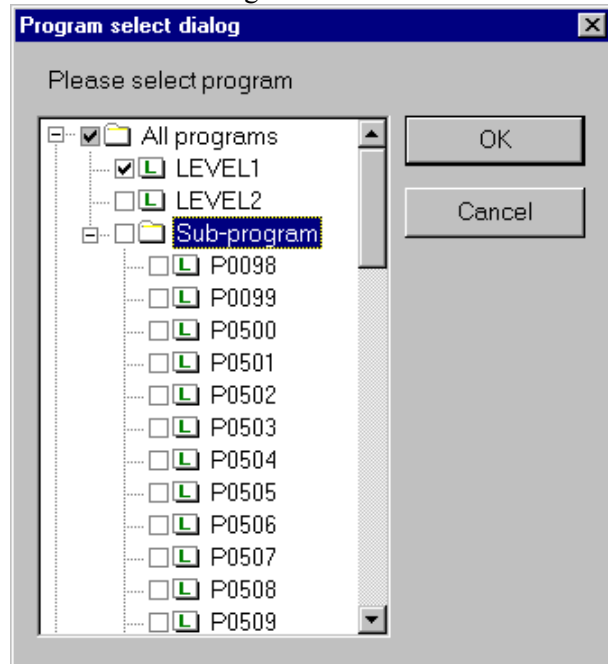

Fig. 3.5.23 (b)

1-2 Search string

Enter a character string you want to search for.

In a character string to be searched for, two types of wildcards can be used: a question mark (?) and an asterisk (*).

1-3 **Replace string**

Enter a character string you want to replace with.

In a character string to be replaced with, two types of wildcards can be used: a question mark (?) and an asterisk (*).

NOTE

- 1 A wildcard can substitute for one or multiple characters.
- 2 A question mark (?) represents one character. This wildcard can be used more than once to represent characters.
- 3 An asterisk (*) represents zero or more characters.

1-4 **Wildcard search**

Check this check box if a character string to be replaced with includes wildcards.

2. Execute replace operation.

2-1 <Next search> button

Searches for the target character string.

2-2 <Replace> button

Replaces [Search string] with [Replace string].

2-3 <Replace all> button

Replaces all occurrences of [Search string] with [Replace string].

2-4 <Cancel> button

Cancels replace operation and closes the [Replace] dialog box.

2-5 <Clear> button

Places all items in their initial state.

3. Wild card

3-1 Asterisk (*)

The following types of wildcard replacement using asterisks are available:

Character string to be searched for	Character string to be replaced with				
	Y200	Y*	Y200.1	Y*.1	Y200.*
X100	A	B	B	B	B
X*	A	B	B	B	B
X100.0	B	B	A	B	B
X*.0	B	B	A	C	A
X100.*	B	B	A	A	A

A : Can be replaced.

B : Cannot be replaced.

C : Can be replaced only when the signal names are the same.

(Example) X*.0 → X*.1

The following types of wildcard specifications are not available:

X1*	X1*1	X*1	X*1*
X1*.0	X1*1.0	X*1.0	X*1*.0
X1*.*	X1*1.*	X*1.*	X*1*.*
X*.*	*.*		

3-2 Question (?)

The following types of wildcard replacement using question marks are available:

Can be replaced.	Cannot be replaced.
X0??0 → Y0??0	X0??0 → Y0?00
	X0??0 → Y0?0?
	X0??0 → Y0???
	X0??0 → Y0??0.0
X0??0.0 → Y0??0.0	X0??0.0 → Y0??0.?
	X0??0.0 → Y0???

NOTE

- 1 Address P can be replaced with another character string only in the CALL and CALLU instructions.
- 2 No wildcards can be used for replacing an address using a symbol.
- 3 No wildcards can be used in a signal name.

3.5.24 Changing Ladder Programs on the Display Window

This subsection describes how to modify a ladder program only on the display window without using the edit window.

3.5.24.1 Changing the ladder editing mode

From the [Tool] menu, choose [Option].
In the [Option] dialog box, click the [Ladder] tab.

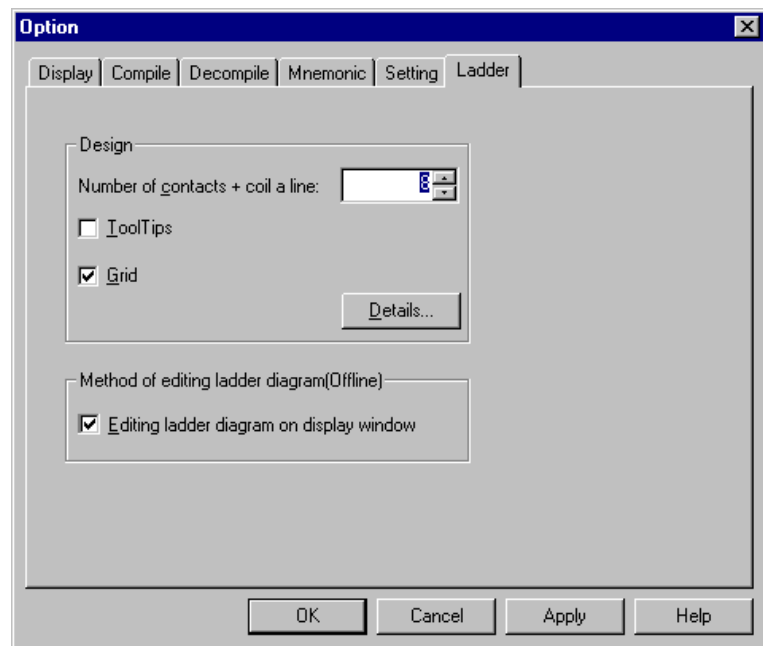

Fig. 3.5.24.1

Check [Editing ladder diagram on display window] under [Method of editing ladder diagram (Offline)].

3.5.24.2 Inserting an edit line

Procedure

Move the cursor to a position where you want to enter an edit line, using direction keys. Click the right mouse button and select the [Insert] menu.

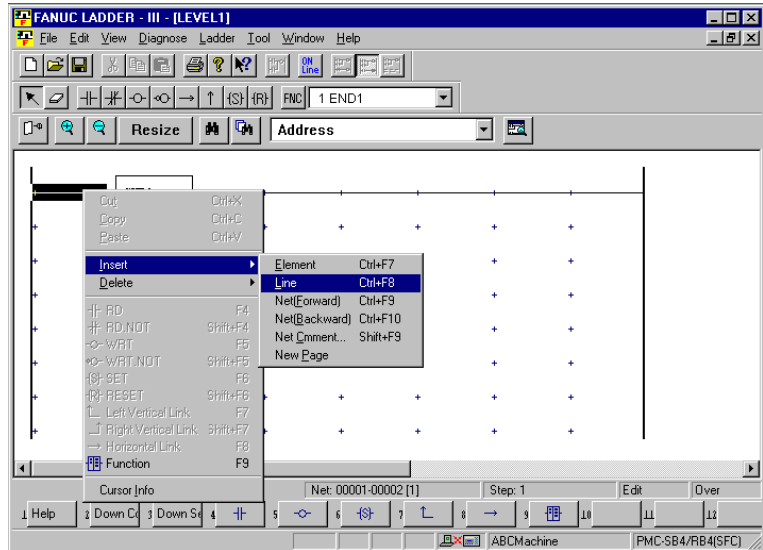

Fig. 3.5.24.2

3.5.24.3 Entering basic instructions

1. This subsection describes how to enter basic instructions (relays and coils).

Procedure

- 1-1 Position the cursor to the point where you want to enter a basic instruction, using the cursor control keys. (Alternatively, click the point.)

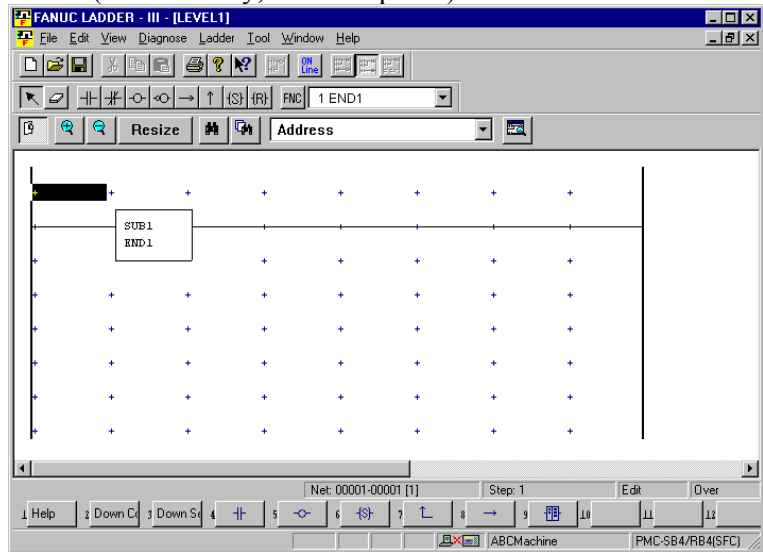

Fig. 3.5.24.3(a)

- 1-2 Press the key that corresponds to the basic instruction you want to enter.

Table 3.5.24.3

Key	Basic instruction
[F4]	
[Shift] + [F4]	
[F5]	
[Shift] + [F5]	
[F6]	
[Shift] + [F6]	

3. CREATING AND EDITING SEQUENCE PROGRAMS

- 1-3 Position the cursor to the basic instruction you entered, using the cursor control keys, and then press the [Enter] key. (Alternatively, double-click the basic instruction.)

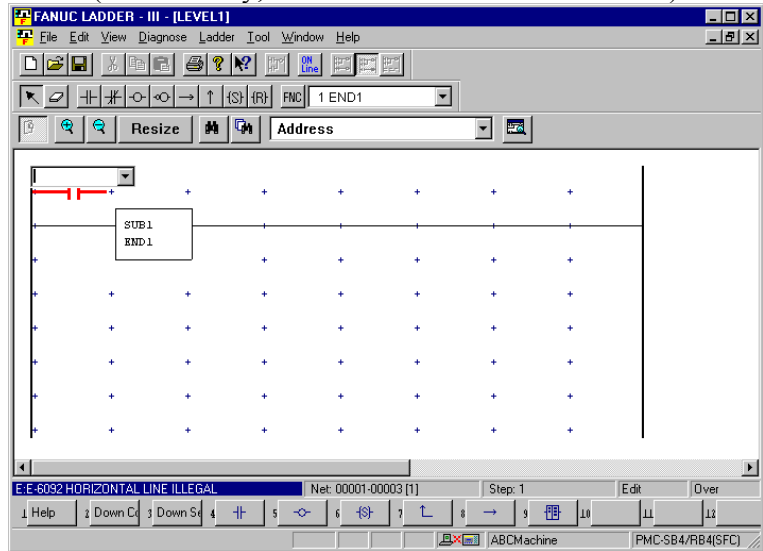

Fig. 3.5.24.3(b)

- 1-4 Enter an address or symbol, and then press the [Enter] key.

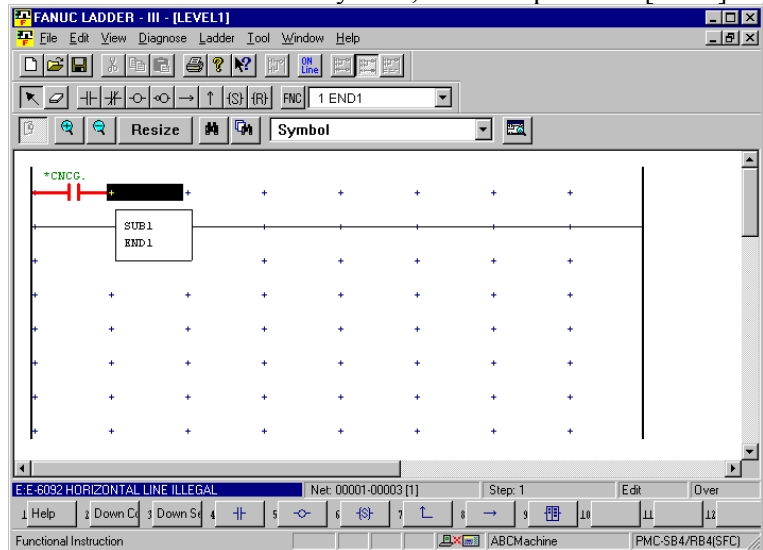

Fig. 3.5.24.3(c)

2. After entering an address or symbol, you can enter basic instructions using function keys.

Procedure

- 2-1 Position the cursor to the point where you want to enter a basic instruction, using the cursor control keys. (Alternatively, click the point.)

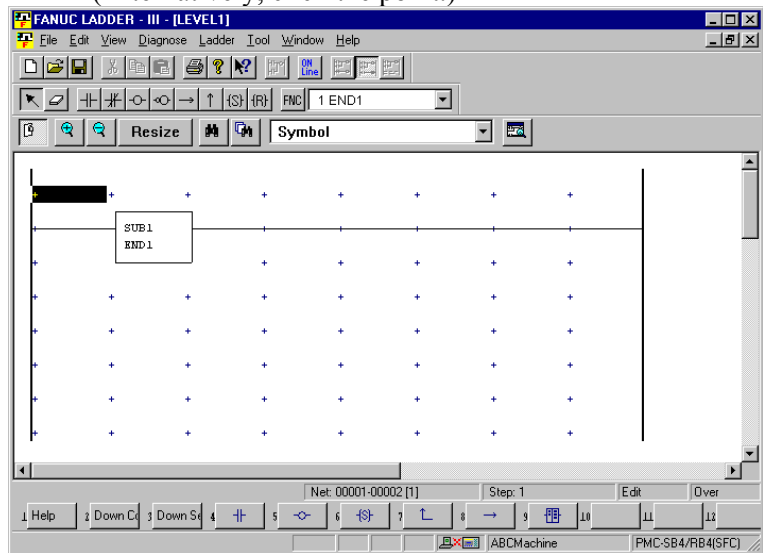

Fig. 3.5.24.3(d)

- 2-2 Enter an address or symbol.

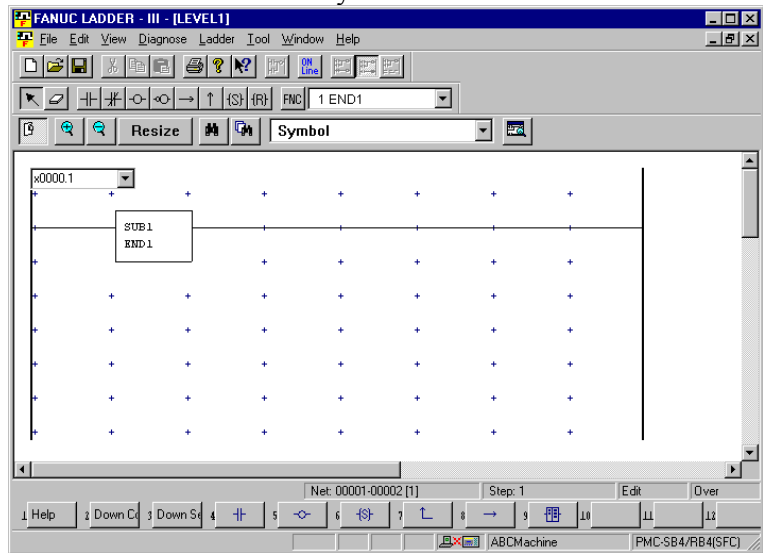

Fig. 3.5.24.3(e)

3. CREATING AND EDITING SEQUENCE PROGRAMS

2-3 Press the key that corresponds to the basic instruction you want to enter. (See Table 3.5.24.3.)

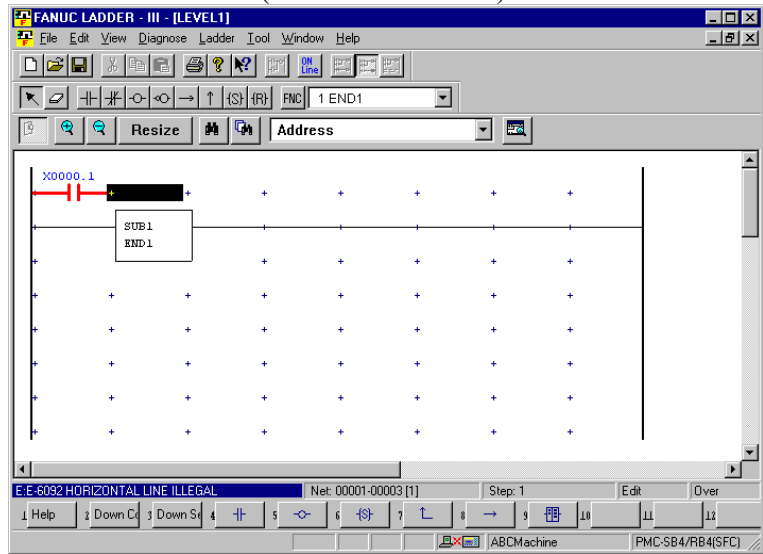

Fig. 3.5.24.3(f)

3.5.24.4 Entering function instructions

1. This subsection describes how to enter function.

Procedure

- 1-1 Position the cursor to the point where you want to enter a function instruction, using the cursor control keys. (Alternatively, click the point.)

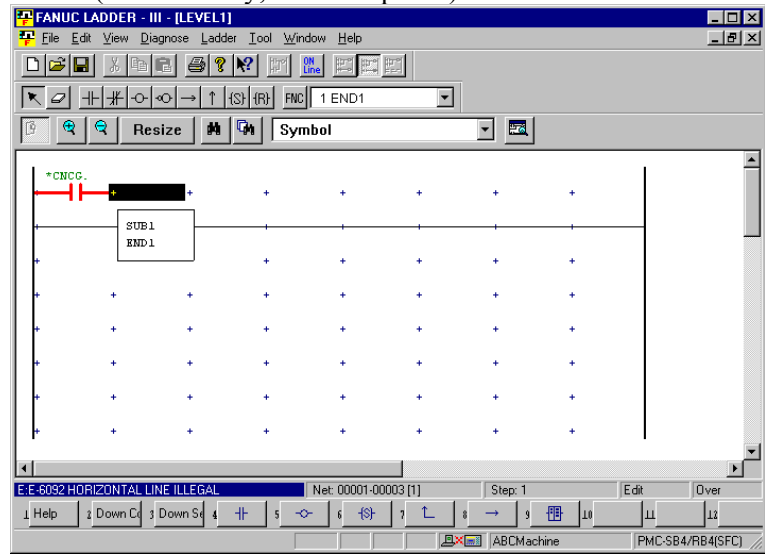

Fig. 3.5.24.4(a)

- 1-2 Press the [F9] key to display the [Select function] dialog box.

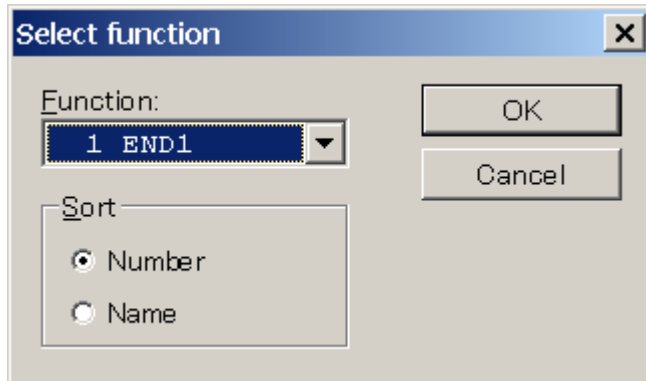

Fig. 3.5.24.4(b)

3. CREATING AND EDITING SEQUENCE PROGRAMS

1-3 Select the function instruction you want to enter, and then press the <OK> button.

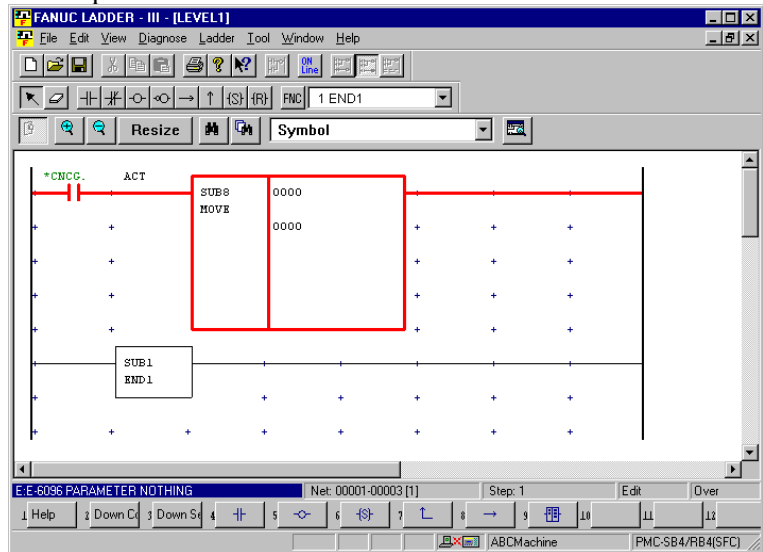

Fig. 3.5.24.4(c)

1-4 Enter the parameters for the instruction you entered.

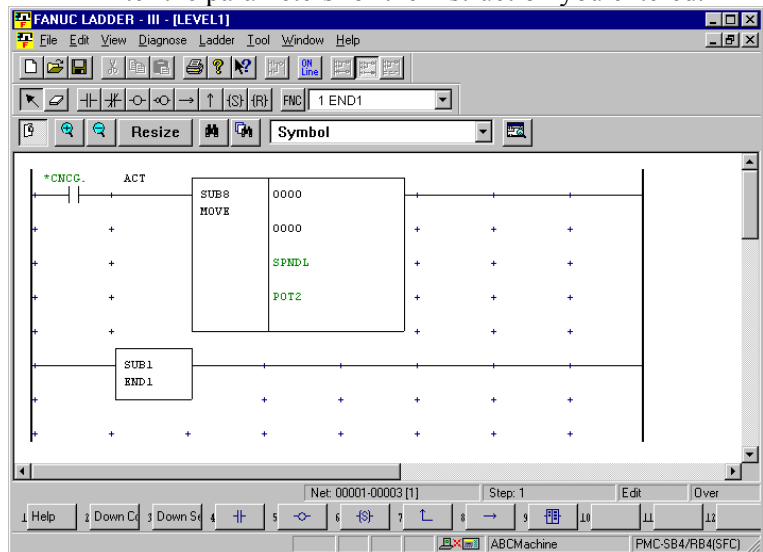

Fig. 3.5.24.4(d)

- 2 After entering a function instruction number or name, you can enter a function instruction using the [F9] key.

Procedure

- 2-1 Position the cursor to the point where you want to enter a function instruction, using the cursor control keys. (Alternatively, click the point.)

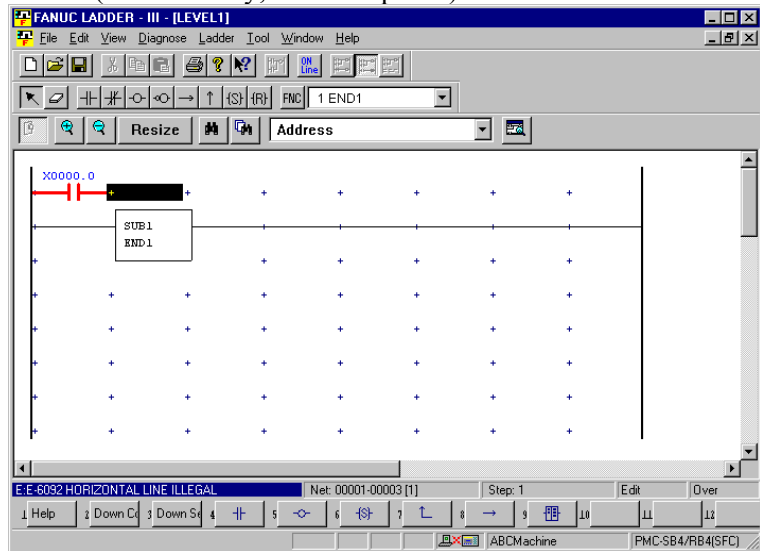

Fig. 3.5.24.4(e)

- 2-2 Enter a function instruction number or name.

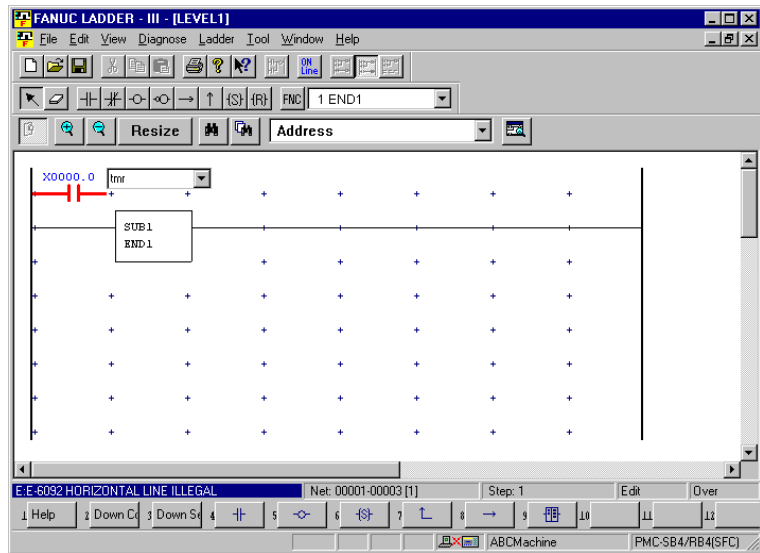

Fig. 3.5.24.4(f)

2-3 Press the [F9] key.

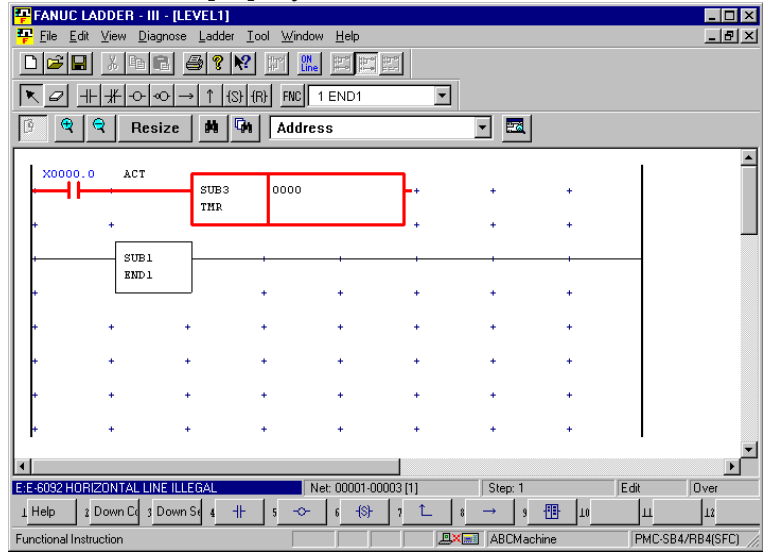

Fig. 3.5.24.4(g)

3.5.24.5 Entering horizontal lines

This subsection describes how to enter horizontal lines.

Procedure

1. Position the cursor to the point where you want to enter a horizontal line. (Alternatively, click the point.)

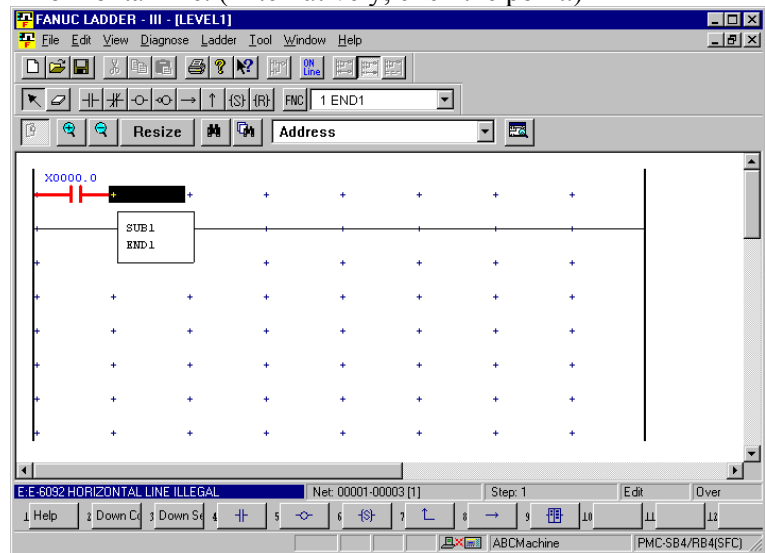

Fig. 3.5.24.5(a)

2. Press the [F8] key.

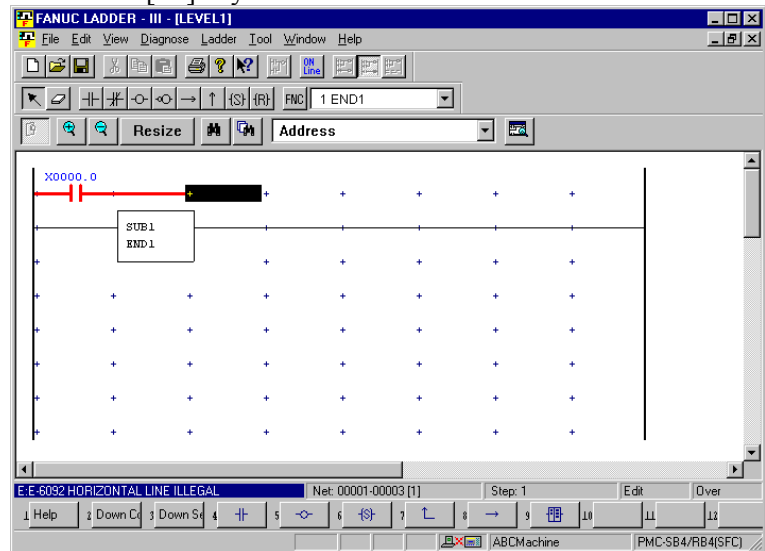

Fig. 3.5.24.5(b)

3.5.24.6 Entering and deleting vertical lines

This subsection describes how to enter and delete vertical lines.

Procedure

1. Position the cursor to the point where you want to enter a vertical line, using the cursor control keys. (Alternatively, click the point.)

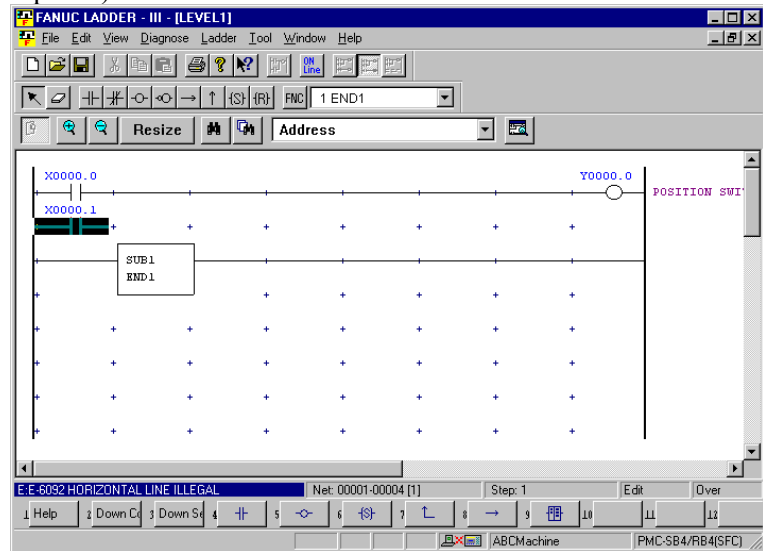

Fig. 3.5.24.6(a)

2. Press the [F7] key to enter a vertical line at the left of the cursor position. Press [Shift]+[F7] to enter a vertical line at the right of the cursor position. To delete a vertical line, press the same soft key again.

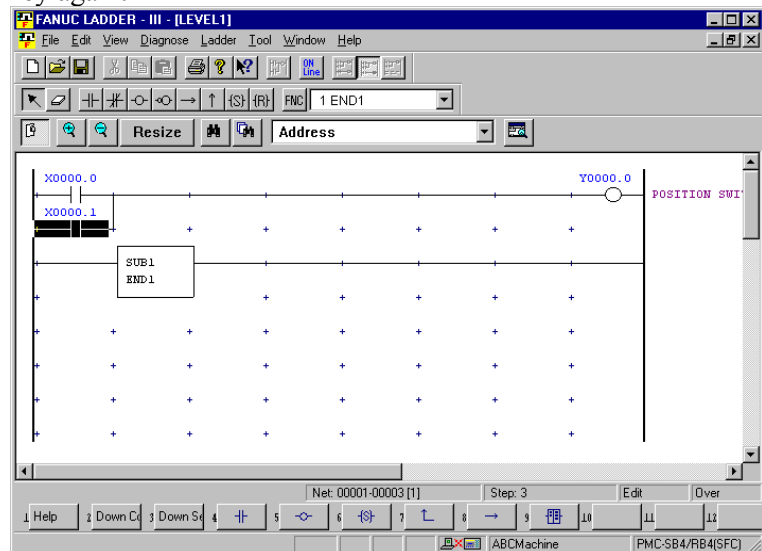

Fig. 3.5.24.6(b)

3.5.25 Deleting Symbol or Comment Data

This subsection describes how to delete symbol or comment data in ladder diagram editing.

Procedure

1. Move the cursor to the position of a basic instruction for which you want to delete symbol or comment data, using direction keys.
2. Click the right mouse button and choose [Property].

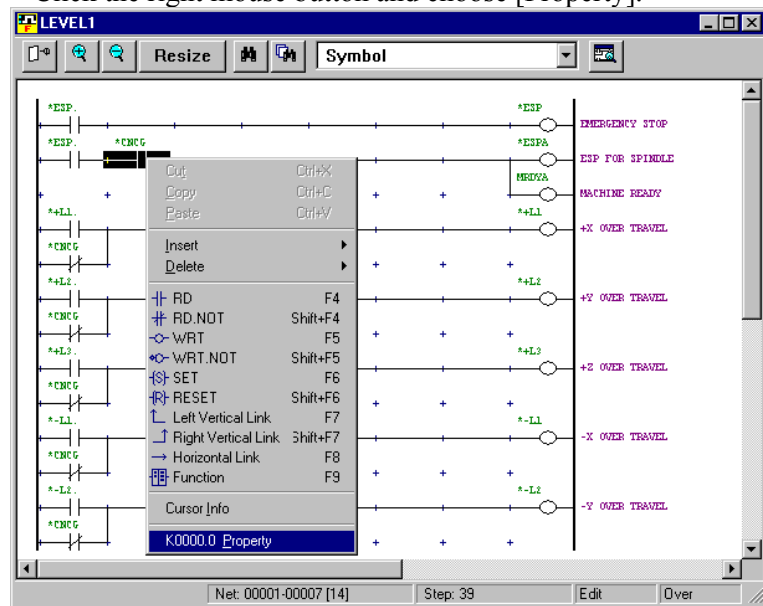

Fig. 3.5.25(a)

2. Click the <Delete> button. The symbol or comment data is deleted.

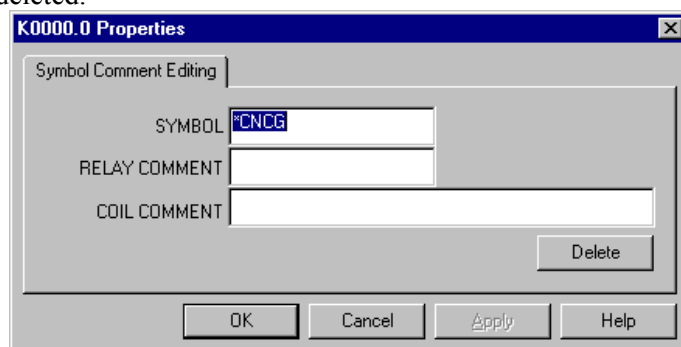

Fig. 3.5.25(b)

3.5.26 Undo / Redo

This subsection describes the operation of Undo / Redo function on the ladder edit screen.

Procedure

1. Select [Edit]-[Undo] from the menu-bar, or click the toolbar button, or push the shortcut key of [Ctrl]+[Z]. Then the previous edit operation in the ladder edit screen is canceled.
2. Select [Edit]-[Redo] from the menu-bar, or click the toolbar button, or push the shortcut key of [Ctrl]+[Y]. Then the operation canceled by Undo function is executed again.

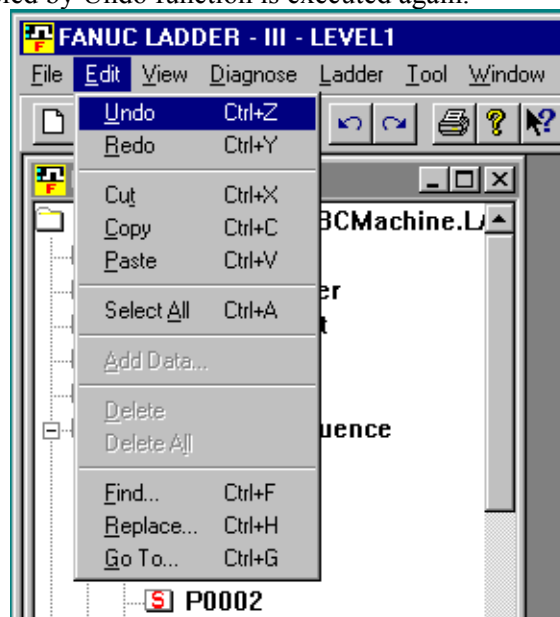

Fig. 3.5.26(a)



Fig. 3.5.26(b)

3.5.26.1 Setting the maximum number of undo operations.

Procedure

1. Select [Tool]-[Option]. Then click the [Ladder] tab.
2. Move the cursor to [Undo max number], and set the maximum number of Undo operations. (Range of setting : 0 - 50)
3. Click the <OK> button.

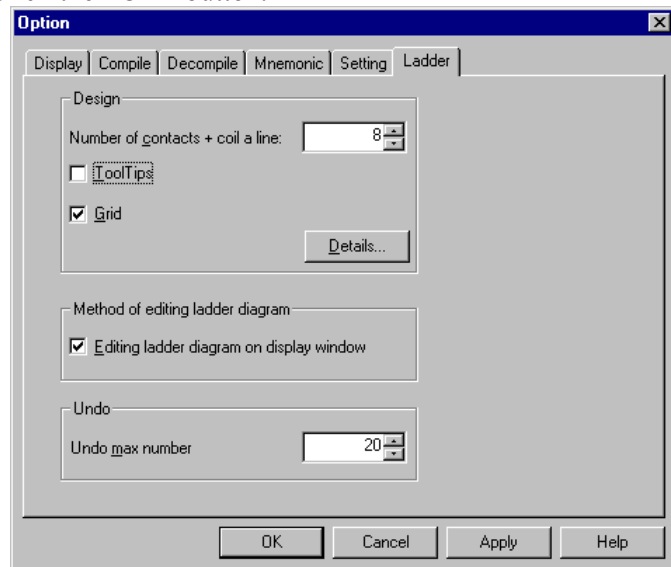

Fig. 3.5.26.1

NOTE

- 1 This function is effective to the following edit operations.
 - Ladder editing in the direct ladder edit screen (Includes "Change of PMC address by Replace function".)
 - Addition and deletion of sub-program (P1/P2...) in program list screen.
- 2 Undo log is erased by the following operation.
 - Changing the "Number of contacts + coil a line"
 - Changing the "Method of editing ladder diagram"
 - Changing the online mode
 - Executing the Decompile
 - Importing the source program
- 3 There is a case that the operation cannot be canceled correctly, when the nets which contain the error are connected.

3.5.27 Ladder Diagram is Outputted to the Text File

The ladder diagram is outputted to the text file in the form currently displayed on the Ladder edit display. The outputted text file can be opened by text editors, such as "notepad", or it can be printed. Also, it can reduce the file size. The ladder diagram of the All ladder, the Sub-program, the Search result list, the Collective display and the Duplicate Coil can be outputted.

NOTE

- 1 The editing screen separated into the display and the editing window is not supported.
- 2 If the programmer mode is offline, this function is available.
- 3 The step sequence programs is not supported.

3.5.27.1 Procedure

1. Display the subprogram you want to output or move it to the top.

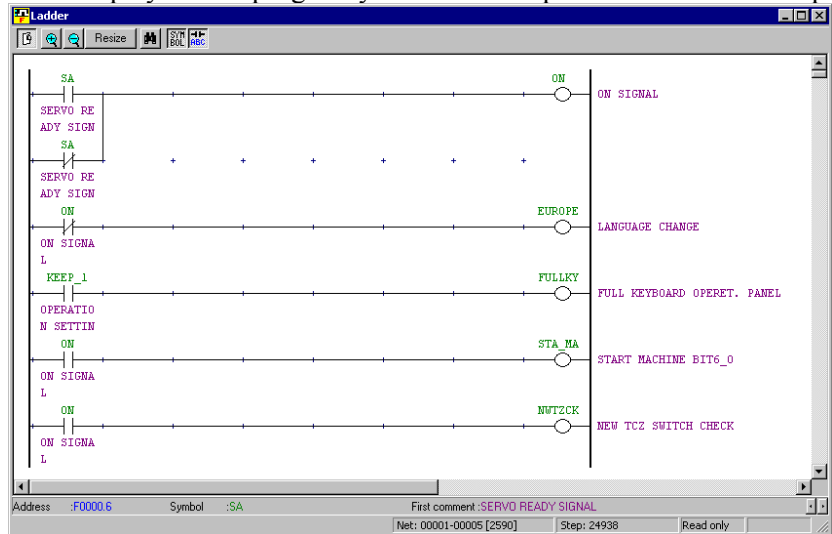

Fig. 3.5.27.1 (a)

2. [Output a text format file...] is selected from the [Tool] menu.

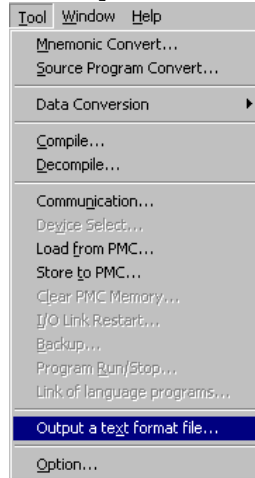

Fig. 3.5.27.1 (b)

3. Input the output file name. Push the <Save> button and the file is outputted.

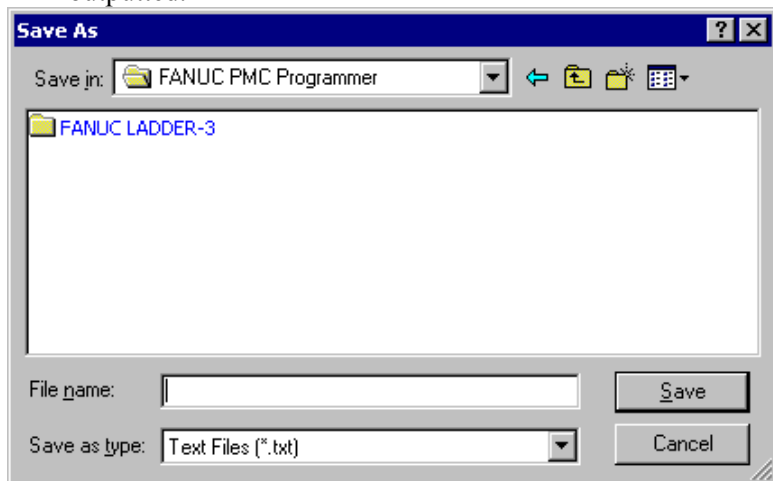

Fig. 3.5.27.1 (c)

NOTE

- 1 The menu item can not be selected if there is an error net.
- 2 It is necessary to display and select the window of the ladder.
- 3 As to the storing folder of the text file, you can choose the default of the storing folder by the **Specify the same folder as a LAD file for working directory** in the [General] tab of the option.(select the [Tool] - [Option...])

Checked.....The same folder as the LAD file.
(Initial value) It is useful when saving at the same folder as the LAD file.

Not checked...The folder stored previously.
It is useful when saving to a specified folder each time.

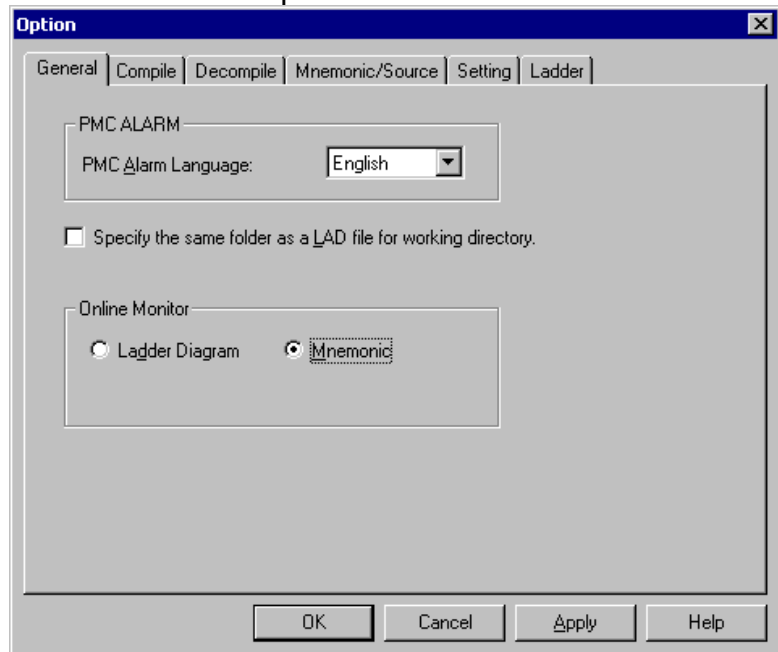

3.5.27.2 The example of an output file

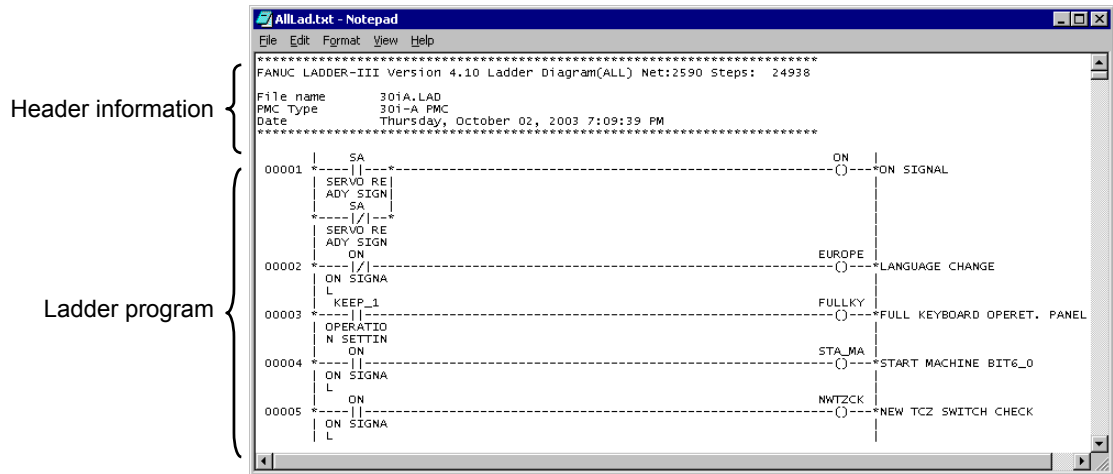

Fig. 3.5.27.2(a)

Header information

Header information changes according to the kind of outputted program.

Program	Title
All	Ladder Diagram (ALL)
LEVEL1	Ladder Diagram (LEVEL1)
Sup-program	Ladder Diagram (P0001)
Search result list	Ladder Diagram Search result list (*)
Collective Display	Ladder Diagram Collective Display (*)
Duplicate Coil	Duplicate Coil List

- In the Search result list and the Collective Display, the number of nets and the number of steps are not outputted.
- *: The Search condition and the condition name of Collective Display are displayed.

Item	Contents
File name	LAD file name
PMC Type	The model of PMC
Date	Date the file was created.

* Date is dependent on "Regional options".

3.5.27.3 Ladder diagram without the net number is output to the text file

The setting to output the ladder diagram without the net number in the text file has been added. Since the net numbers are not output, you can compare the ladder diagrams before and after the modifications using the function of a text editor.

Setting

1. Click [Option...] in [Tool] menu.
2. Click [Ladder] tab on [Option] window.
3. Check [Output the text file without the net number].

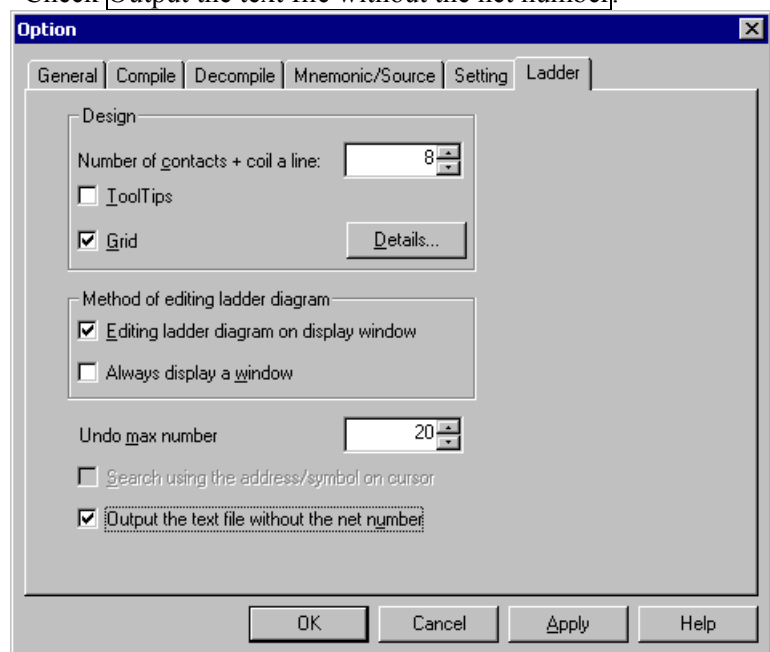

Fig. 3.5.27.3(a)

Operation

1. The Ladder program to output is displayed
2. [Output a text format file...] is selected from the [Tool] menu.
3. Input the output file name. Push the <Save> button and the file is outputted.

3.5.28 Automatic Input of Timer, Counter, Rising / Falling-Edge Numbers

This function automatically inputs the unused numbers for the parameters of functional instructions during ladder editing of offline mode and online mode. With this function, you can omit your operation to find out the unused parameter numbers.

Supported PMC models

Supported	30i/31i/32i-A Extended function 30i/31i/32i-A (*1)
------------------	---

*1: This function can be used when ladder edit has selected the interface of one pane; "Editing ladder diagram on display window". This function cannot be used when ladder edit has selected the interface of two panes; "Display Window" and "Edit Window".

Supported instructions

The 1st parameter of the following functional instructions is the target of automatic input.

SUB3(TMR)
SUB24(TMRB)
SUB77(TMRBF)
SUB5(CTR)
SUB56(CTRB)
SUB57(DIFU)
SUB58(DIFD)

Operation

1. Move cursor to the 1st parameter and push the [F6] key. The unused parameter number will be input.

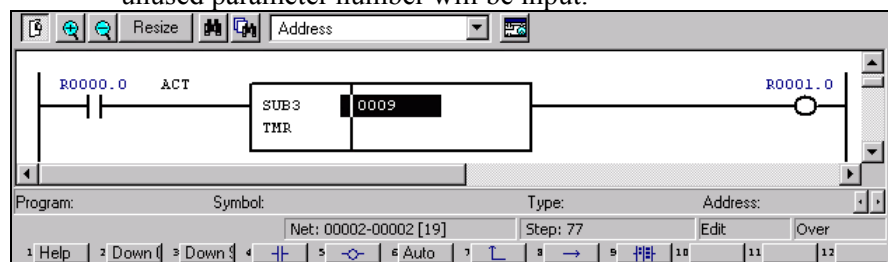

Fig. 3.5.28

 **CAUTION**

- 1 Details are different between SUB3 (TMR) and SUB5 (CTR).For details, see "Automatic input of the TMR parameter of a functional instruction" and "Automatic input of the CTR parameter of a functional instruction", described later.
- 2 If you perform this operation with a parameter number already input, an unused parameter number subsequent to that number will be set.
- 3 If you perform this operation just after you enter the parameter numbers, an unused parameter number subsequent to input number will be set. If you click "Auto" with the mouse, the same result as the item 2 is obtained.
- 4 If an attempt is made to perform this operation on a function instruction to which this operation is not applicable, the following error message will be displayed.
'Cannot perform "Auto" on the instruction.'
If no unused number for parameters is found, the following error message will be displayed.
'No unused parameter number.'
- 5 This function cannot be used when ladder edit in the interface of two panes is selected; "Display Window" and "Edit Window".

3.5.28.1 Automatic input of the TMR parameter of a functional instruction

When inputting the TMR parameter, you must consider precision. Some contents of the display differ in offline editing and online editing.

Offline editing

- (1) Range of parameter numbers subject to this automatic input
Timer numbers with their precision default setting being 8 ms (timer number 9 and subsequent numbers) are assumed to be subject to this automatic input.

Online editing

- (1) Range of parameter numbers subject to this automatic input
The timer number 9 or later is assumed to be subject to this automatic input.
- (2) Display of setting and precision of an input timer number
In online editing, the preset value and accuracy value of an input timer number are displayed in the status line in the following format.

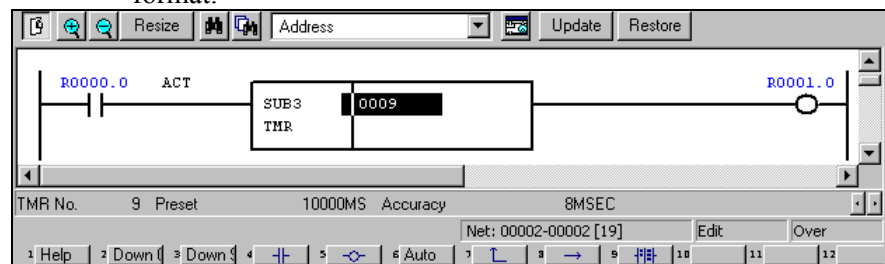

Fig. 3.5.28.1(a)

NOTE

All models are supporting the display of the TMR number, the preset value and accuracy value on the status line. If the automatic input of the TMR parameter is supported, "Auto" will be displayed on the [F6] key.

3.5.28.2 Automatic input of the CTR parameter of a functional instruction

Online editing

In online editing, the preset value and current value of an input counter number are displayed in the status line in the following format.

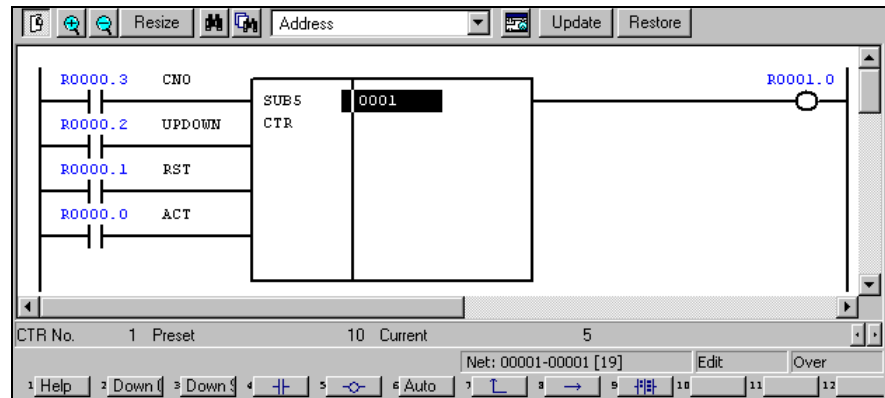

Fig. 3.5.28.2(a)

NOTE

All models are supporting the display of the CTR number, the preset value and current value on the status line. If the automatic input of the CTR parameter is supported, "Auto" will be displayed on the [F6] key.

3.6 EDITING STEP SEQUENCES

This section describes how to edit step sequence programs.

NOTE

Step sequence programs can be displayed and edited only when the current programmer mode (offline/online) is offline. To change the programmer mode to offline, select [Ladder] - [Online/Offline].

How to display the step sequence edit screen

Procedure

1. Select [View] - [Program List]. The [Program List] screen appears. (Usually, this screen appears automatically when a LAD program is created or opened.)

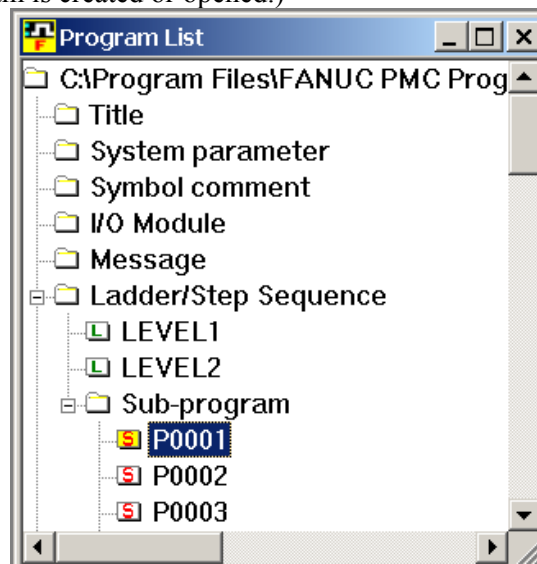

 Ladder program

 Step sequence program

Fig. 3.6 (a)

2. On the [Program List] screen, double-click the step sequence program you want to edit. Alternatively, select the step sequence program, and then press the [Enter] or [F10] key.

Summary of step sequence program edit screen

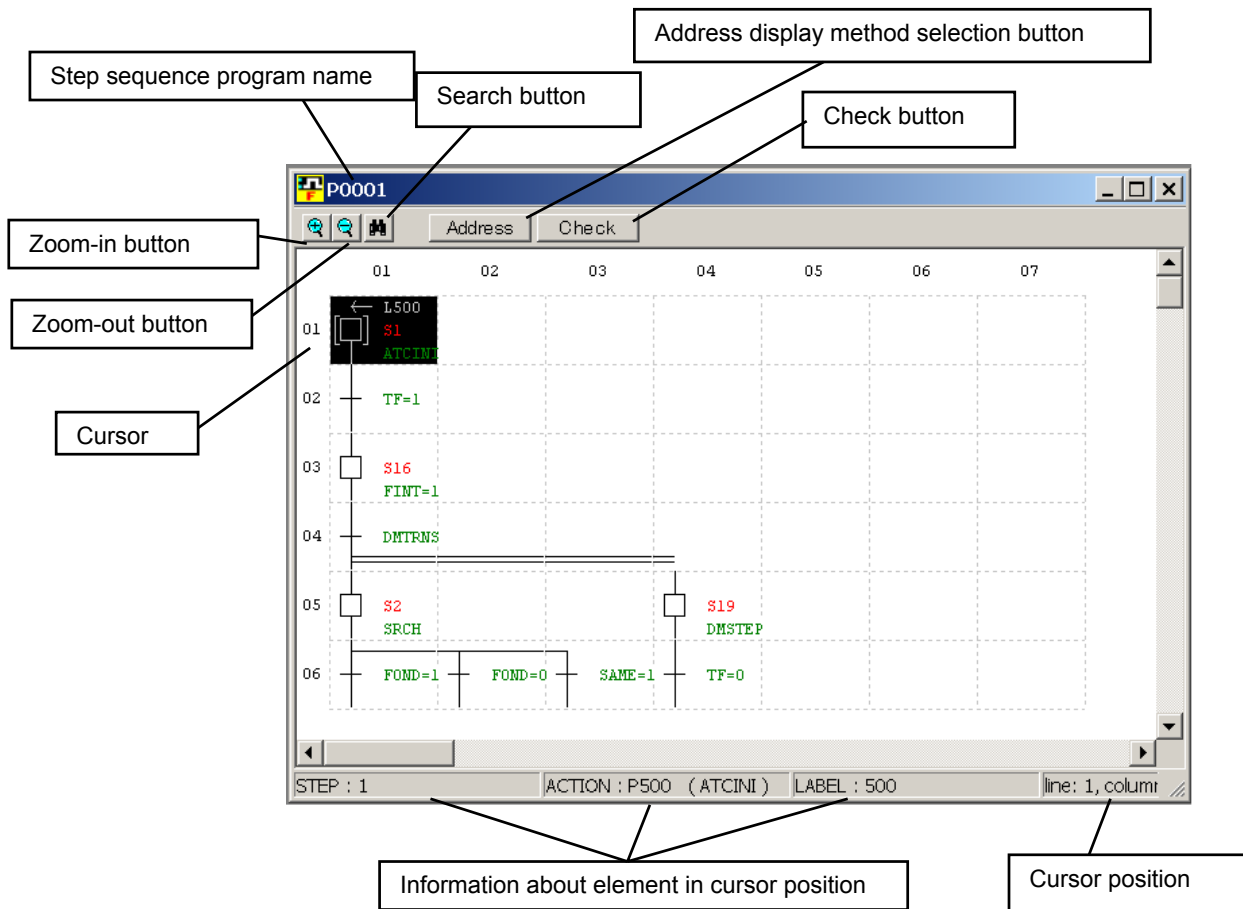

Fig. 3.6 (b)

Zoom-out button

Reduces the step ladder screen display.

Zoom-in button

Magnifies the step ladder screen display.

Search button

Searches for a step number and action.

Address display method selection button

Switches between address and symbol displays.

Check button

Check program syntax.

Information about element in the cursor position

Displays a step number, action (subprogram), and label number.

Cursor position

Displays the row and column of the current cursor position.

NOTE

The step sequence program edit screen consists of 32 horizontal elements by 64 vertical lines.

Soft keys

- When the Shift key is not pressed (the cursor is on the "processing step line")



Fig. 3.6 (c)

- When the Shift key is pressed (the cursor is on the "processing step line")

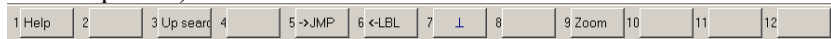

Fig. 3.6 (d)

- When the Shift key is not pressed (the cursor is on the "condition specification TR")



Fig. 3.6 (e)

- When the Shift key is pressed (the cursor is on the "condition specification TR")



Fig. 3.6 (f)

NOTE

To display soft keys, select [View] - [Softkey].

Context menu

Right-clicking the step sequence program edit screen displays this menu.

Cut	Ctrl+X
Copy	Ctrl+C
Paste	Ctrl+V
Delete	
Insert line	
Insert column	
Select line	
Select column	
<input type="checkbox"/> Step	F5
<input checked="" type="checkbox"/> Initial step	F6
<input type="checkbox"/> Block step	F7
Vertical line	F8
→ Jump	Shift+F5
← Label	Shift+F6
⌞ End	Shift+F7
List	
Zoom	Shift+F9
Check	F9
P500 Property	

Fig. 3.6 (g)

Shortcut keys

Table 3.6

Shortcut key	Function
[F3]	Search (downward)
[Shift] + [F3]	Search (upward)
[F5]	Enter step program (step line) Enter transition (transition line)
[Shift] + [F5]	Enter label jump (step line)
[F6]	Enter initial step program (step line) Enter beginning of selective branch (transition line)
[Shift] + [F6]	Enter jump-to label (step line) Enter end of selective branch (transition line)
[F7]	Enter block step program (step line) Enter beginning of parallel branches (transition line)
[Shift] + [F7]	Enter end of block step (step line) Enter end of parallel branch (transition line)
[F8]	Enter continuation line
[F9]	Check syntax
[Shift] + [F9]	Zoom
[Del]	Clear element
[Ctrl] + [C]	Edit - Copy
[Ctrl] + [F]	Edit - Search
[Ctrl] + [G]	Edit - Jump to specified position
[Ctrl] + [V]	Edit - Paste
[Ctrl] + [X]	Edit - Cut
[Home]	Display left end
[End]	Display right end
[Ctrl] + [Home]	Jump to beginning
[Ctrl] + [End]	Jump to end

3.6.1 Step Sequence Configuration

A step sequence program consists of the following elements:

Step

A step is a unit of processing in a program.



- A step number [Sn] necessary to control execution and a subprogram [Pm] that describes actual processing are defined for a step.
- Each step is always assigned with a step number. A duplicate step number cannot be used in a program.
- A step can be in any one of three logical states: running, stopping, and stopped. The running state is also called an active state. The stopping and stopped states are collectively referred to as inactive states.

Table 3.6.1

State		Processing	Sn.0
Active	Running	The step is active. The corresponding action program (subprogram) is running.	1
	Stopping	The step is shifting from running to stopped. The corresponding action program (subprogram) is executed only once. After this it is stopped.	0
Inactive	Stopped	The step is inactive. The corresponding action program (subprogram) is not running.	0

NOTE

The state of a specified step can be read through a contact; it cannot be written, however.

Sn.0 (where n represents a step number, which can take a value from 1 to 1000)

Step numbers are used in a program so that transition between steps can be controlled in detail.

Using step numbers makes it possible for any subprogram to detect the state of any step.

However, the use of step numbers adversely affects program transportability and ease of understanding. Do not use step numbers excessively.

Initial step

An initial step is a step that automatically becomes active when the program starts running. Except for this point, the initial step behaves in the same manner as ordinary steps. Control can be passed from a usual step to the initial step again. In this case, the initial step behaves in exactly the same manner as an ordinary step.



- A step number [Sn] necessary to control the execution and a subprogram [Pm] that describes the actual processing are defined for an initial step.
- All initial steps become active when no other step is running.
- Each block must have at least one initial step. It can have any number of initial steps.
- If a block has no initial step, it is not executed even if called.
- Each initial step is always assigned a step number. A duplicate step number cannot be used in a program.
- If there are initial steps in the middle of parallel branching, there must be at least one initial step in each flow.

Transition

A transition represents a condition under which transition occurs from one step to another.



- There must be only one transition between steps.
- The transition of processing from one step to another is carried out as described below:

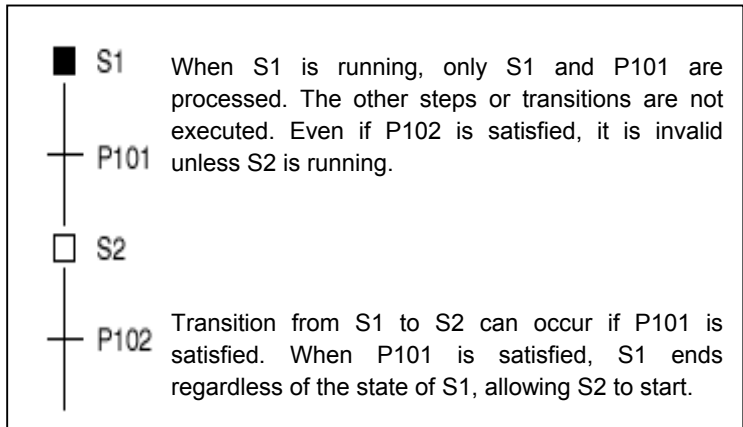

- When a signal becomes on in a transition, its state is held even after state transition occurs. So, if you do not want to maintain the state, you must turn off the signal, using another subprogram.

[Example of setting transition conditions]

In this example, after an M7 code is decoded using the DEC function instruction, control is passed to the next step.

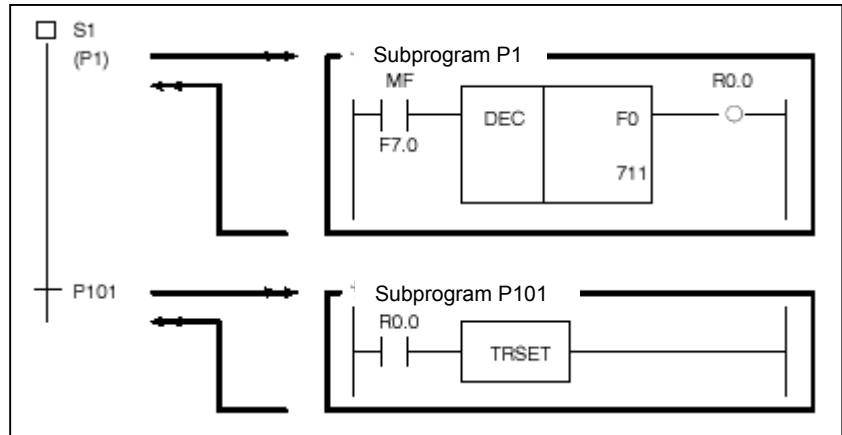

NOTE

The TRSET function instruction is intended to describe that a transition condition is satisfied. It is used in a subprogram that is called from the transition.

Beginning of selective branch

A branch occurs from one step to two or more steps, passing control to a step below a transition where the condition is satisfied.



- A transition is placed below a branch.
- A step leading to the first transition where the transition condition is satisfied becomes active.
- If transition conditions for more than one step are satisfied simultaneously, transition occurs to the leftmost step.
- A branch can occur to up to 16 flows.

End of selective branches

Two or more flows that branched out gather back into one flow.

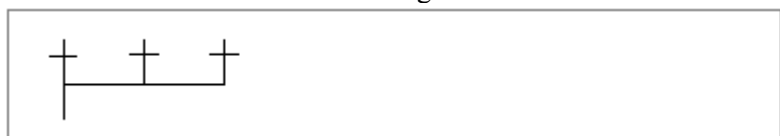

- The number of branching flows must match that of the gathering flows.

Beginning of parallel branch

A branch occurs from one step to two or more steps, which become active simultaneously.



- A transition is placed above a branch.
- After branching, all steps become active simultaneously and are executed.
- A branch can occur to up to 16 flows.

End of parallel branch

Two or more flows that branched out gather into one flow.



- How parallel flows gather again is explained below.

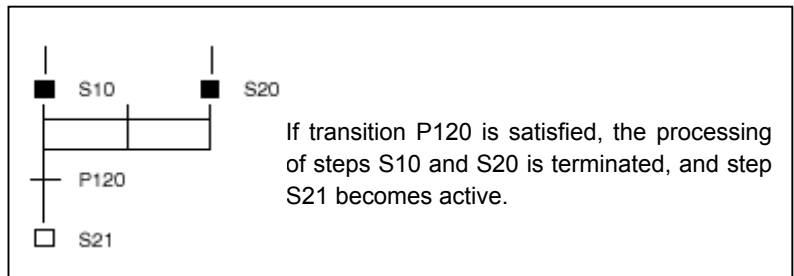

- How wait processing occurs is explained below.

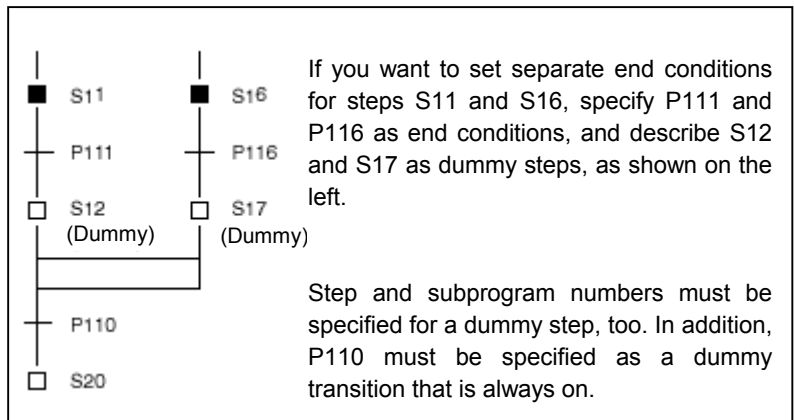
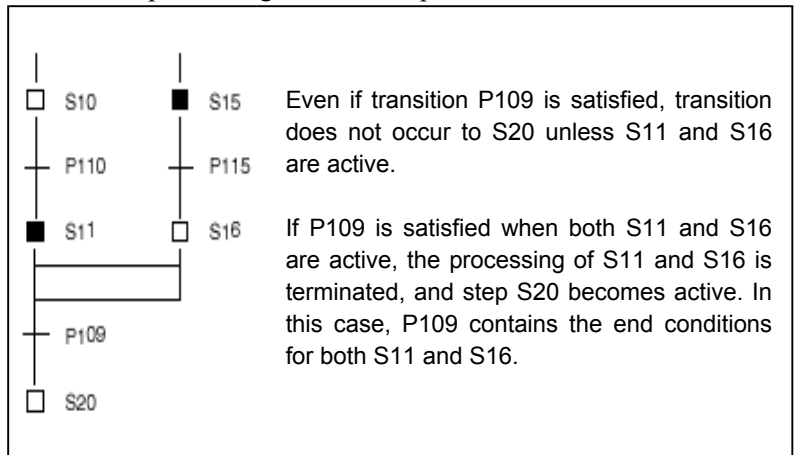

Jump

A jump is processed in conjunction with a transition to control the execution of steps.



- A jump-to label [Ln] is specified.
- The step at a jump destination becomes active.
- The jump destination must be within the same program.
- It is impossible to jump from outside to inside a parallel branch and vice versa.
- It is impossible to jump from one parallel branch flow to another.

Label

A label represents a jump destination.



- A jump-to label [Ln] is defined.

Block step

The block step is a step for representing a subprogram described with step sequences.



- A step number [Sn] necessary to control execution and a subprogram [Pm] that describes actual processing are defined for a block step.
- A step number must be assigned to a step.
- Duplicate step numbers cannot be used in a program.
- There must always be a transition below a block step.

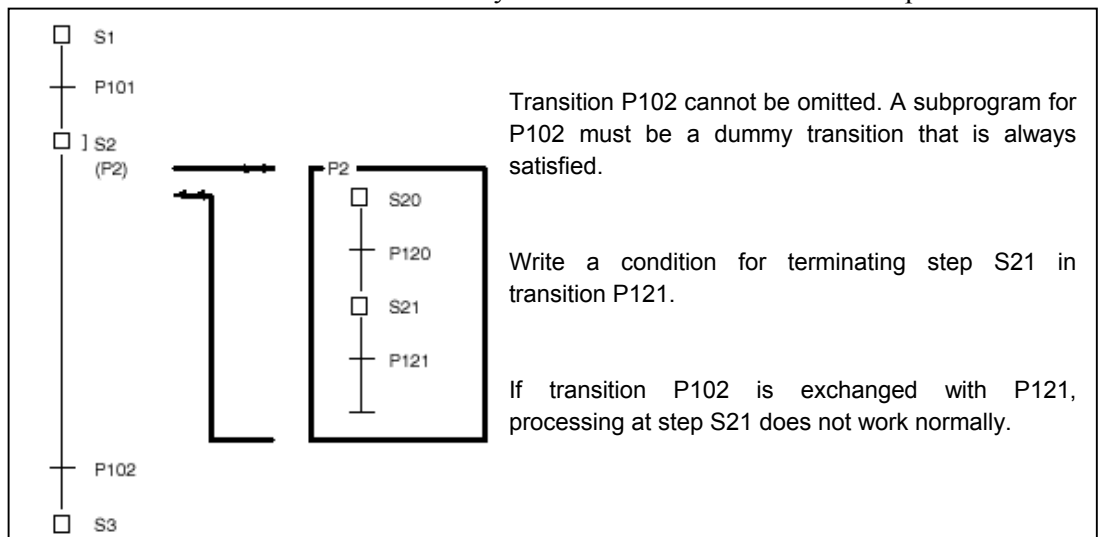

Initial block step

The initial block step is an initial step in a block.



- A step number [Sn] necessary to control execution and a subprogram [Pm] that describes actual processing are defined for an initial block step.
- The function and representation of the initial block step are the same as for the initial step.

End block step

The end block step represents the end of the steps in a block.



- An end block step is created to end block step processing.
- Each block must have at least one end block step. It can have any number of end block steps.

3.6.2 Entering Steps

Procedure

1. Position the cursor to the point where you want to enter a step.
2. Press the [F5] key.

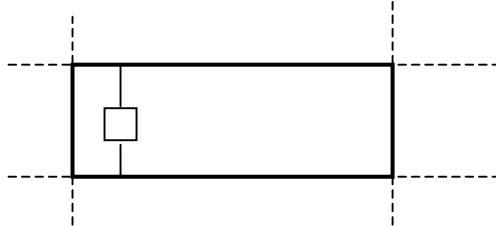

3. The [Action] dialog box appears. Enter the necessary items. (An idle step number is used automatically.)

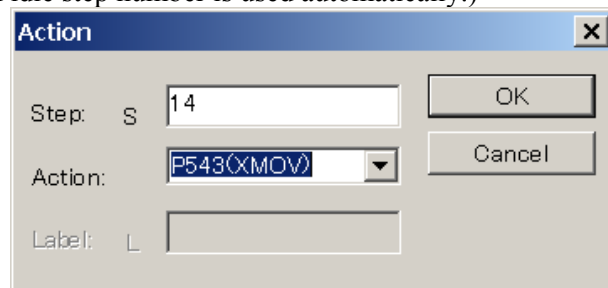
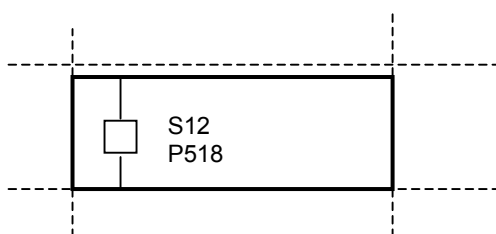

Fig. 3.6.2

4. After you finish entering the items, press the <OK> button.



NOTE

To change a step number, action, or label, position the cursor to the desired element, and then press the [Enter] key. Alternatively, double-click the element. The [Action] dialog box appears.

3.6.3 Entering Transitions

Procedure

1. Position the cursor to the point where you want to enter a transition.
2. Press the [F5] key.

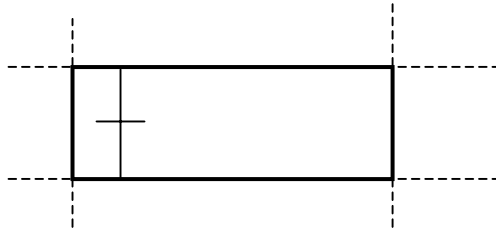

3. The [Action] dialog box appears. Enter the desired action.

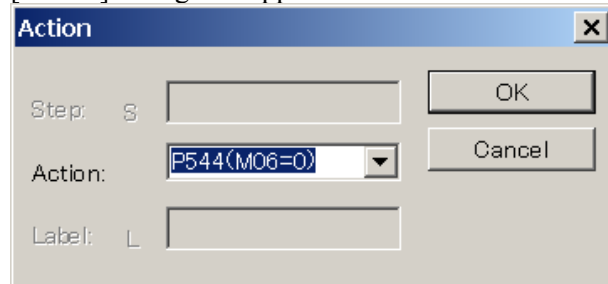
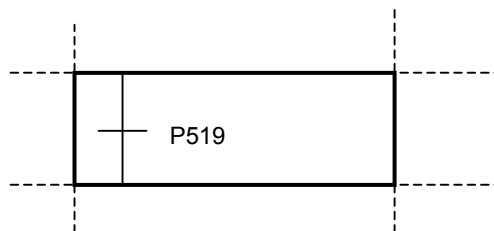

Fig. 3.6.3

4. After you finish entering the action (subprogram), press the <OK> button.



NOTE

To modify an action, position the cursor to the relevant element, and then press the [Enter] key. Or, double-click the element. The [Action] dialog box appears.

3.6.4 Beginning of Selective Branch

Procedure

1. Position the cursor to the point where you want to enter the beginning of a selective branch.

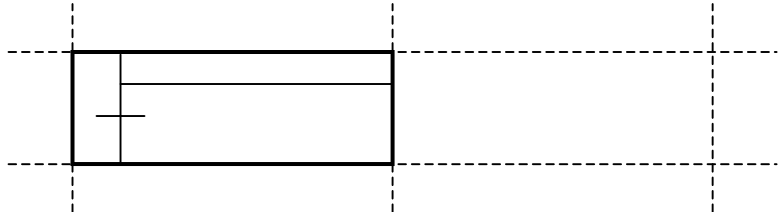

2. Press the [F6] key.

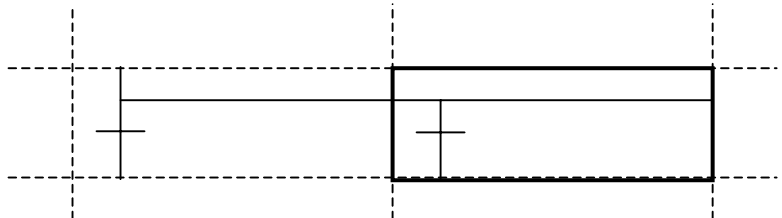

3.6.5 End of Selective Branch

Procedure

1. Position the cursor to the point where you want to enter an end of selective branch.
2. Hold down the [Shift] key, and then press the [F5] key.

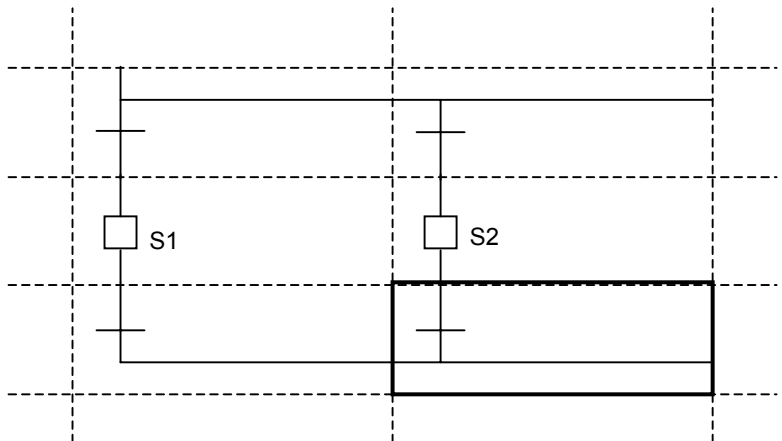

3.6.6 Beginning of Parallel Branch

Procedure

1. Position the cursor to the point (transition line) where you want to enter the beginning of parallel branch.
2. Press the [F7] key.

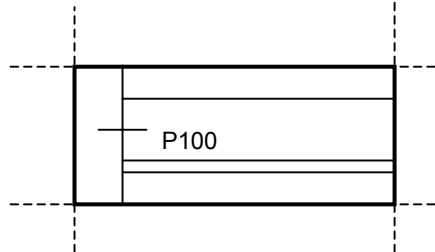

3.6.7 End of Parallel Branch

Procedure

1. Position the cursor to the point where you want to enter the end of a parallel branch.
2. Hold down the [Shift] key, and then press the [F6] key.

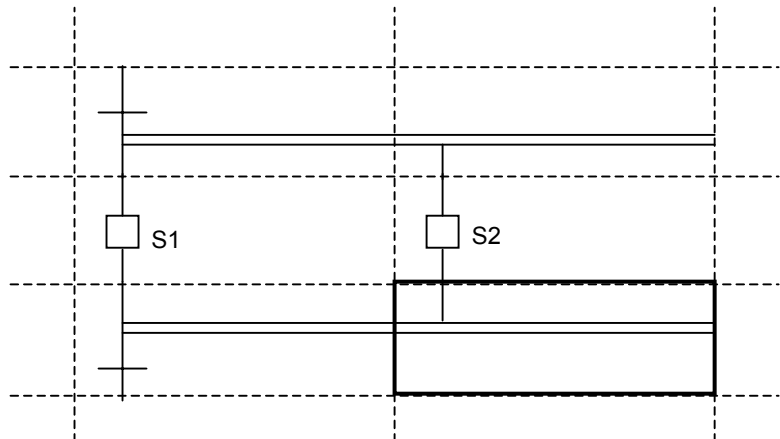

3.6.8 Specifying Jump-to Label

Procedure

1. Position the cursor to the point (step line) where you want to enter a jump-to label (a label to which a jump is to be made).
2. Hold down the [Shift] key, and then press the [F6] key.

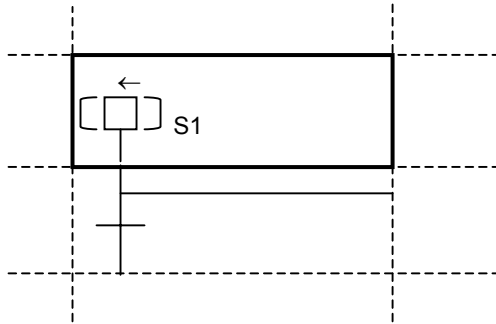

3. The [Action] dialog box appears. Enter the label name.

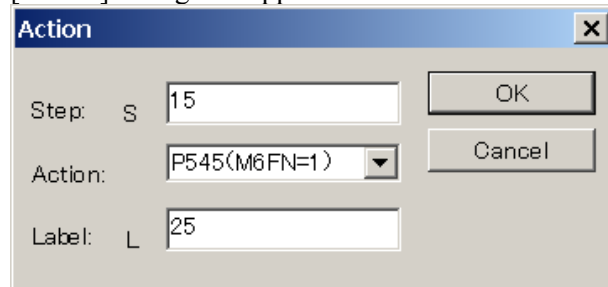
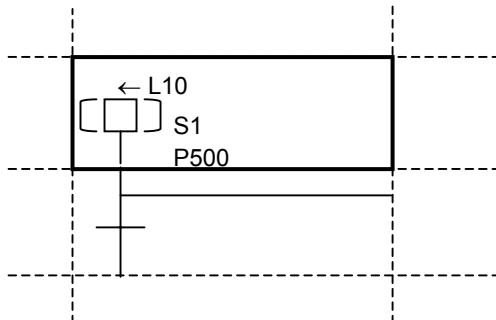

Fig. 3.6.8

4. After you finish entering the label name, press the <OK> button.



3.6.9 Specifying Label Jump

Procedure

1. Position the cursor to the point (step line) where you want to enter a label jump.
2. Hold down the [Shift] key, and then press the [F5] key.

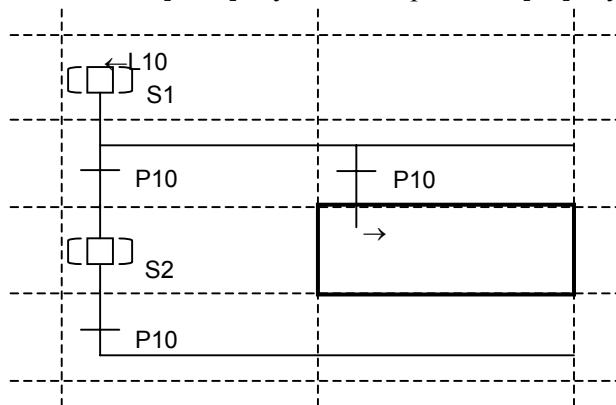

3. The [Action] dialog box appears. Enter the label.

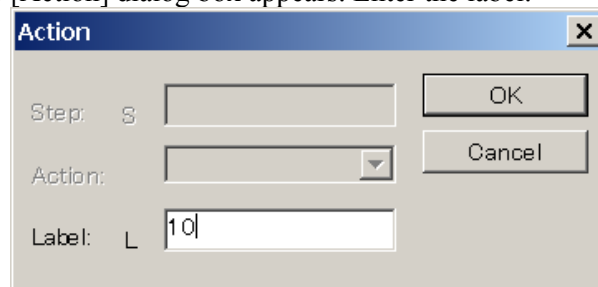
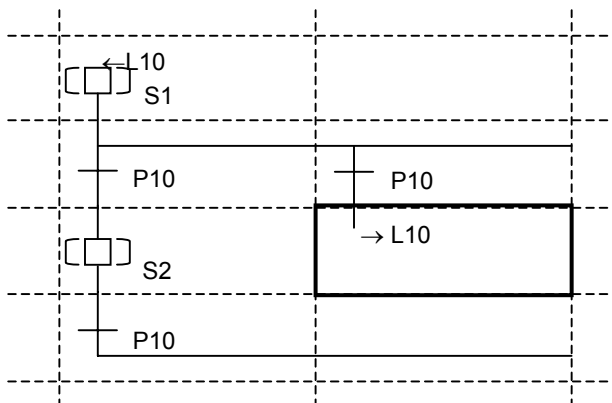

Fig. 3.6.9

4. After you finish entering the label, press the <OK> button.



3.6.10 Checking Syntax

Procedure

1. Press the [F9] key.

- If no error is found, the following dialog box appears.



Fig. 3.6.10 (a)

- If an error is found, the following dialog box appears.

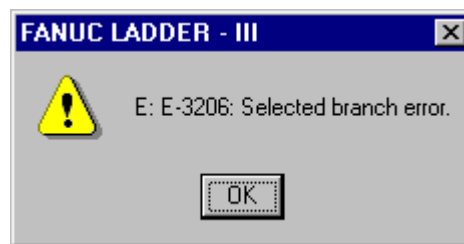

Fig. 3.6.10 (b)

3.6.11 Adding Step Sequence Subprograms

This subsection describes how to add step sequence subprograms.

Procedure

1. Right-click the program list screen, and then click [Add sub-program F9].

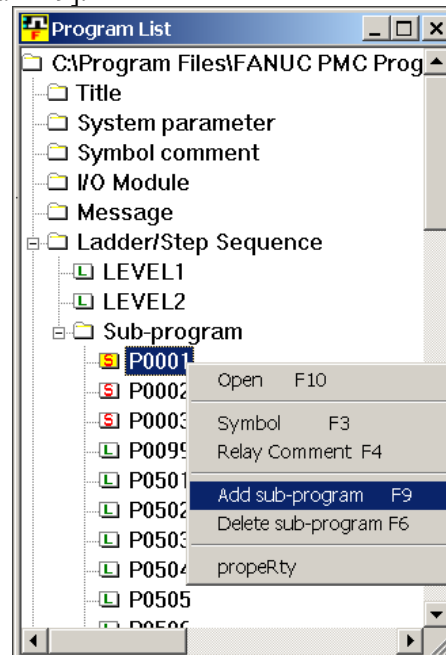

Fig. 3.6.11 (a)

2. The [Add sub-program] dialog box appears.

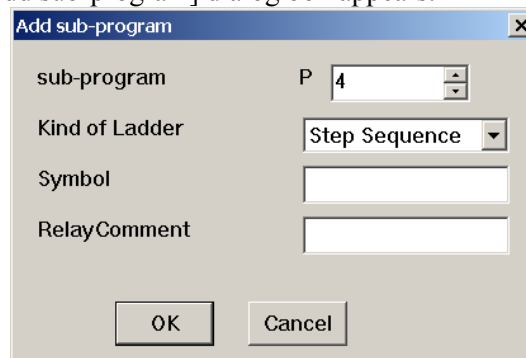

Fig. 3.6.11 (b)

3. Enter [sub-program].
4. Select [Step Sequence] from [Kind of Ladder].
5. Enter [Symbol] and [RelayComment], and then click the <OK> button.
6. The step sequence subprogram is added, and the screen for the added subprogram appears.

3.6.12 Deleting Step Sequence Subprograms

This subsection describes how to delete step sequence subprograms.

Procedure

1. Position the pointer to the step sequence subprogram that you want to delete from the program list screen, and then right-click. Then, click [Delete sub-program F6].

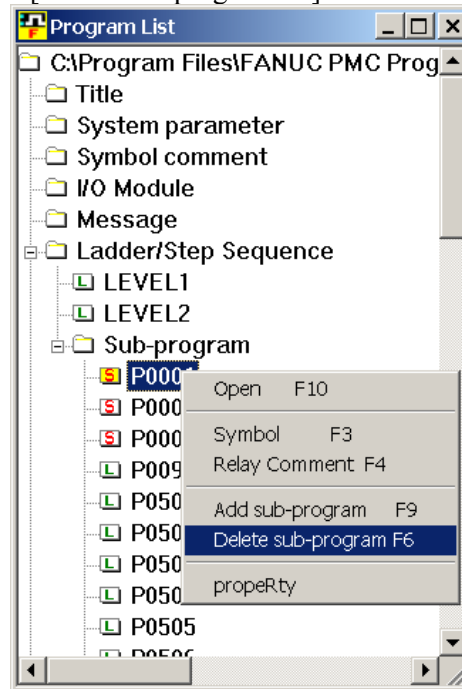

Fig. 3.6.12 (a)

2. The following dialog box appears. To delete, click <Yes>.

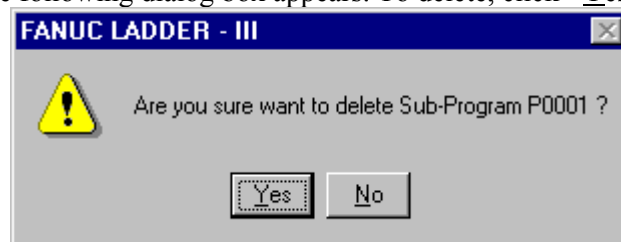

Fig. 3.6.12 (b)

3.6.13 Search

This subsection describes the step sequence program search function.

Procedure

1. Choose [Find] from the [Edit] menu.
The [Find] screen appears.

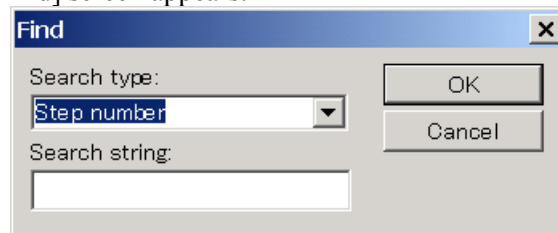

Fig. 3.6.13

- 1-1 **Search type**
Select Step number, Label number, or Symbol/address.
 - 1-2 **Search string**
Enter a character string to be searched for.
No wildcard can be used.
2. Execute search operation.
For downward search operation, click the <OK> button. For upward search operation, click the <OK> button while holding down the [Shift] key.

3.7 EDITING SYMBOLS AND COMMENTS

This section describes how to edit symbols and comments.

NOTE

Symbols and comments can be displayed and edited only when the current programmer mode (offline/online) is offline. To change the programmer mode to offline, select [Ladder] - [Online/Offline].

3.7.1 Symbol and Comment Data

Names and comments can be assigned to the input signals and internal relays used in sequence programs.

These names and comments are generically referred to as symbol and comment data.

- (1) PMC model which does not support the multiple comments.

Table 3.7.1 (a)

	Definition	Display
Symbol	Character string assigned to a contact or coil (on a one-to-one basis) and used in place of a PMC address	INPUT
Relay comment	Character string assigned to a contact or coil to describe the contents at a PMC address	 X0.0 Y0.0 RELAY RELAY COMMENT COMMENT
Coil comment (conventional comment)	Character string assigned to a coil to describe it	 Y0.0 HERE IS COIL COIL COMMENT
Net comment	Assigned to an arbitrary position between nets to describe the program	 (* HERE IS NET *) (* COMMENT *)

Table 3.7.1 (b)

	Symbol	Relay comment	Coil comment
Usable characters	ASCII characters (except lowercase letters)	ASCII characters Kana and Kanji Half-size kana	ASCII characters Kana and kanji Half-size kana
Maximum number of characters	16 bytes	16 bytes	30 bytes
Maximum number of units that can be registered	20,000	20,000	20,000
Duplicate definition	Not allowed	Allowed	Allowed

Table 3.7.1 (c)

	Net comment
Usable characters	ASCII characters, kana, kanji, half-size kana
Number of usable steps	2 steps/net comment
Maximum number of characters	64 bytes/line or 4095 bytes/net comment
Maximum number of lines	100 lines/net comment
Maximum number of units that can be registered	Approx. 20,000

(2) PMC model which supports the multiple comments.

Table 3.7.1 (d)

	Definition	Display
Symbol	Character string assigned to a contact or coil (on a one-to-one basis) and used in place of a PMC address	<p>INPUT</p> 
Comment (for a contact and a coil)	Character string assigned to a contact and a coil to describe it. One of comment sets is displayed.	
Net comment	Assigned to an arbitrary position between nets to describe the program	

Table 3.7.1 (e)

	Symbol	Coil comment
Usable characters	ASCII characters (except lowercase letters)	ASCII characters Kana and kanji Half-size kana
Maximum number of characters	16 bytes	30 bytes
Maximum number of units that can be registered	40,000	40,000
Duplicate definition	Not allowed	Allowed

Table 3.7.1 (f)

	Net comment
Usable characters	ASCII characters, kana, kanji, half-size kana
Number of usable steps	2 steps/net comment
Maximum number of characters	64 bytes/line or 4095 bytes/net comment
Maximum number of lines	100 lines/net comment
Maximum number of units that can be registered	Approx. 20,000

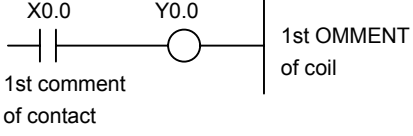
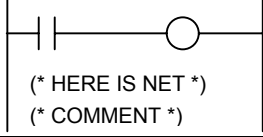
NOTE

- 1 The maximum number of characters or lines, whichever is reached first, functions as a limit.
- 2 Relay comments are used only on the Ladder Edit screen of the FANUC LADDER-III. They are not included in a memory-card-type file generated by the compile function.
- 3 In the PMC model which can input the lowercase letters to the symbol, the symbol with a different only capital letter and small letter cannot be registered.
Example) “OverTravel” and “OVERTRAVEL” cannot be registered.

3.7.2 Procedure

- 1 Double-click the <Symbol comment> item on the [Program List] screen. The [SYMBOL/COMMENT] screen appears.

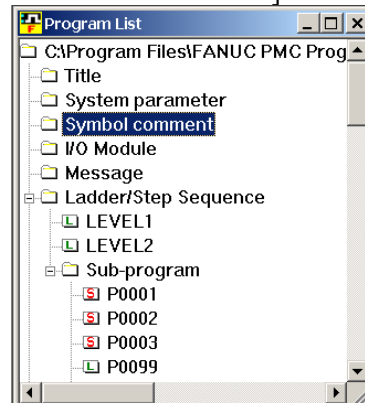

Fig. 3.7.2(a)

- PMC model which does not support the multiple comments

The screenshot shows the 'Symbol Comment Editing' window. On the left, there is a tree view with 'Registered symbol / comment' expanded, showing 'Machine signal', 'NC interface', 'PMC parameter', and 'etc'. The main area is a table with the following data:

No.	Address	Symbol	RelayComment	CoilComment
*1	X0000.0	*IT1	イン知ツカ1	INTERLOCK 1ST
*2	X0000.1	*IT2	イン知ツカ2	INTERLOCK 2ND
*3	X0000.2	*IT3	イン知ツカ3	INTERLOCK 3RD
*4	X0000.3	*IT	イン知ツカ	INTERLOCK
*5	X0000.4	SYNC4	トリキ4	SYNCHRONIZE 4TH
*6	X0000.5	TSKP	ツールスキップ	TOOL SKIP
*7	X0000.6	TRST	ツールリセット	TOOL RESET
*8	X0000.7	*CNC G	CNCセネラル	CNC GENERAL
*9	X0001.0	EAX1	PMCツカ1	PMC AXIS 1ST

At the bottom right of the window, it says 'Symbol: 10 / 10 Coil comment: 105 / 105 Selected'.

Fig. 3.7.2(b)

- In case of the PMC model supported to multiple comments. (30i/31i/32i-A)

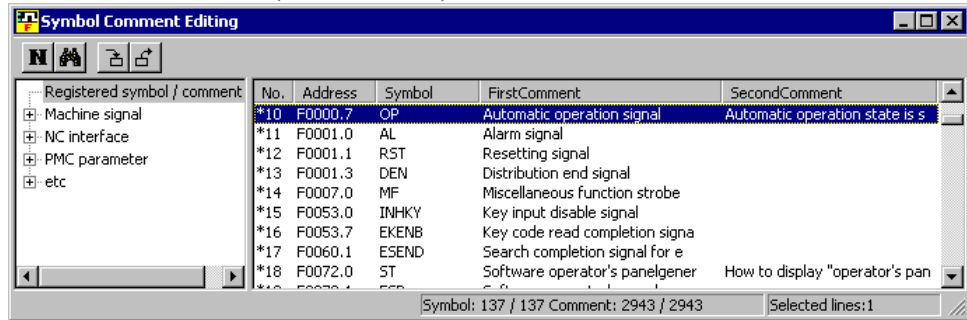

Fig. 3.7.2(c)

- In case of the PMC model supported to multiple comments. (30i/31i/32i-A Extended function)

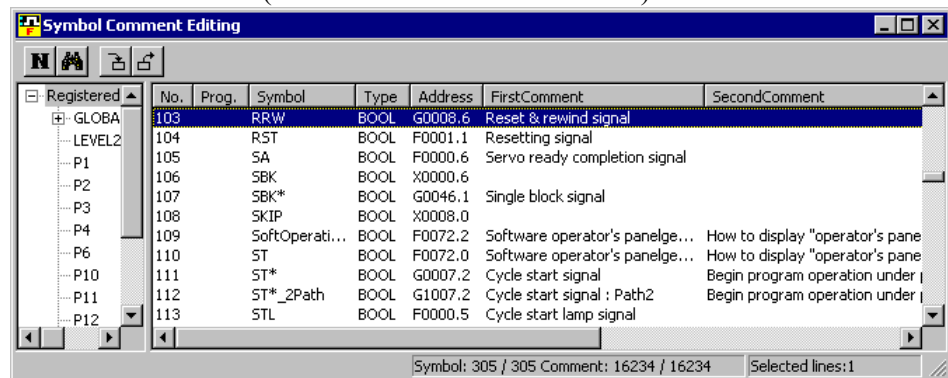

Fig. 3.7.2(d)

NOTE

When you check [Ignore too long strings of the symbol], the number of symbols that can be registered and the size of coil comments vary because the symbols that exceed the limit are assumed to be absent.

- 2 Click the <Add New Data> button on the toolbar.



< Add New Data> button

The [New Data] screen appears.

- PMC model which does not support the multiple comments

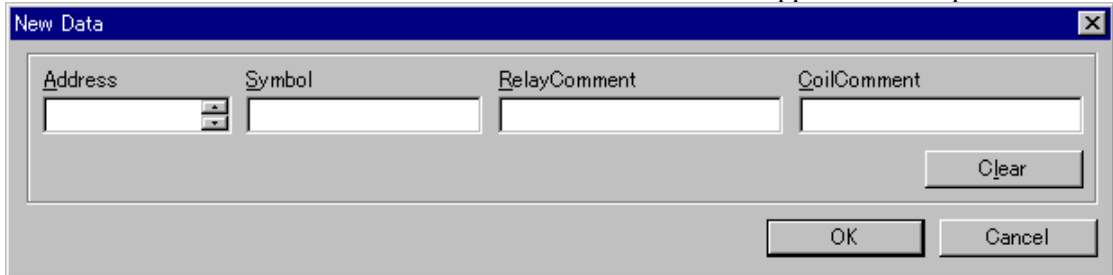

Fig. 3.7.2 (e)

- PMC model which supports the multiple comments

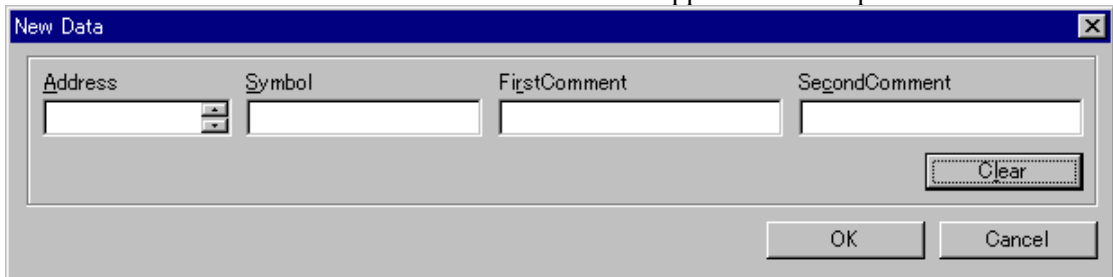

Fig. 3.7.2 (f)

- 2-1 Set the necessary data.

Address

Symbol

Relay Comment or First Comment

Coil Comment or Second Comment

- To register the entered data, click the <OK> button.

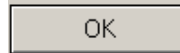

<OK> button

To quit without registering, click the <Cancel> button.

- 3 To close the [Symbol/COMMENT] screen, click the <Close> button.



<Close> button

This operation has nothing to do with whether to save the data entered on the [New Data] screen for [SYMBOL/COMMENT].

See Section 3.11, "Saving Programs," for an explanation about how to save data entered on the [New Data] screen for [SYMBOL/COMMENT].

See Section 3.12 "Closing Programs," for an explanation about how to close the sequence program without saving data entered on the [New Data] screen for [SYMBOL/COMMENT].

3.7.3 Toolbar



<1><2> <3><4>

Fig. 3.7.3

- <1> <Add New Data> button
The [New Data] screen appears.
- <2> <Search> button
The [Search] screen appears.
- <3> <Import> button
The [Import] screen appears.
- <4> <Export> button
The [Export] screen appears.

3.7.4 Context Menu

Right-click the [SYMBOL/COMMENT] screen. The following context menu appears.

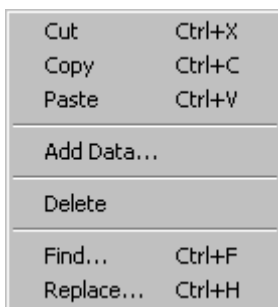

Fig. 3.7.4(a)

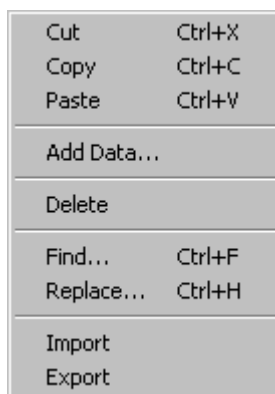

Fig. 3.7.4(b) 30i/31i/32i-A

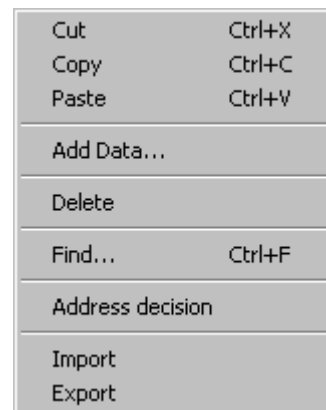

Fig. 3.7.4(c) 30i/31i/32i-A Extended function

3.8 EDITING MESSAGES

Using the DISPB (SUB 41) function instruction enables the display of any message on the CRT or LCD screen of the CNC. This section describes how to create messages.

NOTE

Messages can be displayed and edited only when the current programmer mode (offline/online) is offline. To change the programmer mode to offline, select [Ladder] - [Online/Offline].

3.8.1 Procedure

- 1 Double-click the <Message> item on the [Program List] screen. The [Message Editing] Screen appears.

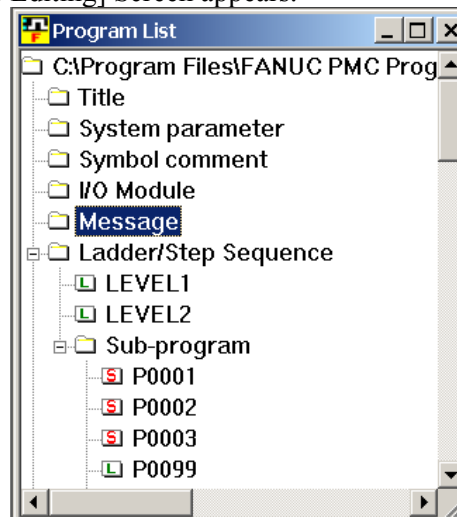

Fig. 3.8.1 (a)

2. Japanese-language input mode

2-1 Edit messages using the Japanese-language input function of Windows. Enter kanji, kana, and half-size kana characters.

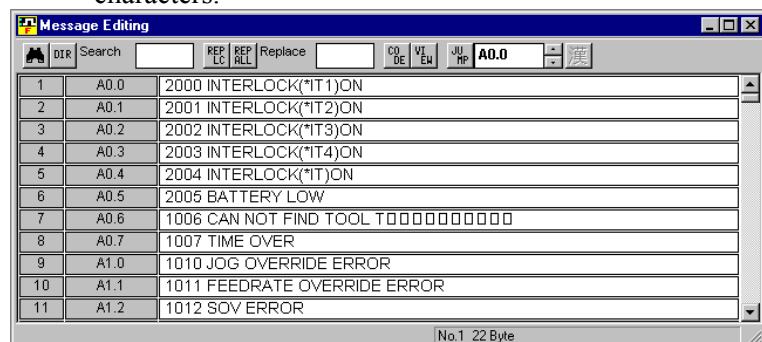

Fig. 3.8.1 (b)

NOTE

In Japanese-language input mode, Numeric data can be input according to the setting in “%%%flset.cnf” file of the install folder. (See subsection 3.8.4, “New line character, Numeric data” for details.)

3. Code input mode

3-1 Clicking the <CODE> button enables message editing using character code data. Edit and check data in code format.

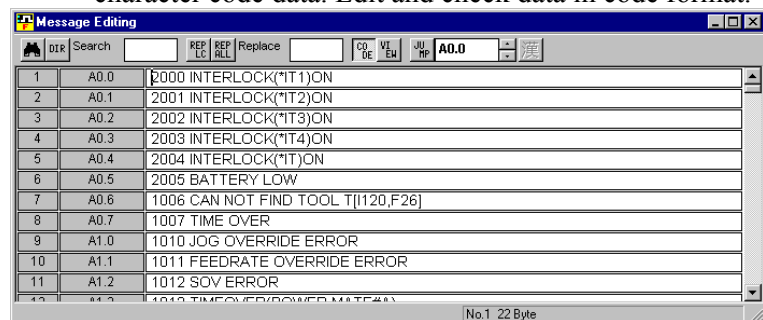
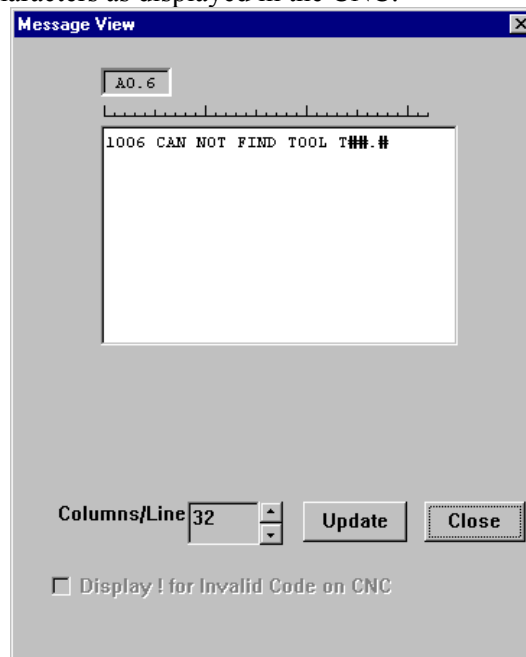

Fig. 3.8.1 (c)

4. [Message View] box

4-1 Clicking the <VIEW> button displays the [Message View] box. You can check the new line code and special characters as displayed in the CNC.



5. To close the [Message Editing] screen, click the <Close> button.



<Close> button

This operation has nothing to do with whether to save the data entered on the [Message Editing] screen.

See Section 3.11, "Saving Programs," for explanations about how to save data entered on the [Message Editing] screen.

See Section 3.13, "Closing Programs," for an explanation about how to close the sequence program without saving the data entered on the [Message Editing] screen.

3.8.2 Models and Quantity of Usable Characters

The types of characters usable in message text vary depending on the CNC/PMC model. See the following table for details.

Table 3.8.2

Characters that can be entered		
JIS level-1/-2 kanji set	Half-size kana	Alphanumeric characters
Some kanji characters cannot be displayed. FANUC LADDER-III cannot check whether they can be displayed.	Usable	Usable

NOTE

- 1 Lowercase letters (a to z) are converted to uppercase (A to Z) when entered.
- 2 Up to 65,535 characters can be used in messages in total with PMC-SA1, SA3, SA5, SB3, SB4, SB5, SB6, SC3, and SC4. Specifically, the number of characters in messages are counted starting at message No. 1, when the message edit function ends. Only the first 65,535 characters are accepted. Others are deleted.
- 3 With the PMC-SB7, up to 512,000 characters can be used in messages in total, but the number of characters is limited depending on the total capacity of the sequence programs.

3.8.3 Memory Addresses Required to Display Messages

The range of the addresses that can be specified and the number of messages are different for each PMC. Refer to the Ladder Language Programming Manual.

3.8.4 New Line Character, Numeric Data

The input method of New line character and Numeric data is decided according to the input mode and the content of MSG_EDIT_VAL (the setting in “%%flset.cnf” file).

- The setting of MSG_EDIT_VAL in “%%flset.cnf” file.

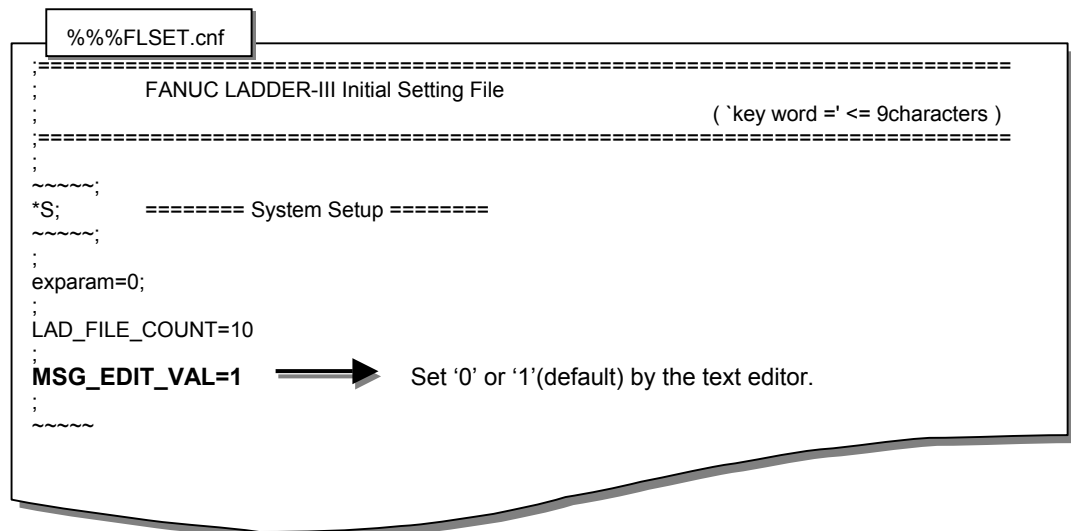

- Input method of New line character

Input mode	MSG_EDIT_VAL	New line character	
		Input	Display
Japanese-language input mode	1	<Enter> key or @0A@	
	0	<Enter> key	•
Code input mode	1	@0A@	@0A@
	0	@0A@	@0A@

- Input method of Numeric data
 - (a) Numeric data format

[Ibid, ___]

Memory address that the numerical data is stored
The address must be of binary format.

Set the "bid" data after character "I":

- b : Number of bytes (1, 2, or 4)
- i : Number of digits in the integer part (0 to 8)
- d : Number of digits in the fractional part (0 to 8)

(Example)

The following message includes 3 digits tool number at the spindle and the offset data (_ . _) for this tool. And these data are contained in memory address of 2bytes:

SPINDLE TOOL No. = [I230, ___]

OFFSET DATA = [I212, ___]

NOTE

- 1 Sum of integer part digits and fractional part digits must be within 8.
- 2 Do not use any space between the brackets, [].
- 3 With the view function, as many number signs (#) as the number of specified digits are displayed in bold. (Example: **###.##**).

- (b) Input method of Numeric data

Input mode	MSG_EDIT_VAL	Numeric data	
		Input	Display
Japanese-language input mode	1	[Ibid,○○○○]	[Ibid,○○○○]
	0	NA	●●●●●●●●
Code input mode	1	[Ibid,○○○○]	[Ibid,○○○○]
	0	[Ibid,○○○○]	[Ibid,○○○○]

- (c) Input method of character '[' , ']' and '@'
- In the numeric data input, Character '[' and ']' are used as a delimitation character. The input method of character '[' , ']' and '@' in the each input mode is as follows.

Input mode	MSG_EDIT_VAL	'['		']'		'@'	
		Input	Display	Input	Display	Input	Display
Japanese-language input mode	1	@5B@	@5B@	@5D@	@5D@	@40@	@40@
	0	[[]]	@	@
Code input mode	1	@5B@	@5B@	@5D@	@5D@	@40@	@40@
	0	@5B@	@5B@	@5D@	@5D@	@40@	@40@

3.8.5 Tool Bar



Fig. 3.8.5

- <1> Search button
Searches for a character string.
- <2> Search direction button
Specifies the direction (upward or downward) in which a search is to be made.
- <3> Find what edit box
Lets you specify what to find.
- <4> Replace button
Replaces the occurrences of a specified character string one by one.
- <5> Replace all button
Replaces all the occurrences of a specified character string.
- <6> Replace with edit box
Lets you specify a character string for substituting an occurrence of a specified character.
- <7> Code input mode button
Lets you specify message data in code format. Enter a message, using numeric code (JIS).
Example: 2100 日本語表示
2100 @02467C4B5C386C493D4C2801@
- <8> View button
Lets you confirm that the message character string is in such a format that it is continued on a new line.
It is possible to specify the number of characters to be displayed per line (32 to 80 characters).
- <9> Jump button
Causes a jump to a specified address (A0.0 to A24.7/A124.7).
- <10> Jump address character string edit box
Lets you specify a character string as a jump address.
- <11> Jump address value up/down button
Increases or decreases the jump address value.
- <12> Invalid kanji character check button
Searches for kanji characters not displayable on the NC downward starting at the cursor position. (When search operation reaches the end, search operation resumes from the beginning.)
This button is enabled only with those PMC models that have a VGA indicator.

3.8.6 Status Bar



Fig. 3.8.6

<1> The status bar displays the number of bytes in a message on the current line (that line with a caret).

3.8.7 Shortcut keys

Table 3.8.7

Shortcut key	Corresponding function
[F3]	Search
[Shift]+[F3]	Search direction
[F4]	Replace
[Shift]+[F4]	Replace all
[F5]	Code input mode
[F7]	View
[F9]	Invalid kanji character check
[Ctrl]+[G]	Jump
[Ctrl]+[Z]	Edit - Undo
[Ctrl]+[X]	Edit - Cut
[Ctrl]+[C]	Edit - Copy
[Ctrl]+[V]	Edit - Paste
[Ctrl]+[Home]	Move to the first display line
[Ctrl]+[End]	Move to the last display line
[Home]	Move to beginning of line
[End]	Move to end of line
[PageUp]	Move up 10 lines
[PageDown]	Move down 10 lines
[↑]	Move up one line
[↓]	Move down one line

3.9 EDITING I/O MODULE ASSIGNMENT

This section describes how to set and delete an address for each module in an I/O unit.

NOTE

I/O module assignment can be displayed and edited only when the current programmer mode (offline/online) is offline. To change the programmer mode to offline, select [Ladder] - [Online/Offline].

3.9.1 Procedure

- 1 Double-click the <I/O Module> item on the [Program List] screen.

The [Edit I/O Module] screen appears.

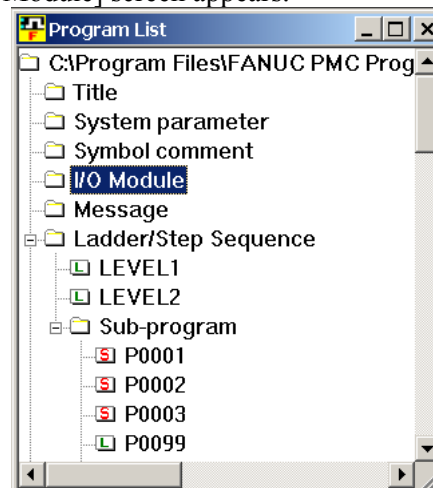

Fig. 3.9.1 (a)

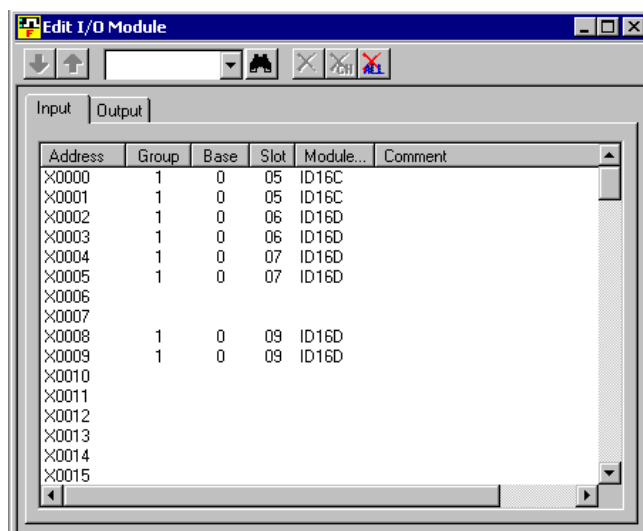

Fig. 3.9.1 (b)

3. CREATING AND EDITING SEQUENCE PROGRAMS

1-1 Double-click the line that you want to edit. The [Module] screen appears.

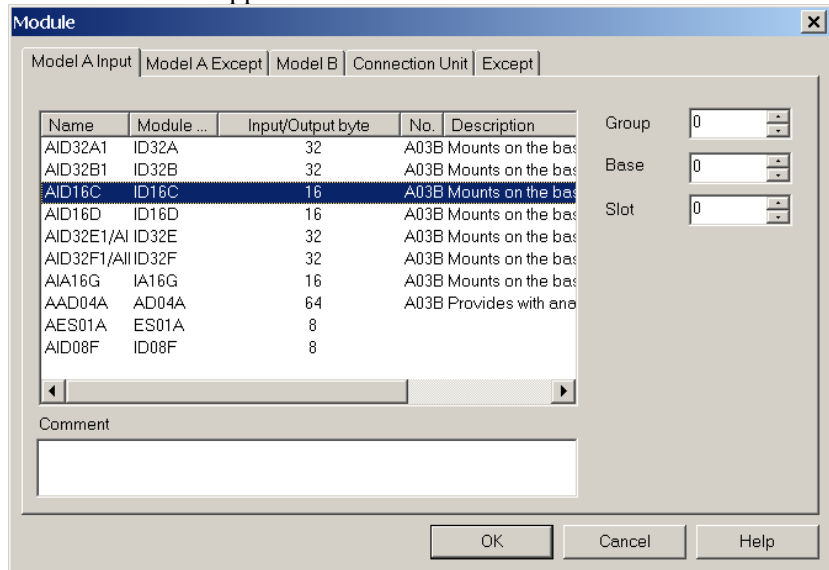

Fig. 3.9.1 (c)

1-2 Select a module name from those that can be specified. Set the following data.

Group

Base

Slot

Comment

NOTE

I/O Unit MODEL-B assignment is carried out as follows:

[GROUP]: To be set with a group number within a configuration.

[BASE]: To always be set to 0.

[SLOT]: To be set to a unit number for the I/O Unit-B. To be set with 0, however, when information '##' about power-on/-off is assigned.

To assert the data you entered, click the <OK> button.



<OK> button

To ignore the data, click the <Cancel> button.
The [Edit I/O Module] screen appears.

- 2 To close the [Edit I/O Module] screen, click the <Close> button.



<Close> button

This operation has nothing to do with whether to save the data entered on the [Module] screen.

See Section 3.11, "Saving Programs," for an explanation about how to save data entered on the [Module] screen.

See Section 3.13, "Closing Programs," for an explanation about how to close the sequence program without saving the data entered on the [Module] screen.

3.9.2 Tool bar



Fig. 3.9.2

- <1> Next channel
- <2> Previous channel
- <3> Search
- <4> Delete
- <5> Delete channel
- <6> Delete all

3.9.3 Shortcut Keys

Table 3.9.3

Shortcut key	Corresponding function
[Ctrl]+[F]	Search

3.10 EDITING SYSTEM PARAMETERS

This section describes how to edit system parameters.

NOTE

System parameters can be displayed and edited only when the current programmer mode (offline/online) is offline. To change the programmer mode to offline, select [Ladder] - [Online/Offline].

3.10.1 Procedure

1. Double-click the <System parameter> item on the [Program List] screen. The [Edit System Parameter] screen appears.

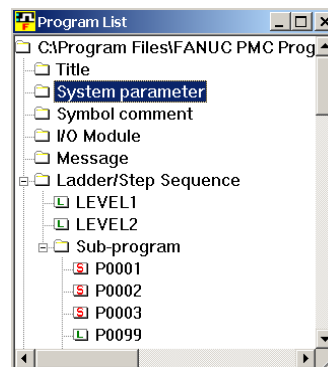

Fig. 3.10.1 (a)

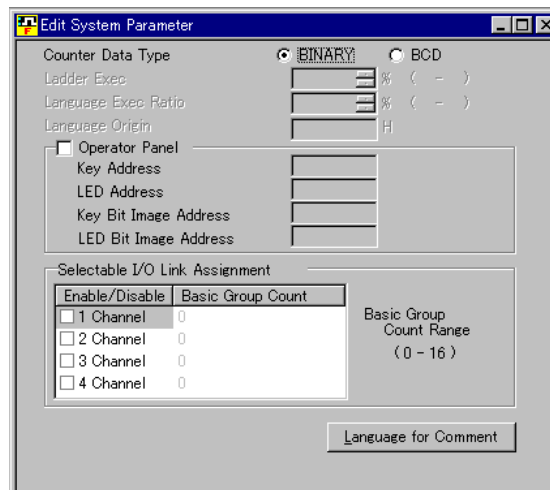

Fig. 3.10.1 (b)

1-1 Set the necessary data.

Counter Data Type

Initial value: BINARY

Set the format of the counter value to be used in the CTR function instruction as binary or BCD.

Ladder Exec

(Valid only with the PMC-SC3/SC4, PMC-QC, PMC-NB/NB2, and PMC-SB7)

Initial value: 100

Setting: 1 to 150

Set an increment for the processing time for ladder levels 1 and 2. Setting this parameter reduces the ladder scan time, thus quickening ladder processing.

The ladder execution time takes the value described below out of 8 ms.

If 100% is specified, the processing time for levels 1 and 2 is 5 ms.

If 150% is specified, the processing time for levels 1 and 2 is 7.5 ms.

Note that increasing the ladder execution time decreases the processing time in "PMC Screen Display Time", "Language Program Processing Time", and "Ladder Level 3".

Language Exec Ratio

(Valid only with the PMC-SC3/SC4, PMC-QC, and PMC-NB/NB2)

Initial value: 50

Setting: 0 to 99

This parameter sets a ratio for dividing the processing time in "PMC Screen Display Time", "Language Program Processing Time", and "Ladder Level 3", because the language program and the PMC screen display have the same priority.

Setting this parameter makes it possible to run the language program cyclically, even when the PMC screen display is active.

Language Origin

(Valid only with the PMC-SC3/SC4, PMC-QC, and PMC-NB/NB2)

Initial value: 000000

Setting: Address within the language program storage area

Set the start address of the link control statement data in the language program.

Specify 000000H if no language program is included.

FS0 Operator Panel

Initial value: No FS0 machine operator's panel (check off)

Specify whether the FS0 machine operator's panel is available. If you select this item, specify the actual DI/DO address connected to the machine operator's panel, the address of a KEY image transferred from the operator's panel, and the address of an LED image to be transferred to the operator's panel.

Key Address

Setting range: X0 to X127 and X1000 to X1019

Set the PMC address corresponding to the start address of the external DI that is connected.

LED Address

Setting range: Y0 to Y127 and Y1000 to Y1014

Set the PMC address corresponding to the start address of the external DO that is connected.

Key Bit Image Address

Set the PMC address corresponding to the start address of KEY image to be referenced by a user program.

Usually, specify an arbitrary internal relay area.

LED Bit Image Address

Set the PMC address corresponding to the start address of LED image to be referenced by a user program.

Usually, specify an arbitrary internal relay area.

Channel 1 Enable

Specify whether to enable or disable the selectable I/O link assignment function for channel 1. If checking this box, specify Basic Group Count.

Channel 2 Enable

Specify whether to enable or disable the selectable I/O link assignment function for channel 2. If checking this box, specify Basic Group Count.

Basic Group Count

This parameter is used to divide I/O link assignment data into a basic group section and a parameter selection group. Set the number of basic groups. The valid number is 0 to 16.

- 1-2 Set the comment set number for displayed language of CNC (For PMC model which supports the multiple comments)

In [Language for Comment] dialog-box (<Language for Comment> button on [Edit System Parameter] screen), please set the comment set number for displayed language of CNC.

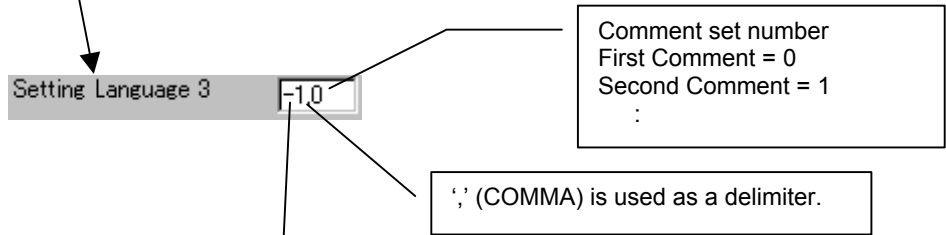
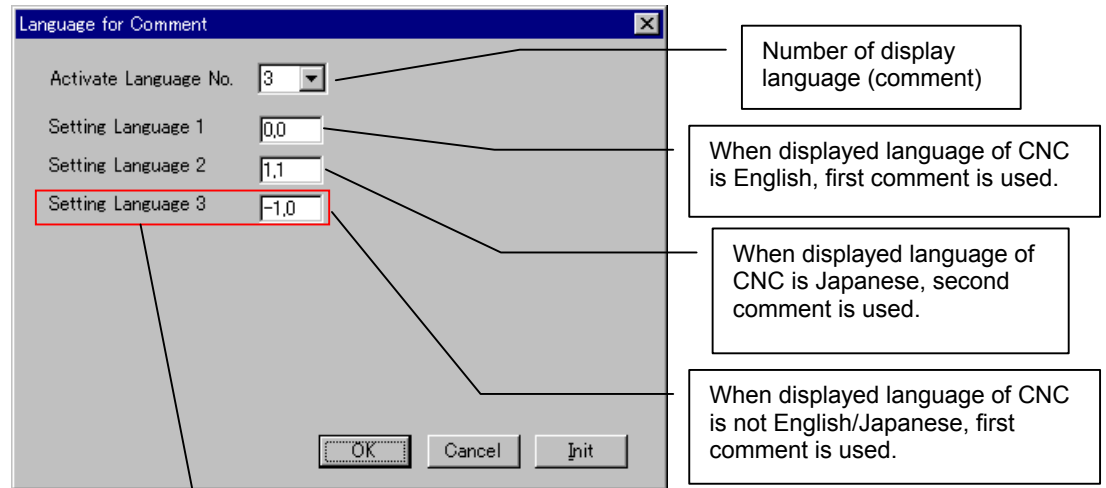

CNC display language number

0:	English	8:	Dutch
1:	Japanese	9:	Danish
2:	German	10:	Portuguese
3:	French	11:	Polish
4:	Chinese	12:	Hungarian
5:	Italian	13:	Swedish
6:	Korean	14:	Czech
7:	Spanish	-1:	Others

- 2 To close the [Edit System Parameter] screen, click the <Close> button.



<Close> button

This operation has nothing to do with whether to save the data entered on the [Edit System Parameter] screen.

See Section 3.11 "Saving Programs," for an explanation about how to save the data entered on the [Edit System Parameter] screen.

See Section 3.13 "Closing Programs," for an explanation about how to close a sequence program without saving the data entered on the [Edit System Parameter] screen.

NOTE

- 1 For details on the I/O link assignment data selection function, refer to the FANUC PMC MODEL PA1/PA3/SA1/SA2/SA3/SA5/SB/SB2/SB3/SB4/SB5/SB6/SB7/SC/SC3/SC4/NB/NB2/NB6 Ladder Language Programming Manual (B-61863E).
- 2 When channel 1 and channel 2 are not checked, the screen for setting the I/O link assignment data selection function, which is shown in Subsection 9.3.6, "Setting PMC Setting Parameters," does not appear.
- 3 To enable the I/O link assignment selection function, set the setting parameters (K910 to K930) correctly according to the I/O devices that are actually connected.

3.11 SAVING PROGRAMS

This section describes how to save new data to a sequence program (LAD file).

3.11.1 Procedure

- 1 Select [File] - [Save].
If the program has been updated, the [Program Update] screen appears.

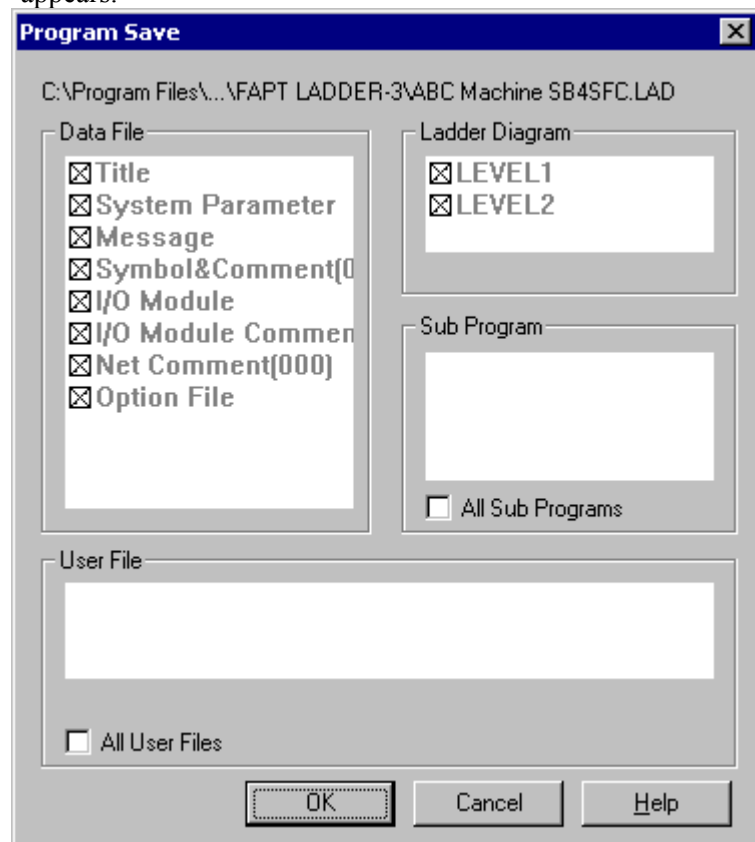

Fig. 3.11.1

- 1-1 Select the type of data that you want to update.
- 1-2 To save the program, click the <OK> button.
To quit without saving, click the <Cancel> button.

3.11.2 About the Deletion of the Unused Net Comment

As a result of operation such as "Deletion of Subprograms," net comment data that is no longer used in the source program remains in the LAD file, occupying wasted space. When the LAD file is saved, you are asked whether the unused net comment is deleted if any. It is recommended to delete unused character string data.

(When the ladder program was modified, the unused net comment is deleted automatically.)

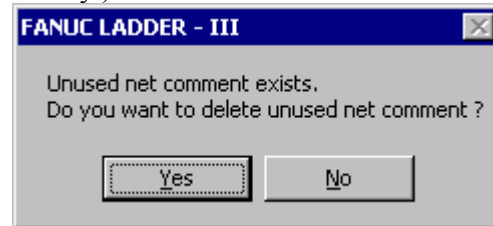

- <Yes> Delete the unused net comment.
- <No> Not modify the net comment.

NOTE

Normally, please select <Yes> button.
If you don't want to modify a net comment data and a timestamp of a LAD file, press <No> button.

3.12 SAVING PROGRAMS WITH NAMES

This section describes how to name and save a sequence program (LAD file).

3.12.1 Procedure

- 1 Select [File] - [Save As].
The [Save As] screen appears.

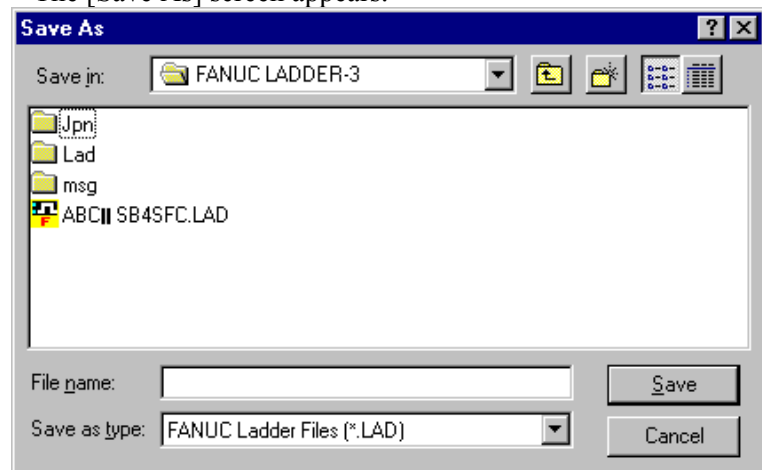

Fig. 3.12.1

- 1-1 Enter the file name you want to use.
- 1-2 To save the program, click the <OK> button.
To quit saving, click the <Cancel> button.

3.13 CLOSING PROGRAMS

This section describes how to close a sequence program (LAD file).

3.13.1 Procedure

- 1 Select [File] - [Close Program].

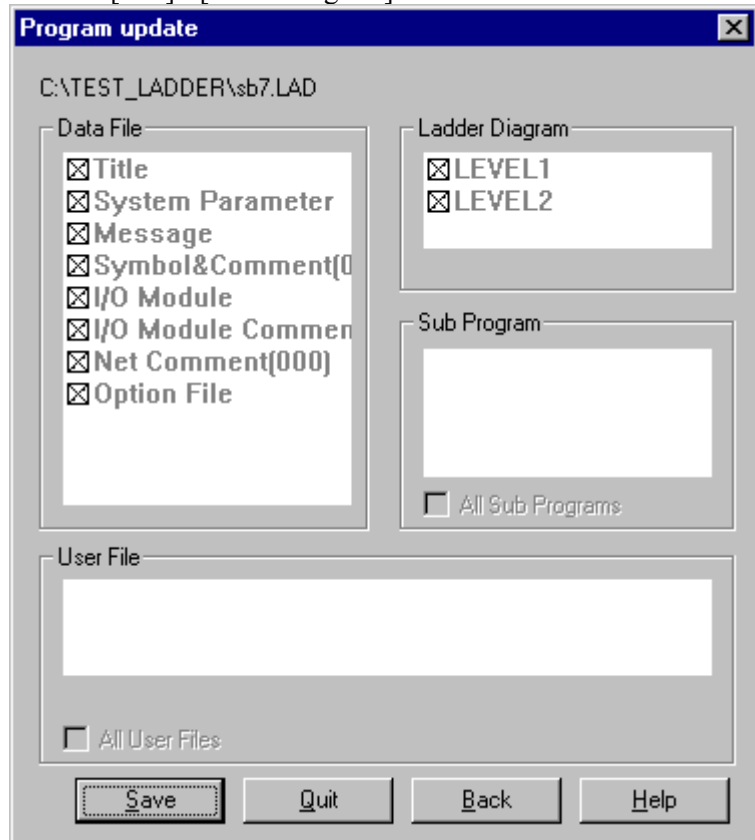

Fig. 3.13.1

- 2 The [Program Update] screen appears.
 - 2-1 Select the types of data that you want to update.
 - 2-2 To save the program, click the <Save> button. To quit saving, click the <Quit> button. To return to Program edit, click the <Back> button.

3.14 IMPORTING PROGRAMS

This section describes how to import (copy in overwrite mode) data files, ladder diagrams, and subprograms from a LAD program to another sequence program that is currently open. It also explains how to import (convert and copy in overwrite mode) files on a memory card, ROM, or Handy file format to a currently open sequence program file in memory card format.

3.14.1 Procedure

- 1 Select [File] - [Open Program] to open the program to which you want to import.
- 2 Select [File] - [Import].
The [Import/Export -- Select import file type] screen appears.

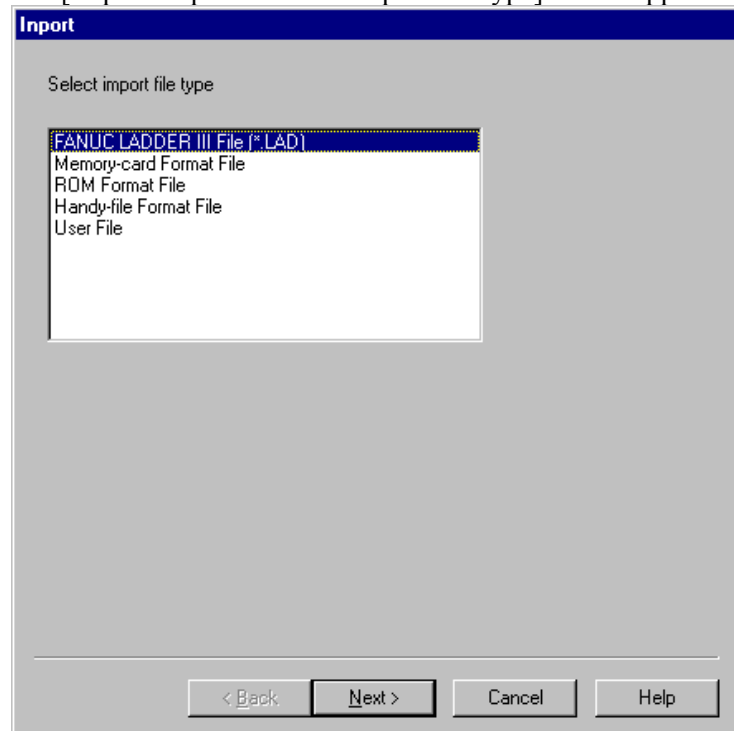

Fig. 3.14.1 (a)

- 2-1 Select the files you want to import.

FANUC LADDER-III File (*.LAD)

A data file is imported from a sequence program (LAD file) for the same PMC model.

Memory-card Format File

A memory card format file is imported. It is written over a memory card file (MCARD) for the currently open sequence program.

ROM Format File

A ROM format file is imported. It is written over a memory card file (MCARD) for the currently open sequence program.

Handy-file Format File

A Handy file format file is imported. It is written over a memory card file (MCARD) for the currently open sequence program.

User File

An arbitrary user file is imported to the user file folder (MyFladder) for the currently open sequence program. See Subsection 3.1.3, "Work Folders and Online Program Files," for an explanation about the user file folder.

NOTE

As to the import folder, you can choose the default of the import folder by the Specify the same folder as a LAD file for working directory in the [General] tab of the option.(select the [Tool] - [Option...])

Checked.....The same folder as the LAD file.
(Initial value) It is useful when saving at the same folder as the LAD file.

Not checked...The folder stored previously.
It is useful when saving to a specified folder each time.

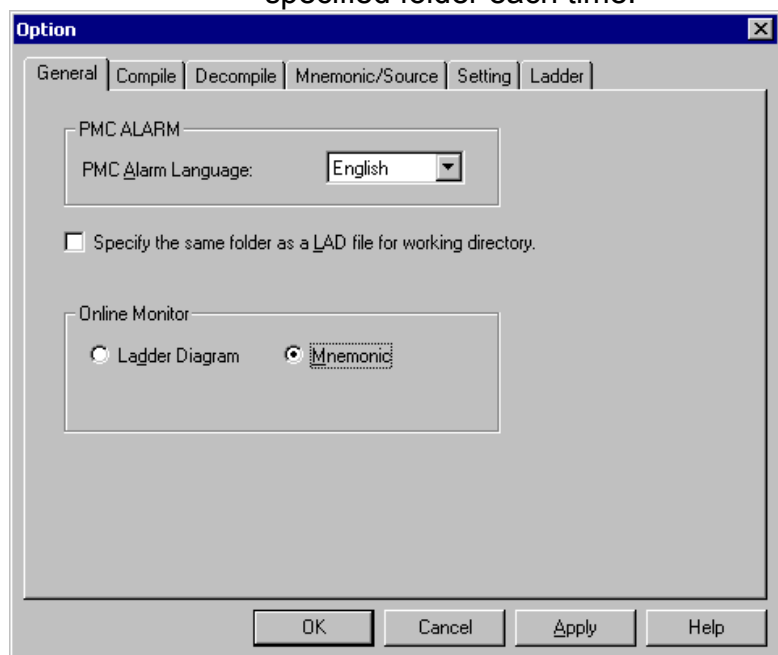

- 3 Click the <Next> button.
The [Import/Export -- Specify import file name] screen appears.

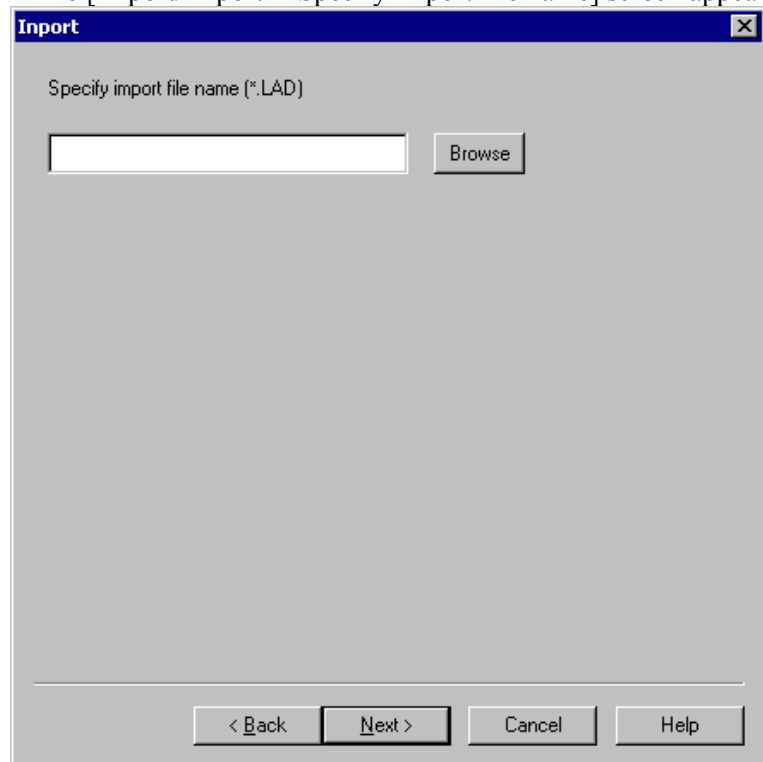

Fig. 3.14.1 (b)

- 3-1 Specify the file you want to import.

- ◆ If the FANUC LADDER-III file (*.LAD) is selected as an import-from file in step 2, above
- 4 Click the <Next> button.
The [Import/Export --Select Data File, Ladder Diagram, Subprogram, and/or User File] screen appears.

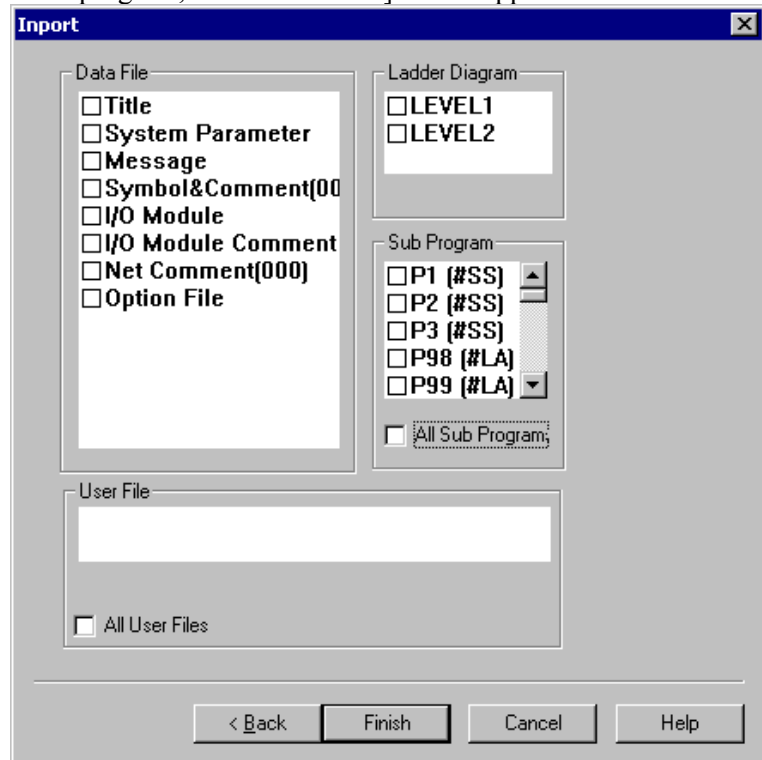

Fig. 3.14.1 (c)

- 4-1 Select the types of files you want to import.
- 5 Click the <Finish> button.
The message "Edit folder data file will be replaced/Added, Are you sure?" appears.

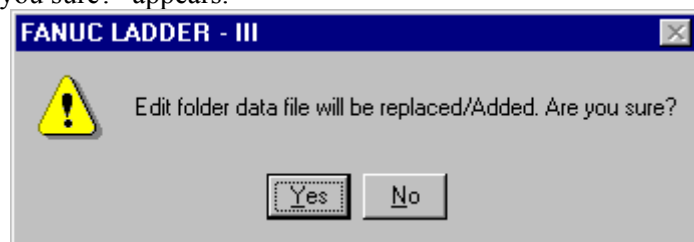

Fig. 3.14.1 (d)

To import, click the <Yes> button.

To return to the [Import/Export -- Select Data File, Ladder Diagram, Subprogram, and/or User File] screen without continuing, click the <No> button.

- 6 To quit importing, click the <Cancel> button on the [Import/Export File--Select Data File, Ladder Diagram, Subprogram, and/or User File] screen.

- ◆ If the memory format file, ROM format file, and/or Handy file format files are selected as the types of files you want to import in step 2, above
- 4 Click the <Finish> button.
The message “Import completed” appears.

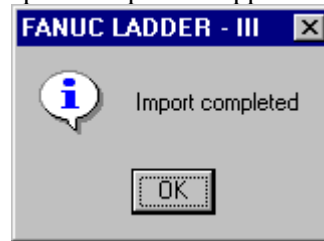

Fig. 3.14.1 (e)

Click the <OK> button.
The message “Decompile” appears.

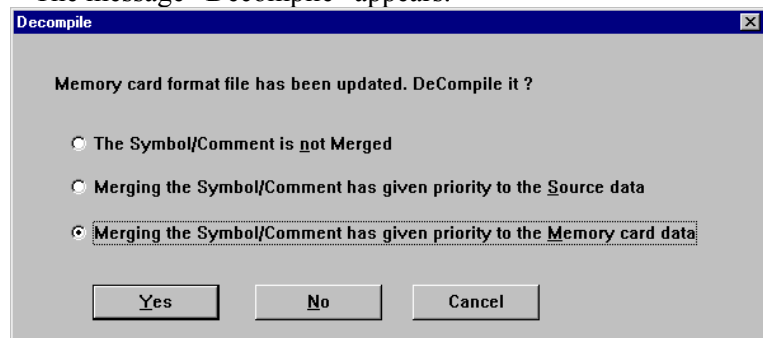

Fig. 3.14.1 (f)

If you do not want to decompile, click the <No> button.
To decompile, click the <Yes> button. The [Decompile] screen appears.

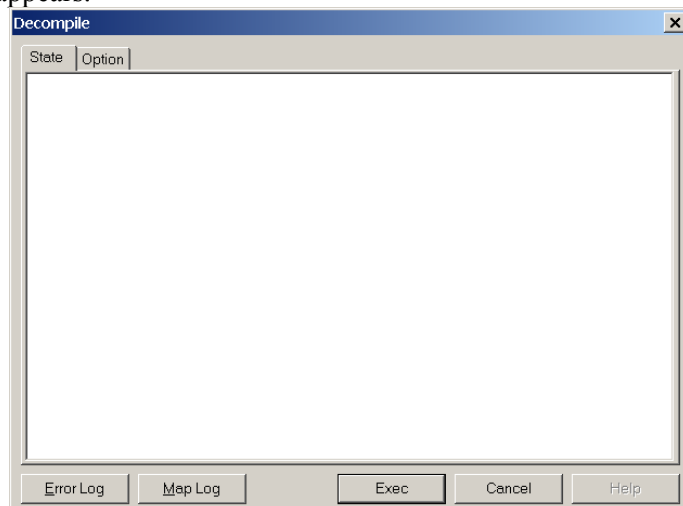

Fig. 3.14.1 (g)

- ◆ If a user file is selected as the type of file you want to import in step 2, above
- 4 Click the <Finish> button.

- ◆ If the memory card format file is selected as the type of file you want to import in step 2 above and the PMC type of the specified memory card format file is not compatible with the import destination program, a message appears, which indicates that a new import destination program will be created.

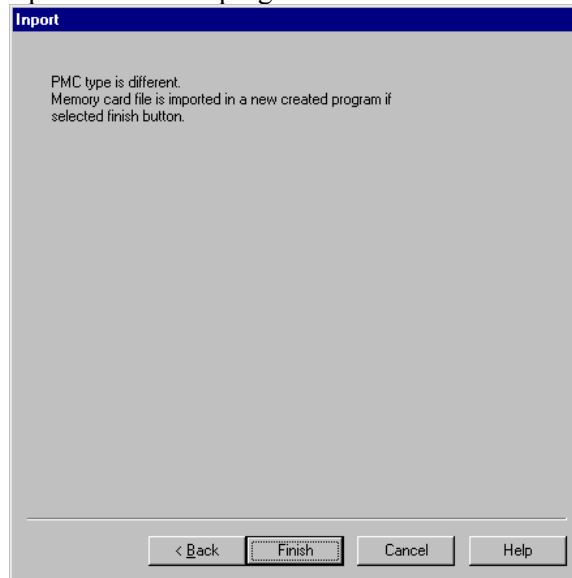

Fig. 3.14.1 (h)

The [New Program] dialog box appears. Select from among the displayed PMC types compatible with the import source memory card format file.

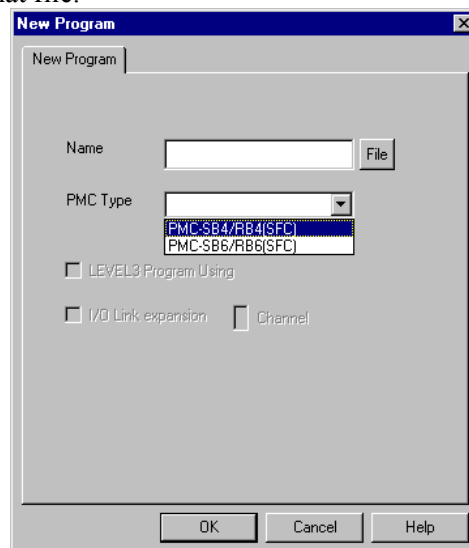

Fig. 3.14.1 (i)

The file is imported and decompiled.

NOTE

When you can select from among multiple compatible PMC types, decompilation may not terminate normally, depending on the PMC type you specify. In this case, specify another compatible PMC type.

3.14.2 Import of the External Symbol File

This function inputs the symbol/comment of external symbol file format. External symbol files are composed of identification code and the comma separated text file. You can read symbol information from the file made by the external application such as Microsoft Excel, Text editor, and electric CAD system etc.

Supported PMC models

Supported	30i/31i/32i-A Extended function 30i/31i/32i-A
------------------	--

Operation

1. Select [File]-[Import...]. Then, the [Import] dialog appears.

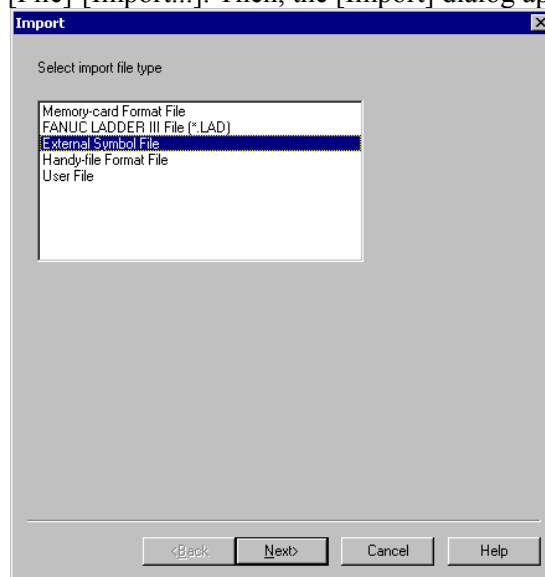

Fig. 3.14.2(a) Import dialog

2. Select **External Symbol File** from the list, push the <Next> button.
3. Enter the file name to import.

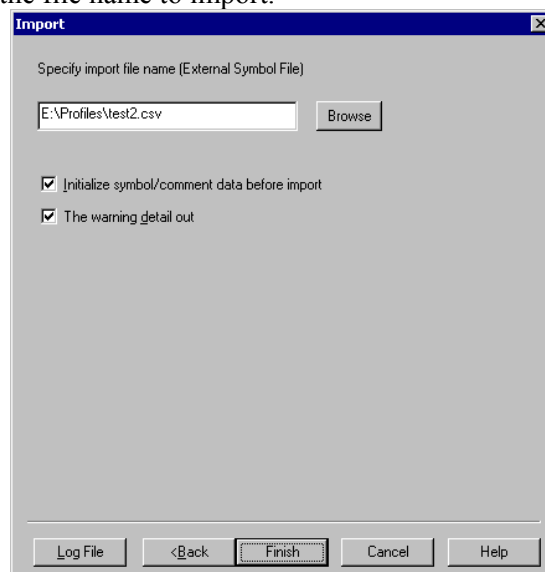

Fig. 3.14.2(b)

4. Check the following item if necessary.

<p>Initialize symbol/comment data before import</p>	<p>Checked(Default) : Checked(Default) : After clearing all symbol comment data, the symbol comment of the external symbol file is read. Not checked : Not checked : The symbol comment data of the external symbol file is added.</p>
<p>The warning detail out</p>	<p>Checked(Default) : Checked(Default) : If warning occurs during the import, the message of warning will be written to the log file. Not checked : Not checked : If warning occurs during the import, the message and the count of warning will be written to the log file. Target warning numbers : Target warning numbers : K:W-4131, K:W-4133, K:W-4138, K:W-4139</p>

5. Push the <Finish> button.

Execution result

Example of Log file.

```
##### Conversion of External Symbol File #####
      Conversion completed   Error count = 00000   Warning count = 00000
##### SYMBOL & COMMENT #####
      Conversion completed   Error count = 00000   Warning count = 00000
```

Fig. 3.14.2(c)

NOTE

- 1 The log file will be opened if the import is finished.
- 2 When the symbol has already existed, the symbol does not read.
- 3 When the character in a symbol is replaced to the white-space character, please check the following setting.
 - a. Select the [Tool]-[Option].
 - b. Click the [mnemonic/source] tag in the Option screen.
 - c. Remove the check of Converting to source programs.
- 4 Refer to "Appendix E The data format of the external symbol file" for the data format of the external symbol file.

3.15 EXPORTING PROGRAMS

This section describes how to export (copy in overwrite mode) data files, ladder diagrams, and subprograms from the currently open sequence program to another LAD program. It also explains how to export (convert and copy in overwrite mode) the currently open sequence program memory card format file to files on a memory card, in ROM, and/or Handy file format.

3.15.1 Procedure

1. Select [File] - [Open Program] to open the program from which you want to perform export.
2. Select [File] - [Export]. The following dialog appears.

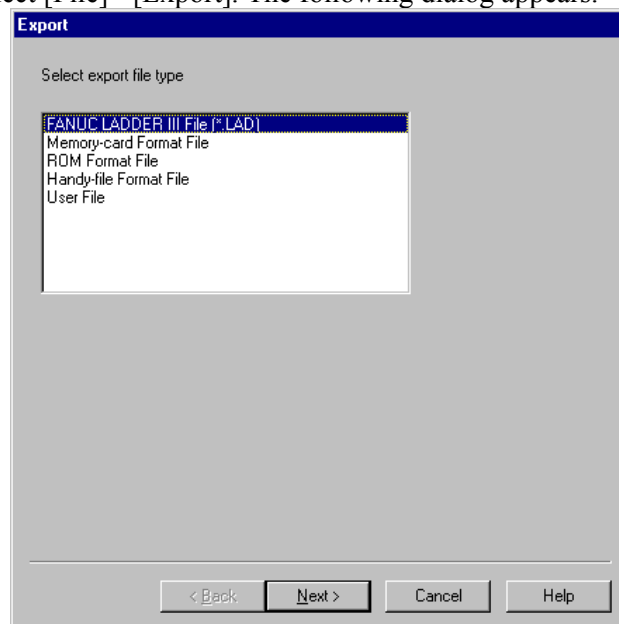

Fig. 3.15.1 (a)

- 2-1 Select the types of files you want to export.

FANUC LADDER-III File (*.LAD)

A data file is exported to a sequence program (LAD file) for the same PMC.

Memory-card Format File

A memory card file (MCARD) is exported from the currently open sequence program to a file in memory card format.

ROM Format File

A memory card file (MCARD) is exported from the currently open sequence program to a file in ROM format.

3. CREATING AND EDITING SEQUENCE PROGRAMS

Handy-file Format File

A memory card file (MCARD) is exported from the currently open sequence program to a file in Handy file format.

User File

A user file is exported from the user file folder (MyFladder) for the currently open sequence program. See Subsection 3.1.3 "Work Folders and Online Program Files," for explanations about the user file folder.

NOTE
 There is an inquiry of compilation when the Memory-card File/ROM Format File/Handy-file Format File is exported with only the source program updated.
 Please compile if necessary.

3. Click the <Next> button. The [Import/Export -- Specify export file name] dialog appears.

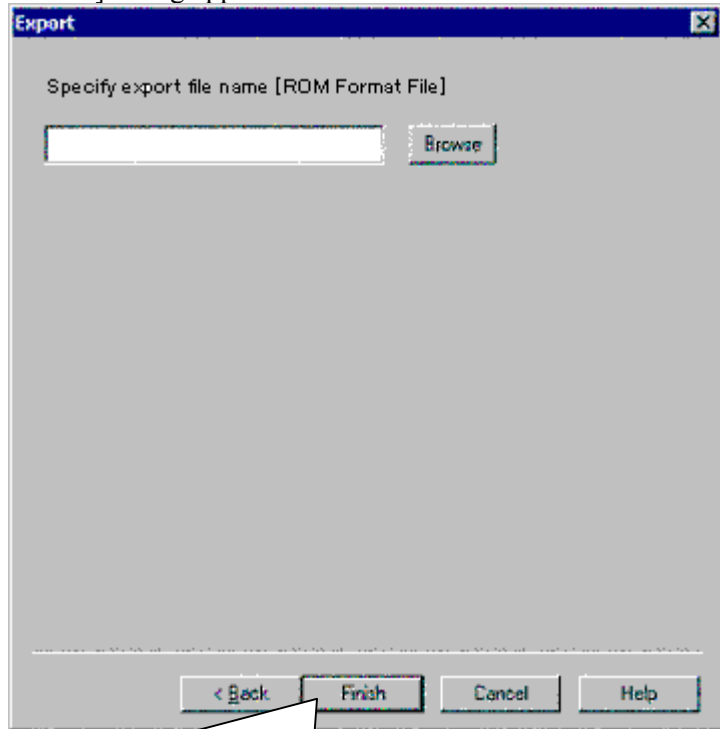

Memory-card / ROM Format / Handy-file Format

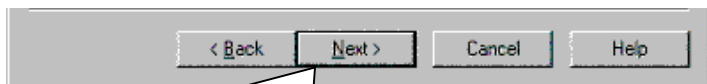

FANUC LADDER-III(*.LAD) File / User File

Fig. 3.15.1 (b)

NOTE

As to the storing folder of the text file, you can choose the default of the storing folder by the **Specify the same folder as a LAD file for working directory** in the [General] tab of the option.(select the [Tool] - [Option...])

Checked.....The same folder as the LAD file.
(Initial value) It is useful when saving at the same folder as the LAD file.

Not checked...The folder stored previously.
It is useful when saving to a specified folder each time.

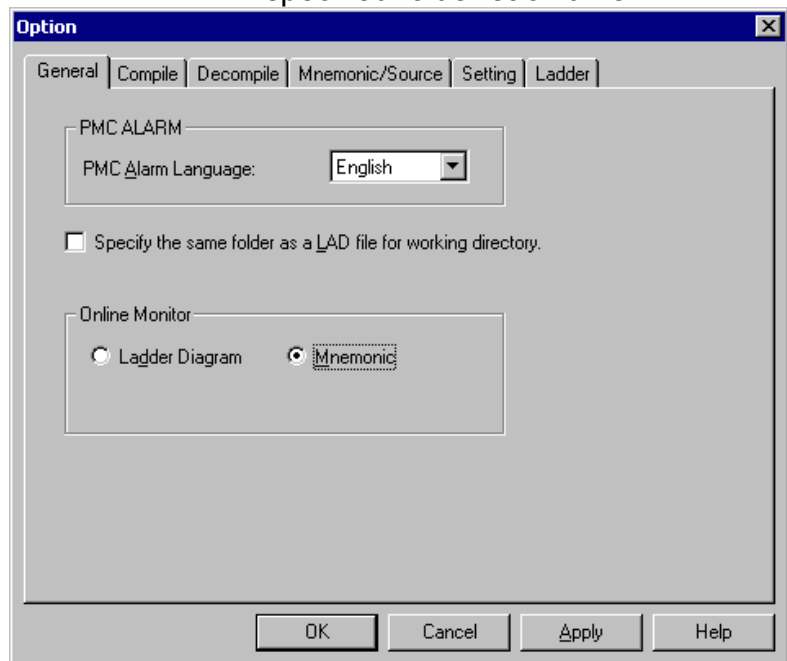

- 3-1 Directly enter the storing file name or select the file name with the [Browse] button.
If the storing file is a user file, specify the storing folder.
- 3-2 In case of FANUC LADDER-III file (*.LAD) or User File, please push <Next> button. In the other case, go to step 4.

3-3 Select the export file in the following dialog.

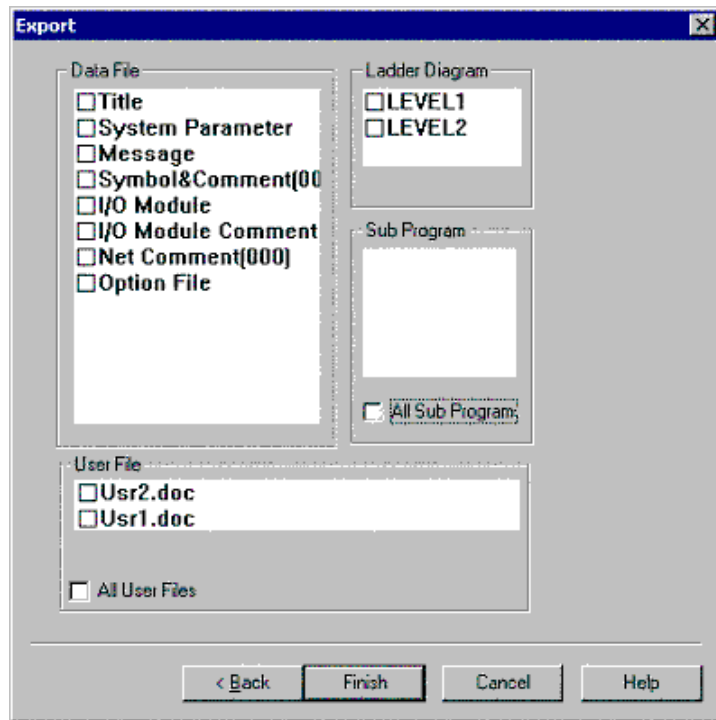

Fig. 3.15.1 (c)

NOTE

In the export of User File, only user files can be selected.

4. Click the <Finish> button.

- Memory-card / ROM Format / Handy-file Format

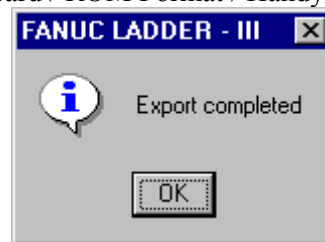

Fig. 3.15.1 (d)

NOTE

If a file with the same name is already present in the export destination folder, an overwrite confirmation message appears.

- FANUC LADDER-III(*.LAD)

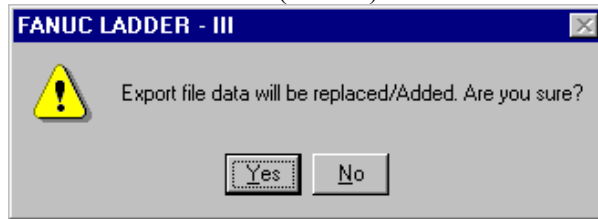

Fig. 3.15.1 (e)

To export, click the <Yes> button. To return to the [Import/Export -- Select Data File, Ladder Diagram, Subprogram, and/or User File] screen without continuing, click the <No> button.

- User File

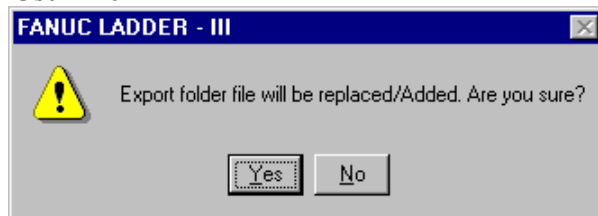

Fig. 3.15.1 (f)

To export, click the <Yes> button. To quit exporting, click the <No> button.

3.15.2 Export of the External Symbol File

This function outputs the symbol/comment of external symbol file format. External symbol files are composed of identification code and the comma separated text file. You can edit the symbol/comment data by the external application such as Microsoft Excel, Text editor.

Supported PMC models

Supported	30i/31i/32i-A Extended function 30i/31i/32i-A
------------------	--

Operation

1. Select [File]-[Export...]. Then, the [Export] dialog appears.

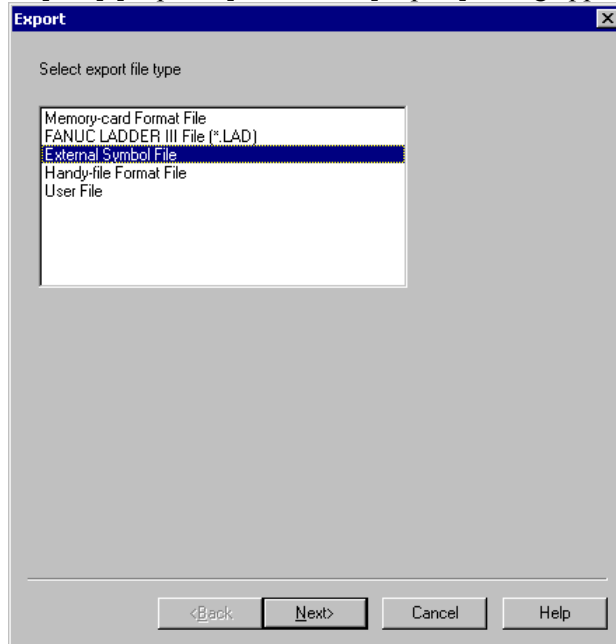

Fig. 3.15.2(a) Export dialog

2. Select **External Symbol File** from the list, push the <Next> button.
3. Enter the file name to export.

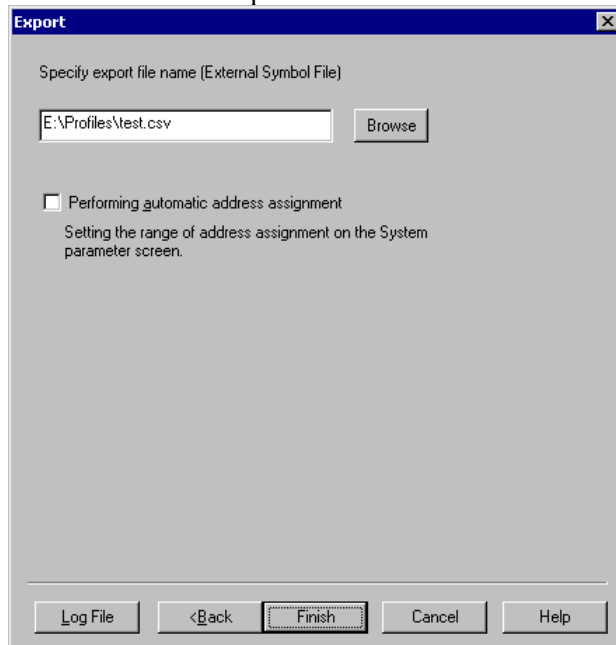

Fig. 3.15.2(b)

4. Check **Performing automatic address assignment** if needed.
 This item appears when the PMC model is the extended function.
 Check this item if you use the external symbol file at the non-extended function.
 Check : The address of the symbol is assigned automatically and outputted in the external symbol file. Beforehand, you need to specify the assignment address range on the system parameter screen.
 No check(Default): The address is not assigned automatically and outputted with the address character only.

	Address of symbol	External symbol file	Remarks
Check	R0.3 *R1.0 R	R0.3 R1.3 R1.4	The address is assigned automatically and outputs the external symbol file.
No check	R0.3 *R1.0 R	R0.3 R R	The address assigned automatically is outputted in the address character only.

5. Click the <Finish> button.

Execution result

Example of Log file.

```
##### SYMBOL & COMMENT #####
      Conversion completed   Error count = 00000   Warning count = 00000
##### Conversion of External Symbol File #####
      Conversion completed   Error count = 00000   Warning count = 00000
```

Fig. 3.15.2(c) 30i/31i/32i-A

```
##### Assignment of address #####
      Assignment completed   Error count = 00000   Warning count = 00000
##### SYMBOL & COMMENT #####
      Conversion completed   Error count = 00000   Warning count = 00000
##### Conversion of External Symbol File #####
      Conversion completed   Error count = 00000   Warning count = 00000
```

Fig. 3.15.2(d) 30i/31i/32i-A Extended function

NOTE

- 1 When a white-space character is contained in the symbol, it can be replaced with the specified character. Select [Tool] – [Option...]. Click [Mnemonic/Source] tag. Input the character to replace in **Converting to a mnemonic file**. Default is (underbar).
- 2 L address of LABEL type is always automatically assigned regardless of this setting.
- 3 Refer to "Appendix E The data format of the external symbol file" for the data format of the external symbol file.

3.16 OPENING MOST RECENTLY USED PROGRAMS

This section describes how to open the most recently used programs (up to four).

Procedure

1. Display the [File] menu.

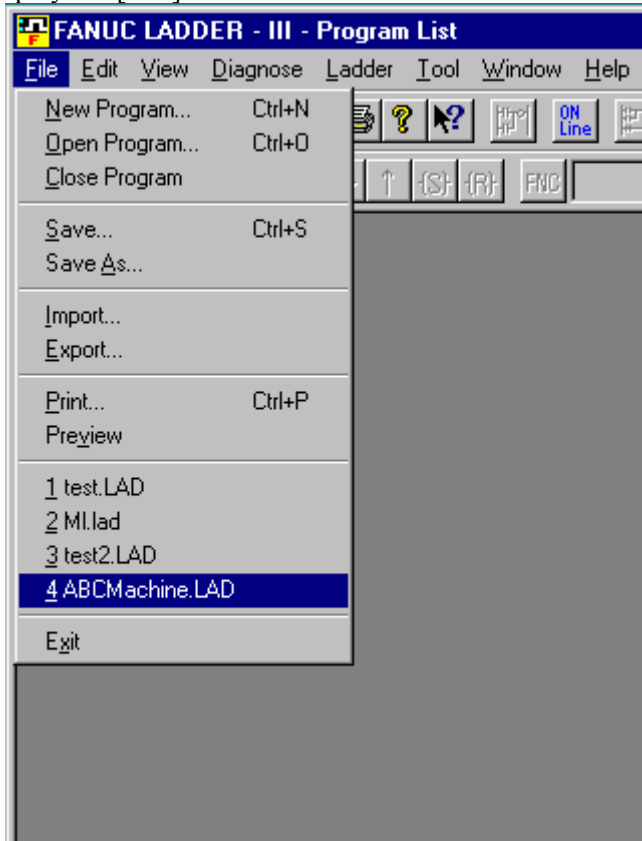

Fig. 3.16

2. Up to four most recently used programs are displayed above [Exit].
3. Select the program you want to display/edit.

3.17 CHECKING DUPLICATE COIL

This section describes how to check duplicate coil.

NOTE

- 1 When the programmer mode is only off-line, duplicate coil check is done for the source program of the ladder.
- 2 Duplicate coil check is not done for the step sequence subprogram and the ladder subprogram protected by a special password.
- 3 The net with the error while editing is excluded from the check.
- 4 Even if the source program of the ladder edits and is updated, the content of [duplicate coil] screen is not updated.
- 5 When the source program of the ladder has been updated, the ladder edit screen is not opened from [duplicate coil list] screen.
- 6 Symbol and wild-card ('*', '?') cannot be used to set the check address.

3.17.1 Duplicate Coil Screen

The information list (Address/Symbol/Net No./Instruction) of the duplicate coil is displayed.

Procedure

- 1 [Duplicate Coil – Address Setting] dialog is displayed by either of the following operations.
 - ◆ Double-click the <Duplicate Coil> item on the [Program List] screen.
(Alternatively, move cursor to <Duplicate Coil> and press [Enter] or [F10] key)
 - ◆ Right-click <Duplicate Coil> item on the [Program List] screen, and click [Check...] from context menu.
 - ◆ Right-click on the Ladder edit screen, and click [(bit address) Duplicate Coil Check] from context menu.

2. Select the check address on [Duplicate Coil – Address Setting] dialog.



Fig. 3.17.1 (a)

All

All the output addresses are checked.

Address

An arbitrary output address is checked.

Specification by the bit address and specification in the range to have used byte address are possible.

','(comma) is used to specify two or more conditions.

Example: A0.0,A0.4,R0-R100,Y0-Y15

Address kind

All the range of the selected kind of address are checked.

Please select the kind of address on [Duplicate Coil - Address Kind Setting] dialog

(Press <Select> button to display [Duplicate Coil - Address Kind Setting] dialog.)

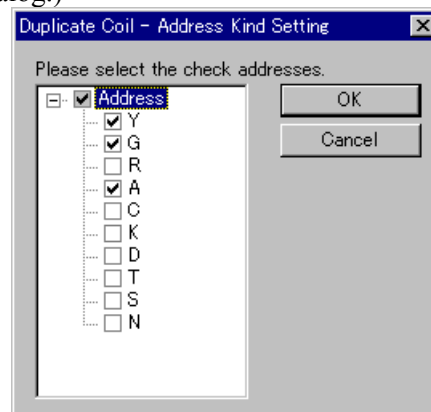

Fig. 3.17.1 (b)

- To start Duplicate Coil Check, click <OK> button on [Duplicate Coil – Address Setting] dialog box. The following dialog is displayed while checking duplicate coil. (Please click <Cancel> button to abort duplicate coil check.)

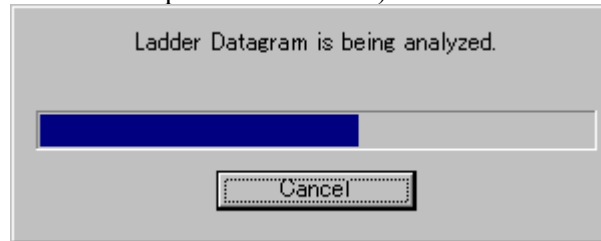

Fig. 3.17.1 (c)

- When the check is completed, [Duplicate Coil] screen is displayed.

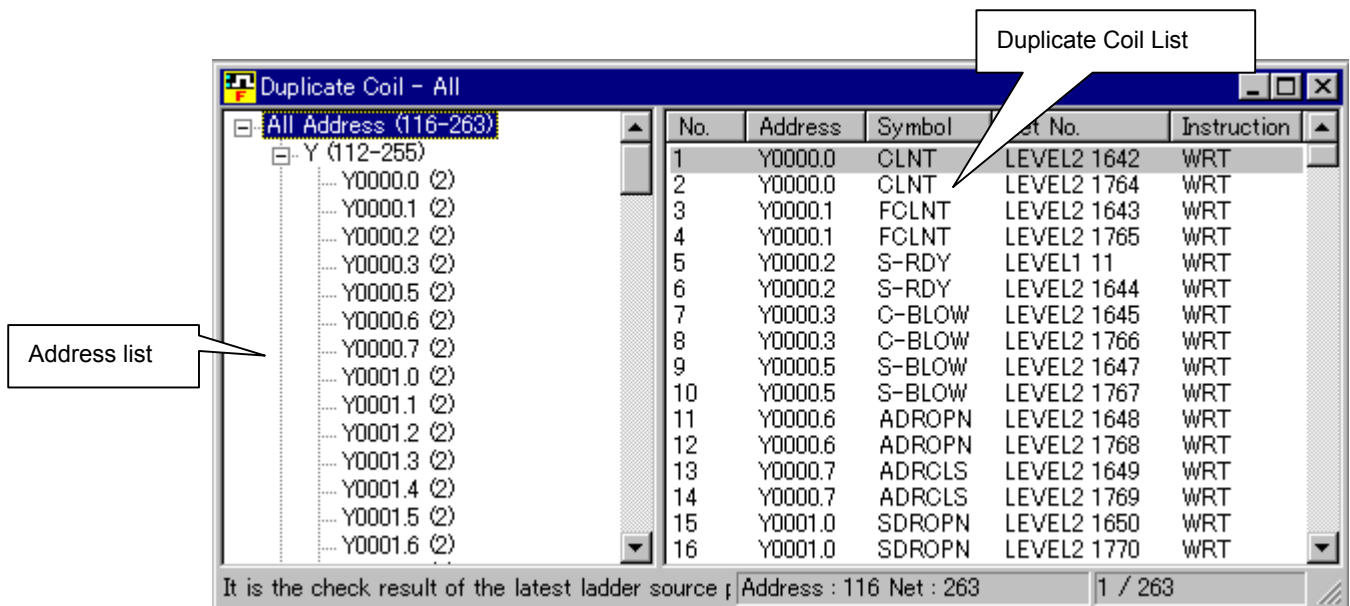

Fig. 3.17.1 (d)

Address List

Address of duplicate coil is displayed by the tree form
 The number of nets is displayed in parentheses. (In All Address and kind of address, the number of addresses and nets is displayed.)

Duplicate coil list

The information list (Address/Symbol/Net No./Instruction) of the duplicate coil is displayed.
 The ladder edit screen of the address on the cursor line can be easily displayed (double-clicking or <F10> key).
 Moreover, the content of the display can be output to the text file by selecting [Output a text format file...] in TOOL menu.

Soft Keys



Fig. 3.17.1 (e)

F4 **S**etting...
 [Duplicate Coil – Address Setting] dialog box is displayed.

F5 **P**roperties...
 Address property dialog box of cursor line is displayed.



Fig. 3.17.1 (f)

F9 **U**ppdate
 When the source program of the ladder is updated, duplicate coil check is restarted.

F10 **L**adder Open
 The ladder edit screen of address on the cursor line displayed.

Context menu

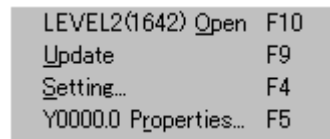

Fig. 3.17.1 (g)

3.18 PMC TYPE CHANGED AND SAVE

You can convert the PMC model easily by saving the opened program after changing the PMC type to the specified one.

Procedure

1. Select [File]-[PMC Type changed and save]. The [PMC Type changed and save] dialog appears.

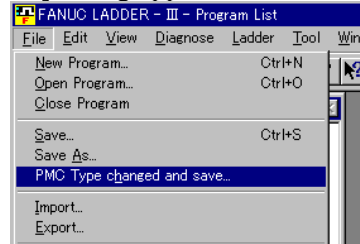

Fig. 3.18(a)

2. Enter the program name and the PMC type which wants to change.
3. Click the <OK> button.

The following dialogs are displayed when a memory card format data newer than the source program exists.

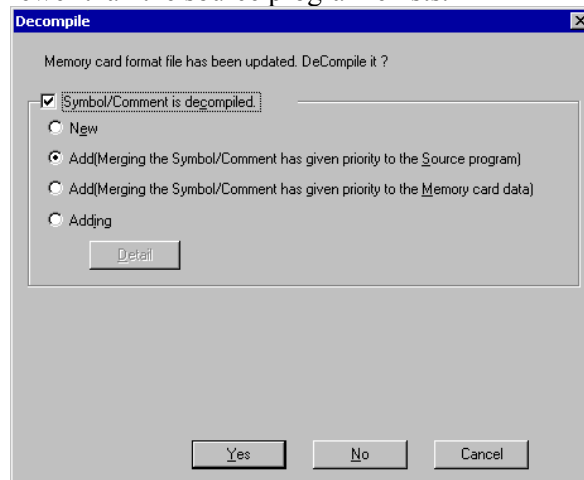

Fig. 3.18(b)

Table 3.18(a)

Item	Explanation
Symbol/Comment is decompiled	If not checked, no symbol/comment data is decompiled. The definition of the source is directly used.
New	The definition of the source program is newly made from the symbol and comment of object code.
Add(Merging the Symbol/ Comment has given priority to the Source data)	The symbols of the source program and object code are merged only for a symbol and comment. If the same symbol and comment exist, the definition of the source program is used.

3.CREATING AND EDITING SEQUENCE PROGRAMS

Table 3.18(a)

Item	Explanation
Add(Merging the Symbol/Comment has given priority to the Memory card data)	The symbols of the source program and object code are merged only for a symbol and comment. If the same symbol and comment exist, the definition of the object code is used.
Adding	The symbols of the source program and object code are merged only for a symbol and comment. If the same symbol and comment exist, the using definition can be separately selected for symbol, first comment or second comment. Please push <Detail> button and select the using definition on [Detail] dialog box.
<Yes>	Click the <Yes> button to start DeCompile.
<No>	Click the <No> button to cancel DeCompile.
<Cancel>	Click the <Cancel> button to quit this function.

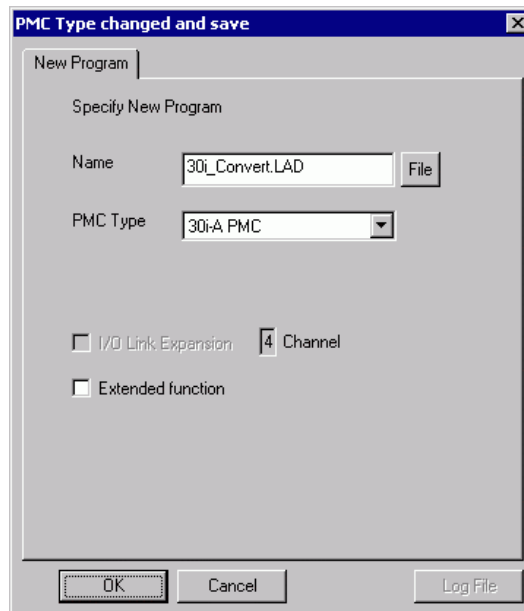

Fig. 3.18(c)

Table 3.18(a)

Item	Explanation
Name	Enter the new name of a program file you want to create.
PMC Type	Select a PMC type to change.
I/O Link Expansion	Check this check box to enable the I/O Link expansion function after selecting a model that allows multiple channels to be set. (This item is effective when the PMC type that can use the multiple channels is selected.)
Extended function	In case of using the extended Symbol/Comment function, check this check box. (This item is effective when the PMC type that can use the extended function is selected.)

NOTE

- 1 When you change Ladder program into other PMC type, please decide an address first. The PMC type cannot be changed when the address is not decided.
- 2 In the following cases, a ladder is not converted.
 - The address out of range on the target PMC type is used in the ladder.
 - The non-supported functional instruction on the target PMC type is used.
 - The message address out of range on the target PMC type is used.
 - The channel out of range and the non-supported allocation name on the target PMC type are used.

See Section “13.2.10 Mnemonic Conversion Error Message” for details.

4

PRINTING SEQUENCE PROGRAMS

This chapter describes how to print a sequence program, which consists of a title, system parameters, symbols, comments, I/O modules, messages, ladders and step sequences.

4.1 PRINTING TITLES

This section describes how to print title data.

4.1.1 Procedure

1. Select [File] - [Print]. The [Print] screen appears.

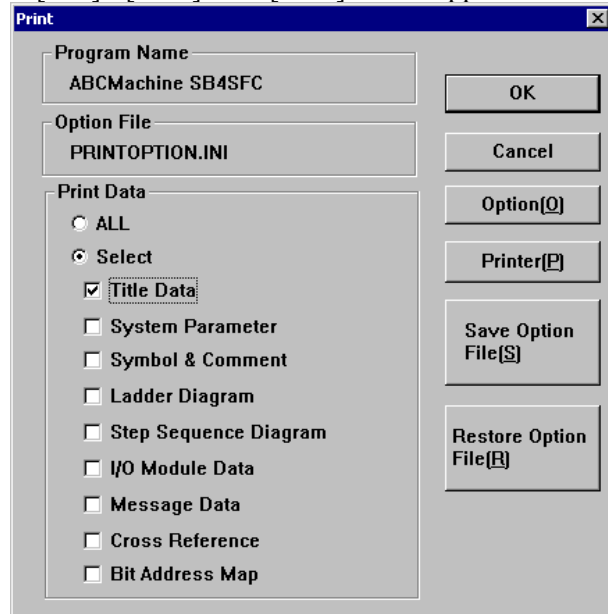

Fig. 4.1.1 (a)

- 1-1 Select Title Data from Print Data.

1-2 Click the <Option> button. The [Option] screen appears.

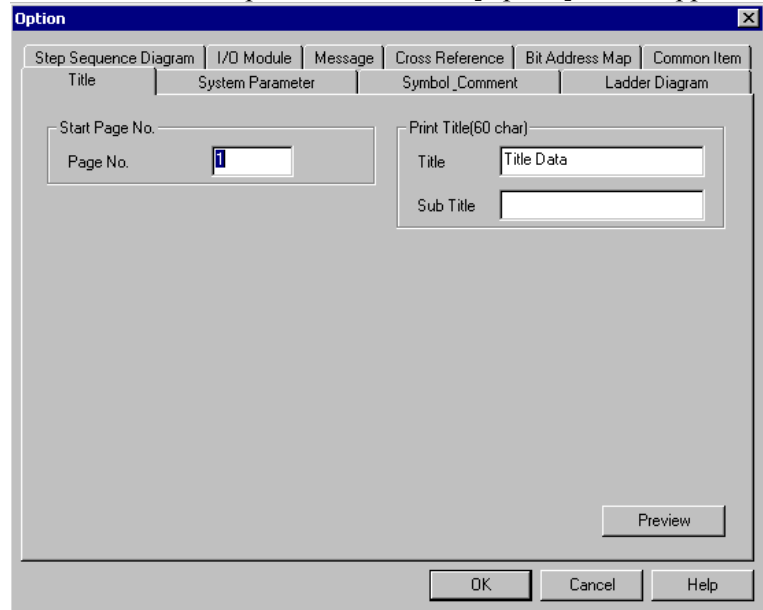

Fig. 4.1.1 (b)

2. Set the following print options on the Title tab.
 - Page No.**
Specify a start page number for title printing (the Initially value is 1).
 - Title**
Specify a title to be printed (the Initially value is "Title Data").
 - Sub Title**
Specify a subtitle to be printed (the Initially value is blank).
3. To preview title printing, click the <Preview> button.
4. To set up the print options, click the <OK> button.
To cancel the setup of the print options, click the <Cancel> button.
The [Print] screen appears again.
5. To print, click the <OK> button.
To quit without printing, click the <Cancel> button.

4.2 PRINTING LADDER DIAGRAMS

This section describes how to print ladder diagrams.

4.2.1 Procedure

1. Select [File] - [Print]. The [Print] screen appears.

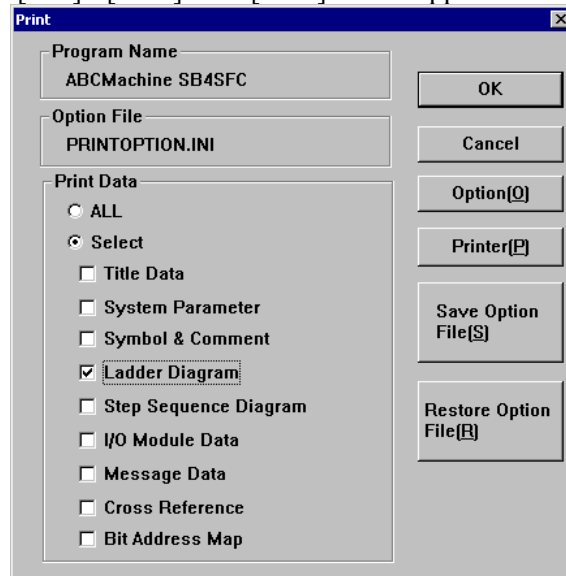

Fig. 4.2.1 (a)

- 1-1 Select Ladder Diagram from **Print Data**.

- 1-2 Click the <Option> button. The [Option] screen appears.

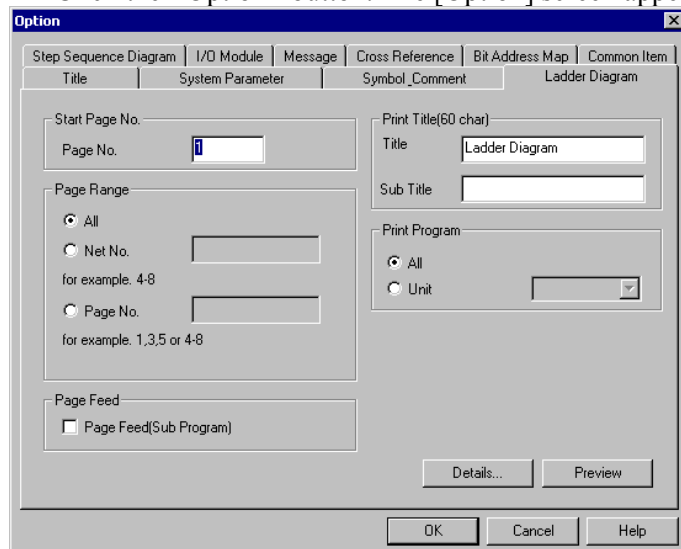

Fig. 4.2.1 (b)

2. Set up the following print options on the Ladder Diagram tab.

Page No.

Specify a start page number for ladder diagram printing (the Initially value is 1).

Title

Specify a title for ladder diagram printing (the Initially value is "Ladder Diagram").

Sub Title

Specify a subtitle for ladder diagram printing (the Initially value is blank).

Page Range

Specify the range of ladder diagrams to be printed (the Initially value is <All>).

All: All ladder diagrams will be printed.

Net No.: The ladder diagrams in the specified nets will be printed.

When you specify [Unit] for the print target program, specify the range of nets in the subprogram.

Page No.: The ladder diagrams on the specified pages will be printed.

Print Program

Specify the ladder programs you want to print (the Initially value is <All>).

All: All programs (including subprograms) will be printed.

Unit: Enter the name of the subprogram you want to print, or select it from the combo box.

Page Feed (Sub Program) (Initially not selected.)

3. To preview ladder diagram printing, click the <Preview> button.

4. To specify ladder diagram printing in detail, click the <Details> button.

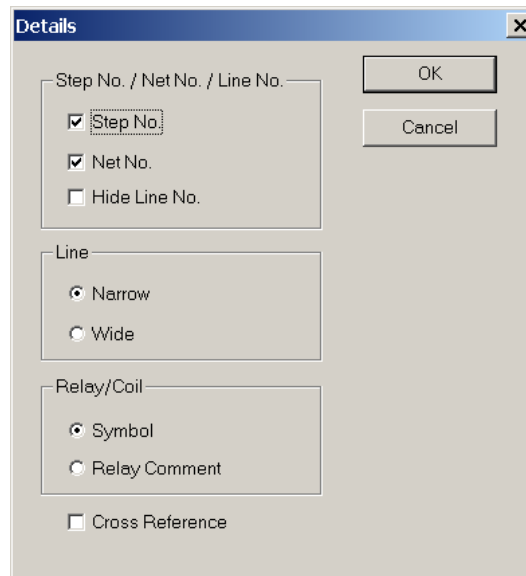

Fig. 4.2.1 (c)

Step No. (Initially selected.)

Net No. (Initially selected.)

Hide Line No. (Initially not selected.)

Line

Specify line spacing for nets (the Initially value is <Narrow>).

Relay/Coil

Specify the data to be printed at a contact (the Initially value is <Symbol>).

Symbol: Symbol data for contacts will be printed.

Relay Comment: Data for relay comments will be printed.

Cross Reference (Initially not selected.)

5. To set up the print options, click the <OK> button.
To cancel the setup of the print options, click the <Cancel> button.
The [Print] screen appears again.
6. To print, click the <OK> button.
To quit without printing, click the <Cancel> button.

4.3 PRINTING STEP SEQUENCES

This section describes how to print step sequences.

4.3.1 Procedure

1. Select [File] - [Print]. The [Print] screen appears.

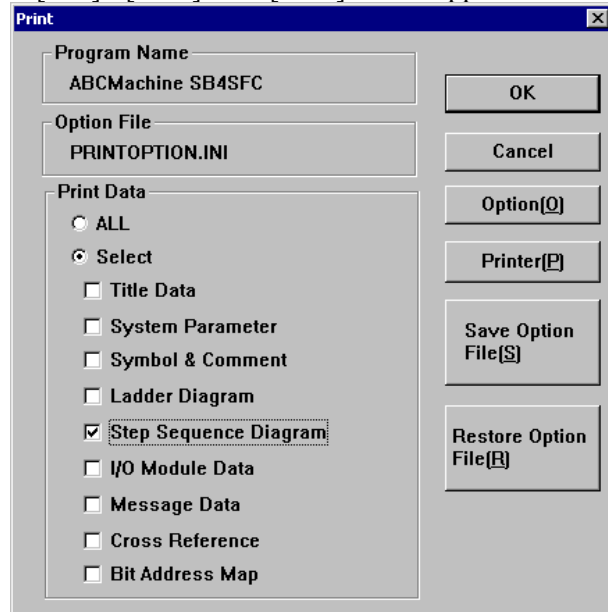

Fig. 4.3.1 (a)

- 1-1 Select Step Sequence Diagram from **Print Data**.
If the PMC model does not support step sequences, or if there is no step sequence, this item is not displayed.

- 1-2 Click the <Option> button. The [Option] screen appears.

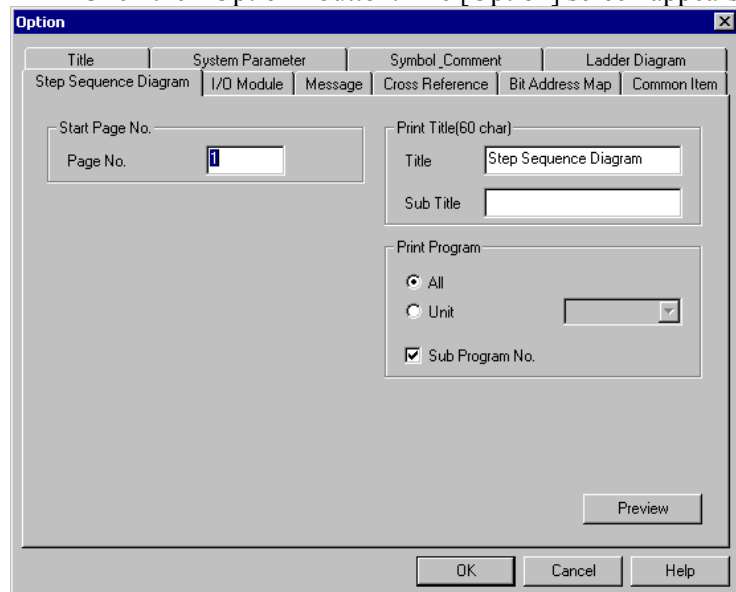

Fig. 4.3.1 (b)

2. Set up the following print options on the Step Sequence Diagram tab.

Page No.

Specify a start page number for step sequence printing (the Initially value is 1).

Title

Specify a title for step sequence printing (the Initially value is "Step Sequence Diagram").

Sub Title

Specify a subtitle for step sequence printing (the Initially value is blank).

Print Program

Specify the step sequence programs you want to print (the Initially value is <All>).

All: All programs (including subprograms) will be printed.

Unit: Enter the name of the subprogram you want to print, or select it from the combo box.

Sub Program No. (Initially selected.)

3. To preview step sequence program printing, click the <Preview> button.
4. To set up the print options, click the <OK> button.
To cancel the setup of the print options, click the <Cancel> button.
The [Print] screen appears again.
5. To print, click the <OK> button.
To quit without printing, click the <Cancel> button.

4.4 PRINTING SYMBOLS AND COMMENTS

This section describes how to print symbols and comments.

4.4.1 Procedure

1. Select [File] - [Print]. The [Print] screen appears.

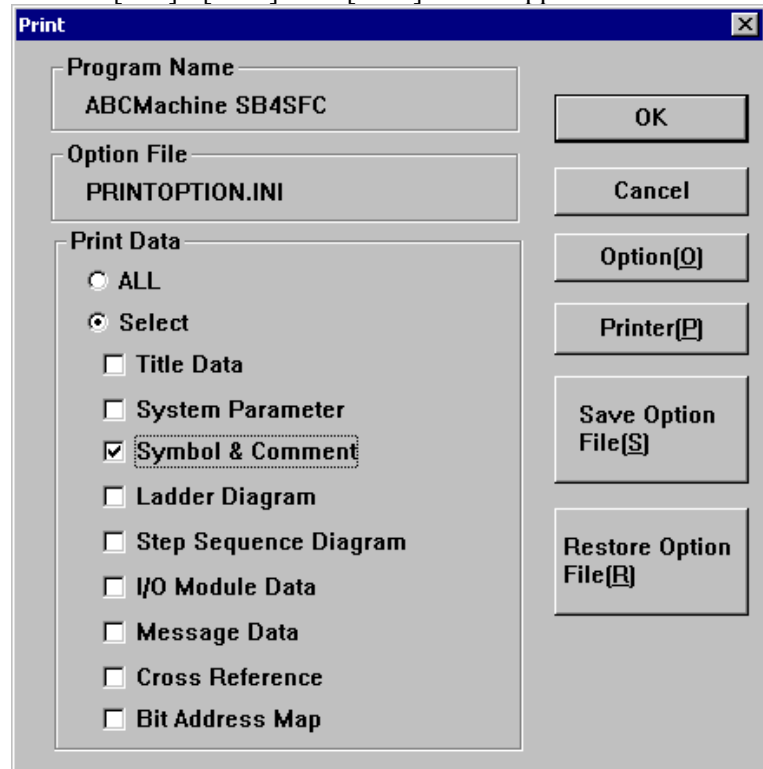

Fig. 4.4.1 (a)

- 1-1 Select Symbol & Comment from Print Data.

1-2 Click the <Option> button. The [Option] screen appears.

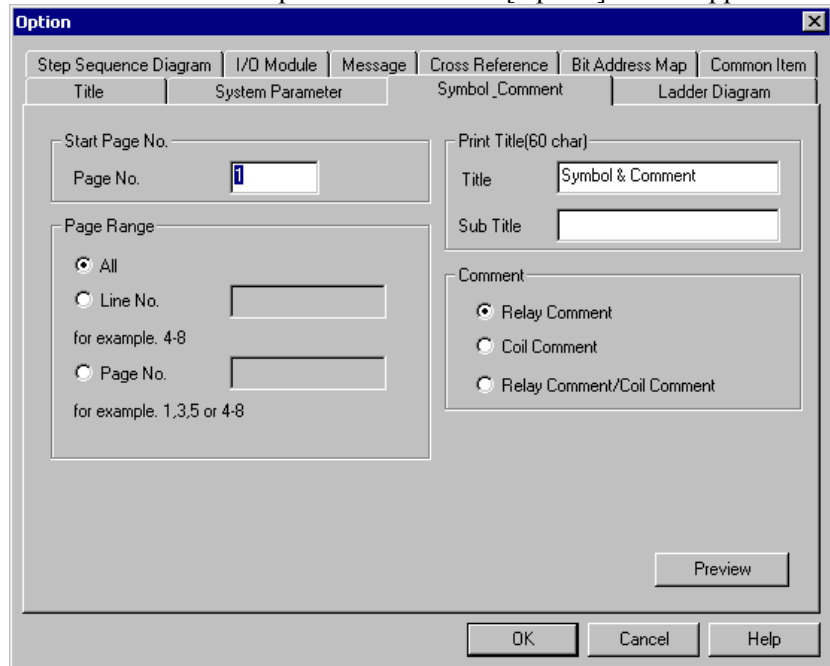

Fig. 4.4.1 (b)

2. Set up the following print options on the Symbol tab.

Page No.

Specify a start page number for symbol printing (the Initially value is 1).

Title

Specify a title for symbol printing (the Initially value is "Symbol & Comment").

Sub Title

Specify a subtitle for symbol printing (the Initially value is blank).

Page Range

Specify the range of symbols to be printed (the Initially value is <All>).

All: All the symbols will be printed.

Line No.: The symbols on the specified lines will be printed.

Page No.: The symbols on the specified pages will be printed.

Comment

Specify the type of comment you want to print (the Initially value is <Relay Comment>).

Relay Comment: A relay comment will be printed.

Coil Comment: A coil comment will be printed.

Relay Comment/Coil Comment:

Relay and coil comments will be printed.

3. To preview symbol printing, click the <Preview> button.
4. To set up the print options, click the <OK> button.
To cancel the setup of the print options, click the <Cancel> button.
The [Print] screen appears again.
5. To print, click the <OK> button.
To quit without printing, click the <Cancel> button.

4.5 PRINTING MESSAGES

This section describes how to print messages.

4.5.1 Procedure

1. Select [File] - [Print]. The [Print] screen appears.

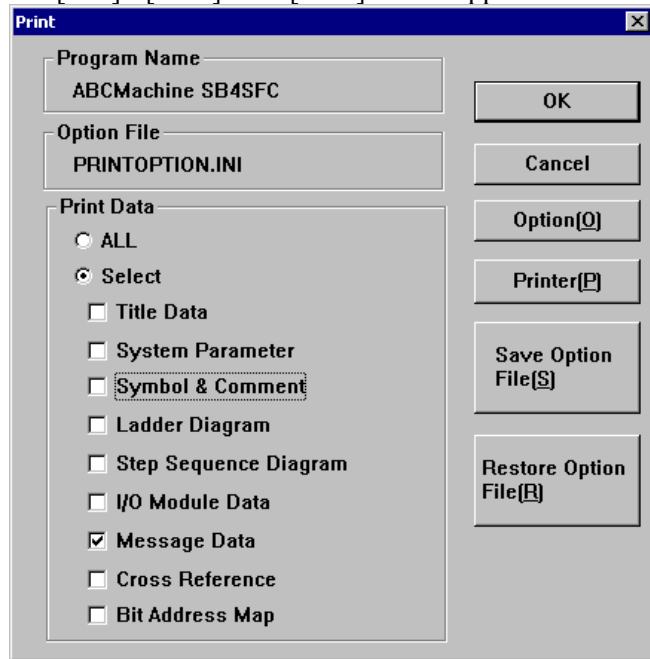

Fig. 4.5.1 (a)

- 1-1 Select Message Data from **Print Data**.

- 1-2 Click the <Option> button. The [Option] screen appears.

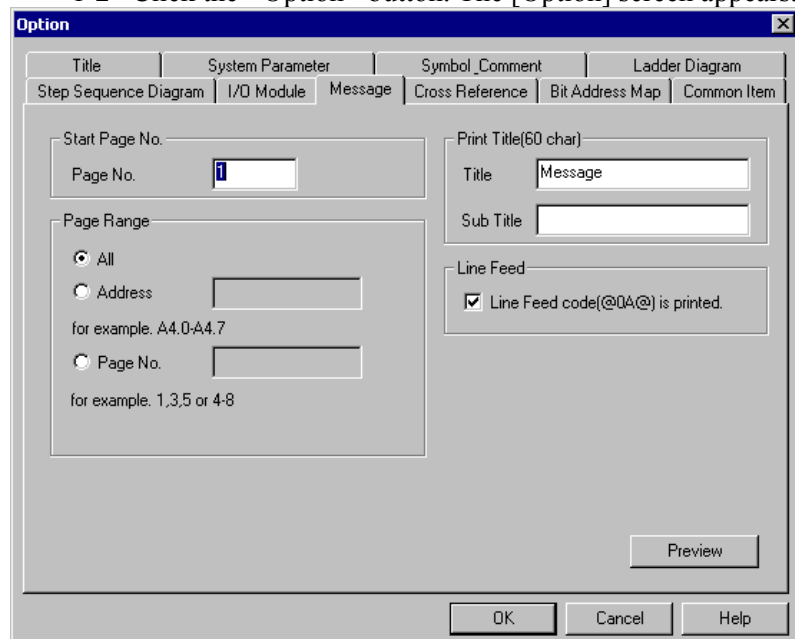

Fig. 4.5.1 (b)

2. Set up the following print options on the Message tab.

Page No.

Specify a start page number for message printing (the Initially value is 1).

Title

Specify a title for message printing (the Initially value is "Message").

Sub Title

Specify a subtitle for message printing (the Initially value is blank).

Page Range

Specify the range of messages to be printed (the Initially value is <All>).

All: All the messages will be printed.

Address: The messages in the specified address range will be printed.

Page No.: The messages on the specified pages will be printed.

Line Feed code(@0A@) is printed. (the Initially value is on).

When this option is not selected (off), message data is printed with the code (@0A@) replaced with a carriage return.

3. To preview message printing, click the <Preview> button.
4. To set up the print options, click the <OK> button.
To cancel the setup of the print options, click the <Cancel> button.
The [Print] screen appears again.
5. To print, click the <OK> button.
To quit without printing, click the <Cancel> button.

4.6 PRINTING I/O MODULE ASSIGNMENT

This section describes how to print I/O module assignments.

4.6.1 Procedure

1. Select [File] - [Print]. The [Print] screen appears.

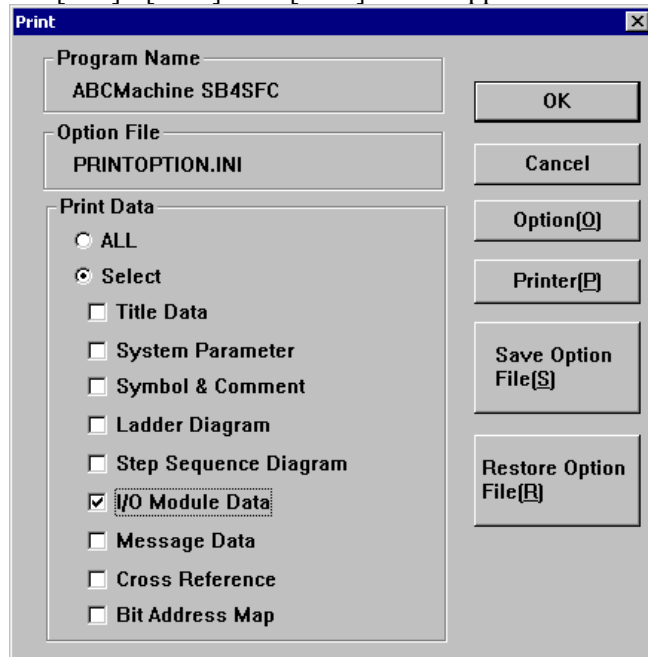

Fig. 4.6.1 (a)

- 1-1 Select I/O Module Data from **Print Data**.

- 1-2 Click the <Option> button. The [Option] screen appears.

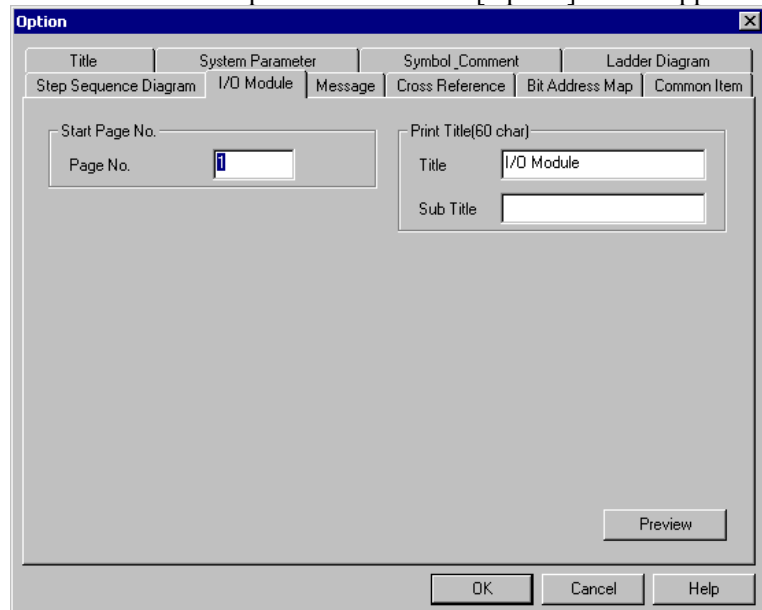

Fig. 4.6.1 (b)

2. Set up the following print options on the I/O Module tab.
 - Page No.**
Specify a start page number for I/O module printing (the Initially value is 1).

 - Title**
Specify a title for I/O module printing (the Initially value is "I/O Module").

 - Sub Title**
Specify a subtitle for I/O module printing (the Initially value is blank).

 - 1 Channel** (Initially selected.)
(This item is to be set if the PMC model is PMC-QC.)

 - 2 Channel** (Initially selected.)
(This item is to be set if the PMC model is PMC-QC.)
3. To preview I/O module printing, click the <Preview> button.
4. To set up the print options, click the <OK> button.
To cancel the setup of the print options, click the <Cancel> button.
The [Print] screen appears again.
5. To print, click the <OK> button.
To quit without printing, click the <Cancel> button.

4.7 PRINTING SYSTEM PARAMETERS

This section describes how to print system parameters.

4.7.1 Procedure

1. Select [File] - [Print]. The [Print] screen appears.

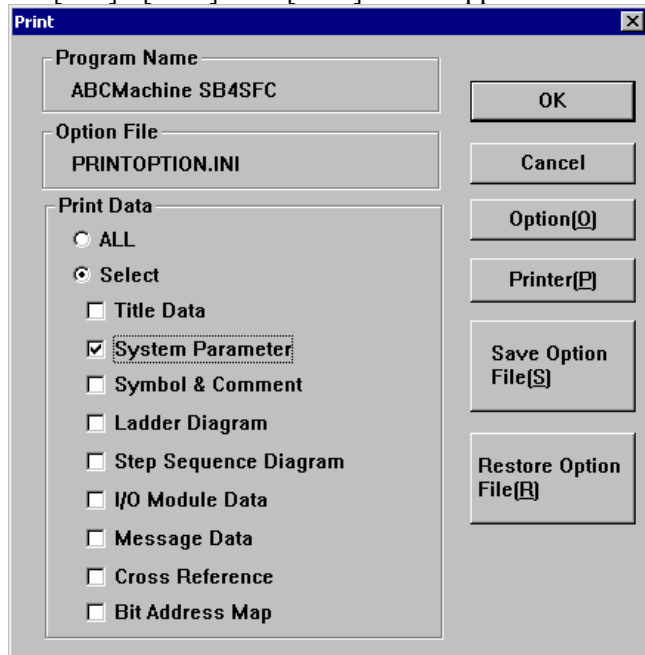

Fig. 4.7.1 (a)

- 1-1 Select System Parameter from **Print Data**.

- 1-2 Click the <Option> button. The [Option] screen appears.

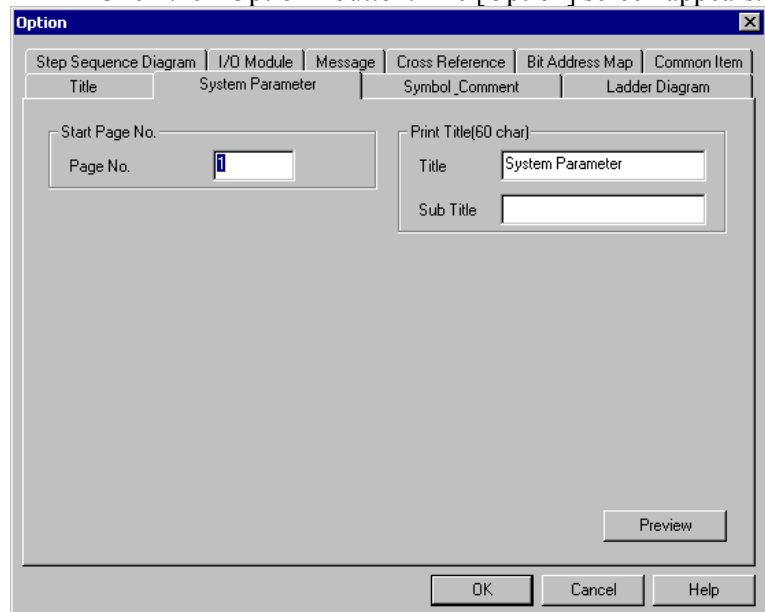

Fig. 4.7.1 (b)

2. Set up the following print options on the System Parameter tab.
 - Page No.**
Specify a start page number for system parameter printing (the Initially value is 1).

 - Title**
Specify a title for system parameter printing (the Initially value is "System Parameter").

 - Sub Title**
Specify a subtitle for system parameter printing (the Initially value is blank).
3. To preview system parameter printing, click the <Preview> button.
4. To set up the print options, click the <OK> button.
To cancel the setup of the print options, click the <Cancel> button.
The [Print] screen appears again.
5. To print, click the <OK> button.
To quit without printing, click the <Cancel> button.

4.8 PRINTING CROSS-REFERENCES

This section describes how to print cross-references.

4.8.1 Procedure

1. Select [File] - [Print]. The [Print] screen appears.

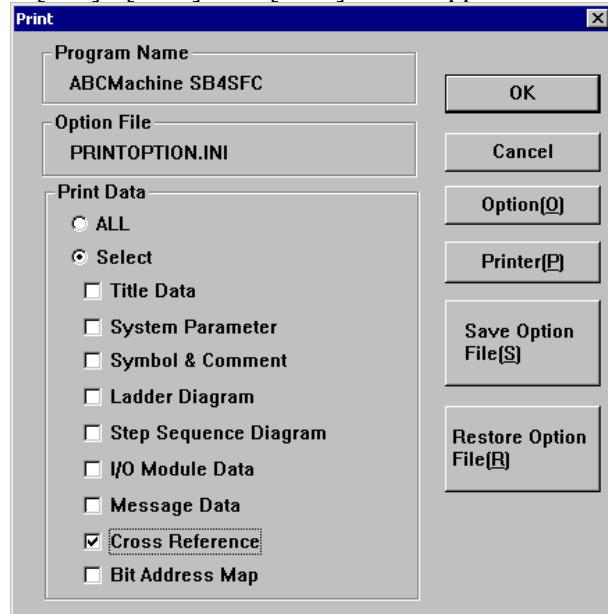

Fig. 4.8.1 (a)

- 1-1 Select Cross Reference from **Print Data**.

- 1-2 Click the <Option> button. The [Option] screen appears.

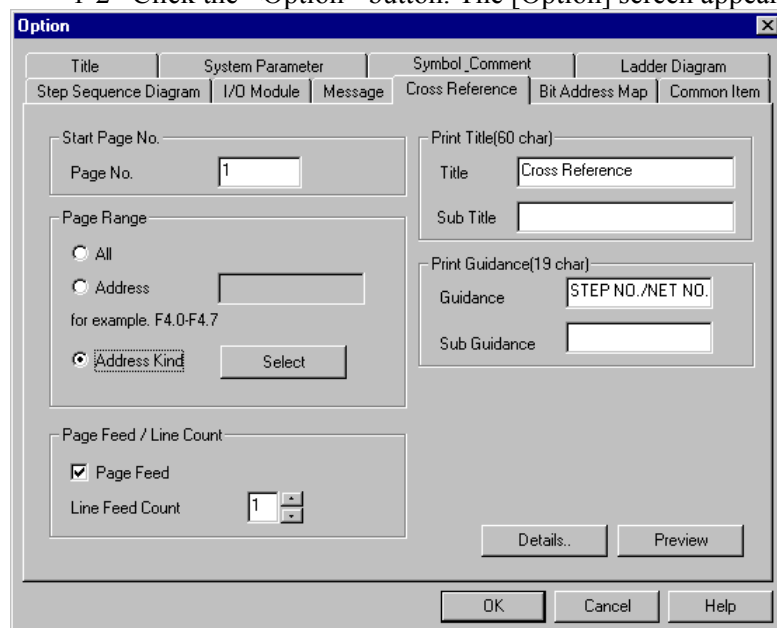

Fig. 4.8.1 (b)

2. Set up the following print options on the Cross Reference tab.

Page No.

Specify a start page number for cross-reference printing (the Initially value is 1).

Title

Specify a title for cross-reference printing (the Initially value is "Cross Reference").

Sub Title

Specify a subtitle for cross-reference printing (the Initially value is blank).

Page Range

Specify the range of cross-references to be printed (the Initially value is <All>).

All: All the cross-references will be printed.

Address: The cross-references in the specified address range will be printed.

Address Kind: Cross-references at addresses of the specified type will be printed. The kind of the address is specified by pushing the selection button.

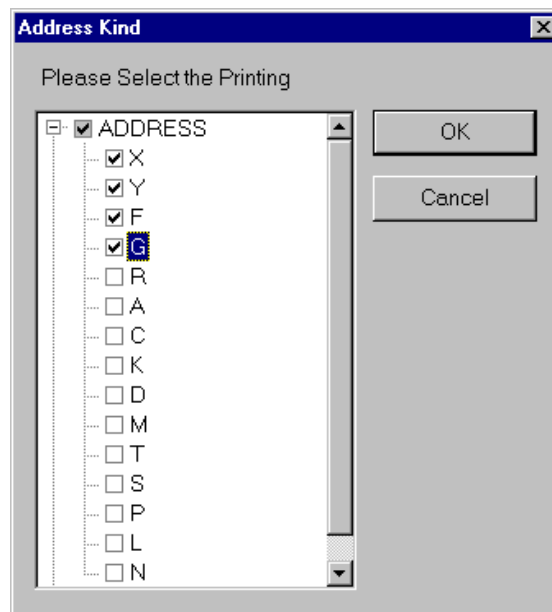

Fig. 4.8.1 (c)

Guidance

Specify the type of output format guidance (the Initially value is "STEP NO./NET NO.").

Sub Guidance

Specify the type of output format subguidance (the Initially value is blank).

Page Feed (Initially selected.)

Line Feed Count

Specify the number (0 to 9) of blank lines to be placed between addresses (the Initially value is 1).

3. To preview cross-reference printing, click the <Preview> button.
4. To specify cross-reference printing in detail, click the <Details> button.

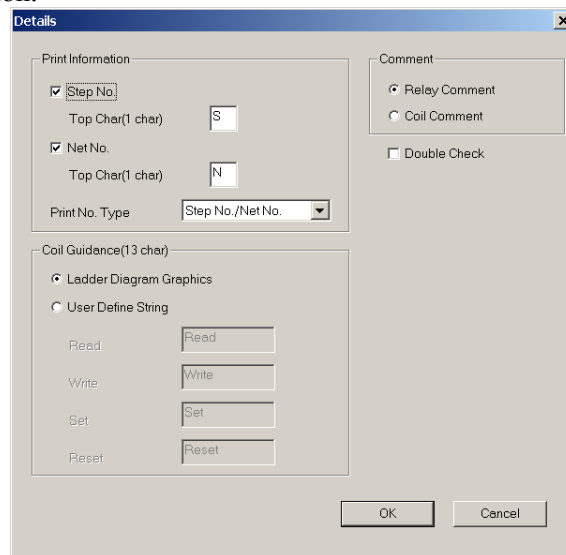

Fig. 4.8.1 (c)

Step No. (Initially selected.)

Net No. (Initially selected.)

Print No. Type (The Initially value is "Step No. /Net No. ".)

Comment

Specify the type of comment you want to print (the Initially value is <Relay Comment>).

Double Check (Initially not selected.)

Specify whether to check for duplicate coil writing and duplicate use of the coil write function instruction.

Coil Guidance

(The Initially value is <Ladder Diagram Graphics>.)

Ladder Diagram Graphics

The same graphics as those for ladder diagram printing will be used.

User Define String

User-defined character strings will be used for printing.

User-defined character strings can be set up for the following four items (up to 13 characters for each).

Read: Specify a character string for displaying read references. (The Initially value is "Read.")

Write: Specify a character string for displaying write references. (The Initially value is "Write.")

Set: Specify a character string for displaying set references. (The Initially value is "Set.")

Reset: Specify a character string for displaying reset references. (The Initially value is "Reset.")

5. To set up the print options, click the <OK> button.
To cancel the setup of the print options, click the <Cancel> button.
The [Print] screen appears again.
6. To print, click the <OK> button.
To quit without printing, click the <Cancel> button.

4.9 PRINTING BIT ADDRESS MAPS

This section describes how to print bit address maps.

4.9.1 Procedure

1. Select [File] - [Print]. The [Print] screen appears.

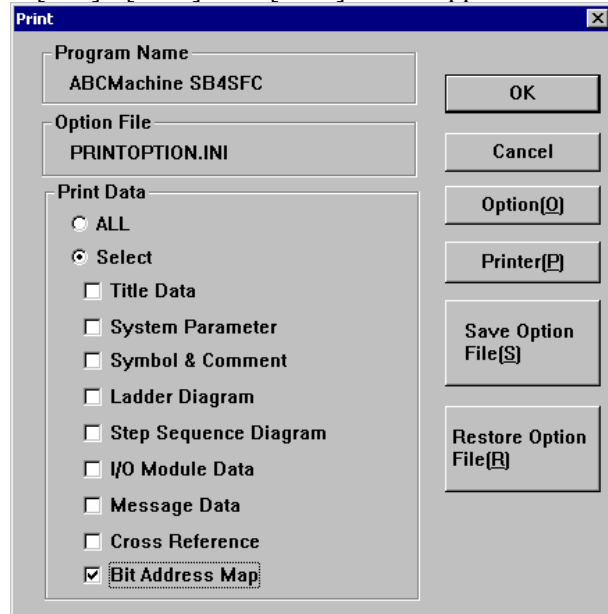

Fig. 4.9.1 (a)

- 1-1 Select Bit Address Map from Print Data.

- 1-2 Click the <Option> button. The [Option] screen appears.

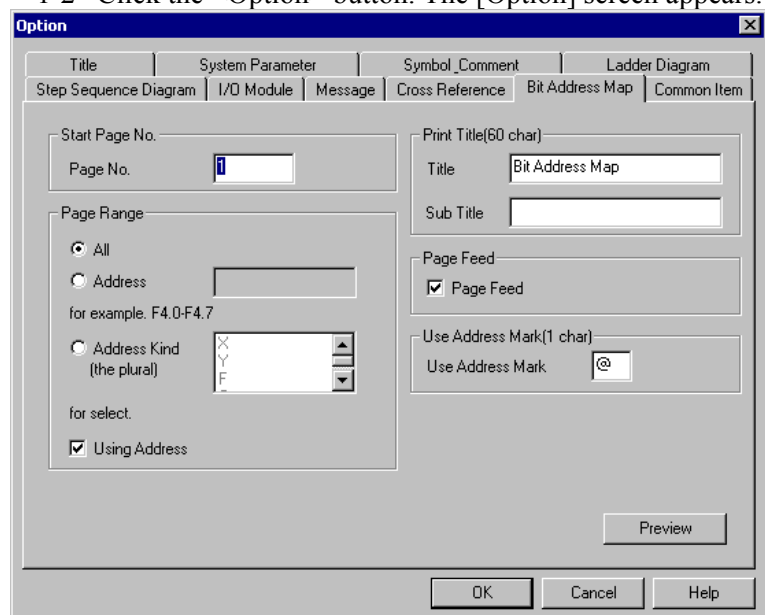

Fig. 4.9.1 (b)

2. Set up the following print options on the Bit Address Map tab.

Page No.

Specify a start page number for bit address map printing (the Initially value is 1).

Title

Specify a title for bit address map printing (the Initially value is "Bit Address Map").

Sub Title

Specify a subtitle for bit address map printing (the Initially value is blank).

Page Range

Specify the range of bit address maps to be printed (the Initially value is <All>).

All: All bit address maps will be printed.

Address: The bit map addresses in the specified address range will be printed.

Address Kind: Bit map addresses at addresses of the specified type will be printed (multiple address types can be selected).

Using Address (Initially selected.)

Page Feed (Initially selected.)

Use Address (The Initially value is "@").

Any symbol (one character) can be specified as the address symbol to be used.

3. To preview bit address map printing, click the <Preview> button.
4. To set up the print options, click the <OK> button.
To cancel the setup of the print options, click the <Cancel> button.
The [Print] screen appears again.
5. To print, click the <OK> button.
To quit without printing, click the <Cancel> button.

4.10 SETTING UP COMMON OPTIONS

This section describes how to set up options common to all print items.

4.10.1 Procedure

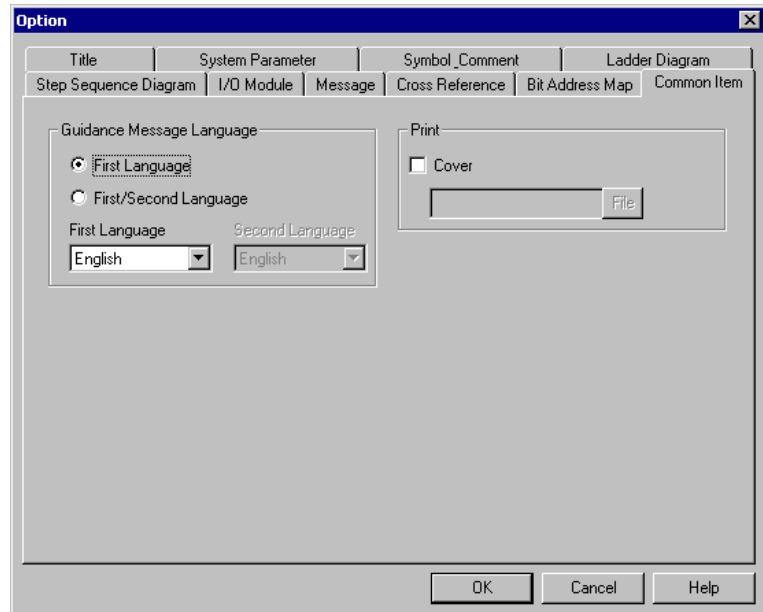

Fig. 4.10.1 (a)

1. Set up the following common options.

Guidance Message Language

Specify the language for guidance messages used when titles and system parameters are printed.
(The Initially value is <First Language>.)

First Language

Specify a title for bit address map printing (the Initially value is <English>).

Second Language

This item can be specified if <First/Second Language> is selected for Guidance Message Language (the Initially value is <English>).

Cover (Initially not selected.)

If this item is selected (the check mark is on), a meta file can be specified for the cover.

2. To set up the print options, click the <OK> button.
To cancel the setup of the print options, click the <Cancel> button.
The [Print] screen appears again.

4.11 SAVING AND READING OPTION FILE

This section describes how to save the print options you set up to a file and how to read them from the file when printing.

4.11.1 Procedure

1. Select [File] - [Print]. The [Print] screen appears.

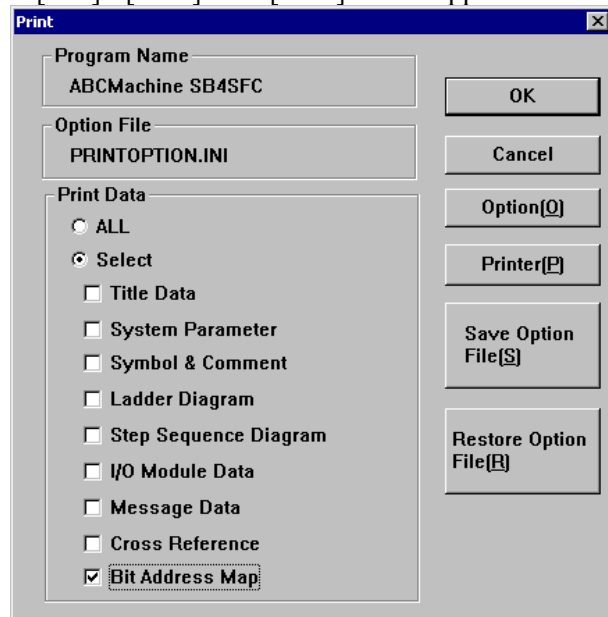

Fig. 4.11.1 (a)

2. To save the options to a file, click the <Save Option File> button.

2-1 The [Save As] screen appears.

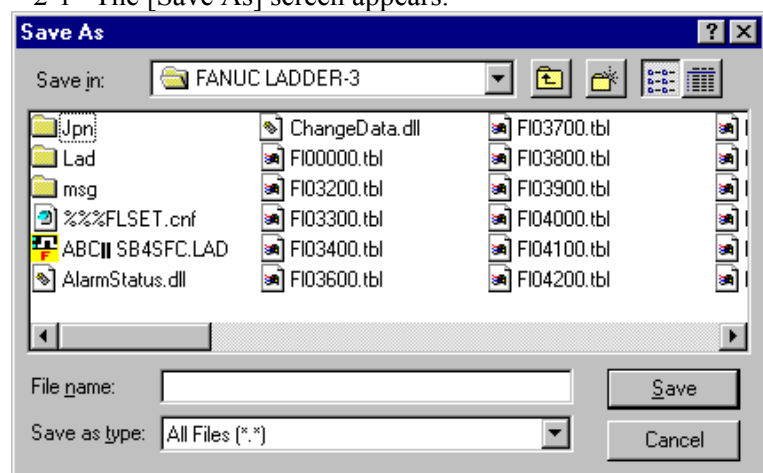

Fig. 4.11.1 (b)

2-2 Specify a **File name**.

2-3 Click the <Save> button.

3. To read options from a file, click the <Restore Option File> button.

3-1 The [Open] screen appears.

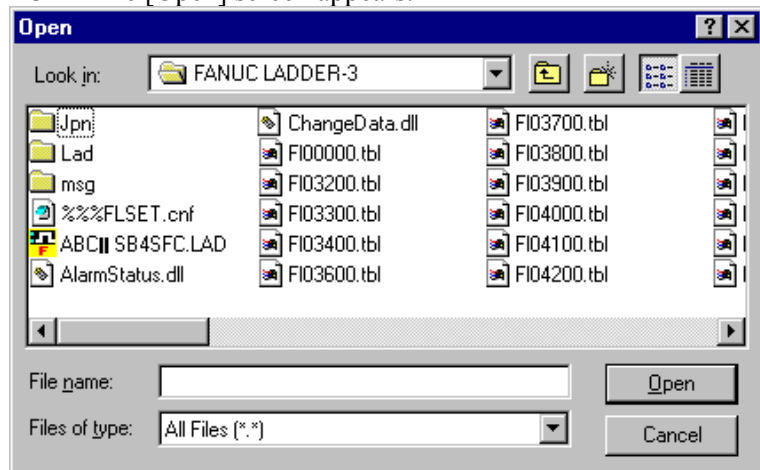

Fig. 4.11.1 (c)

3-1 Specify a **File name**.

3-2 Click the <Open> button.

NOTE

As to the storing folder of the text file, you can choose the default of the storing folder by the **Specify the same folder as a LAD file for working directory** in the [General] tab of the option.(select the [Tool] - [Option...])

Checked.....The same folder as the LAD file.
(Initial value) It is useful when saving at the same folder as the LAD file.

Not checked...The folder stored previously.
It is useful when saving to a specified folder each time.

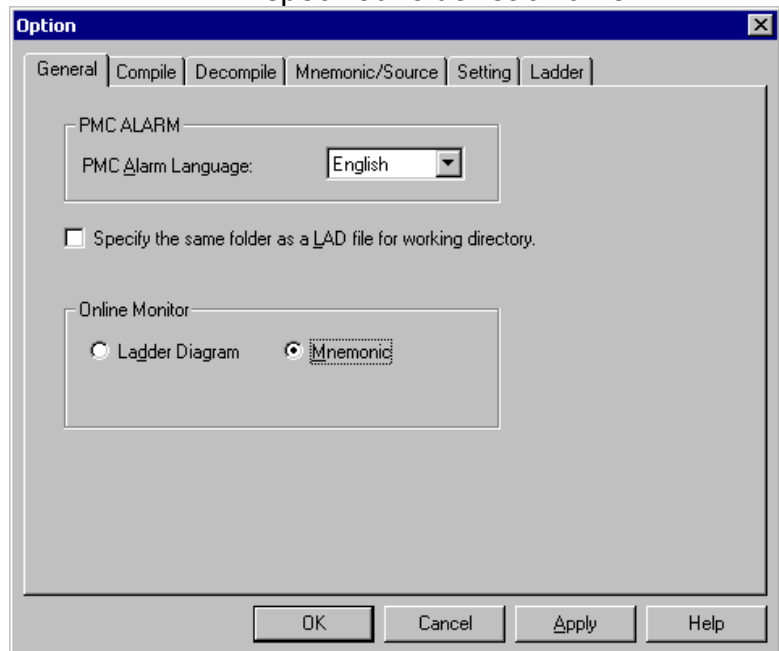

4.12 SETTING UP PRINTER

This section describes how to set up a printer.

4.12.1 Procedure

1. Select [File] - [Print]. The [Print] screen appears.

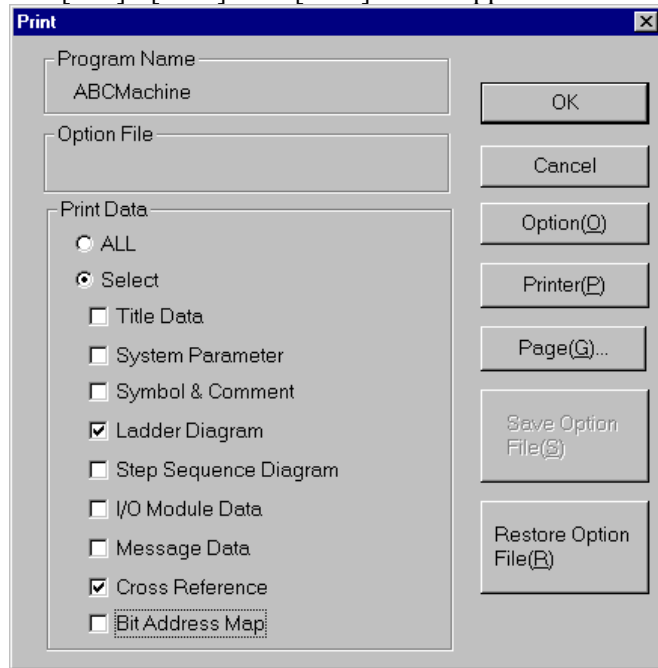

Fig. 4.12.1 (a)

2. Click the <Printer> button.

2-1 The [Printer] screen appears.

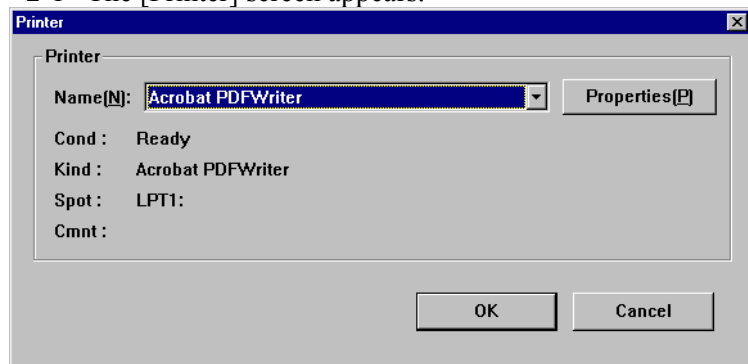

Fig. 4.12.1 (b)

- 2-2 Specify a printer name in Name.
If more than one printer has been installed in your system, one can be selected from the drop-down list box.
- 2-3 To set the displayed printer, click the <OK> button.
To cancel the setup of the printer, click the <Cancel> button.

4.12.2 Setting up Pages

1. On the [Printer] screen, click the Page button.
2. Set the items on each tab.

2-1 [Line Count] tab

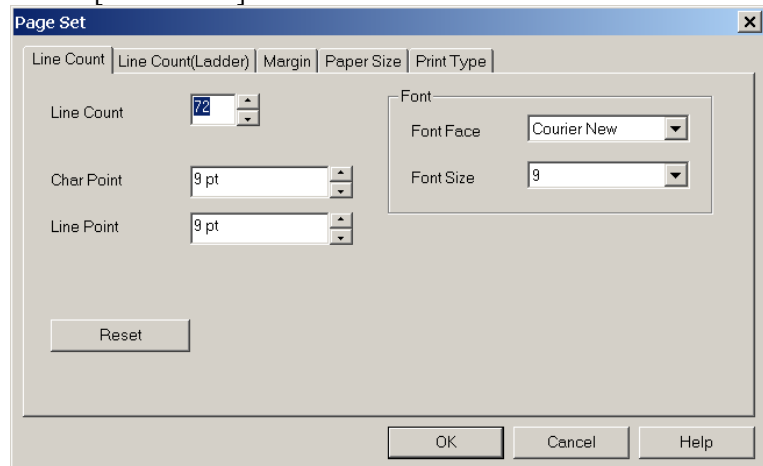

Fig. 4.12.2 (a)

Line Count

Specify the maximum number of lines that can be printed on one page. A value can be entered directly. It can also be selected by clicking the up/down arrows. (The Initially value is 72.)

Char Point

Specify the character spacing, in points. A value can be entered directly. It can also be selected by clicking the up/down arrows. The font size may be adjusted automatically according to the specified character spacing. (The Initially value is 9.)

Line Point

Specify the line spacing, in points. A value can be entered directly. It can also be selected by clicking the up/down arrows. The number of lines and the font size may be adjusted automatically according to the specified line spacing. (The Initially value is 9.)

Font Face

Specify the font you want to use. (The Initially value is <Courier New>.)

Font Size

Specify the font size you want to use. The number of lines, character spacing, and line spacing may be adjusted automatically according to the specified font size.

(The Initially value is 9.)

<Reset> button

This button clears the settings of all the items on the [Line Count] tab to the respective Initially values.

2-2 [Line Count (Ladder)] tab

Fig. 4.12.2 (b)

Line Count

Specify the maximum number of lines that can be printed on one page. A value can be entered directly. It can also be selected by clicking the up/down arrows. The line spacing and font size may be adjusted automatically according to the specified number of lines.

(The Initially value is 78.)

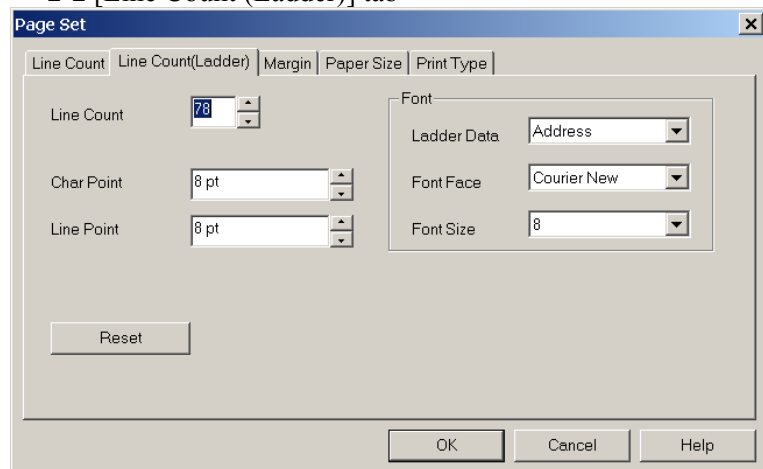
Char Point

Specify the character spacing, in points. A value can be entered directly. It can also be selected by clicking the up/down arrows. The font size may be adjusted automatically according to the specified character spacing.

(The Initially value is 8.)

Line Point

Specify the line spacing, in points. A value can be entered directly. It can also be selected by clicking the up/down arrows. The number of lines and the font size may be adjusted automatically according to the specified line spacing.

(The Initially value is 8.)

Ladder Data

Specify the ladder data for which you want to specify a font.

Font Face

Specify the name of the font you want to use for an item specified in Ladder Data.

(The Initially value is <Courier New>.)

Font Size

Specify the font size you want to use for an item specified in Ladder Data. The number of lines, character spacing, and line spacing may be adjusted automatically according to the specified font size.

(The Initially value is 8.)

<Reset> button

This button clears the settings for all the items on the [Line Count (Ladder)] tab to the respective Initially values.

2-3 [Margin] tab

Fig. 4.12.2 (c)

Upper

Specify the top margin for each page. A value can be entered directly. It can also be selected by clicking the up/down arrows. The entered value is assumed to be in mm.

(The Initially value is 20.)

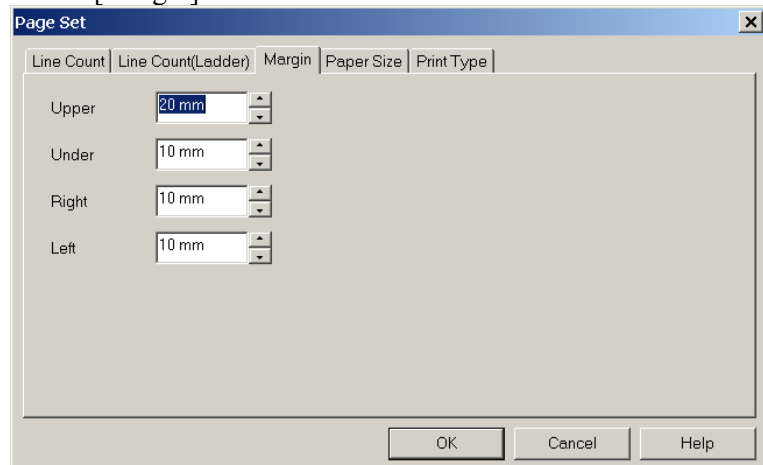
Under

Specify the bottom margin for each page. A value can be entered directly. It can also be selected by clicking the up/down arrows. The entered value is assumed to be in mm.

(The Initially value is 10.)

Right

Specify the right margin for each page. A value can be entered directly. It can also be selected by clicking the up/down arrows. The entered value is assumed to be in mm.

(The Initially value is 10.)

Left

Specify the left margin for each page. A value can be entered directly. It can also be selected by clicking the up/down arrows. The entered value is assumed to be in mm.

(The Initially value is 10.)

2-4 [Paper Size] tab

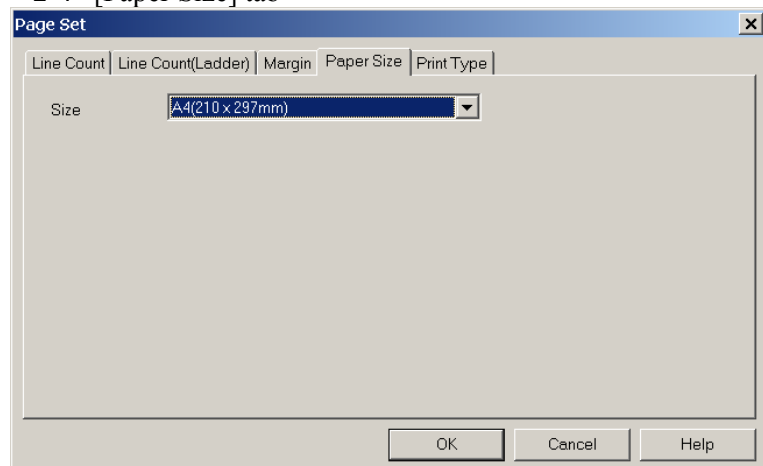

Fig. 4.12.2 (d)

Size

Specify the size of the form you want to use.
(The Initially value is <A4>.)

2-5 [Print Type] tab

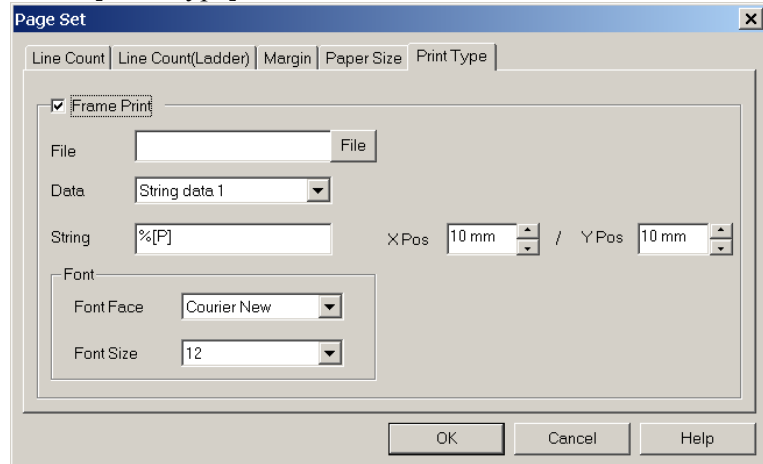

Fig. 4.12.2 (e)

Frame Print

Specify whether to print a frame. The following items can be set up only when this item is selected.

File

Specify the meta file you want to use for frame printing. The <File> button lets you select a file name.

Data

Specify the data for which you want to set up a character string, coordinate values, and font.

String

Specify a character string set up in Data as print data. Data can be specified in the following data formats.

- %[T]: Title data will be printed.
- %[S]: Subtitle data will be printed.
- %[P]: A program name will be printed.
- %[N]: Page numbers will be printed.

(Initially values)

Character definition 1: %[P]

Character definition 2: %[T]

Character definition 3: %[N]

Character definition 4: %[S]

Character definition 5: Unavailable

X Pos

Specify the print start position (X-coordinate) for a character string set up in Data. A value can be entered directly. It can also be selected by clicking the up/down arrows. The entered value is assumed to be in mm.

(Initially values)

Character string definition 1: 10

Character string definition 2: 75

Character string definition 3: 180

Character string definition 4: 75

Character string definition 5: 0

Y Pos

Specify the print start position (Y-coordinate) for a character string set up in Data. A value can be entered directly. It can also be selected by clicking the up/down arrows. The entered value is assumed to be in mm.

(Initially values)

Character string definition 1: 10

Character string definition 2: 10

Character string definition 3: 10

Character string definition 4: 15

Character string definition 5: 0

Font Face

Specify the name of the font you want to use to print the data set up in Data.

(The Initially value is <Courier New>.)

Font Size

Specify the font size you want to use to print the data set up in Data.

(The Initially value is 12.)

- 2-6 To use the entered page settings, click the <OK> button.
To cancel the page settings, click the <Cancel> button.

4.12.3 Setting Property

1. <property> button is clicked on a [Printer] dialog.
2. Property set dialog of the selected printer appears. The print condition is set to item of the selected printer.

5

COMPILED AND DECOMPILED

This chapter describes how to compile and decompile source programs, as well as automatic compilation and automatic decompilation. The chapter also describes how to protect a ladder program using a password.

- **Compilation**

Compilation involves converting an edited source program to object code that can be executed by the PMC. Unless source programs are compiled, online functions cannot be used and the source programs cannot be transferred to RAM of the PMC.

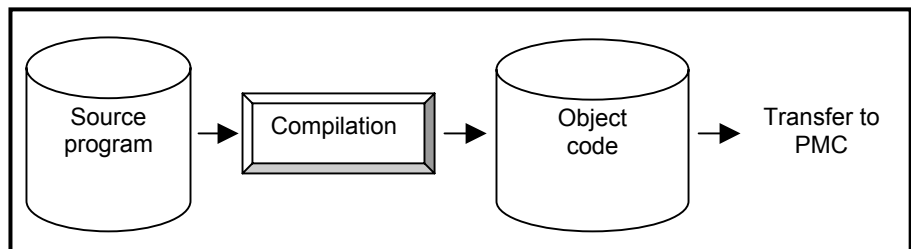

- **Decompilation**

Decompilation involves converting object code to a source program. Data items uploaded from the PMC, and data items read from ROM and a memory card become object code. Since object code can neither be edited nor printed offline, you must decompile object code.

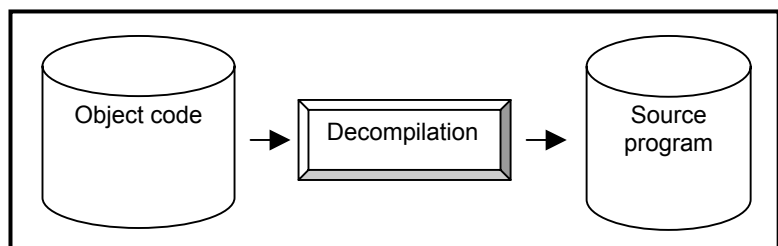
**NOTE**

To decompile an object code with a password, enter the password first.

5.1 COMPILATION

This section describes how to compile source programs.

Procedure

1. Select [Tool] - [Compile]. The [Compile] dialog appears.

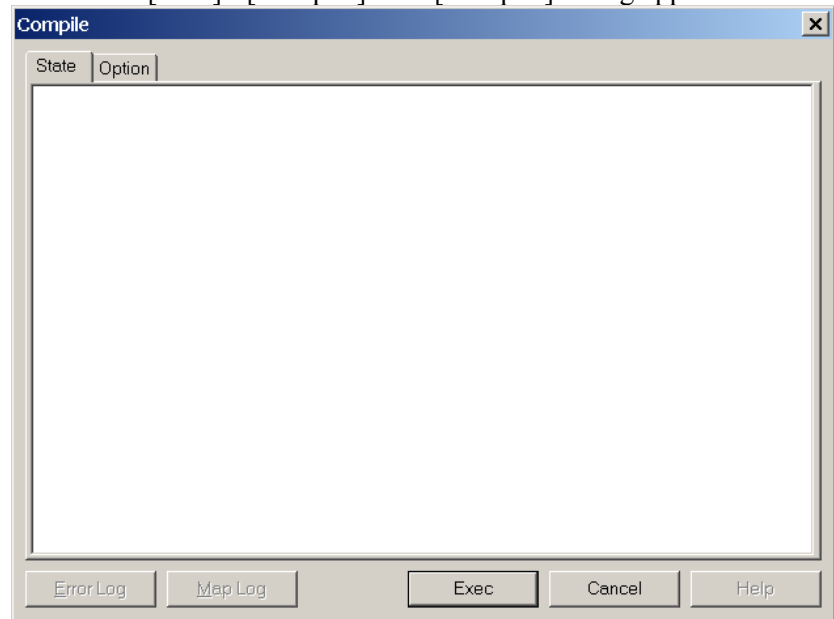

Fig. 5.1 (a)

2. Click the [Option] tab to set the compile options.
 - For PMC models that do not support multiple comments (only coil-comments)

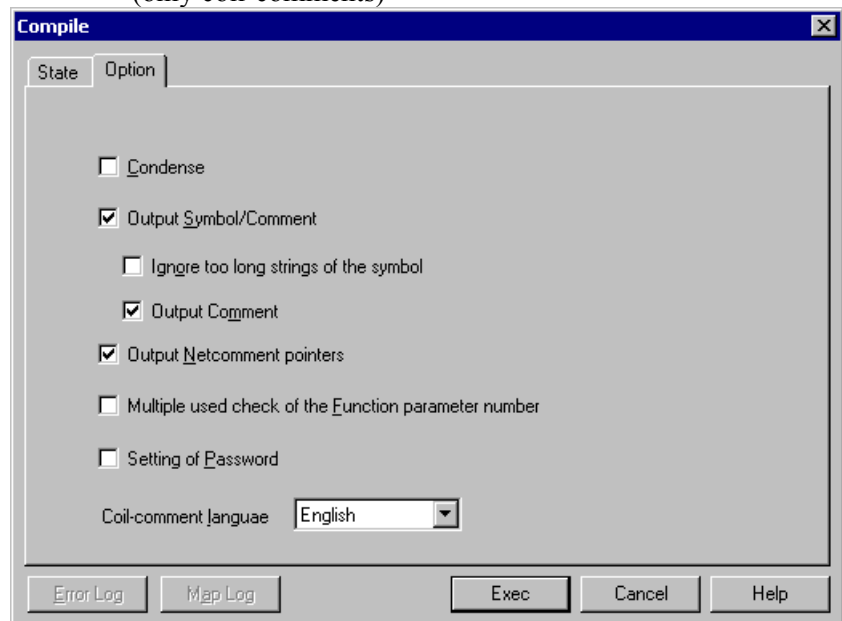

Fig. 5.1 (b)

The details of the options are listed below.

Table 5.1(a)

Option	Explanation
Condense	When a ladder that has the same number of steps is compiled, the object code is decreased.
Output Symbol/Coil-comment	A symbol that can be displayed on a display unit of CNC, and an accompanying coil comment are output to an object code.
Ignore too long strings of the symbol	Any symbol that exceeds six characters in length is replaced by a space code of six characters and output to an object code together with a coil comment.
Output Comment	A coil comment is output to an object code.
Output Netcomment pointers	A net comment pointer is output to an object code.
Multiple used check of the Function parameter number	Functions TMR, TMRB, TMRBF, CTR, DIFU, and DIFD are checked if they are duplicated. If any, a warning is displayed.
Setting of Password	A password is added to an object code. Enter a password at the start of execution.
Coil-comment language	Specify the format in which to output a coil comment to an object file when compiling a source program. English: Japanese coil comments are replaced by spaces and output to an object file. (Conventional specification) Japanese: Japanese coil comments are converted directly and output to an object file.

- PMC model which supports the multiple comments

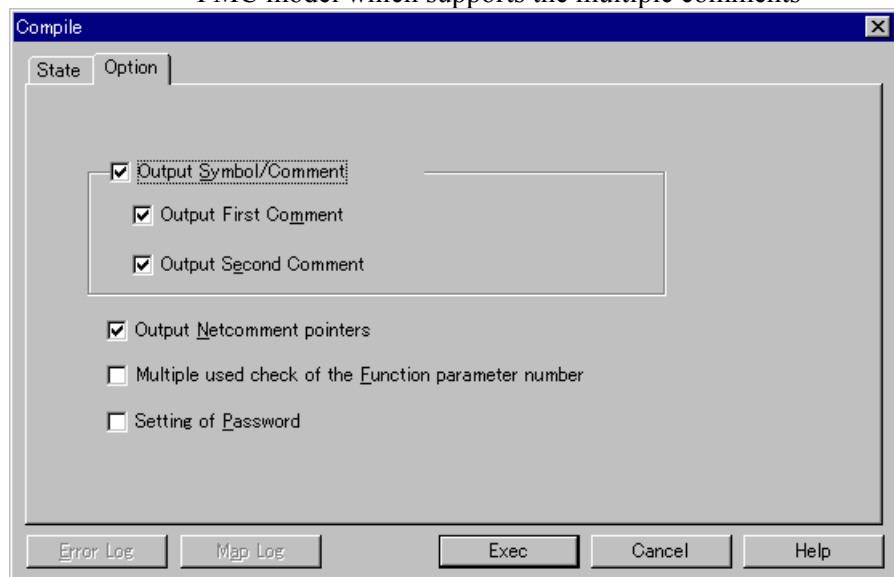

Fig. 5.1 (c)

The details of the options are listed below.

Table 5.1(b)

Option	Explanation
Output Symbol/Comment	A symbol (16 bytes or less) that can be displayed on display unit of CNC, and a comment are output to an object code.
Output First Comment	First comment is output to an object code.
Output Second Comment	Second comment is output to an object code.
Output Netcomment pointers	A net comment pointer is output to an object code.
Multiple used check of the Function parameter number	Functions TMR, TMRB, CTR, DIFU, and DIFD are checked if they are duplicated. If any, a warning is displayed.
Setting of Password	A password is added to an object code. Enter a password at the start of execution.

- To start compilation, click the <Exec> button. When [Setting of Password] in the compile option is checked, the [Password(Compile)] dialog appears. Enter a password, then click the <OK> button.

(For details of passwords, see Section 5.4, "Protecting Ladder Programs by Passwords.")

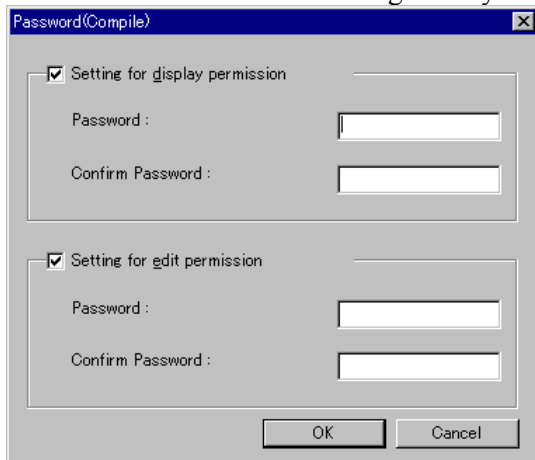

Fig. 5.1 (d)

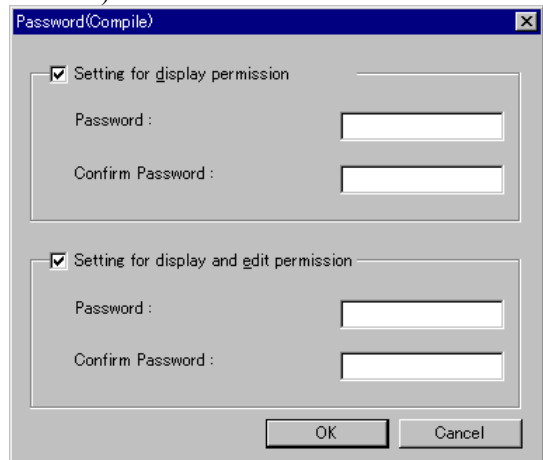

Fig. 5.1 (e)

4. While data is being compiled, the progress of the processing appears on the screen. When completed, the number of errors and warnings appears.

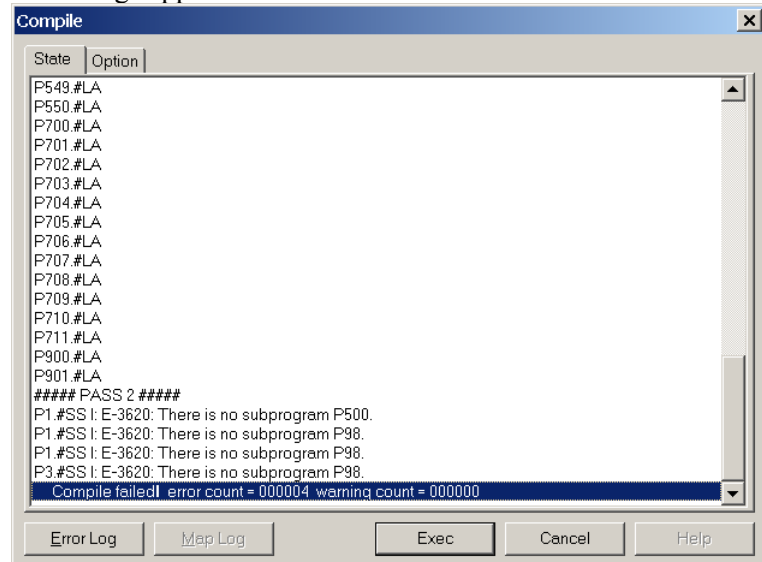

Fig. 5.1 (f)

NOTE

1 Condense mode

Condense mode has the following advantages.

- Reduced compilation time.
- Reduced transfer time from a personal computer to the PMC.
- The mode requires little ROM space.

On the other hand, the following restrictions must be observed:

- When data is edited by an integrated edit function, and if a ladder or symbol is added, overlapping with the C language area might occur. Pay careful attention to this point.

2 Net comment pointer

The net comment contains string information only in a source program. The compiled object code does not include the net comment information. Therefore, the setting to output the "net comment pointer" (position information of a net comment) as a function NOP to object code was developed. This position information enables the net comment to be restored at decompilation after a ladder is modified by online editing.

3 Symbol comment data

A relay comment, which is a type of symbol comment data, is not included in a compiled object code. For details, see Section 3.7.1, "Symbol and Comment Data."

4 PMC-SB7

On PMC-SB7, the "Condense" and "Ignore too long strings of the symbol" options are enabled unconditionally.

5. <Map Log> button

Each data size of the source program is displayed by pushing the <Map Log> button after processing of compilation. "F-ROM used" shows the size of needed Flash ROM.

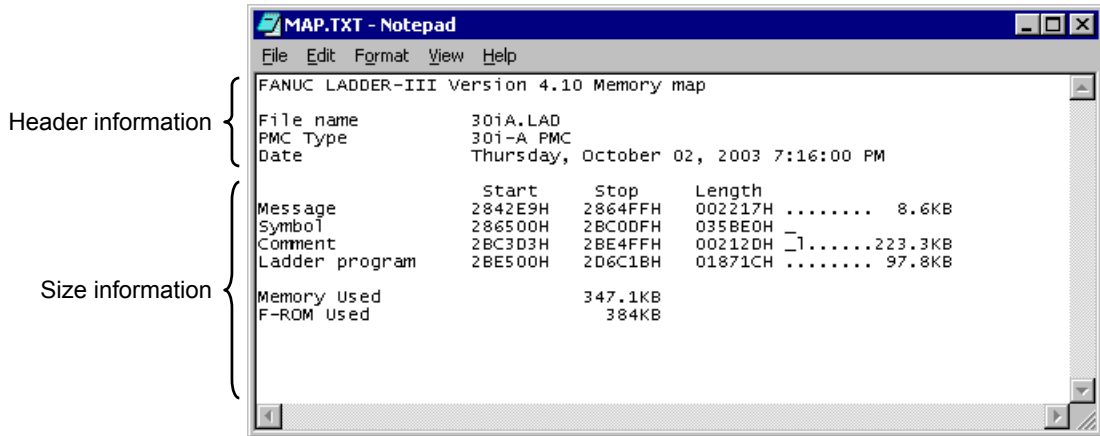

Fig. 5.1 (g)

Header information

Item	Contents
File name	LAD file name
PMC Type	The model of PMC
Date	Date the file was created.

* Date is dependent on "Regional options".

Size information

Item	Contents
Message	Data size of a message.
Symbol	Data size of a symbol and a comment.
Comment	
Ladder program	Data size of a ladder and step sequence.
Memory Used	Data size of the all ladder program .
F-ROM Used	Size of Flash ROM necessary to store a ladder program.

* KB is KByte.

NOTE

When displayed "F-ROM used" size exceeds the option of PMC ladder capacity, the ladder cannot be transmitted to PMC or may be unable to write correctly to F-ROM.

5.2 DECOMPILED

This section describes how to decompile object code.

Procedure

1. Select [Tool] - [Decompile]. The [Decompile] dialog appears.

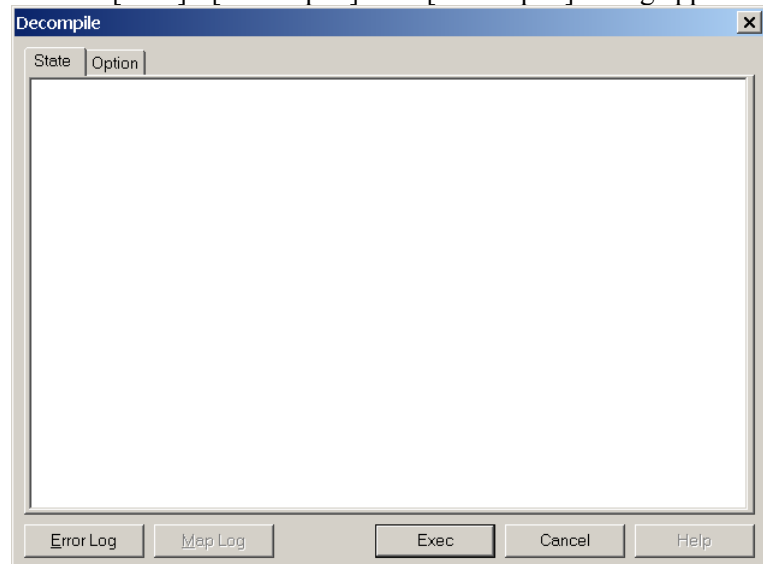

Fig. 5.2 (a)

2. Click the [Option] tab to set the decompile options.

- PMC model which supports the multiple comments

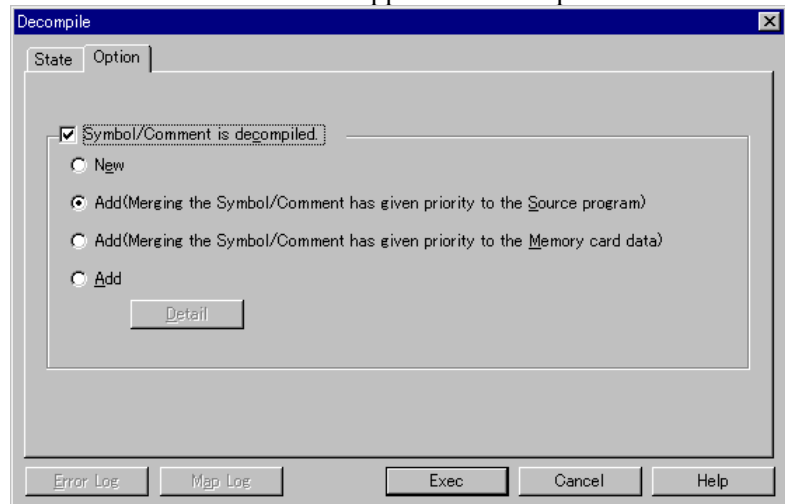

Fig. 5.2 (b)

The details of the options are listed below.

Table 5.2 (a)

Option	Explanation
Symbol/Comment is decompiled	If not checked, no symbol/comment data is decompiled. The definition of the source is directly used.
New	The definition of the source program is newly made from the symbol and comment of object code.
Add(Merging the Symbol/ Comment has given priority to the Source data)	The symbols of the source program and object code are merged only for a symbol and comment. If the same symbol and comment exist, the definition of the source program is used.
Add(Merging the Symbol/ Comment has given priority to the Memory card data)	The symbols of the source program and object code are merged only for a symbol and comment. If the same symbol and comment exist, the definition of the object code is used.
Add	The symbols of the source program and object code are merged only for a symbol and comment. If the same symbol and comment exist, the using definition can be separately selected for symbol, first comment or second comment. Please push <Detail> button and select the using definition on [Detail] dialog box.

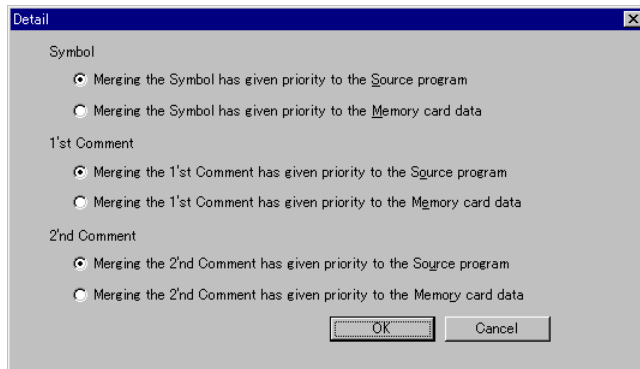

Fig. 5.2 (c)

- PMC model which does not support the multiple comments

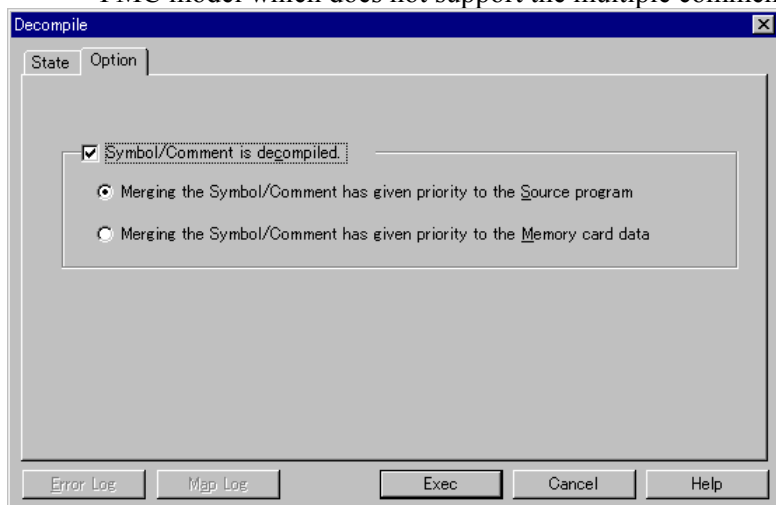

Fig. 5.2 (d)

Details of the options are listed below.

Table 5.2 (b)

Option	Explanation
Symbol/Comment is decompiled	If not checked, no symbol/comment data is decompiled. The definition of the source is directly used.
Merging the Symbol/ Comment has given priority to the <u>S</u> ource data	The symbols of the source program and object code are merged only for a symbol and comment. If the same symbol and comment exist, the definition of the source program is used.
Merging the Symbol/ Comment has given priority to the <u>M</u> emory card data	The symbols of the source program and object code are merged only for a symbol and comment. If the same symbol and comment exist, the definition of the object code is used.

- To start decompilation, click the <Exec> button. When object code with a password is to be decompiled, the [Password(Decompile)] dialog appears. Enter a password to permit display or to permit display and editing, and then click the <OK> button.

(For details on passwords, see "Protecting Ladder Programs by Passwords.")

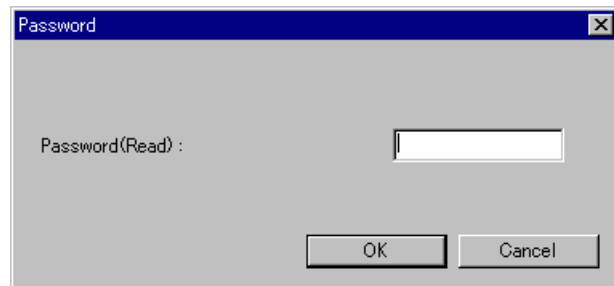

Fig. 5.2 (e)

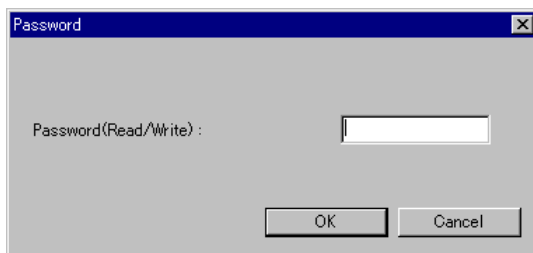

Fig. 5.2 (f)

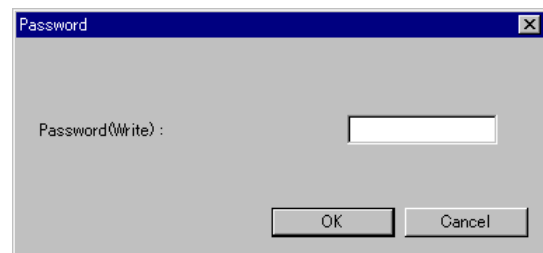

Fig. 5.2 (g)

4. Once decompilation is complete, the number of errors and warnings appears.

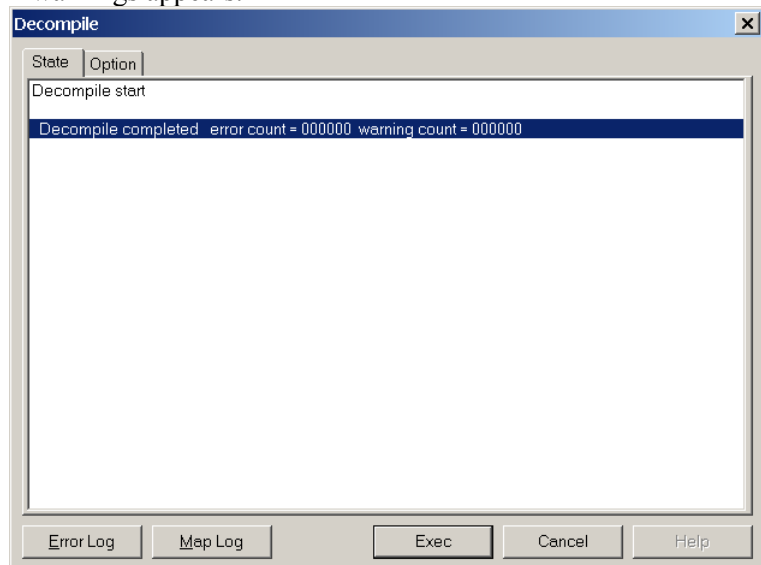

Fig. 5.2 (h)

NOTE

Password

The password to be entered differs depending on the type of the password added to an object code.

- Only Password(Read)
→ Enter Password(Read) to permit display
- Only Password(Read/Write) or Password(Write)
→ Enter Password(Read/Write) or Password(Write) to permit display and editing
- Both
→ Enter Password(Read/Write) or Password(Write) to permit display and editing

5. <Map Log> button

Each data size of the object code is displayed by pushing the <Map Log> button after processing of decompilation.

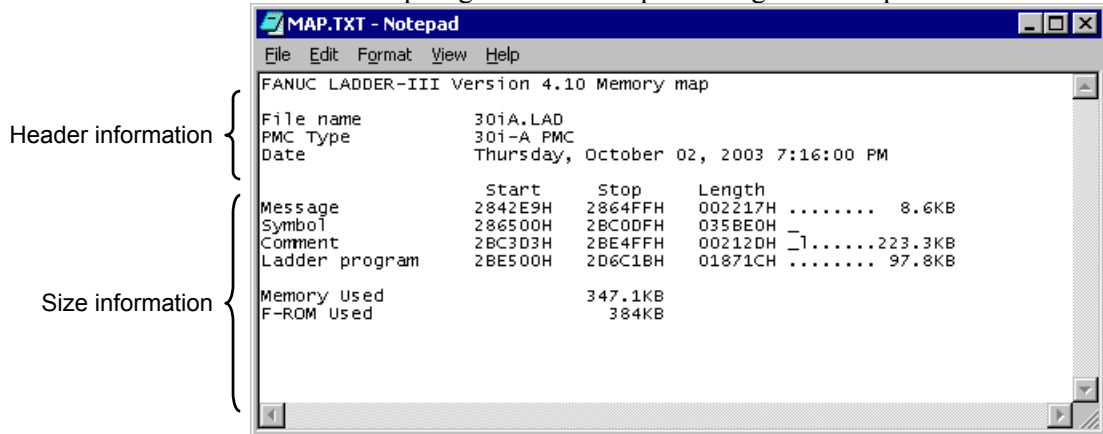

Fig. 5.2 (i)

Header information

Item	Contents
File name	LAD file name
PMC Type	The model of PMC
Date	Date the file was created.

* Date is dependent on "Regional options".

Size information

Item	Contents
Message	Data size of a message.
Symbol Comment	Data size of a symbol and a comment.
Ladder program	Data size of a ladder and step sequence.
Memory used	Data size of the all ladder program .
F-ROM used	Size of Flash ROM necessary to store a ladder program.

* KB is KByte.

6. <Update Log> button

Only the modules which were modified in the object code are decompiled.

To confirm the modified module, please press <Update Log> button.

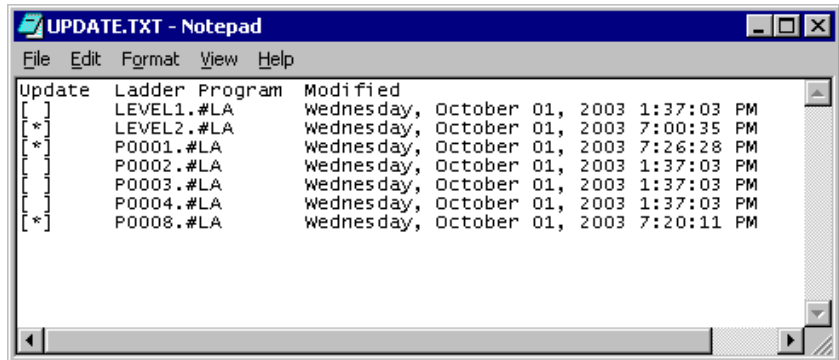

Fig. 5.2 (j)

[] The file was not updated by decompilation.

[*] The file was updated by decompilation.

NOTE

The display format of "Modified" is dependent on "Regional options". So, the contents of the display may differ.

5.3 AUTOMATIC COMPILATION AND DECOMPILED

This section describes automatic compilation and decompilation.

The automatic compilation or decompilation processing is performed when the mode is switched between offline and online so that a source program in a sequence program (LAD file) is consistent with the object code (memory card-formatted data).

- Execution condition of automatic compilation
Select [Ladder] - [Online/Offline]. When the mode is switched from offline to online, a source program is compiled automatically under one of the following conditions.
 - When a source program (such as a title or ladder) is changed
 - When a source program is imported
 - When a source program is not compiled after a sequence program is created
 - When the time stamp of memory card-formatted data is older than that of any data in a source program (when data is converted)
- Execution condition of automatic decompilation
Select [Ladder] - [Online/Offline]. When the mode is switched from online to offline, object code is decompiled automatically under one of the following conditions.
 - When memory card-formatted data is loaded from the PMC
 - When a memory card-formatted file is imported
 - When a Handy File-formatted file is imported
 - When a ROM-formatted file is imported
 - When online editing is executed
 - When the time stamp of any data in a source program is older than that of memory card-formatted data (when data is converted)

NOTE

Setting options for automatic compilation or decompilation

(1) Compile option

- Select [Tool] - [Option].
- Click the [Compile] tab for setting.

(2) Decompile option

- Select [Tool] - [Option].
- Click the [Decompile] tab for setting.

5.4 PROTECTING LADDER PROGRAMS BY PASSWORDS

This section describes the protection of a ladder program.

Adding a password to an object code prevents a ladder program from being displayed or edited on a CNC.

- How to create object code with a password
 1. Select [Tool] - [Compile].
 2. Click the [Option] tab, then select [Setting of Password].
 3. Click the <Exec> button.
 4. When the [Password(Compile)] dialog appears, enter a password.

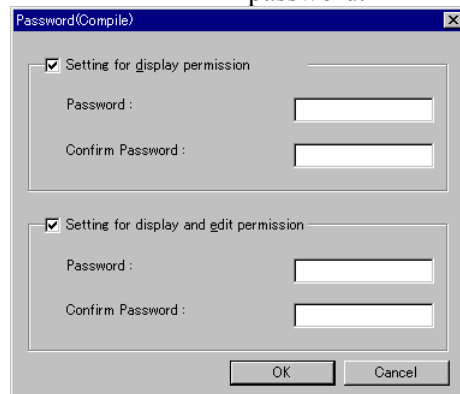

Fig. 5.4 (a)

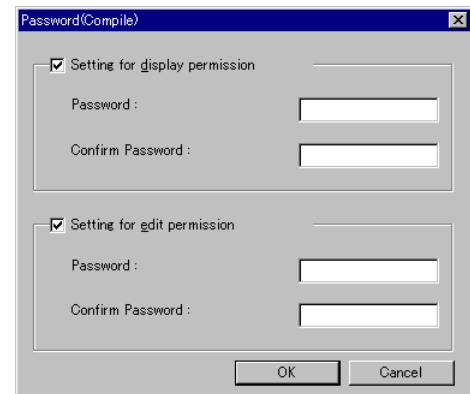

Fig. 5.4 (b)

NOTE

The different dialog by PMC model is displayed. Please refer to the manual of the corresponding PMC model for details of the password.

- 1 FANUC PMC MODEL
PA1/PA3/SA1/SA2/SA3/SA5/SB/SB2/SB3/SB4/
SB5/SB6/SB7/SC/SC3/SC4/NB/NB2/NB6
LADDER LANGUAGE PROGRAMMING
MANUAL (B-61863E)
- 2 FANUC Series 30i/300i/300is-MODEL A PMC
PROGRAMMING MANUAL (B-63983EN)

5. Click the <OK> button. Then, object code with the entered password is created.

NOTE

Entering a password

- 1 A password must consist of no more than eight or sixteen alphanumeric characters.
(The maximum length of characters is different in dependence on the PMC model.)
- 2 Passwords are not case-sensitive. (A lower-case letter is regarded as an upper-case letter.)
- 3 A space, kana character, kanji character, and special character (for example, *, #, and @) cannot be used.
- 4 There are combinations of characters, which cannot be used in some rare cases.
(An error message appears.) In this case, enter another string.

5.4.1 Partial Protect Functions

This subsection describes the partial protect function.

Using a special password to permit display and editing enables the subprogram area to be divided into a protection area and non-protection area, as well as enabling a ladder program to be partially protected. An object code with a special password is created in the same way as an object code with a normal password, except for using the special password to permit display and editing.

- **Special password**
A special password begins with #.
(Except for its beginning with #, a special password is no different from a normal password.)

The setting way has a difference by PMC model.

PMC-SB4(STEP)/SC4(STEP)/SB6(STEP)/SB6(STEP,IO-2)/
SB7/NB2(STEP)

Display item	Setting
Setting for display permission	No check
Setting for display and edit permission	Check
Password	Input a password that begins with #. E.g.: #FANUC

Extended functions for Series 30i/31i/32i-A, 30i/31i/32i-A

Display item	Setting
Setting for display permission	Check
Password	Input a normal password.
Setting for edit permission	Check
Password	Input a password that begins with #. E.g.: #FANUC

- **Protection area and non-protection area**
A subprogram number identifies the protection area and non-protection area.

Main program	LEVEL1	Protection area
	LEVEL2	Protection area
	LEVEL3	Protection area
Subprogram	P1 to P1499	Protection area
	P1500 or later	Non-protection area

- **Applied model**
PMC-SB4(STEP)/SC4(STEP)/SB6(STEP)/SB6(STEP,IO-2)/
SB7/NB2(STEP)
30i-A PMC/30i-A PMC(EXT)/30i-A PMC(2nd)
/30i-A PMC(2nd,EXT)/30i-A PMC(3rd)/30i-A PMC(3rd,EXT)
31i-A PMC/31i-A PMC(EXT)/31i-A PMC(2nd)
/31i-A PMC(2nd,EXT)/31i-A PMC(3rd)/31i-A PMC(3rd,EXT)
32i-A PMC/32i-A PMC(EXT)/32i-A PMC(2nd)
/32i-A PMC(2nd,EXT)/32i-A PMC(3rd)/32i-A PMC(3rd,EXT)

NOTE

Object code with a special password can be decompiled without entering a password. In this case, only a subprogram in the non-protection area (P1500 or later) can be displayed, edited, and printed. When compiled, [Setting of Password] in the compile option is ignored and an object code is created by using a special password added to the object code. This enables only the non-protection area to be changed while a ladder program created by a machine tool builder is protected.

5.5 AUTOMATIC NUMBERING OF TMRB/ TMRBF/ DIFU/ DIFD

If you use this function, the 1st parameter for the TMRB/ TMRBF/ DIFU/ DIFD instructions will be automatically numbered at the compiling process and you no longer have to take care of entering the specific numbers for these parameters.

Supported PMC models

Supported	30i/31i/32i-A Extended function 30i/31i/32i-A
------------------	--

Supported instructions

The 1st parameter of the following functional instructions is the target of assignment.

SUB24(TMRB)
SUB77(TMRBF)
SUB57(DIFU)
SUB58(DIFD)

To use this function, you should set the 1st parameter for the TMRB/ TMRBF/ DIFU/ DIFD instructions to 0. When the TMRB/ TMRBF/ DIFU/ DIFD instructions, that have a number 0 in the first parameter, are detected in the compiling process of the FANUC LADDER-III, their numbers are automatically generated from the last number. In this case, the TMRB/ TMRBF/ DIFU/ DIFD instructions, that have a number except 0, is detected, its number is not changed. This automatic number generation is done only at the compiling process of FANUC LADDER-III. Therefore, you can set its number to 0 in a mnemonic file or on the offline editing screen but you cannot set its number to 0 on the online editing screen which does not executes the compiling process.

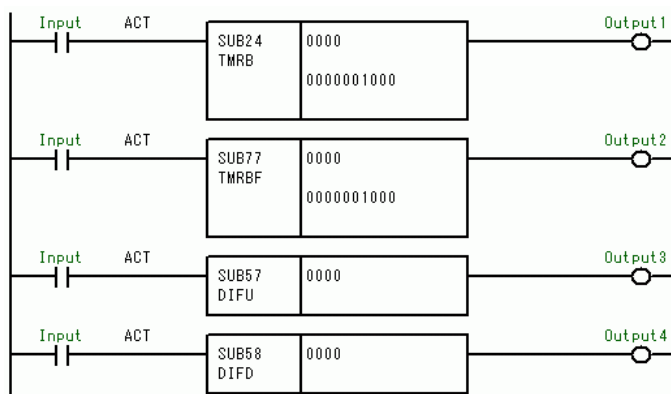

Fig. 5.5(a) Ladder diagram

RD	Input
TMRB	0
	1000
WRT	Output1
RD	Input
TMRBF	0
	1000
WRT	Output2
RD	Input
DIFU	0
	Output3
WRT	Output3
RD	Input
DIFD	0
	Output4
WRT	Output4

Fig. 5.5(b) Mnemonic data

Operation

1. Select [Tool]-[Compile...]. Then, the [Compile] dialog appears.
2. Click the <Exec> button.
3. If compile processing is completed, the error and warning are displayed.

NOTE

- 1 The result of automatic assignment is output to the map log. Push the <Map Log> button to display the net number, the functional instruction and the automatic assigned parameter number.
- 2 You can check duplication of the parameter number of the functional instruction TMR, TMRB, TMRBF, CTR, CTRB, DIFU, and DIFD. Please check the Multiple used check of the Function parameter number of the [option] tab of the [compile] screen.
- 3 The result of automatic assignment is directly added to the ladder object code. This means that the parameter number determined by automatic assignment cannot be checked in an offline edit. The parameter number remains at 0. In mnemonic language monitor display, the parameter number also remains at 0. In online monitor display, however, the parameter number determined by automatic assignment is indicated.

6

MNEMONIC EDITING

This chapter describes how to convert a source program to a mnemonic file, and vice versa, as well as the mnemonic file format.

6.1 CONVERTING SOURCE PROGRAMS TO MNEMONIC FILES

This section describes the procedure for converting a source program to a mnemonic file that can be edited with a text editor.

Procedure

1. Select [Tool] - [Mnemonic Convert...]. Then, the [Mnemonic – Mnemonic Conversion] dialog appears.

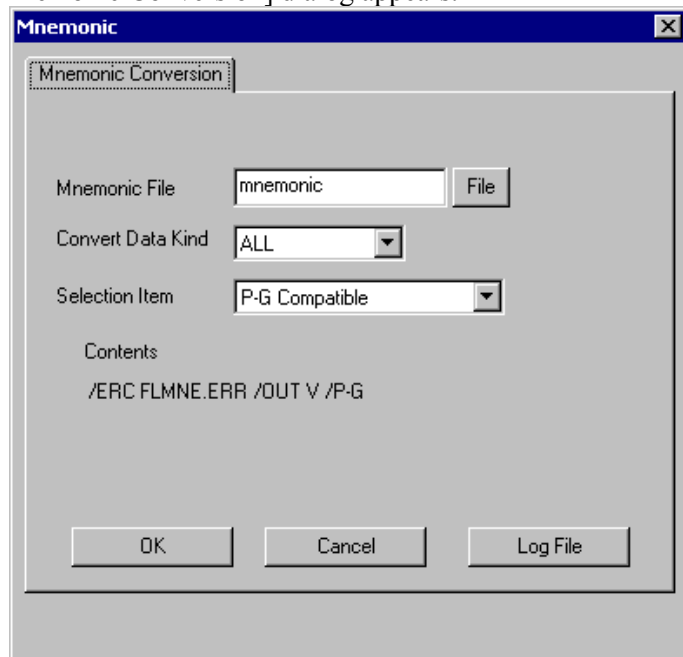

Fig. 6.1

2. Enter a mnemonic file name in [Mnemonic File].
3. Select [Convert Data Kind]. The following items can be selected:

Table 6.1(a)

ALL	Converts all source programs.
System Parameter	Converts only system parameters.
Title	Converts only titles.
Symbol&Comment No check External Symbol	Converts only symbols and comments.
Symbol&Comment Check External Symbol	Converts only symbols and comments into the external symbol file.
Ladder	Converts only ladder programs.
I/O Module	Converts only I/O modules.
Message	Converts only messages.

NOTE

The External Symbol is displayed if the external symbol file output function is supported.

4. Select [Selection Item]. The following items can be selected:

Table 6.1 (b)

P-G Compatible	<ul style="list-style-type: none"> • Converts data to data in the format output by P-G. • Converts Japanese messages to code-formatted data.
Full Options	<ul style="list-style-type: none"> • Converts comments in which kanji characters are included in the comment data. • Converts data in which the symbol and comment for an address as well as the function name of a function are used as comments. • Converts data that has an instruction part, operand part, and comment part. • Converts Japanese messages to Japanese-formatted data.
Label/ Subprogram	<ul style="list-style-type: none"> • Converts data with the jump addresses (labels) of functions (JMPB, JMPC, CALL, SP commands) used in a subprogram highlighted. However, the step number of mnemonic data after conversion is different from the other settings. (The function part used in a subprogram is different.) • Converts Japanese messages to Japanese-formatted data.

5. To convert a source program to a mnemonic file, click the <OK> button. Once the conversion is completed, the conversion results appear.
(To see the last converted results, click the <Log File> button.)

6.1.1 Converts to the External Symbol File

This function outputs the symbol/comment of external symbol file format. External symbol files are composed of identification code and the comma separated text file. You can edit the symbol/comment data by the external application such as Microsoft Excel, Text editor. The same data as the one explained in “3.15.2 Export of the external symbol file” is outputted.

Operation

1. Select [Tool]-[Mnemonic Convert...]. Then, the [Mnemonic] screen appears.

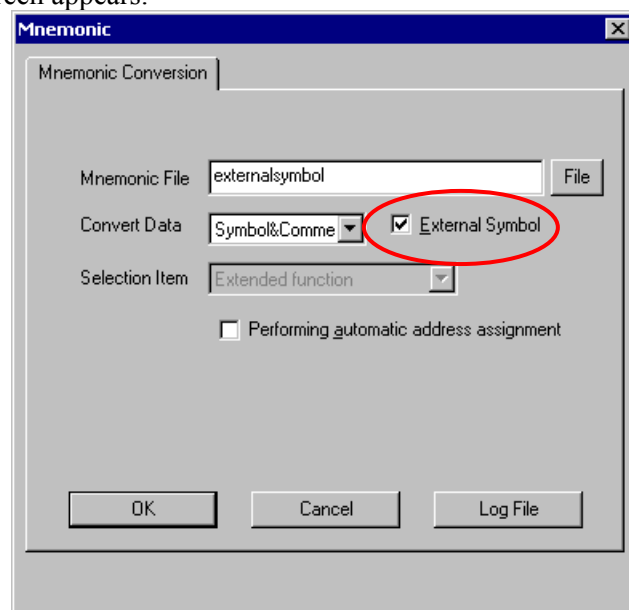

Fig 6.1.1(a)

2. Input the file name to output in the [Mnemonic File].
3. Select the [Convert Data]. Select the “Symbol&Comment”.
4. Check the External Symbol.
5. Check the Performing automatic address assignment if needed. This item appears when the PMC model is the extended function.
Check :
The address of the symbol is assigned automatically. Beforehand, you need to specify the assignment address range on the system parameter screen.
No check (Default) :
The address is not assigned automatically and outputted with the address character only.
6. Click the <OK> button.

NOTE

- 1 When a white-space character is contained in the symbol, it can be replaced with the specified character. Select [Tool] – [Option...]. Click [Mnemonic/Source] tag. Input the character to replace in Converting to a mnemonic file. Default is _(underbar).
- 2 L address of LABEL type is always automatically assigned regardless of this setting.
- 3 Refer to “Appendix E The data format of the external symbol file” for the data format of the external symbol file.

6.2 CONVERTING MNEMONIC FILES TO SOURCE PROGRAMS

This section describes the procedure for converting a mnemonic file edited by a text editor to a source program in accordance with a certain format.

Procedure

- 1 Select [Tool] - [Source Program Convert]. Then, the [Mnemonic – Source Program Conversion] dialog appears.

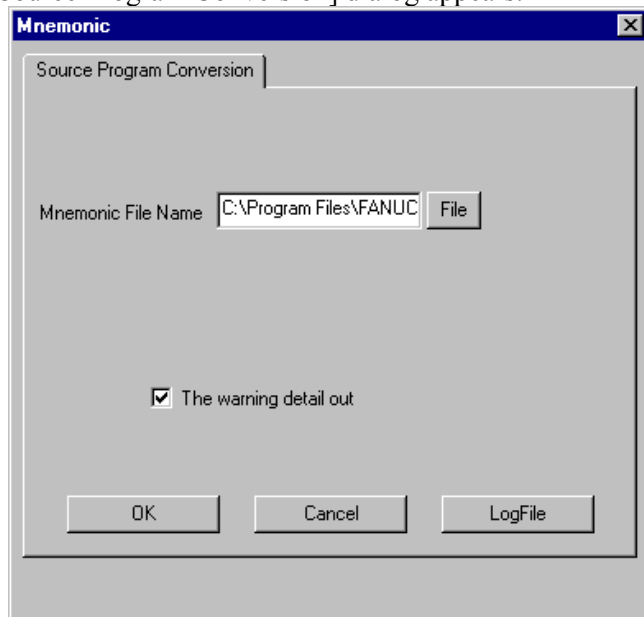

Fig. 6.2

- 2 Enter a mnemonic file name in [Mnemonic File Name].
- 3 When checking is enabled, a warning is output to a log file when it occurs during conversion of a symbol & comment mnemonic file to a source program. (Conventional specification)
When checking is disabled, the warnings and the number of occurrences are output to a log file at the end of conversion of a symbol & comment mnemonic file to a source program.
Target warning numbers: K:W-4131, K:W-4133, K:W-4139
- 4 To convert a mnemonic file to a source program, click the <OK> button.
Once the conversion is complete, the conversion results appear. (To see the most recently converted results, click the <Log File> button.)

NOTE

- 1 For conversion to a source program, the source program of the currently open sequence program is changed but is not stored, however.
- 2 For a coil comment, created in A or B format, that contains single-byte lowercase alphabetic characters, the lowercase characters are replaced with uppercase characters when a mnemonic file is converted to a source program.
- 3 If the name of defined symbol data is the same as a signal name available in ladder programs, an error may occur during conversion to source data.

6.2.1 Addition of Symbol/Comment and Net Comment

This subsection describes how to add Symbol/Comment and Net comment when converting a mnemonic file divided into multiple files to a source program.

Follow the procedure below to add Symbol/Comment and Net comment during conversion to a source program.

Procedure

1. Select [Tool] – [Source Program Convert...]. Then, the [Mnemonic – Source Program Conversion] dialog appears.

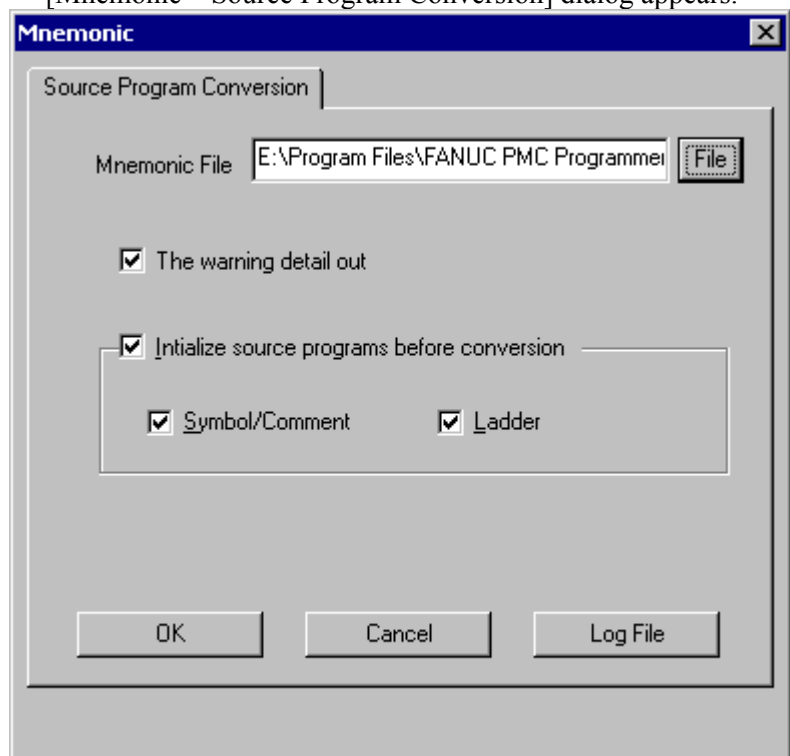

Fig. 6.2.1

2. When [Initialize source programs before conversion] is not checked, Symbol/Comment and Net comment are added.
3. When [Initialize source programs before conversion] is checked and [Symbol/Comment] is not checked, Symbol/Comment is added. ([Symbol/Comment] can not be checked if [Initialize source programs before conversion] is not checked.)
4. When [Initialize source programs before conversion] is checked and [Ladder] is not checked, Net comment is added. ([Ladder] can not be checked if [Initialize source programs before conversion] is not checked.)
5. To convert a mnemonic file to the source program, click the <OK> button.

Example of a mnemonic file division

```
; System parameter
%@0
2 BINARY
3 NO
4 PMC-SB7
7 150
11 UNUSE
12 0
13 UNUSE
14 0
%
```

```
; Title
%@1
01 MTB NAME
02 MACHINE TOOL NAME
03 CNC/PMC NAME
04 9999
05 88
06 A08B-9210-J505
07 2003-07-31
08 NAME
09 NAME
10 REMARKS
%
```

```
; Message
%@4
A000.0 MESSAGE1
A000.1 MESSAGE2
%
```

```
; I/O module
%@5
CH01: X000 0 0 1 ID32A

Y000 0 0 2 OD32A
%
```

```
; Symbol(LEVEL1)
%@2-C
X0000.0 I_L1_MODULE_00_0
$1 'INPUT 00.0'
Y0001.0 O_L1_MODULE_01_0
$1 " 'OUTPUT MODULE
01.0'
```

```
; Ladder(LEVEL1)
%@3
(*
PROGRAM $name$ LEVEL1
VERSION $version$ 0.01
DATE $date$ 2003.08.01
PROGRAMMED BY $author$
COPYRIGHT (C) 2003, FANUC LTD.
*)
RD I_L1_MODULE_00_0
WRT O_L1_MODULE_01_0
END1
%
```

```
; Symbol(LEVEL2)
%@2-C
X0001.1 I_L2_MODULE_01_1
$1 'INPUT 01.1'
Y0002.1 O_L2_MODULE_02_1
$1 " 'OUTPUT MODULE 02.1'
%
```

```
; Ladder(LEVEL2)
%@3
(*
PROGRAM $name$ LEVEL2
VERSION $version$ 0.01
DATE $date$ 2003.08.01
PROGRAMMED BY $author$
COPYRIGHT (C) 2003, FANUC LTD.
*)
RD I_L2_MODULE_01_1
WRT O_L2_MODULE_02_1
END2
%
```

```
; Symbol(P0001)
%@2-C
X010.1.1 I_P1_MODULE_10_1
$1 'INPUT 10.1'
Y012.1 O_P1_MODULE_12_1
$1 " 'OUTPUT MODULE 12.1'
%
```

```
; Ladder(P0001)
%@3
P1 SP
(*
PROGRAM $name$ P0001
VERSION $version$ 0.01
DATE $date$ 2003.08.01
PROGRAMMED BY $author$
COPYRIGHT (C) 2003, FANUC LTD.
*)
RD I_P2_MODULE_10_1
WRT O_P2_MODULE_12_1
SPE
%
```

6.3 MNEMONIC FILE FORMAT

This section describes the mnemonic file format.

Identification code

For a mnemonic file, data is defined using one of four types of identification code, beginning with %.

Table 6.3 (a)

Identification code	Meaning
%@A	Start of ALL-format data
%@E	End of ALL-format data
%@0 to %@5	Start of each single-format data %@0: System parameter %@1: Title %@2: Symbol and comment (FORMAT-A/B) %@2-C: Symbol and comment (FORMAT-C) %@2-C2: Symbol and comment (For multiple comments) %@2-D: Symbol and comment (Extended function) %@2-E (optional setting): Symbol and comment (CSV format) %@3: Ladder %@3-D: Ladder (Extended function) %@4: Message %@5: I/O module
Only %	End of each single-format data

Line feed code

LF (0AH) is used as the line feed code.
 CR (0DH) is ignored.

Delimiter

Table 6.3 (b)

; (Semicolon)	This is used in ladder data. <ul style="list-style-type: none"> This is used in the ladder data part to delimit ladder data and a comment statement. Data after “;” is regarded as being a comment statement. Consequently, when a mnemonic file is converted to a source program, data after “;” is not converted but deleted.
: (Colon)	This is used in ladder data and I/O module data. <ul style="list-style-type: none"> This is used in a ladder data part to delimit net numbers and ladder data. Data before “:” is regarded as being net numbers. This is used in the I/O module data part to delimit channel numbers and I/O module data. Data before “:” is regarded as being channel numbers.

Control character

In a mnemonic file, a dollar sign “\$” is used as the control character. When a dollar sign is used in a string, describe “\$.”

(1) Symbol and comment data

- Specifying address and symbol
Describe an address and symbol on the same line. At the beginning of a line, describe an address, use a half-size space or tab as a delimiter, and then describe a symbol.

```
R0200.0 UNIT-3-POWER
```

- Specifying a relay comment and coil comment
Describe a relay comment and coil comment after the specification of an address described in (1). A string enclosed in the first single quotation marks “'” after “\$1” is a relay comment. A string enclosed in the second single quotation marks is a coil comment.

```
$1 'KEEPOWERON' 'KEEPOWERON'
```

Mark that represents comment data (always '\$1')

When you do not use a relay comment, describe a pair of single quotation marks for the relay comment part.

```
$1 '' 'INITIALIZE OF SEQUENCE'
```

- Specifying the multiple comments
Describe a comment for multi-language display after the specification of an address described in (1). A string enclosed in the first single quotation marks “'” after “\$1” is 1st comment. A string enclosed in the second single quotation marks is 2nd comment.

```
$1 'KEEPOWERON' 'KEEPOWERON'
```

Mark that represents comment data (always '\$1')

When you do not use 1st comment, describe a pair of single quotation marks for the 1st comment part.

```
$1 '' 'INITIALIZE OF SEQUENCE'
```

NOTE
 When you use a single quotation mark “ ’ ” in a string of a relay comment or coil comment, describe a dollar sign plus a single quotation mark as “\$” + “ ’ ”.

(2) Ladder data

- Starting and ending a net comment
 Describe a net comment with “(,” “)”” in a ladder mnemonic.

Table 6.3 (c)

Description	Meaning
(*	Start of a net comment
*)	End of a net comment

- Specifying the position of a form feed character (printing a ladder diagram)
 To specify the position of a form feed character to print a ladder diagram, describe “\$P” in a net comment.

Table 6.3 (d)

Description	Meaning
\$P or #p	Specification of position of form feed character (printing ladder diagram)

(3) Control character in a mnemonic file

The control character is selectable in the following character.

#, \$, %, &, /, ?, @, ^, (None)

To change the control character in a mnemonic file, please modify a file %%%FLSET on the install folder of this software.

%%FLSET

```

=====
;
;          FANUC LADDER-III Initial Setting File
;                               ( `key word =' <= 9characters )
;=====
;
;
*M;  ===== Mnemonic options definition =====
;
SFC=0;
;
NETCMT_CTRL_CHAR=$;
    
```

Fig. 6.3 (a)

NOTE

- 1 If you don't need the control character in a mnemonic file, please set "NETCMT_CTRL_CHAR=NULL" in a file %%%FLSET.
- 2 When the control character is used in a string, please describe two consecutive control characters.
Ex.) When the control character is "#", please describe "##".
- 3 When specifying the position of a form feed character (printing a ladder diagram), please describe "a control character" + "P" in a net comment.
- 4 If this software is updated with the new released installer, a file %%%FLSET is initialized and the line of "NETCMT_CTRL_CHARA=" is deleted. After reinstalling this software, please set "NETCMT_CTRL_CHARA=" again if you want to change the control character in a mnemonic file.

(Example)
When the control character is "\$".

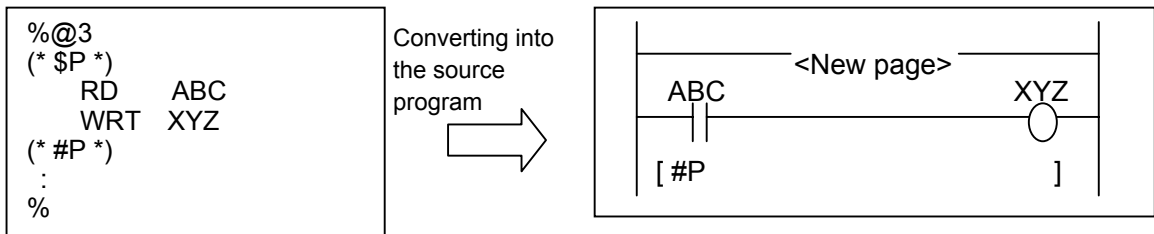

Fig. 6.3 (b)

When the control character is "#".

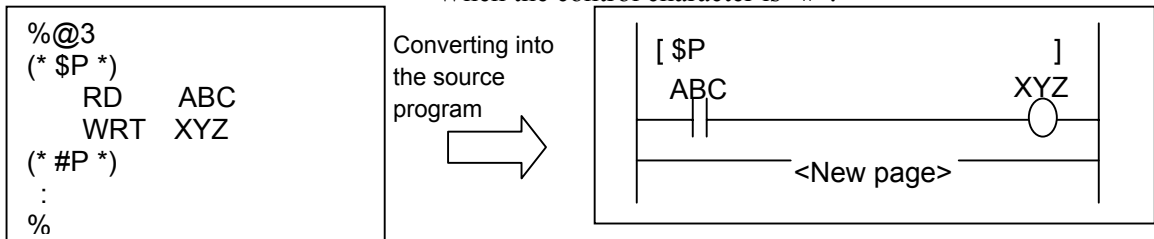

Fig. 6.3 (c)

6.4 MNEMONIC FILE SAMPLE

This section provides examples of mnemonic files for the single format and All format.

6.4.1 Single Format

This section shows a sample file for each single-format data.

6.4.1.1 Parameter

%@0	
2 BCD	→ Counter data type
3 NO	→ Presence or absence of operator panel
4 PMC-RC4	→ PMC type
5 000000	→ Head address of language program link control statement data
6 50	→ Time ratio to execute language program
7 100	→ Ladder execution time
%	

Counter data type

BINARY or BCD

Presence or absence of operator panel

No operator panel: NO

Operator panel: YES X0000 Y0000 R0000 R0010

KEY address

KEY image address

LED address

LED image address

PMC type

Table 6.4.1.1

PMC model	Setting data (half-size string)
30i-A PMC	30i-A PMC
30i-A PMC(2nd)	30i-A PMC(2nd)
30i-A PMC(3rd)	30i-A PMC(3rd)
30i-A PMC(DCS)	30i-A PMC(DCS)
30i-A PMC(EXT)	30i-A PMC(EXT)
30i-A PMC(2nd,EXT)	30i-A PMC(2nd,EXT)
30i-A PMC(3rd,EXT)	30i-A PMC(3rd,EXT)
30i-A PMC(DCS,EXT)	30i-A PMC(DCS,EXT)
31i-A PMC	31i-A PMC
31i-A PMC(2nd)	31i-A PMC(2nd)
31i-A PMC(3rd)	31i-A PMC(3rd)
31i-A PMC(DCS)	31i-A PMC(DCS)
31i-A PMC(EXT)	31i-A PMC(EXT)
31i-A PMC(2nd,EXT)	31i-A PMC(2nd,EXT)
31i-A PMC(3rd,EXT)	31i-A PMC(3rd,EXT)
31i-A PMC(DCS,EXT)	31i-A PMC(DCS,EXT)
32i-A PMC	32i-A PMC
32i-A PMC(2nd)	32i-A PMC(2nd)
32i-A PMC(3rd)	32i-A PMC(3rd)
32i-A PMC(DCS)	32i-A PMC(DCS)
32i-A PMC(EXT)	32i-A PMC(EXT)
32i-A PMC(2nd,EXT)	32i-A PMC(2nd,EXT)
32i-A PMC(3rd,EXT)	32i-A PMC(3rd,EXT)
32i-A PMC(DCS,EXT)	32i-A PMC(DCS,EXT)
PMC-SA1	PMC-RA1
PMC-SA3	PMC-RA3
PMC-SA5	PMC-RA5
PMC-SB3	PMC-RB3
PMC-SB4	PMC-RB4
PMC-SB4 (STEP SEQ)	PMC-RB4 (STEP SEQ)
PMC-SB5	PMC-RB5
PMC-SB6	PMC-RB6
PMC-SB6 (STEP SEQ)	PMC-RB6 (STEP SEQ)
PMC-SB6 (IO-2)	PMC-RB6 (IO-2)
PMC-SB6 (STEP, I/O-2)	PMC-RB6 (STEP, I/O-2)
PMC-SB7	PMC-RB7
PMC-SB7 (STEP SEQ)	PMC-RB7 (STEP SEQ)
PMC-SC3	PMC-RC3
PMC-SC4	PMC-RC4
PMC-SC4 (STEP SEQ)	PMC-RC4 (STEP SEQ)
PMC-NB	PMC-NB
PMC-NB2	PMC-NB2
PMC-NB6	PMC-NB6
PMC-PA3	PMC-PA3
PMC-QC	PMC-QC

Head address of language program link control statement data
0, or 800000 to 8FFFFFF (hex)

Time ratio to execute language program
1 to 99 (%)

Ladder execution time
100 (fixed at 100%)

I/O link assignment selection function (channel 1)
Used: USE
Not used: UNUSE

Number of basic I/O link groups (channel 1)
0 to 16

I/O link assignment selection function (channel 2)
Used: USE
Not used: UNUSE

Number of basic I/O link groups (channel 2)
0 to 16

The parameters for each model are described below.

(1) For PMC-PA3/SA3/SA5/SB4/SB5/SB6

%@0		
2 BINARY	2: Counter data type	(BINARY or BCD)
3 NO	3: Presence or absence of operator panel	(Presence: YES, Absence: NO)
4 PMC-RB5	4: PMC type	(PMC-PA3/PMC-RA3/PMC-RA5/PMC-RB4/PMC-RB5/PMC-RB6)
%		

(2) For PMC-SB3/NB6

%@0		
2 BINARY	2: Counter data type	(BINARY or BCD)
3 NO	3: Presence or absence of operator panel	(Presence: YES, Absence: NO)
4 PMC-NB6	4: PMC type	(PMC-RB3/PMC-NB6)
7 100	7: Ladder execution time	(fixed at 100%)
%		

(3) For PMC-SC3/SC4

%@0		
2 BINARY	2: Counter data type	(BINARY or BCD)
3 NO	3: Presence or absence of operator panel	(Presence: YES, Absence: NO)
4 PMC-RC3	4: PMC type	(PMC-RC3/PMC-RC4)
5 000000	5: Head address of language program link control statement data	(0 or 800000 to 8FFFFFF(hex))
6 50	6: Time ratio to execute language program	(1 to 99%)
7 100	7: Ladder execution time	(fixed at 100%)
%		

(4) For PMC-NB/NB2

%@0		
2 BINARY	2: Counter data type	(BINARY or BCD)
3 NO	3: Presence or absence of operator panel	(Presence: YES, Absence: NO)
4 PMC-NB	4: PMC type	(PMC-NB/PMC-NB2)
5 000000	5: Head address of language program link control statement data	(0 or 200000 to 2FFFFFF(hex))
6 50	6: Time ratio to execute language program	(1 to 99%)
7 100	7: Ladder execution time	(fixed at 100%)
%		

(5) For PMC-SB7

%@0		
2 BINARY	2: Counter data type	(BINARY or BCD)
3 NO	3: Presence or absence of operator panel	(Presence: YES, Absence: NO)
4 PMC-SB7	4: PMC type	(PMC-SB7)
7 150	7: Ladder execution time	
11 UNUSE	11: I/O link assignment selection function	(Used: USE, Not used: UNUSE) (channel 1)
12 0	12: Number of basic I/O link groups	(0 to 16) (channel 1)
13 UNUSE	13: I/O link assignment selection function	(Used: USE, Not used: UNUSE) (channel 2)
14 0	14: Number of basic I/O link groups	(0 to 16) (channel 2)
%		

(6) For 30i-A PMC (1st PMC)

%@0		
2 BINARY	2: Counter data type	(BINARY or BCD)
3 NO	3: Presence or absence of operator panel	(Presence: YES, Absence: NO)
4 30i-A PMC	4: PMC type	(30i-A PMC)
31 1	31: Number of display language (comment)	(1-16)
32 -1	32: CNC display language number 1	(-1, 0-127)
33 0	33: Comment set number 1	(0-16)
%		

(7) For 30i-A PMC (2nd PMC)

%@0		
2 BINARY	2: Counter data type	(BINARY or BCD)
3 NO	3: Presence or absence of operator panel	(Presence: YES, Absence: NO)
4 30i-A PMC(2nd)	4: PMC type	(30i-A PMC(2nd))
31 1	31: Number of display language (comment)	(1-16)
32 -1	32: CNC display language number 1	(-1, 0-127)
33 0	33: Comment set number 1	(0-16)
%		

(8) For 30i-A PMC (3rd PMC)

%@0		
2 BINARY	2: Counter data type	(BINARY or BCD)
3 NO	3: Presence or absence of operator panel	(Presence: YES, Absence: NO)
4 30i-A PMC(3rd)	4: PMC type	(30i-A PMC(3rd))
31 1	31: Number of display language (comment)	(1-16)
32 -1	32: CNC display language number 1	(-1, 0-127)
33 0	33: Comment set number 1	(0-16)
%		

(9) For 30i-A PMC (Dual check safety)

%@0		
2 BINARY	2: Counter data type	(BINARY or BCD)
3 NO	3: Presence or absence of operator panel	(Presence: YES, Absence: NO)
4 30i-A PMC(DCS)	4: PMC type	(30i-A PMC(DCS))
31 1	31: Number of display language (comment)	(1-16)
32 -1	32: CNC display language number 1	(-1, 0-127)
33 0	33: Comment set number 1	(0-16)
%		

NOTE

Please refer to Subsection 3.10.1 "Operation" of Section 3.10 "EDITING SYSTEM PARAMETERS" for the detail.

(10) For 31i-A PMC (1st-path PMC)

%@0		
2 BINARY	2: Counter data type	(BINARY or BCD)
3 NO	3: Presence or absence of operator panel	(Presence: YES, Absence: NO)
4 31i-A PMC	4: PMC type	(31i-A PMC)
31 1	31: Number of display language (comment)	(1-16)
32 -1	32: CNC display language number 1	(-1, 0-127)
33 0	33: Comment set number 1	(0-16)
%		

(11) For 31i-A PMC (2nd-path PMC)

%@0		
2 BINARY	2: Counter data type	(BINARY or BCD)
3 NO	3: Presence or absence of operator panel	(Presence: YES, Absence: NO)
4 31i-A PMC(2nd)	4: PMC type	(31i-A PMC(2nd))
31 1	31: Number of display language (comment)	(1-16)
32 -1	32: CNC display language number 1	(-1, 0-127)
33 0	33: Comment set number 1	(0-16)
%		

(12) For 31i-A PMC (3rd-path PMC)

%@0		
2 BINARY	2: Counter data type	(BINARY or BCD)
3 NO	3: Presence or absence of operator panel	(Presence: YES, Absence: NO)
4 31i-A PMC(3rd)	4: PMC type	(31i-A PMC(3rd))
31 1	31: Number of display language (comment)	(1-16)
32 -1	32: CNC display language number 1	(-1, 0-127)
33 0	33: Comment set number 1	(0-16)
%		

(13) For 31i-A PMC (Dual check safety)

%@0		
2 BINARY	2: Counter data type	(BINARY or BCD)
3 NO	3: Presence or absence of operator panel	(Presence: YES, Absence: NO)
4 31i-A PMC(DCS)	4: PMC type	(31i-A PMC(DCS))
31 1	31: Number of display language (comment)	(1-16)
32 -1	32: CNC display language number 1	(-1, 0-127)
33 0	33: Comment set number 1	(0-16)
%		

(14) For 31i-A PMC (1st-path PMC, Extended function)

%@0		
2 BINARY	2: Counter data type	(BINARY or BCD)
3 NO	3: Presence or absence of operator panel	(Presence: YES, Absence: NO)
4 31i-A PMC(EXT)	4: PMC type	(31i-A PMC(EXT))
31 1	31: Number of display language (comment)	(1-16)
32 -1	32: CNC display language number 1	(-1, 0-127)
33 0	33: Comment set number 1	(0-16)
%		

(15) For 31i-A PMC (2nd-path PMC, Extended function)

%@0		
2 BINARY	2: Counter data type	(BINARY or BCD)
3 NO	3: Presence or absence of operator panel	(Presence: YES, Absence: NO)
4 31i-A PMC(2nd,EXT)	4: PMC type	(31i-A PMC(2nd, EXT))
31 1	31: Number of display language (comment)	(1-16)
32 -1	32: CNC display language number 1	(-1, 0-127)
33 0	33: Comment set number 1	(0-16)
%		

(16) For 31i-A PMC (3rd-path PMC, Extended function)

%@0		
2 BINARY	2: Counter data type	(BINARY or BCD)
3 NO	3: Presence or absence of operator panel	(Presence: YES, Absence: NO)
4 31i-A PMC(3rd)	4: PMC type	(31i-A PMC(3rd, EXT))
31 1	31: Number of display language (comment)	(1-16)
32 -1	32: CNC display language number 1	(-1, 0-127)
33 0	33: Comment set number 1	(0-16)
%		

(17) For 31i-A PMC (Dual check safety, Extended function)

%@0		
2 BINARY	2: Counter data type	(BINARY or BCD)
3 NO	3: Presence or absence of operator panel	(Presence: YES, Absence: NO)
4 31i-A PMC(DCS,EXT)	4: PMC type	(31i-A PMC(DCS, EXT))
31 1	31: Number of display language (comment)	(1-16)
32 -1	32: CNC display language number 1	(-1, 0-127)
33 0	33: Comment set number 1	(0-16)
%		

(18) For 32i-A PMC (1st-path PMC)

%@0		
2 BINARY	2: Counter data type	(BINARY or BCD)
3 NO	3: Presence or absence of operator panel	(Presence: YES, Absence: NO)
4 32i-A PMC	4: PMC type	(32i-A PMC)
31 1	31: Number of display language (comment)	(1-16)
32 -1	32: CNC display language number 1	(-1, 0-127)
33 0	33: Comment set number 1	(0-16)
%		

(19) For 32i-A PMC (2nd-path PMC)

%@0		
2 BINARY	2: Counter data type	(BINARY or BCD)
3 NO	3: Presence or absence of operator panel	(Presence: YES, Absence: NO)
4 32i-A PMC(2nd)	4: PMC type	(32i-A PMC(2nd))
31 1	31: Number of display language (comment)	(1-16)
32 -1	32: CNC display language number 1	(-1, 0-127)
33 0	33: Comment set number 1	(0-16)
%		

(20) For 32i-A PMC (3rd-path PMC)

%@0		
2 BINARY	2: Counter data type	(BINARY or BCD)
3 NO	3: Presence or absence of operator panel	(Presence: YES, Absence: NO)
4 32i-A PMC(3rd)	4: PMC type	(32i-A PMC(3rd))
31 1	31: Number of display language (comment)	(1-16)
32 -1	32: CNC display language number 1	(-1, 0-127)
33 0	33: Comment set number 1	(0-16)
%		

(21) For 32i-A PMC (Dual check safety)

%@0		
2 BINARY	2: Counter data type	(BINARY or BCD)
3 NO	3: Presence or absence of operator panel	(Presence: YES, Absence: NO)
4 32i-A PMC(DCS)	4: PMC type	(32i-A PMC(DCS))
31 1	31: Number of display language (comment)	(1-16)
32 -1	32: CNC display language number 1	(-1, 0-127)
33 0	33: Comment set number 1	(0-16)
%		

(22) For 32i-A PMC (1st-path PMC, Extended function)

%@0		
2 BINARY	2: Counter data type	(BINARY or BCD)
3 NO	3: Presence or absence of operator panel	(Presence: YES, Absence: NO)
4 32i-A PMC(EXT)	4: PMC type	(32i-A PMC(EXT))
31 1	31: Number of display language (comment)	(1-16)
32 -1	32: CNC display language number 1	(-1, 0-127)
33 0	33: Comment set number 1	(0-16)
%		

(23) For 32i-A PMC (2nd-path PMC, Extended function)

%@0		
2 BINARY	2: Counter data type	(BINARY or BCD)
3 NO	3: Presence or absence of operator panel	(Presence: YES, Absence: NO)
4 32i-A PMC(2nd,EXT)	4: PMC type	(32i-A PMC(2nd, EXT))
31 1	31: Number of display language (comment)	(1-16)
32 -1	32: CNC display language number 1	(-1, 0-127)
33 0	33: Comment set number 1	(0-16)
%		

(24) For 32i-A PMC (3rd-path PMC, Extended function)

%@0		
2 BINARY	2: Counter data type	(BINARY or BCD)
3 NO	3: Presence or absence of operator panel	(Presence: YES, Absence: NO)
4 32i-A PMC(3rd)	4: PMC type	(32i-A PMC(3rd, EXT))
31 1	31: Number of display language (comment)	(1-16)
32 -1	32: CNC display language number 1	(-1, 0-127)
33 0	33: Comment set number 1	(0-16)
%		

(25) For 32i-A PMC (Dual check safety, Extended function)

%@0		
2 BINARY	2: Counter data type	(BINARY or BCD)
3 NO	3: Presence or absence of operator panel	(Presence: YES, Absence: NO)
4 32i-A PMC(DCS,EXT)	4: PMC type	(32i-A PMC(DCS, EXT))
31 1	31: Number of display language (comment)	(1-16)
32 -1	32: CNC display language number 1	(-1, 0-127)
33 0	33: Comment set number 1	(0-16)
%		

NOTE

Please refer to Subsection 3.10.1 "Operation" of Section 3.10 "EDITING SYSTEM PARAMETERS" for the detail.

6.4.2 Title

```

%@1
01 MACHINE TOOL BUILDER NAME
02 MACHINE TOOL NAME
03 CNC & PMC NAME
04 PMC PROGRAM NO.
05 EDITION NO.
06 PROGRAM DRAWING NO.
07 DATE OF PROGRAMMING
08 PROGRAM DESIGNED BY
09 ROM WRITTEN BY
10 REMARKS
%
    
```

6.4.2.1 Symbol and comment

%2-C

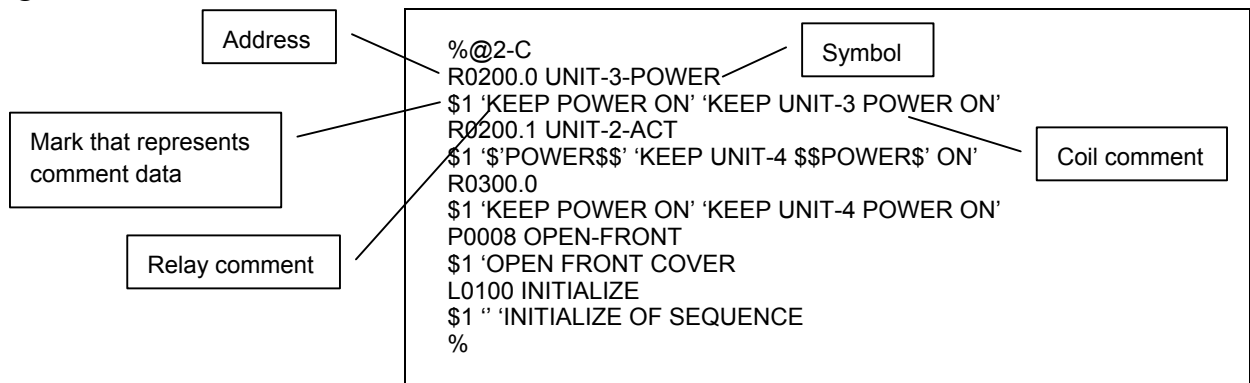

NOTE

- 1 Symbol is up to 16 characters (bytes).
- 2 Relay comment is up to 16 characters (bytes).
- 3 Comment is up to 30 characters (bytes).

%2-C2

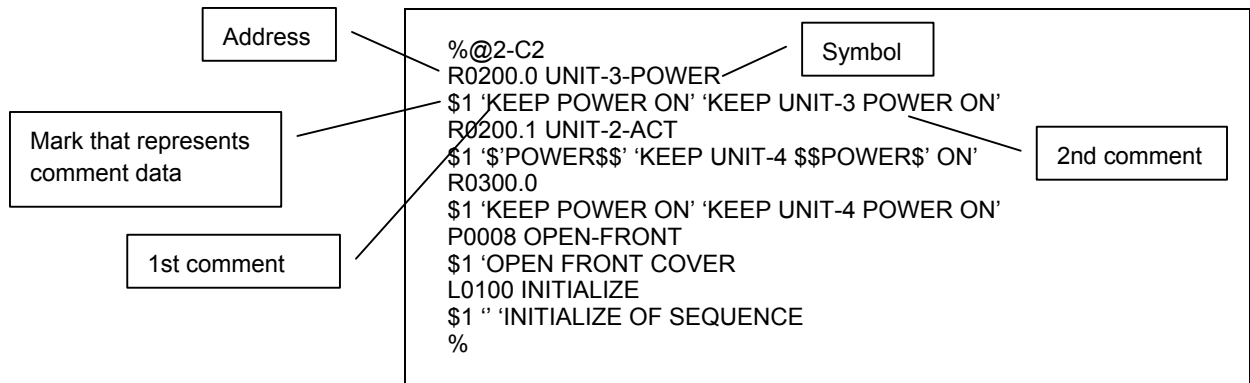

NOTE

- 1 Symbol is up to 16 characters (bytes).
- 2 First Comment and second comment are up to 30 characters (bytes).

6.4.2.2 Ladder

P-G compatible and Japanese comment

```

%@3
RD X0.4
OR Y80.6
WRT D300.1
SUB 1
RD.NOT X3.0
SUB 40
2
8191
D300
SUB 2
%
```

Full option

```

%@3
N00001: SUB 71 ; SP
          P1 ; (SUBPR1 ) "SUB PROG. NO.01"
          ; [SUB PROGRAM DATA NO.01]
N00002: RD X0.0 ; (XADRS1 ) "JUMPB LABEL L001"
          SUB 68 ; JMPB
          L100 ; (LABEL1 )
          ; [LABEL L00001]
N00003: RD X0.1 ; (XADRS2 ) "JMPC LABEL L001"
          SUB 73 ; JMPC
          L100 ; (LABEL1 )
          ; [LABEL L00001]
N00004: SUB 69 ; LBL
          L100 ; (LABEL1 )
          ; [LABEL L00001]
N00005: SUB 72 ; SPE
N00006: SUB 71 ; SP
          P2 ; (SP1000 ) "SUB PROGRAM NO.1"
N00007: RD R0.0 ; (RADRS00)
          DEC D0 ; (DADRS04)
          2
          WRT D0.0
N00008: SUB 72 ; SPE
N00009: SUB 64 ; END
%
```

Label and subprogram

```

%@3
SUBPR1  SP      SUBPR1  ; <P1 > "SUB PROG. NO.01"
          ; [SUB PROGRAM DATA NO.01]
          RD      XADRS1  ; <X0.0 > "JUMPB LABEL L001"
          JMPB    LABEL1  ; <L100 >
          ; [LABEL L00001]
          RD      XADRS2  ; <X0.1 > "JUMPB LABEL L002"
          JMPB    LABEL1  ; <L100 > [LABEL L00001]
LABEL1  LBL
          ; <L100 >
          ; [LABEL L00001]
          SPE
SP1000  SP      ; <P2 > "SUB PROG. NO.01"
          RD      RADR00  ; <R0.0 >
          DEC     DADR04  ; <D0 >
          2
          WRT     D0.0
          SPE
          END
%
```

6.4.2.3 Message

```

%@4
A00.0 2100020 ACT DOOR NOT CLOSE
A00.1 2101022 SPINDLE SPEED ARRIVAL SIGNAL NOT ON
A00.2 2100020 EDTOK KEY SWITCH ON
%
```

6.4.2.4 I/O module

```

%@5
X000 1 0 1 ID64A
Y008 1 0 4 OD64B
%
```

6.4.3 ALL format

```

%@A
%@0
2 BINARY
3 NO
4 PMC-RB4
%
%@1
01 MACHINE TOOL BUILDER NAME
:
:
10 REMARKS
%
%@2-C
R0200.0 UNIT-3-POWER
$1 'KEEP POWER ON' 'KEEP UNIT-3 POWER ON'
R0200.1 UNIT-2-ACT
$1 '$POWER$$' 'KEEP UNIT-4 $$POWER$' ON'
R0300.0
$1 'KEEP POWER ON' 'KEEP UNIT-4 POWER ON'
P0008 OPEN-FRONT
$1 'OPEN FRONT COVER
L0100 INITIALIZE
$1 " 'INITIALIZE OF SEQUENCE
%
%@3
RD R1001.0
OR R120.3
AND R1000.2
WRT Y2000.4
(*
Describe a net comment at this position.
Any characters that can be entered from a PC are available.
*)
RD R1001.0
AND R1000.2
WRT Y23.4
(* $p *) ← Specification of the position of a form feed character (printing
a ladder diagram)
RD R101.0
OR R123.4
AND R100.2
WRT Y200.4
%
%@4
A00.0 2100020 ACT DOOR NOT CLOSE
A00.1 2101022 SPINDLE SPEED ARRIVAL SIGNAL NOT ON
%
%@5
X000 1 0 1 ID16C
Y008 1 0 4 OD32A
%
%@E

```

6.5 CONVERTING STEP SEQUENCE PROGRAMS TO MNEMONIC FILES

This section describes the procedure for converting a step sequence program to a mnemonic file. Use this function only when you change a conventional model to a new model.

Procedure

1. Modify a mnemonic option definition in the %%%FLSET file in the FANUC LADDER-III installation folder, using a text editor.

```
=====
;      FANUC LADDER-III Initial Setting File
;
;      ( `key word =' <= 9characters )
;
=====
;
~~~
*M;      ===== Mnemonic options definition =====
;
P_G_COMPATIBLE = /ERC FLMNE.ERR /OUT V /P-G
JPN_COMMENT = /ERC FLMNE.ERR /OUT V /SJ /MJJ /ICH
JPN_FULL_OPTIONS = /ERC FLMNE.ERR /OUT V /LX 8 20 28 /SJ /LS /LC /LF /LN /MJJ /ICH
ENG_FULL_OPTIONS = /ERC FLMNE.ERR /OUT V /LX 8 20 28 /LS /LC /LF /LN /ICH
JPN_LABEL_SUBPRG = /ERC FLMNE.ERR /OUT V /LX 10 21 31 /SJ /LAD /LC /LLS /LAS /LS /LFN /MJJ /ICH
ENG_LABEL_SUBPRG = /ERC FLMNE.ERR /OUT V /LX 10 21 31 /LAD /LC /LLS /LAS /LS /LFN /ICH
;
```

SFC=1; ← When you want to convert a step sequence program to a mnemonic file or source program, set 1.

2. Select [Tool] - [Mnemonic Convert...]. The [Mnemonic] dialog box appears. In this dialog box, convert a step sequence program to a mnemonic file.

NOTE

- 1 Do not edit a step sequence program converted to a mnemonic file using a text editor.
- 2 If you re-install the FANUC LADDER-III, the content of “%%FLSET” file is replaced with initial value.

6.6 MNEMONIC OPTIONS

A specified character is separate in “Conversion into a mnemonic file” and “Conversion into the source program”. And the replacement of the white-space character is selectable on the mnemonic option dialog-box ([Tool] – [Option - Mnemonic/Source]).

A specified character is:

The white-space character is treated as a separate character in a mnemonic file. When converting the source program into a mnemonic file, it is possible to replace the white-space character in the symbol with another character. The replaceable character is described as “A specified character”.

When converting a mnemonic file into the source program, it is possible to replace the white-space character with a specified character.

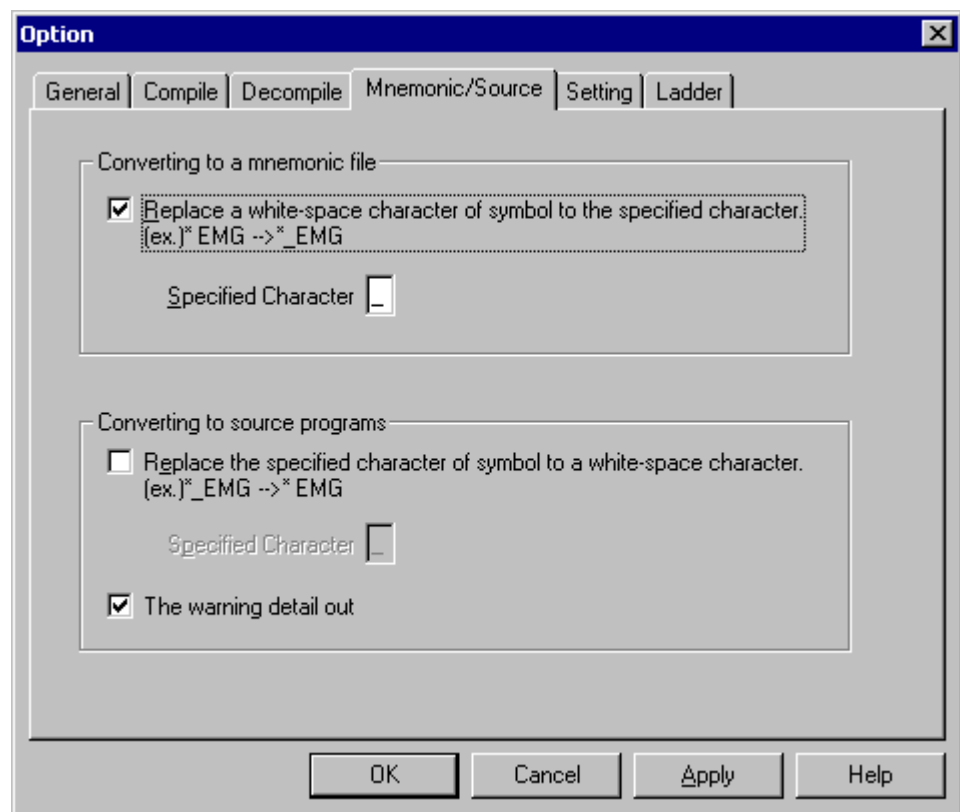

Fig. 6.6

Converting to a mnemonic file

To replace the white-space character with another character when converting to a mnemonic files, please check [Replace a white-space character of symbol to the specified character]. (Default: checked on)

When this box is not checked, the white-space characters in a symbol are output to a mnemonic file without being replaced.

Enter the replacing character in the [Specified Character] edit box (one half-size character).

Converting to source programs

To replace the specified character with the white-space character when converting to source programs, please check [Replace the specified character of symbol to a white-space character]. (Default: checked off)

When this box is not checked, the specified characters in a symbol are output to a symbol data without being replaced.

Enter the replacing character in the [Specified Character] edit box (one half-size character).

6.7 FORMAT OF EXTERNAL SYMBOL FILE

Mnemonic file format is enhanced to read a normal CSV file.

Identification code

For a mnemonic file, data is defined using one of four types of identification code, being with %.

Please use identification code “%@2-E” when you describe symbol information in the CSV file.

Table 6.7

Identification code	Meaning
%@A	Start of ALL-format data
%@E	End of ALL-format data
%@0 to %@5	Start of each single-format data %@0: System parameter %@1: Title %@2: Symbol and comment (FORMAT-A/B) %@2-C: Symbol and comment (FORMAT-C) %@2-C2: Symbol and comment (Multiple comment) %@2-D: Symbol and comment (Variable symbol) %@2-E (Option): Symbol and comment (CSV file) %@3: Ladder %@3-D: Ladder (Variable symbol) %@4: Message %@5: I/O module
Only %	End of each single-format data

The column number of symbol, comment and etc. is specified for Option enclosed in parentheses behind %@2-E.

6.7.1 Option

The column number of symbol, comment and etc. is specified for Option enclosed in parentheses behind %@2-E.

Table 6.7.1

Option	Description	Remarks
/SYM=	Specify a column no. of symbol	1st column when omitted
/SCP=	Specify a column no. of symbol scope (LEVEL1->L1, LEVEL2->L2, P0001->P1,,).	Symbol scope is global when omitted
/TYP=	Specify a column no. of symbol type (BOOL/BYTE/WORD/DWORD)	3rd column when omitted
/ADR=	Specify a column no. of address	4th column when omitted
/CM1=	Specify a column no. of comment 1	When omitted, it is considered that comment 1/2/3/4 does not exist. In Additional Information window of CNC's I/O DIAGNOSIS screen, one of 4 comments can be displayed according to the setting of display language on CNC. Please see "11.7.1 Set of display language for comment" in this material.
/CM2=	Specify a column no. of comment 2	
/CM3=	Specify a column no. of comment 3	
/CM4=	Specify a column no. of comment 4	
/SEP=	Specify a character of delimiter	Delimiter is comma when omitting
+	Plus is used to connect strings of two or more comment columns	To combine the character strings in the fifth column and the tenth column into comment 1, specify CM1=5+10.
/JOI=	Specify a character to connect strings of two or more comment columns.	When /JOI=_ is specified, _ is added between character strings to be combined. When this option is omitted, they are directly combined.
/LBL	The first effective line is a column label definition line.	When /LBL exists, the conversion of the first line in effective data is skipped.
(white-space)	Delimiter of option setting	

(Ex.) Separator is comma, quotation mark is “, 1st column is symbol, 2nd column is address, 3rd column is type, 4th column is scope, 5th column is comment1 and 6th column is comment2.

%@2-E(SYM=1 ADR=2 TYP=3 SCP=4 CM1=5 CM2=6)

6.7.2 Sample of an External Symbol File

```

:
%@2-E(SYM=1 ADR=2 TYP=3 SCP=4 CM1=5 CM2=6)
STOP,Y0.0,BOOL,Stop signal on,Maintenance information (Line 29)
POWER_OFF,X32.0,BOOL,Power off status,Maintenance information (Line 01)
DOOR,X32.1,BOOL,Safety door open,Maintenance information (Line 12)
%
:

```

6.7.3 Operation to Import from CSV-file

It is possible to import symbol/comment data by the same procedure as a source program conversion.

Procedure

1. Boot FANUC LADDER-III. And then create or open a LAD file.
2. Select [Tool] – [Source Program Convert...]. Then, the [Mnemonic – Source Program Conversion] dialog appears.

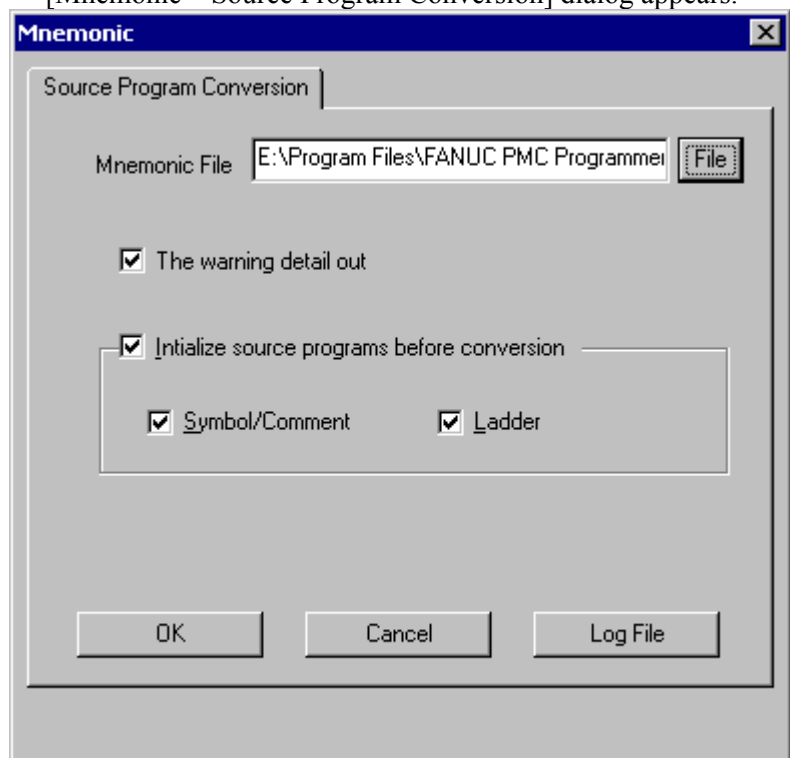

Fig. 6.7.3

3. Input the CSV-file name to be imported into [Mnemonic File] edit-box.
4. If you want to initialize symbol/comment data before importing, please check [Initialize source programs before conversion] and [Symbol/Comment].
5. To import symbol/comment data from a CSV-file, click the <OK> button.

NOTE

When converting from the source file to mnemonic file, symbol/comment data is always exported in normal symbol/comment format (%@2-D section format). It is not supported to export CSV format symbol/comment file.

6.7.3.1 Batch Command Execution

To import symbol/comment data from CSV-file, please use “MnemonicToSrc” command.

And please specify the CSV-file name into the *filename* of “MnemonicToSrc” command.

Example of batch command execution

- (1) Add symbol/comment data from CSV-file.

```
>cd d:\%mnemonic
>start /wait fladder.exe /cmdfile=fl3_command1.txt
>start fladder.exe M_0123.LAD
```

fl3_command1.txt

```
FIOpen M_0123.LAD
MnemonicToSrc /file=003_P1LocalSymbol.csv
FIClose
End
```

- (2) Read symbol information from three CSV files, after symbol information on the source program is initialized,

```
>cd d:\%mnemonic
>start /wait fladder.exe /cmdfile=fl3_command2.txt
>start fladder.exe M_0123.LAD
```

fl3_command2.txt

```
FIOpen M_0123.LAD
MnemonicToSrc /file=003_GlobalSymbol.csv /init=3
MnemonicToSrc /file=003_L1LocalSymbol.csv
MnemonicToSrc /file=003_L2LocalSymbol.csv
FIClose
End
```

7

INPUT/OUTPUT

This chapter describes how to load and store programs.

NOTE

- 1 When input or output (loading data from the PMC or storing data to the PMC) is performed during NC operation, the speed at which data (such as positions) is displayed on an NC screen may fall. This does not, however, affect NC operation. It is recommended that input or output be performed while the NC is not being operated.
- 2 While a screen created by the C language executor is displayed, the communication speed falls. It is recommended that, after moving to another screen such as the position display screen, input or output (loading data from the PMC or storing data to the PMC) be performed.

7.1 SETTING UP COMMUNICATION

This section describes how to set up communication required for editing a program in online mode and for input/output operations.

7.1.1 [Communication] Dialog Box

This subsection describes how to set items related to communication in the [Communication] dialog box.

7.1.1.1 Setting up RS-232C

Procedure

1. Select [Tool] - [Communication...] to display the [Communication] dialog box.

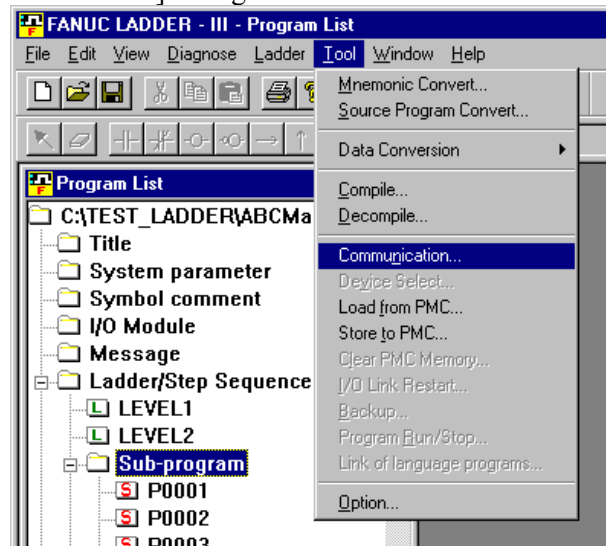

Fig. 7.1.1.1(a)

2. Select the [Setting] tab and a communication port you want to use from [Enable device] and click the <Add> button.

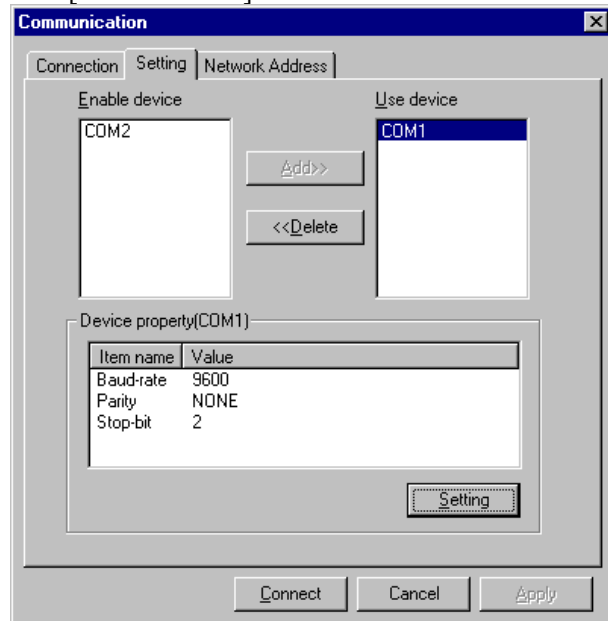

Fig. 7.1.1.1(b)

3. Select the added communication port and click the <Setting> button.
Set each item in [Communication parameter].

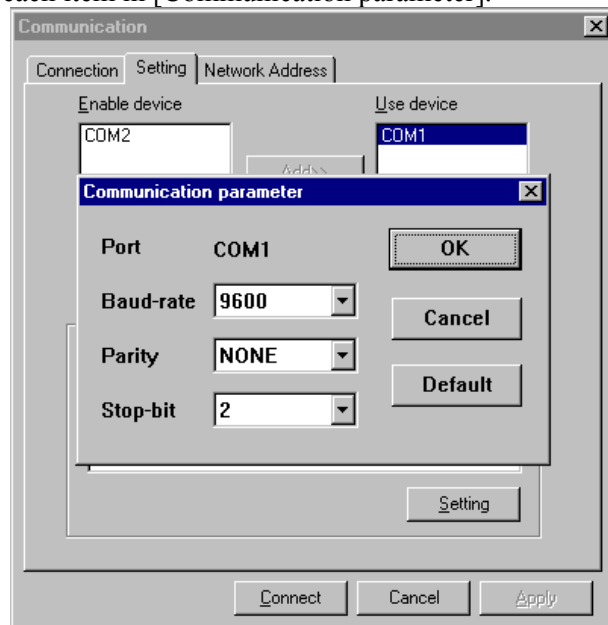

Fig. 7.1.1.1(c)

4. Set the values according to values set for the PMC online monitor function.

Baud-rate

Specify the baud rate. (300 to 19200 bps)

Parity

Specify the parity bit.

Stop-bit

Specify the stop bit.

Default

Initializes the settings to their default values.

5. Click the <OK> button to make the settings take effect.

7.1.1.2 Setting up Ethernet

Procedure

1. Select [Tool] - [Communication...] to display the [Communication] dialog box.
2. Select the [Network Address] tab and click the <Add Host> button. Click the <Advanced> button to display [Host Setting Dialog].

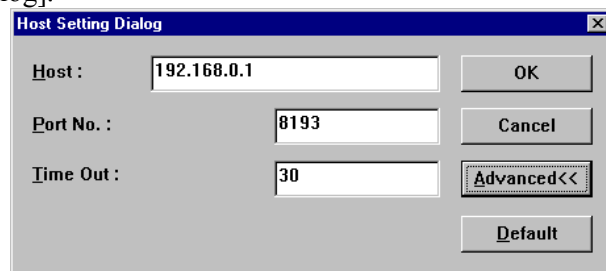

Fig. 7.1.1.2(a)

Host

Specify a host name (for example, "CNC1") or an IP address (for example, "190.168.0.1").

Port No.

Specify the port number of the Ethernet function of the CNC to be connected.

Time Out

Specify the time out applied to the transmission/reception of PMC data, in seconds.

3. Select [Setting] and add a network address to "Use device".

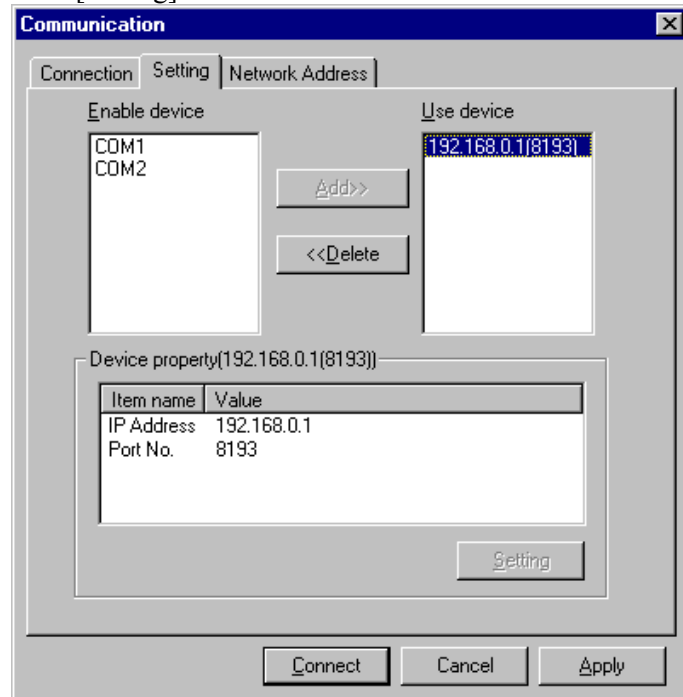

Fig. 7.1.1.2(b)

4. Click the <Connect> button to start communication.

NOTE

If the PMC is displaying one of the following screens, you cannot communicate with the PMC. Use the online function after the PMC switches to another screen.

[PMCLAD], [I/O], [EDIT], [SYSPRM], [TRACE],
 [ANALYS], [USRDGN], [DBGLAD], [GDT],
 [USRMEM]

7.1.2 [Option] Dialog Box

This subsection describes how to set items related to communication in the [Option] dialog box.

7.1.2.1 Setting up RS-232C

Procedure

1. Select [Tool] - [Option].

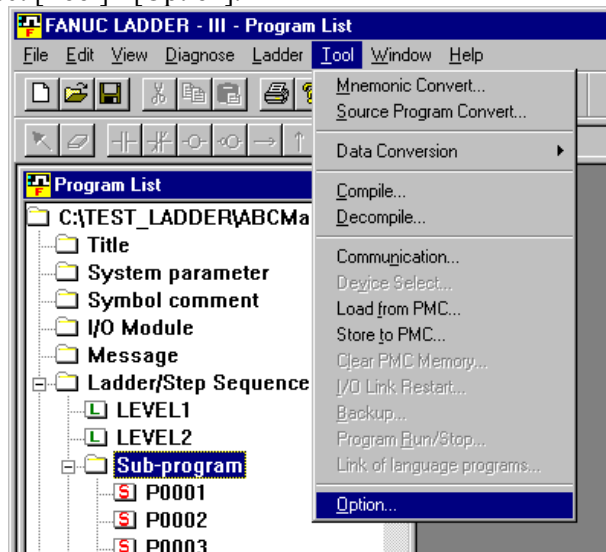

Fig. 7.1.2.1(a)

2. Select the [Setting] tab and a communication port you want to use from [Use device] and click the <Add> button.

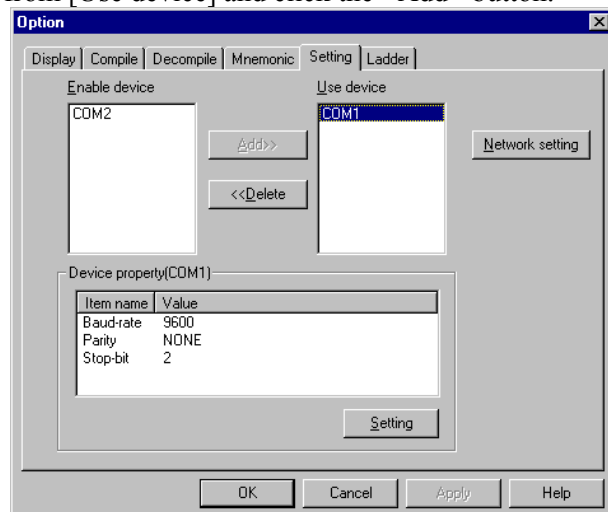

Fig. 7.1.2.1(b)

3. Select the added communication port and click the <Setting> button.
Set each item in [Communication parameter].
4. Set the values according to the procedure described in Subsection 7.1.1.1, "Setting up RS-232C."

7.1.2.2 Setting up Ethernet

1. Select the [Setting] tab and click the <Network setting> button. In the [Network setting] dialog box, click the <Add Host> button and then the <Advanced> button to display [Host Setting Dialog].

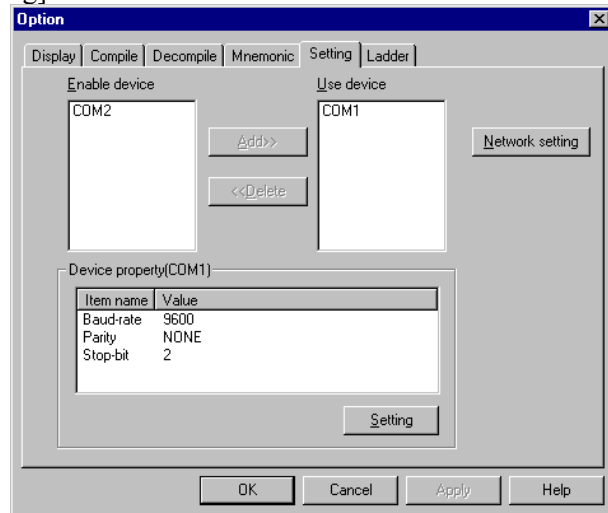

Fig. 7.1.2.2(a)

2. Set the values according to the procedure described in Subsection 7.1.1.2, "Setting up Ethernet."

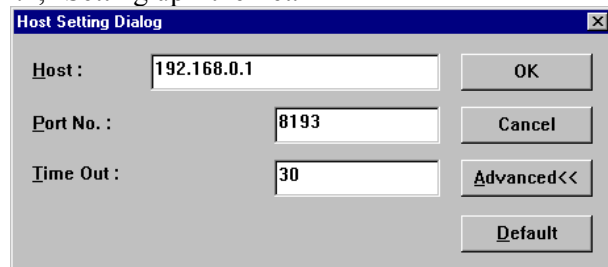

Fig. 7.1.2.2(b)

7.2 LOADING SEQUENCE PROGRAMS FROM THE PMC (DURING DISCONNECTION WITH THE PMC)

7.2.1 Procedure

- 1 Select [File] - [Open Program] to open the program into which data is to be loaded.
- 2 Select [Tool] - [Load from PMC].
The [Program transfer wizard Selection of transferred method] screen appears.

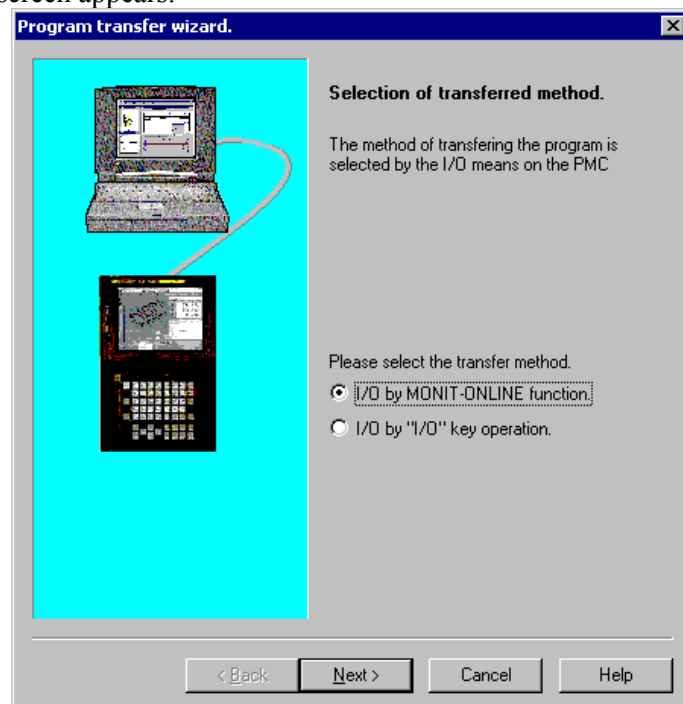

Fig. 7.2.1(a)

- 2-1 Select a transfer method.
 - <I/O by MONIT-ONLINE function>
A communication function by an online monitor is used.
 - <I/O by "I/O" key operation>
Input or output is performed by the HOST operation of an I/O function.

NOTE

On PMC-SB7 and 30i/31i/32i-A PMC, this screen does not appear. On PMC-SB7 and 30i/31i/32i-A PMC, only <I/O by MONIT-ONLINE function> is available.

◆ <I/O by MONIT-ONLINE function>

- 3 Select <I/O by MONIT-ONLINE function>, and then click the <Next> button. The following message appears.

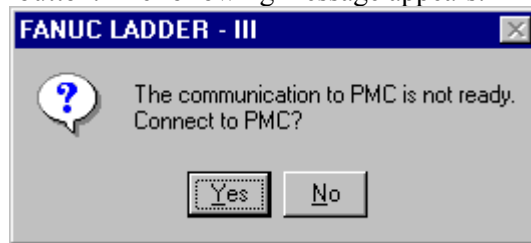

Fig. 7.2.1(b)

- 4 To display the [Communication] screen to start access to the PMC, click the <Yes> button.

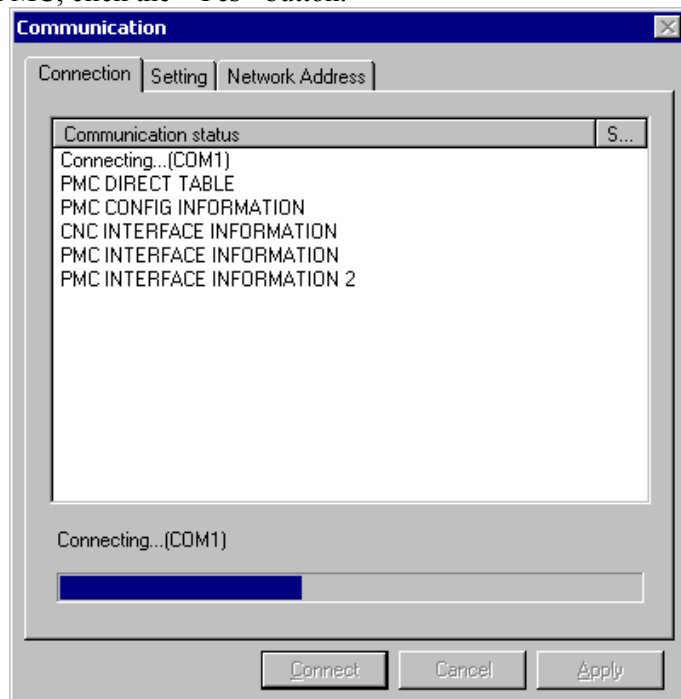

Fig. 7.2.1(c)

- 5 When there is a loader, the [Communication Current Device] screen appears. Select either CNC Main or LOADER, and then click the <Exec> button.

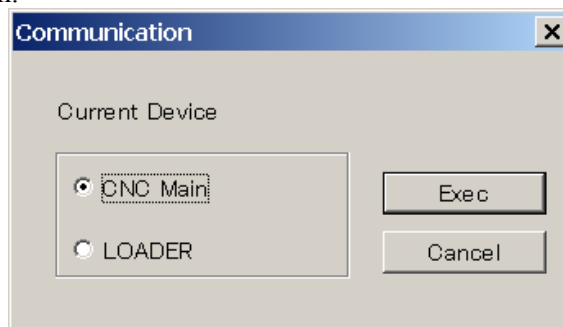

Fig. 7.2.1(d)

- 6 The [Program transfer wizard Selection of loading/store] screen appears. Click the <Next> button.

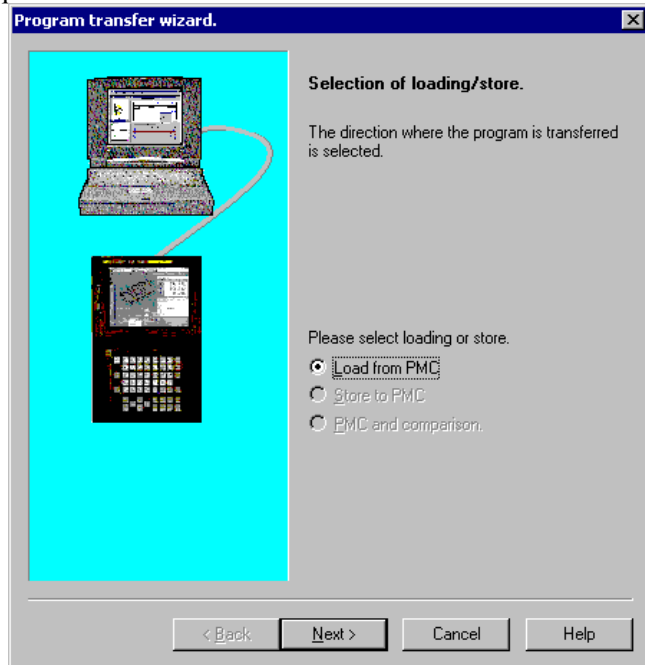

Fig. 7.2.1(e)

- 7 The [Program transfer wizard Selection of program] screen appears.

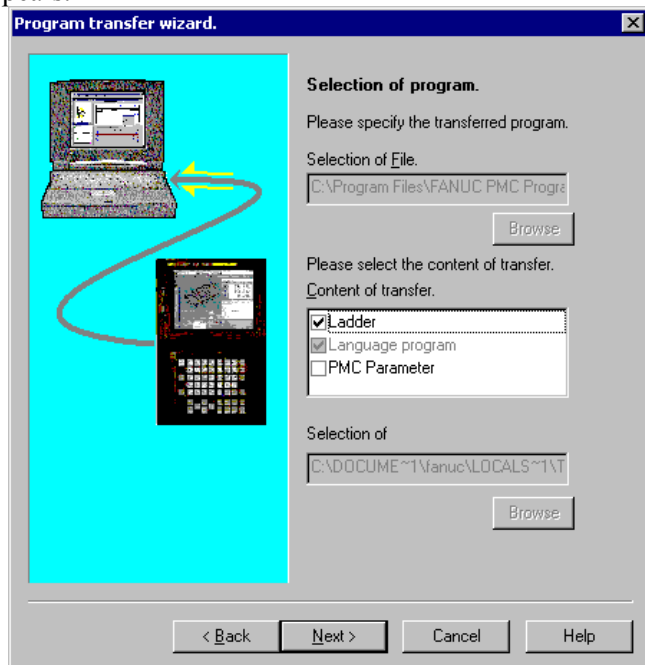

Fig. 7.2.1(f)

- 8 For the remainder of the procedure, see Section 7.3, "Loading Sequence Programs from the PMC (During Connection with the PMC)."

The PMC model of LAD file can be changed, when on-line connection to the same type is completed.

Model Ladder Type	Compatible PMC		
	30i-A	31i-A	32i-A
1st	30i-A PMC	↔	31i-A PMC ↔ 32i-A PMC
2nd	30i-A PMC(2nd)	↔	31i-A PMC(2nd) ↔ 32i-A PMC(2nd)
3rd	30i-A PMC(3rd)	↔	31i-A PMC(3rd) ↔ 32i-A PMC(3rd)
DCS	30i-A PMC(DCS)	↔	31i-A PMC(DCS) ↔ 32i-A PMC(DCS)
1st, EXT	30i-A PMC(EXT)	↔	31i-A PMC(EXT) ↔ 32i-A PMC(EXT)
2nd, EXT	30i-A PMC(2nd,EXT)	↔	31i-A PMC(2nd,EXT) ↔ 32i-A PMC(2nd,EXT)
3rd, EXT	30i-A PMC(3rd,EXT)	↔	31i-A PMC(3rd,EXT) ↔ 32i-A PMC(3rd,EXT)
DCS, EXT	30i-A PMC(DCS,EXT)	↔	31i-A PMC(DCS,EXT) ↔ 32i-A PMC(DCS,EXT)

↔ : Compatible memory card form file

Operation

1. Open the ladder program.
2. Select [Tool]-[Communication...]. Then, the [Communication] dialog appears.
3. Confirm the setting and click the <Connect> button.
4. Click the <Close> button if the connection is completed. Compatible PMC displays the following screen.

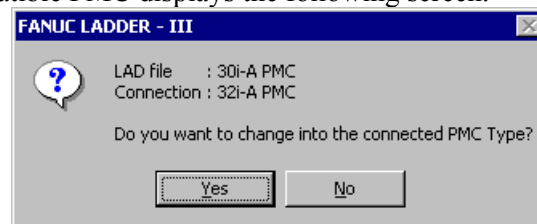

- If the <Yes> button is clicked, the model of LAD file is changed.
In the case of the above-mentioned example, the LAD file is changed into 32i-A.
- If the <No> button is clicked, the model of LAD file is not changed.
If the PMC model is not changed, you cannot operate the on-line ladder edit after connection. Switch programmer mode to on-line and off-line to operate on-line ladder edit. Then, change the model of LAD file.

NOTE

The sequence program for Series 30i-A can be executed in Series 31i/32i-A without conversion. But, do not execute the PMC sequence program in other CNC without debugging.

- ◆ <I/O by “I/O” key operation>
- 3 Select <I/O by “I/O” key operation>, and then click the <Next> button. The [Program transfer wizard Selection of loading/store] screen appears.

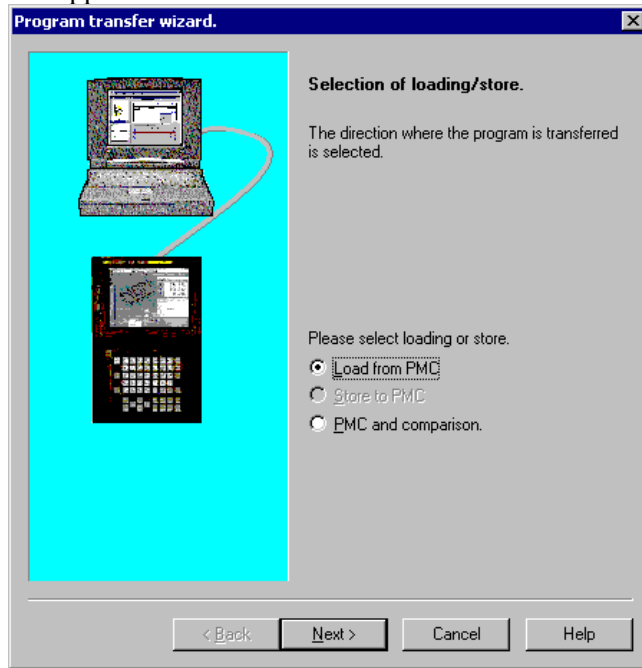

Fig. 7.2.1(g)

- 4 Click the <Next> button. The [Program transfer wizard Selection of program] screen appears.

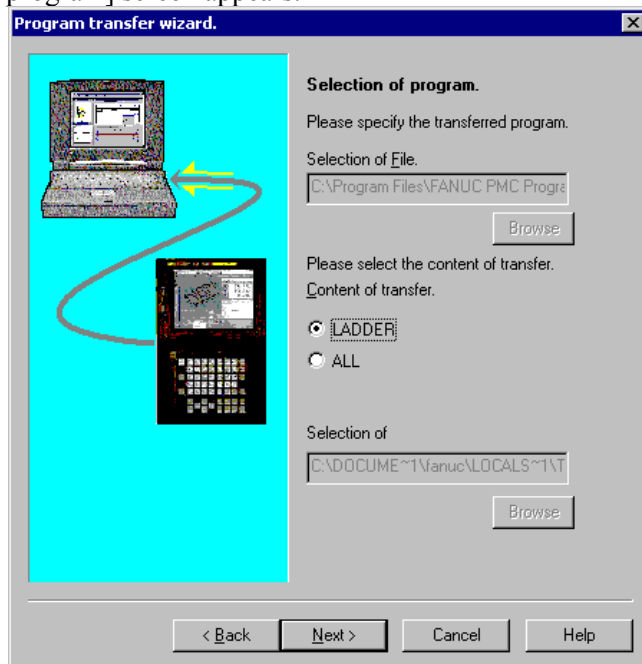

Fig. 7.2.1(h)

- 5 Select LADDER or ALL, and then click the <Next> button.

- 6 The [Program transfer wizard Setting of communication] screen appears.
Set a communication protocol, and then click the <Next> button.

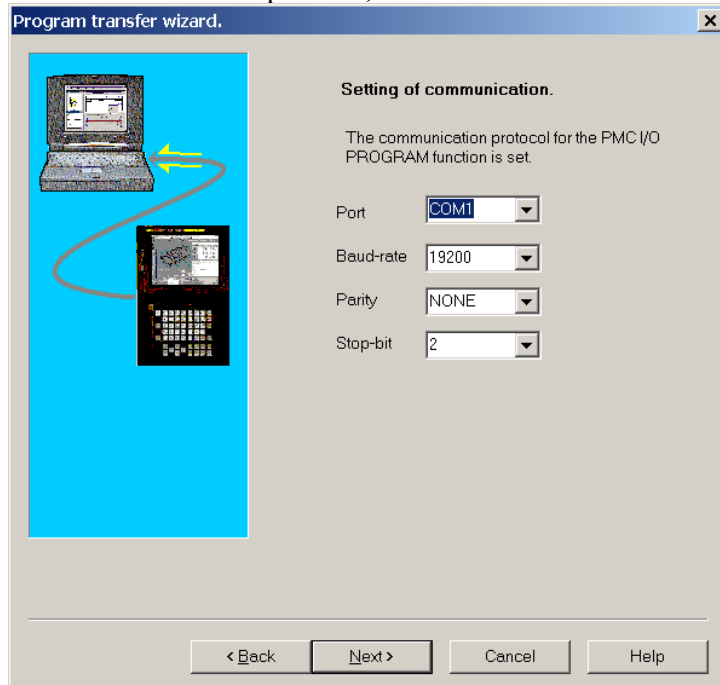

Fig. 7.2.1(i)

- 7 The [Program transfer wizard Confirmation of processing] screen appears.

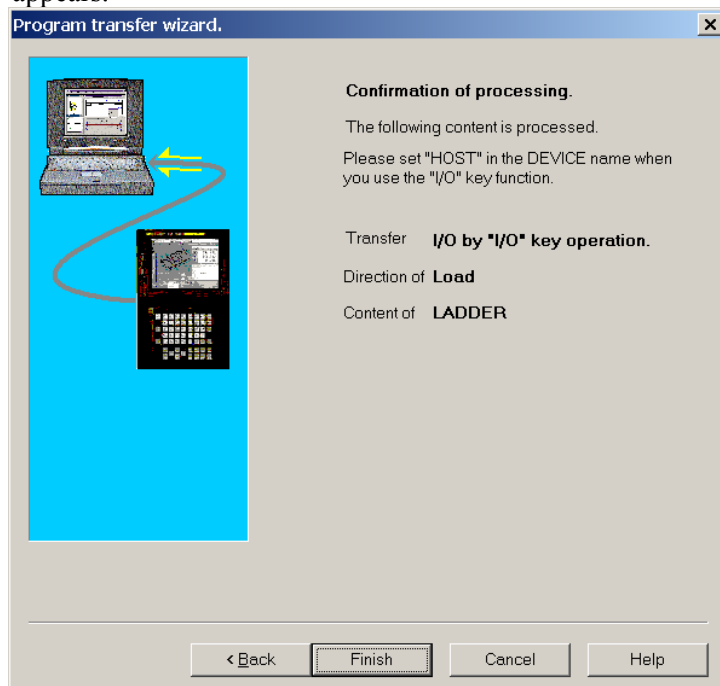

Fig. 7.2.1(j)

- 8 Click the <Finish> button. Then, the [Execution of I/O transfer] screen appears.

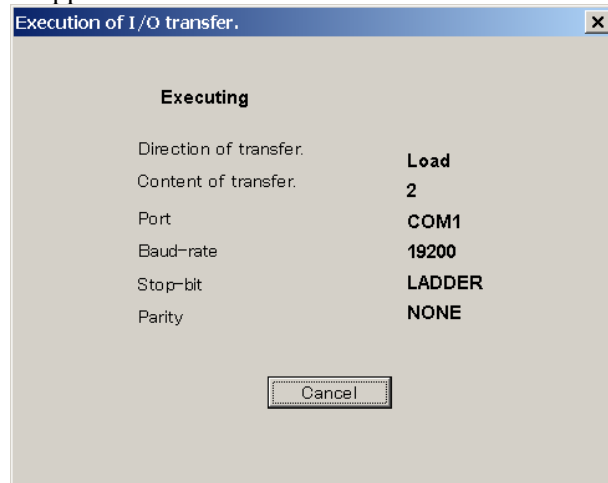

Fig. 7.2.1(k)

NOTE

Set CHANNEL, DEVICE, FUNCTION, and DATA KIND on the PMC I/O PROGRAM screen of the PMC in advance. Set HOST for DEVICE. For details of the settings, refer to the FANUC PMC Ladder Language Programming Manual (B-61863E).
Press soft key <EXEC> of the NC to place the NC in standby.

- 9 Once I/O transfer is complete, the following message appears.



Fig. 7.2.1(l)

7.3 LOADING SEQUENCE PROGRAMS FROM THE PMC (DURING CONNECTION WITH THE PMC)

7.3.1 Procedure

- 1 Select [File] - [Open Program] to open the program into which data is loaded.
- 2 Select [Tool] - [Load from PMC].
The [Program transfer wizard Selection of program] screen appears.

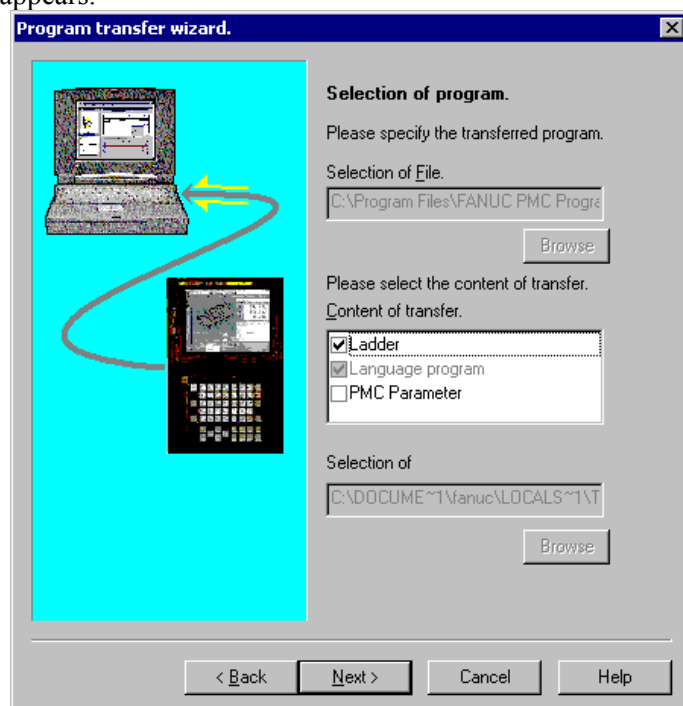

Fig. 7.3.1(a)

NOTE

When connection is not established, the [Communication] screen appears. Then, establish connection.

- 2-1 Set data.

Content of transfer

As transfer information, a selection can be made from Ladder, Language program, and PMC Parameter. When transferring PMC parameters, enter a transfer destination file name in [Selection of]. The initial setting specifies that PMC parameters are transferred to PMC_PRM.PRM in a user file folder.

For a user file folder, see Subsection 3.1.3, "Work Folders and Online Program Files."

A PMC parameter file once transferred to a user file folder can be restored by using the export function.
For the export function, see Section 3.15, "EXPORTING PROGRAMS."

NOTE

Only PMC-SC3/SC4 allow loading and storing of language programs. Those types of PMCs to which a C language board is attached do not allow loading and storing of language programs.

2-2 Click the <Next> button. The [Program transfer wizard Confirmation of processing] screen appears.

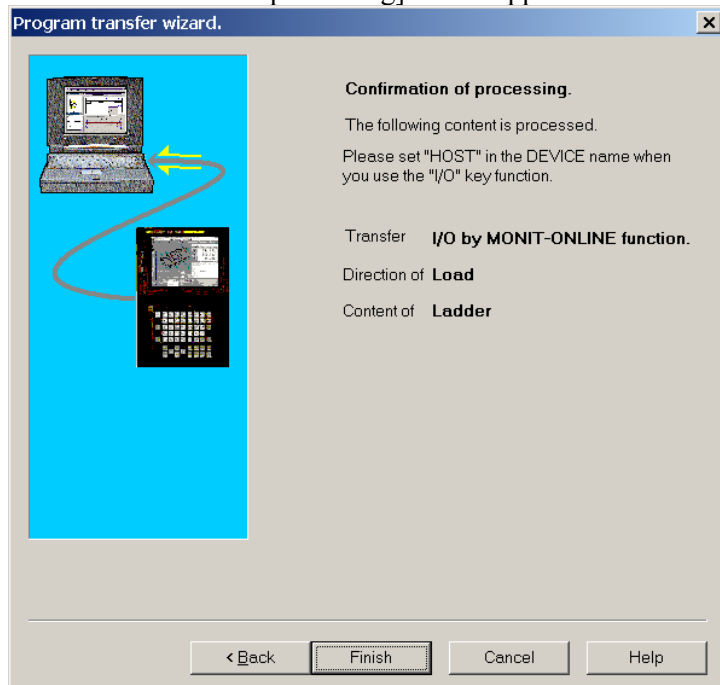

Fig. 7.3.1(b)

2-3 Check the setting items. Click the <Finish> button. Then, the [Transfer monitor] screen appears, and then the program is transferred.

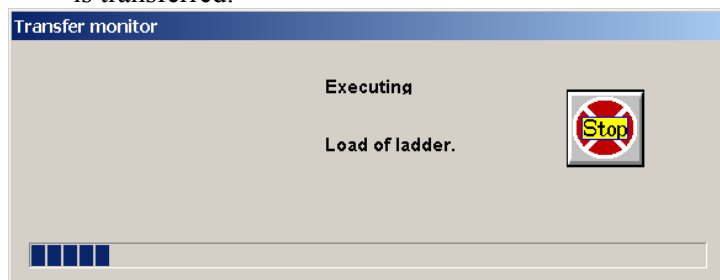

Fig. 7.3.1(c)

7.4 STORING SEQUENCE PROGRAMS IN THE PMC (DURING CONNECTION WITH THE PMC)

7.4.1 Procedure

- 1 Select [File] - [Open Program] to open the program to be stored.
- 2 Select [Tool] - [Store to PMC].
The [Program transfer wizard Selection of transferred method] screen appears.

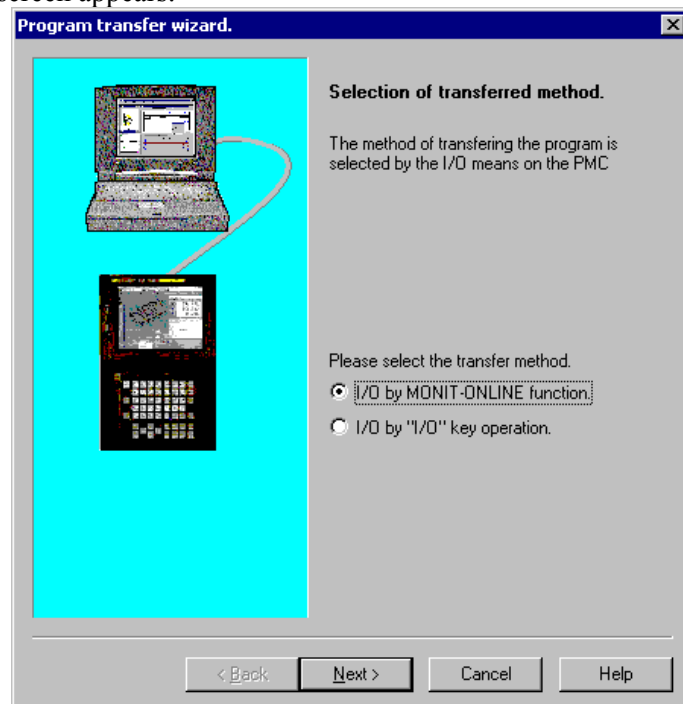

Fig. 7.4.1(a)

- 2-1 Selection of transferred method.
 - <I/O by MONIT-ONLINE function>
A communication function by an online monitor is used.
 - <I/O by "I/O" key operation>
An input or output is performed by the HOST operation of an I/O function.

◆ <I/O by MONIT-ONLINE function>

- 3 Select <I/O by MONIT-ONLINE function>, and then click the <Next> button. The following message appears.

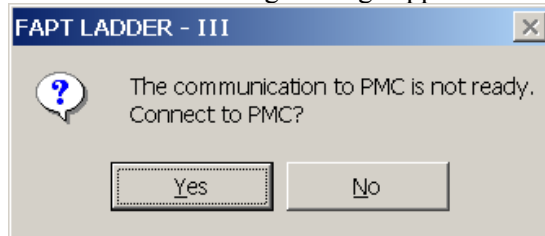

Fig. 7.4.1(b)

- 4 Click the <Yes> button. The [Communication] screen appears, after which access to the PMC is started.

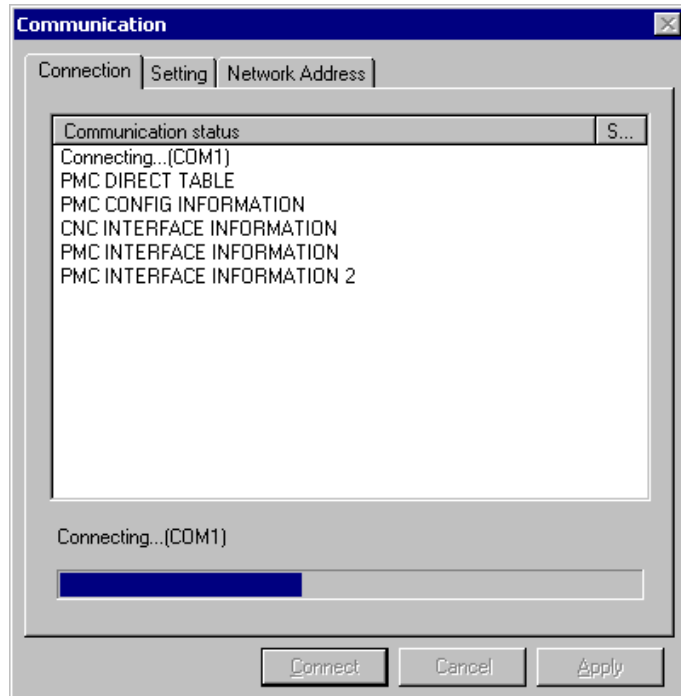

Fig. 7.4.1(c)

- 5 When there is a loader, the [Communication Current Device] screen appears. Select CNC Main or LOADER, and then click the <Exec> button.

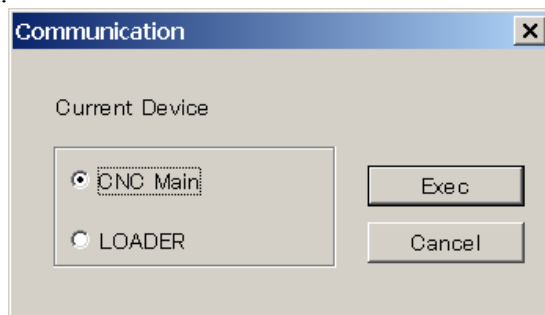

Fig. 7.4.1(d)

- 6 The [Program transfer wizard Selection of loading/store] screen appears. Click the <Next> button.

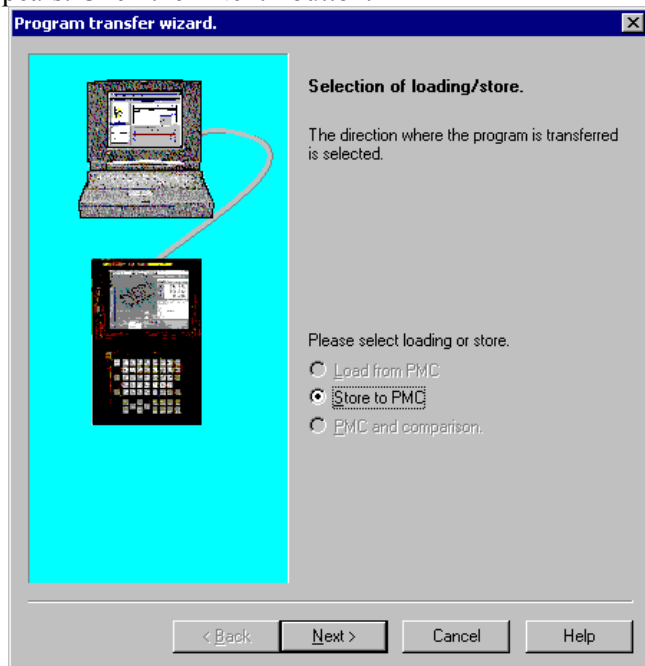

Fig. 7.4.1(e)

- 7 The [Program transfer wizard Selection of program] screen appears.

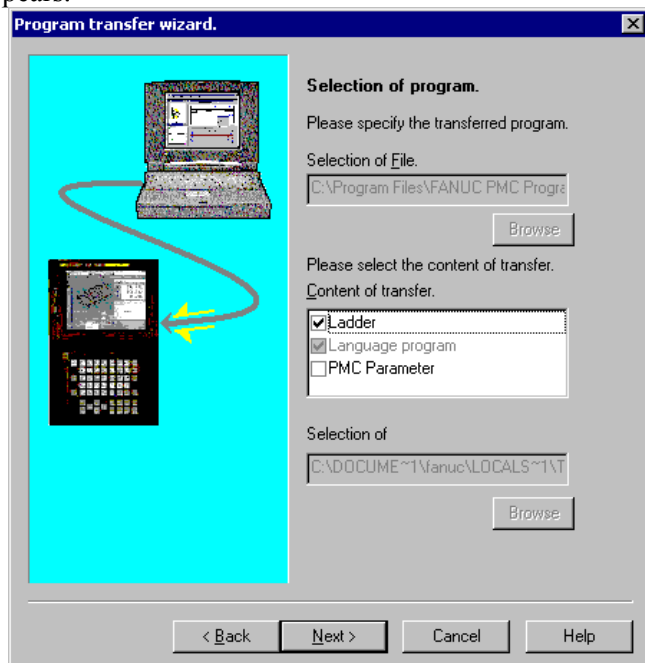

Fig. 7.4.1(f)

- 8 For the remainder of the procedure, see Section 7.5, "Storing Sequence Programs in the PMC (During Connection with the PMC)."

◆ <I/O by “I/O” key operation>

- 3 Select <I/O by “I/O” key operation>, and then click the <Next> button. The [Program transfer wizard Selection of loading/store] screen appears.

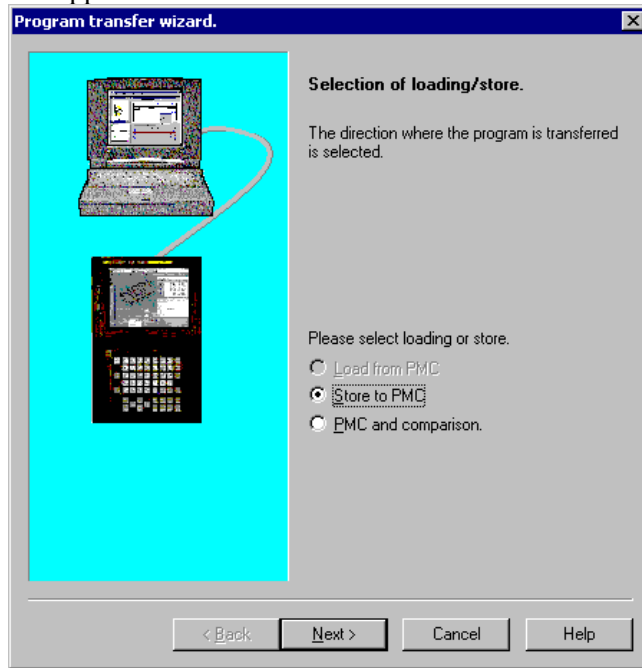

Fig. 7.4.1(g)

- 4 Click the <Next> button. The [Program transfer wizard Selection of program] screen appears.

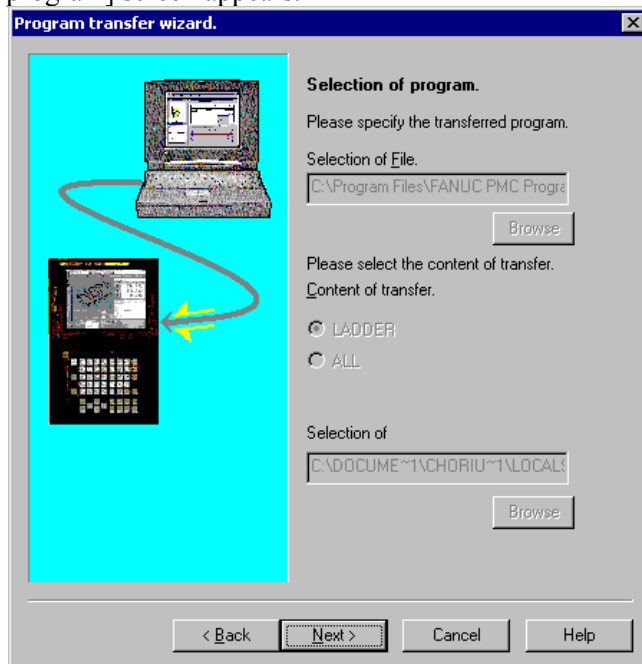

Fig. 7.4.1(h)

- 5 Select LADDER or ALL, then click the <Next> button.

- 6 The [Program transfer wizard Setting of communication] screen appears.
Set a communication protocol, and then click the <Next> button.

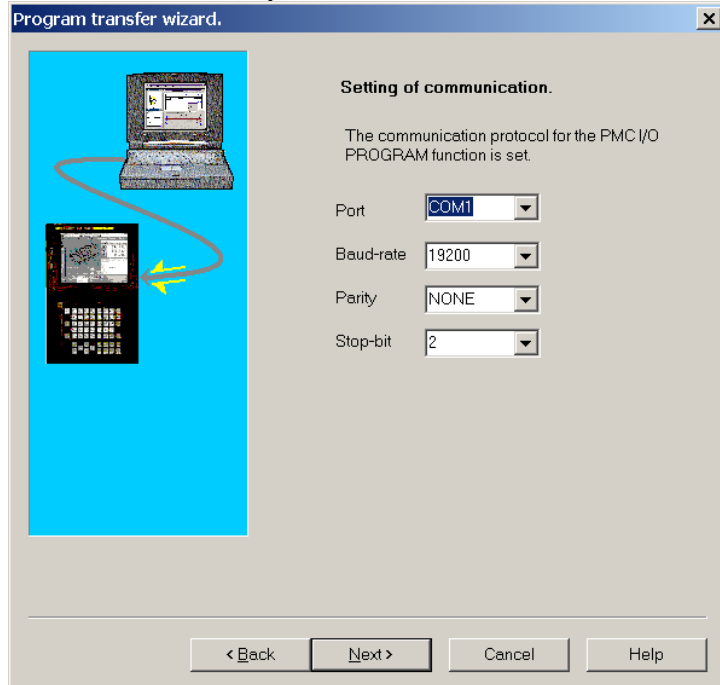

Fig. 7.4.1(i)

- 7 The [Program transfer wizard Confirmation of processing] screen appears.

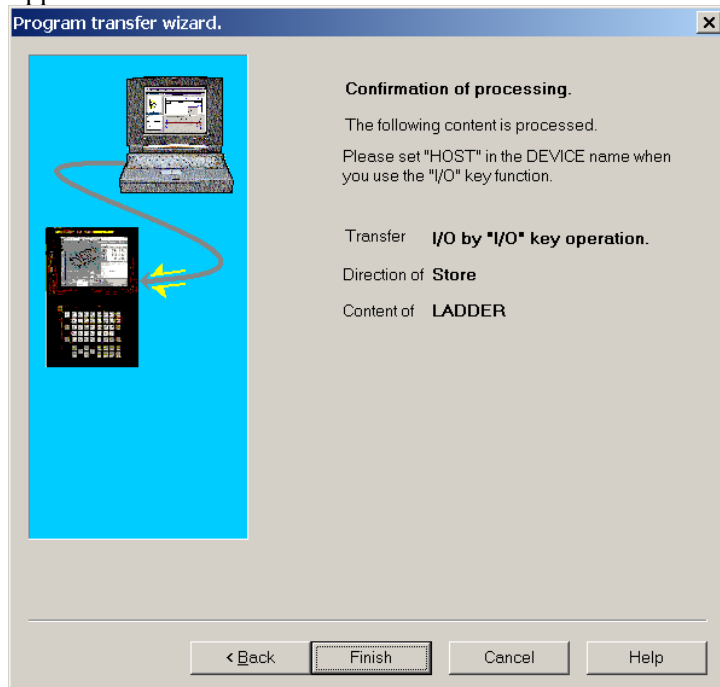

Fig. 7.4.1(j)

- 8 Click the <Finish> button. The [Execution of I/O transfer] screen appears.

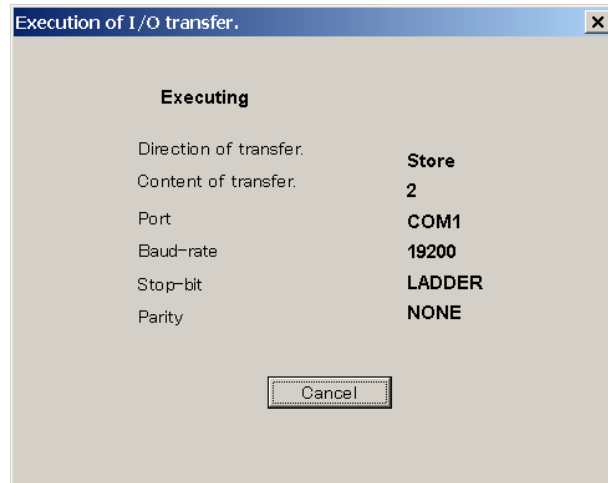

Fig. 7.4.1(k)

NOTE

Set CHANNEL, DEVICE, FUNCTION, and DATA KIND on the PMC I/O PROGRAM screen of the PMC in advance. Set HOST for DEVICE. For details of these settings, refer to the FANUC PMC Ladder Language Programming Manual (B-61863E).

Press soft key <EXEC> of the NC to place the NC in the standby status.

- 3 Once I/O transfer is complete, the following message appears.



Fig. 7.4.1(l)

7.5 STORING SEQUENCE PROGRAMS IN THE PMC (DURING CONNECTION WITH THE PMC)

7.5.1 Procedure

- 1 Select [File] - [Open Program] to open the program to be stored.
- 2 Select [Tool] - [Store to PMC].
The [Program transfer wizard Selection of program] screen appears.

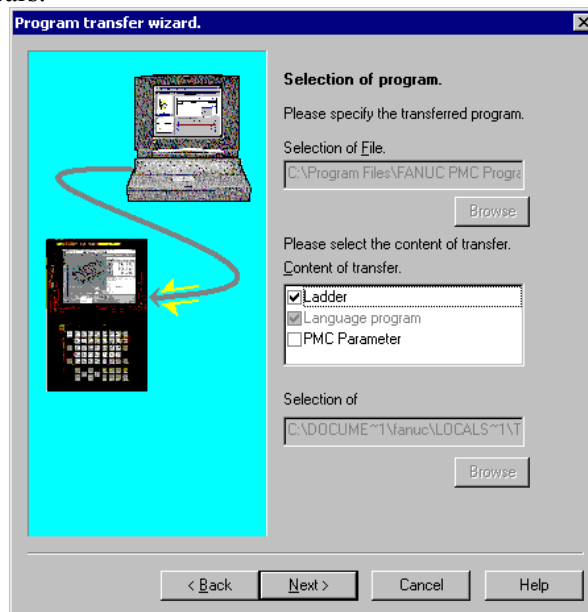

Fig. 7.5.1(a)

NOTE

When connection is not established, the [Communication] screen appears. Then establish connection.

- 2-1 Set data.

Content of transfer

As transfer information, a selection can be made from Ladders, Language program, and PMC Parameter.

When transferring PMC parameters, enter a transfer source file name in [Selection of]. The initial setting specifies that PMC_PRM.PRM in a user file folder is transferred.

For a user file folder, see Subsection 3.1.3, "Work Folders and Online Program Files."

An existing PMC parameter file can be stored in a user file folder by using the import function.

For the import function, see Section 3.14, "IMPORTING PROGRAMS."

- 2-2 Click the <Next> button. The [Program transfer wizard Confirmation of processing] screen appears.

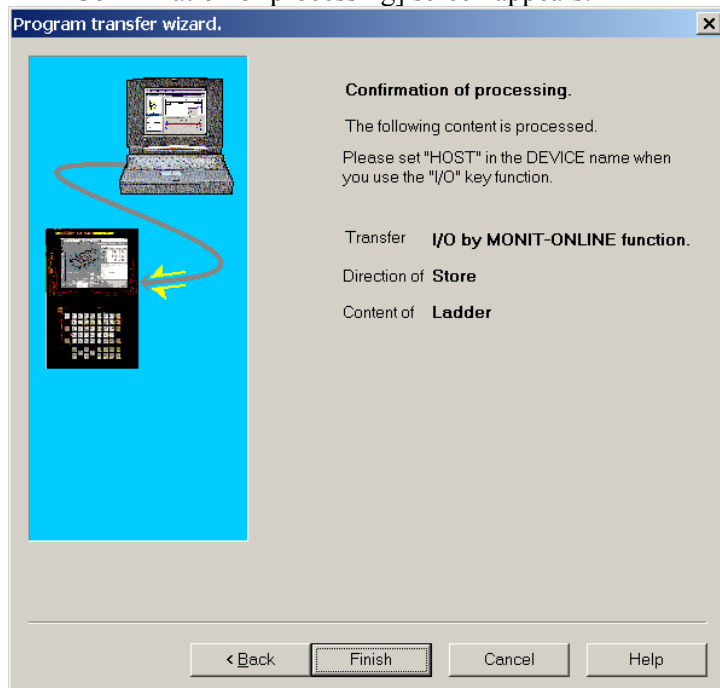

Fig. 7.5.1(b)

- 2-3 Check the setting items. Click the <Finish> button. Then, the [Transfer monitor] screen appears, and then the program is transferred.

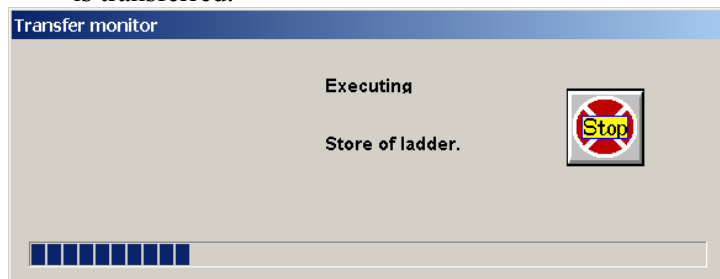

Fig. 7.5.1(c)

NOTE

- 1 During ladder editing in online mode, no program can be stored in the PMC. Store programs in the PMC while a ladder is being monitored.
- 2 After storing a program in the PMC, if the CNC is powered down without backing up the program, the editing results are lost. When you want to store a program in the CNC, execute [Backup].

7.6 WRITING SEQUENCE PROGRAMS INTO F-ROM

This section describes how to back up a program edited in online mode or a program stored in the PMC to F-ROM of the CNC.

7.6.1 Procedure

- 1 Select [Tool] - [Backup].
The [Backup of program] screen appears.

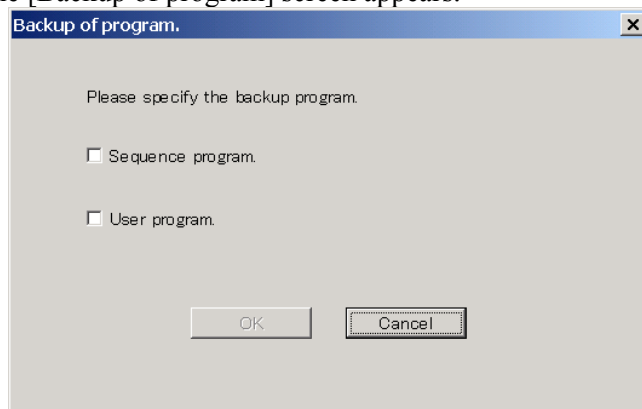

Fig. 7.6.1

- 2 Choose the check boxes of the programs you want to back up.
When the C language board is not mounted, you cannot choose "User C program."
- 3 To back up a program, click the <OK> button.
When backup is completed successfully, the [Backup of the program ended] message appears.
To cancel the backup of a program, click the <Cancel> button.

NOTE

- 1 Since the Power Mate-D (PMC-PA3) stores programs in S-RAM, the operation described above is not needed.
- 2 For other than the Power Mate-D (PMC-PA3), if the CNC is powered down without first backing up the programs, the edited programs and stored programs are lost. Back up the programs, before powering down the CNC.

7.7 COMPARING WITH PMC

You can compare programs with the I/O function, HOST operation.

7.7.1 Menu Bar

Select [Tool] - [Load from PMC...] or [Store to PMC...], and the transfer direction selection dialog box of the "Program transfer wizard" will appear.

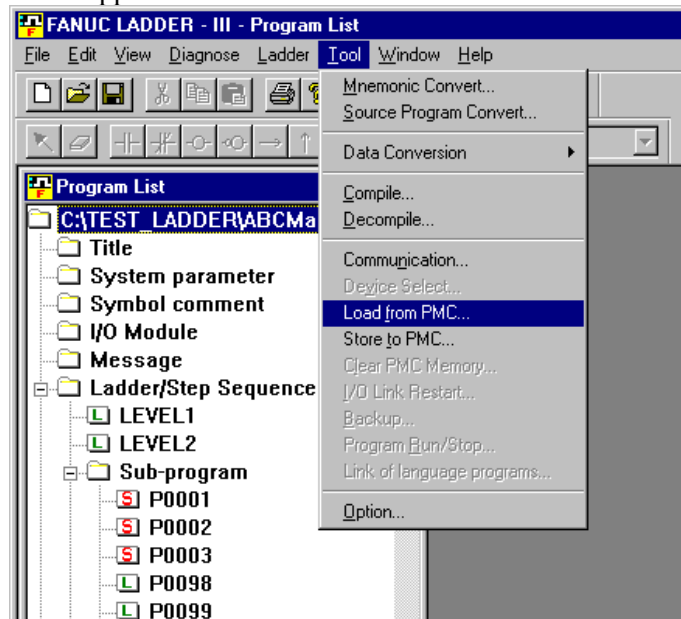

Fig. 7.7.1

NOTE

You can compare programs including language programs on each model of PMC-SC3, SC4, NB, and NB2.

7.7.2 Program Transfer Wizard

This wizard displays a group of dialog boxes for performing a series of setup operations necessary for program comparison operations. At the prompts on the dialog pages, set the necessary items.

7.7.2.1 Selecting a transfer method

To perform program comparison operations, select "I/O by "I/O" key operation" as a transfer method.



Fig. 7.7.2.1

7.7.2.2 Selecting a transfer direction

The transfer direction selection dialog box appears. To use the compare function, select "PMC and comparison" and click the <Next> button.

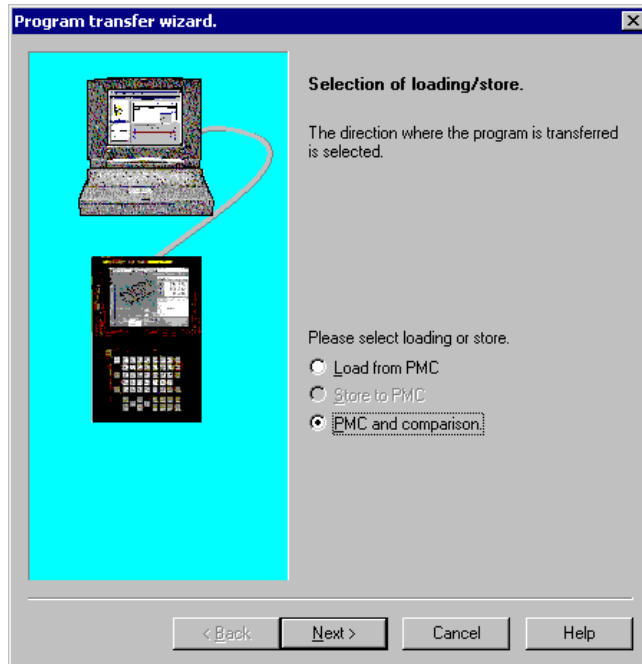

Fig. 7.7.2.2

On the subsequent pages of the wizard, follow the instructions indicated.

8

EXECUTING AND STOPPING SEQUENCE PROGRAMS

This chapter describes how to execute and stop sequence programs.



WARNING

Special care is needed when you execute or stop a program.

If a program is used inappropriately, the machine may operate in an unexpected manner.

It is recommended that you not use this machine while a person is near the machine.

How to check the execution or stop status

Check the execution or stop status on the status bar.

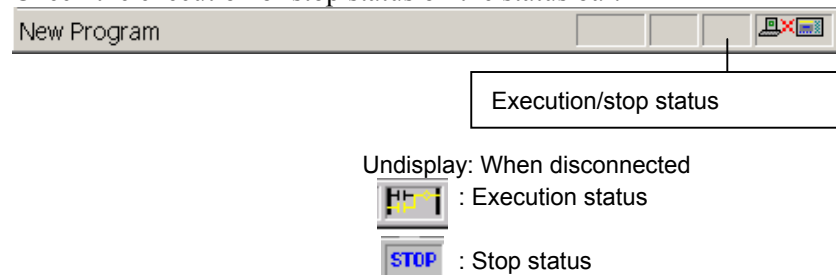

Fig. 8(a)

Preparation prior to accessing the PMC

Procedure

- 1 Connect a personal computer to the NC (PMC) with a cable. (For the specification of the required cable, see Appendix A.)
- 2 Check the communications status (connection or disconnection) with the PMC.

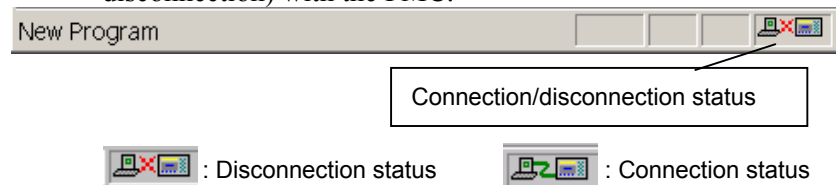

Fig. 8(b)

- 3 In the disconnection status, select [Tool]-[Communication]. The [Communication] screen appears.
- 4 Click the <Connect> button to establish a connection.

8.1 EXECUTING SEQUENCE PROGRAMS

This section describes the procedure for executing a sequence program.

Procedure

- 1 Select [Tool] - [Program Run/Stop].

For no language program:

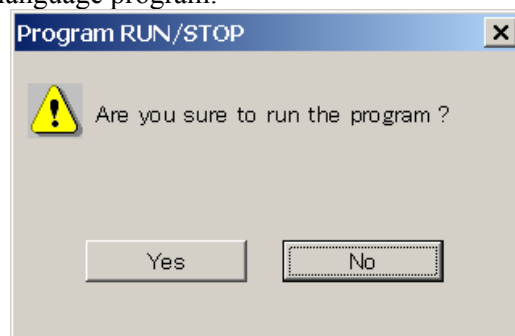

Fig. 8.1(a)

For a language program:

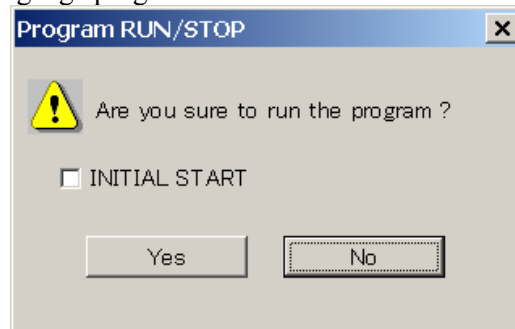

Fig. 8.1(b)

Yes

A sequence program is to be executed.

No

The dialog box is closed without executing a sequence program.

INITIAL START

Selected: A language program is to be executed from the beginning.

Unselected: A language program is to be executed from the last-terminated position.

8.2 STOPPING SEQUENCE PROGRAMS

This section describes the procedure for stopping sequence programs.

Procedure

- 1 Select [Tool] - [Program Run/Stop].

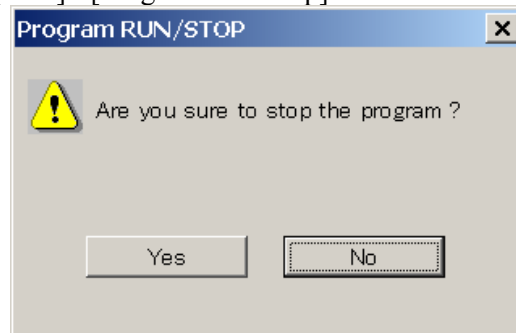

Fig. 8.2

Yes

A sequence program is to be stopped.

No

The dialog box is to be closed without stopping the sequence program.

NOTE

When the PMC-MDI screen is displayed by a language program on the NC, no program can be stopped. To stop the program, select another screen on the NC.

9

DIAGNOSIS

This chapter describes the online diagnosis function for ladder monitoring, PMC status, PMC parameters, signal trace, and signal waveform display.

9.1 LADDER MONITORING



CAUTION

- 1 The online monitor function for step sequence programs is not supported.
- 2 If the system being used is not supported by the connected PMC, the online functions sometimes cannot be used. Use a system with a supported edition.

9.1.1 Procedure

- 1 Select [File] - [Open Program] to open the program you want to monitor.
- 2 When the system is in offline mode, select [Ladder] - [Online/Offline] to set online mode.
When the <On-Line/Off-Line Change> button is in the up state, the system is in offline mode. When the button is in the down state, the system is in online mode.



<On-Line/Off-Line Change button>

- 3 Select [Ladder] - [Monitor/Editor] to switch between the [Monitor] screen and [Edit] screen.
On the [Monitor] screen, the <Ladder Monitor> button is in the down state.
On the [Edit] screen, the <Online Editor> button is in the down state.

9.1.2 [Monitor] Screen

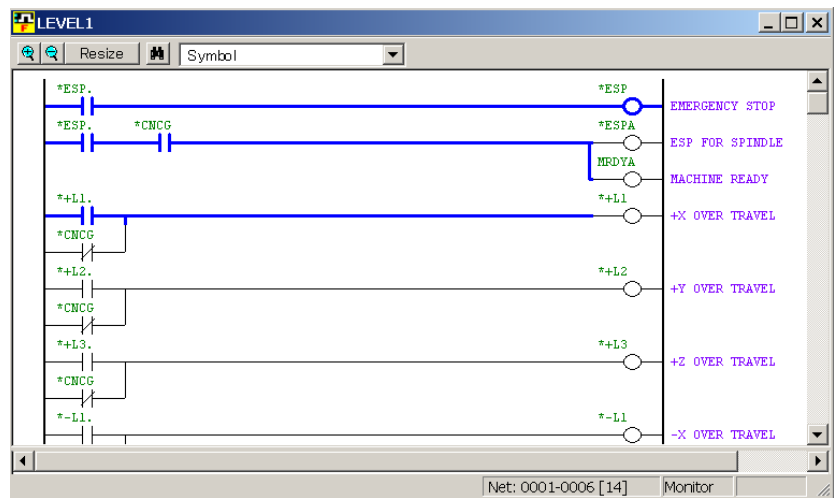

Fig. 9.1.2

The screen is scrolled by using the direction keys, page keys, and scroll bars.

The signal ON and OFF states are expressed by the line thickness.

ON :
 OFF :

9.1.3 [Edit] Screen

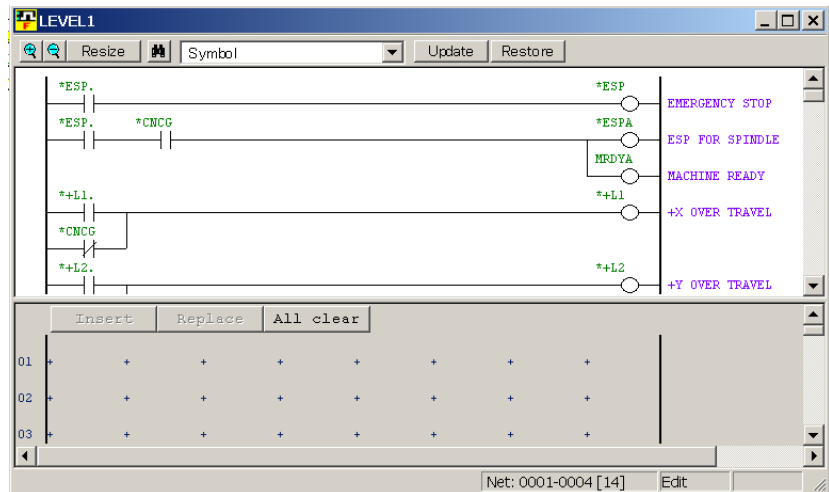

Fig. 9.1.3(a)

The <Update> button on the toolbar writes the edited ladder program to the PMC.

The <Restore> button restores the ladder program to its original state that existed before editing.



Fig. 9.1.3(b)

CAUTION

- 1 Executing the update function alters the ladder program on the PMC.
Before executing the update function, carefully check whether it is safe to alter the ladder program. Except for the Power Mate-D (PMC-PA3), powering off the CNC without backing up the program clears the program changes.
Before powering off the CNC, click the <Update> button on the toolbar and then back up the program.
- 2 To reflect the results of editing a ladder program in online mode in the source program in the sequence program (LAD file), switch to offline mode to automatically execute decompilation. or execute decompilation manually.

For other edit operations, see Section 3.5, "EDITING LADDER DIAGRAMS."

9.1.3.1 Multiple used check of the functional instruction parameter number

When the <Update> button on the online editing screen is pushed, multiple use of the following functional instruction parameter number is checked.

Supported instructions

Multiple use of the following functional instruction parameter number is checked.

SUB3(TMR)
 SUB24(TMRB)
 SUB77(TMRBF)
 SUB5(CTR)
 SUB56(CTRB)
 SUB57(DIFU)
 SUB58(DIFD)

Operation

1. Push the <Update> button on online editing screen.
2. The following screen will be displayed if multiple use of the parameter number of functional instruction was found.

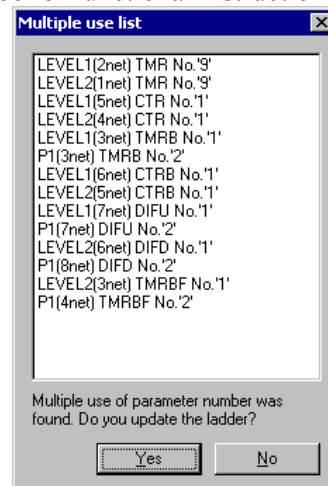

Fig. 9.1.3.1(a)

- Push the <Yes> button if you want to update the ladder of multiple use of parameter number.
- Push the <No> button if you want to modify the ladder of multiple use of parameter number.

NOTE

- 1 Multiple use of the parameter number of TMRB and TMRBF instruction is checked.
- 2 Multiple use of the parameter number of DIFU and DIFD instruction is checked.

9.1.4 Signal Trigger Stop Function

9.1.4.1 Procedure

- 1 Select [File] - [Open Program] to open the program you want to monitor.
- 2 When the system is in offline mode, select [Ladder] - [Online/Offline] to set online mode.
When the <On-Line/Off-Line Change> button is in the up state, the system is in offline mode. When the button is in the down state, the system is in online mode.



<On-Line/Off-Line Change button>

- 3 Choose [Ladder Mode - Signal Trigger] from the [Ladder] menu. The <Signal Trigger> button is held down, and the [Signal Trigger] screen appears. At the bottom of the screen, Trigger Mode, Check Point, Address, Count, and Time are displayed. (See Subsection 9.1.4.4, "[Trigger Parameter] screen.")

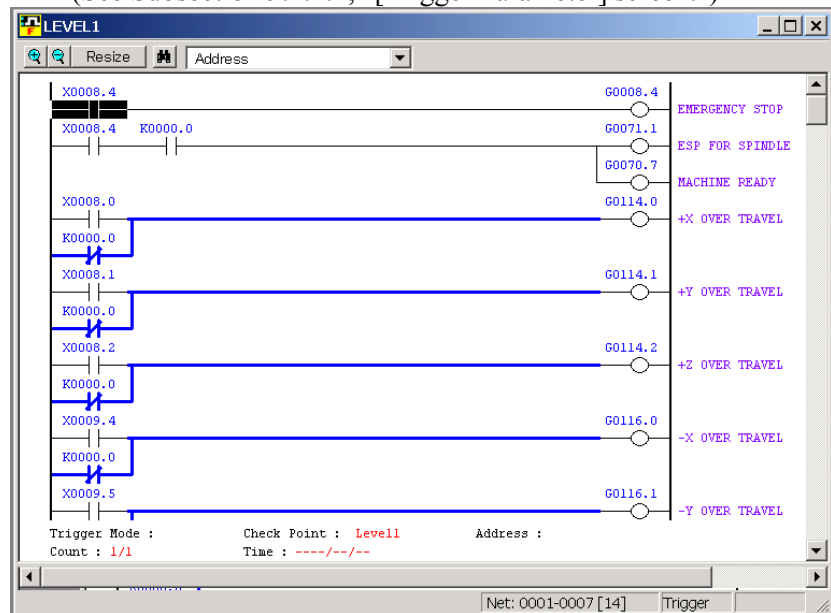

Fig. 9.1.4.1

9.1.4.2 Executing the signal trigger stop function

- 1 Choose [Signal Trigger - Start] from the [Ladder] menu.
The [Signal Trigger Stop Function] execution screen appears.
During execution, the status bar of the main frame displays an icon indicating that the signal trigger stop function is being executed.

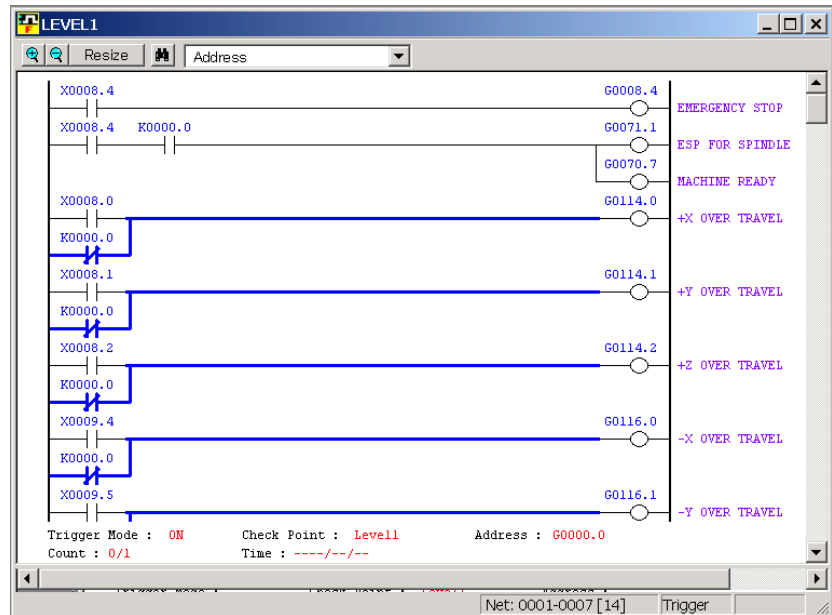

Fig. 9.1.4.2



<Icon for indicating that the signal trigger stop function is being executed>

9.1.4.3 Terminating the signal trigger stop function

- 1 When the signal trigger stop condition is satisfied, the [Signal Trigger] screen appears, and sample data is collected.

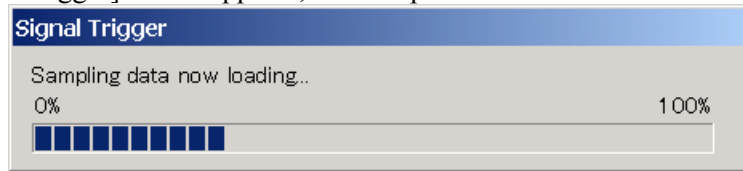

Fig. 9.1.4.3(a)

- 2 The [Signal Trigger Stop Function] termination screen appears. Trigger stop time on the NC side is displayed.

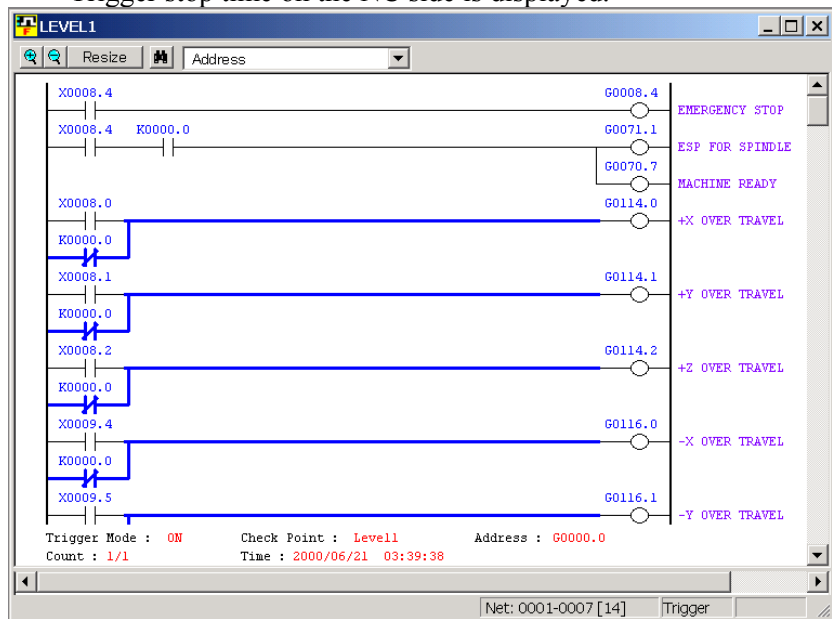

Fig. 9.1.4.3(b)

9.1.4.4 [Trigger Parameter] screen

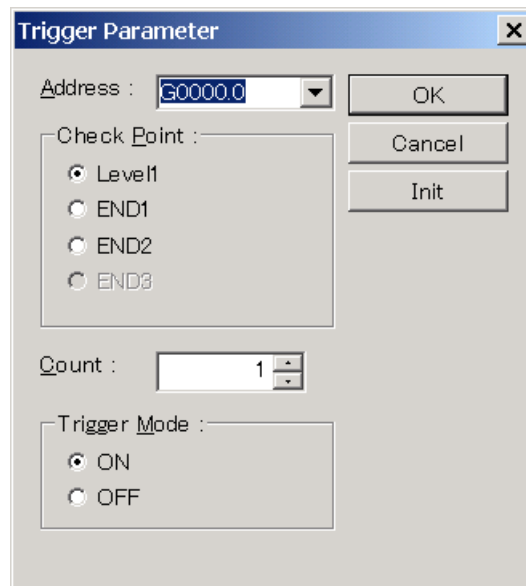

Fig. 9.1.4.4

Address

Set a trigger address. (Symbol input is possible.)

Check Point

Select a trigger check point.

Make a selection from Level1 (start of LEVEL1), END1 (after END1 instruction execution), END2 (after END2 instruction execution), and END3 (after END3 instruction execution, selectable with a model that can use LEVEL3).

Count

Set a trigger count (1 to 65535).

Trigger Mode

ON: Stops triggering on the rising edge of a specified address signal.

OFF: Stops triggering on the falling edge of a specified address signal.

<Init> button

This button initializes the parameters as follows:

Address: Blank

Check Point: LEVEL1

Count: 1

Trigger Mode: Disabled

9.1.4.5 Context menu

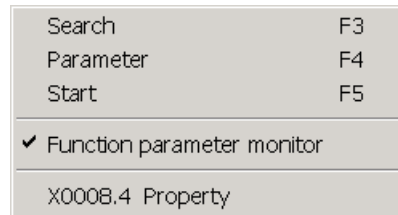

Fig. 9.1.4.5

9.1.4.6 Shortcut key list

Table 9.1.4.6

Shortcut key	Corresponding function
[F3]	Search
[F4]	Parameter setting
[F5]	Execution

9.1.5 Mnemonic Monitor

A language selection of monitor screen

This section describes the procedure for selecting the language of monitor screen.

To display the PMC program made by mnemonic files with a mnemonic language monitor screen, please select the monitor language by the following procedure.

Procedure

1. Select [Tool] – [Option...]. Then, the [Option - General] dialog appears.

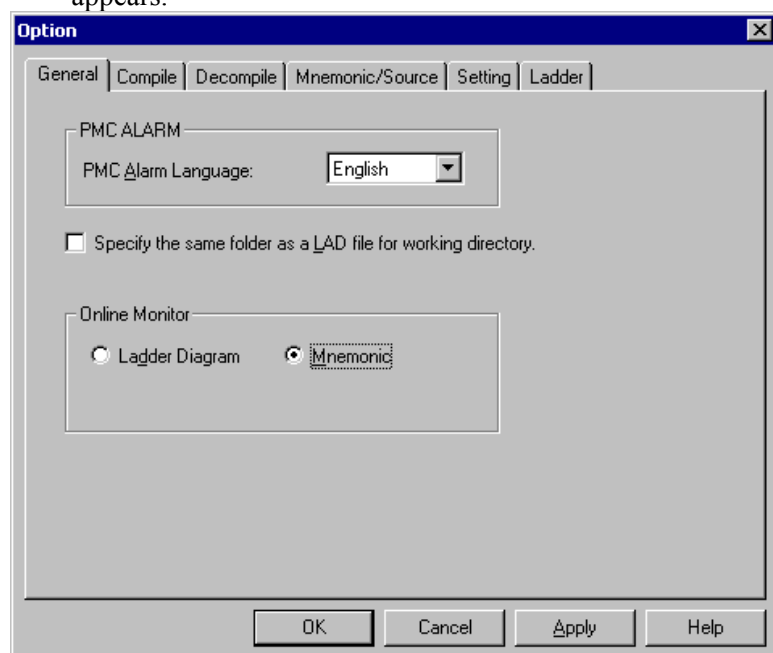

Fig. 9.1.5 (a)

2. To select the language of monitor screen, click [Ladder Diagram] or [Mnemonic].
3. When pressed <OK> button or <Apply> button, the language of monitor screen is settled.

NOTE

The following screens are always displayed with ladder language

- Collective display
- Search results list display

Mnemonic monitor screen

This section describes the procedure for displaying a mnemonic monitor screen.

Procedure

1. Select [View] - [Program List]. The [Program List] screen appears. (Usually, this screen appears automatically when a LAD file is created or opened.)
2. Check the current programmer mode (offline or online). If the programmer mode is offline, select [Ladder] - [Programmer Mode] - [Online] or click <Online/Offline change> button to change the programmer mode to online.
3. Check the current ladder mode (monitor or editor). If the ladder mode is editor, select [Ladder] - [Ladder Mode] - [Monitor] or click <Ladder Monitor> button to change the ladder mode to monitor.
4. On the [Program List] screen, double-click the ladder program you want to monitor. Alternatively, select the ladder program and press the [Enter] or [F10] key.

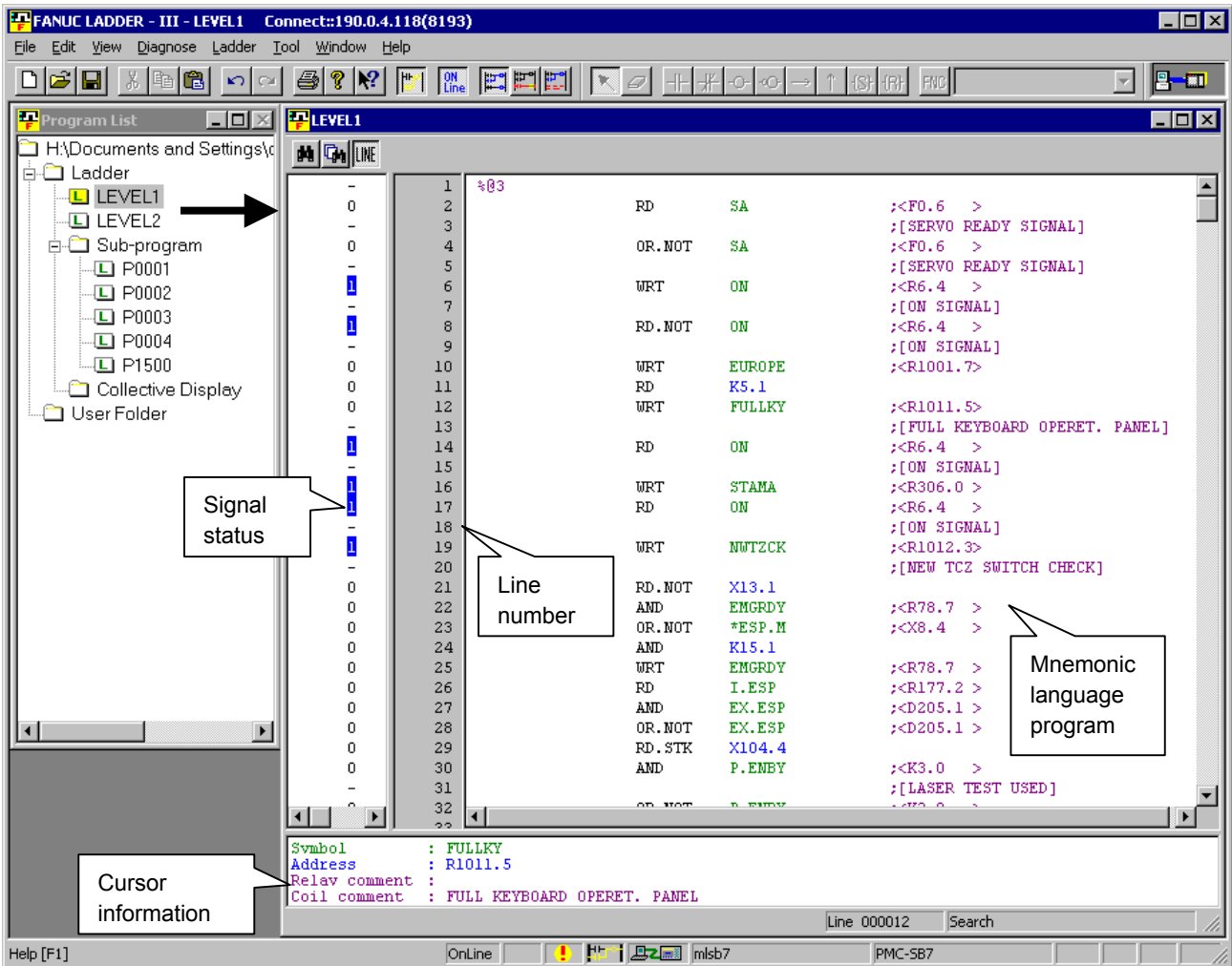

Fig. 9.1.5 (b) Mnemonic monitor screen

Mnemonic data in a mnemonic monitor screen

When the mnemonic data used at a mnemonic file conversion is corresponding to the PMC side, it is displayed in a mnemonic monitor screen.

When there is no mnemonic data for monitoring or the mnemonic data is not corresponding to the PMC side, the following dialog-box is displayed.

Please select a mnemonic format (P-G Compatible, Label/Subprogram, Full option). And then, a mnemonic monitor screen is displayed with the selected format.

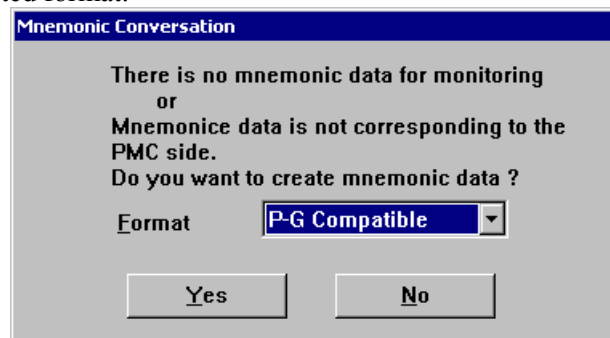

Fig. 9.1.5 (c)

Toolbar



<1> <2> <3>

<1> Display a [Search setting] dialog-box (Ctrl+F)

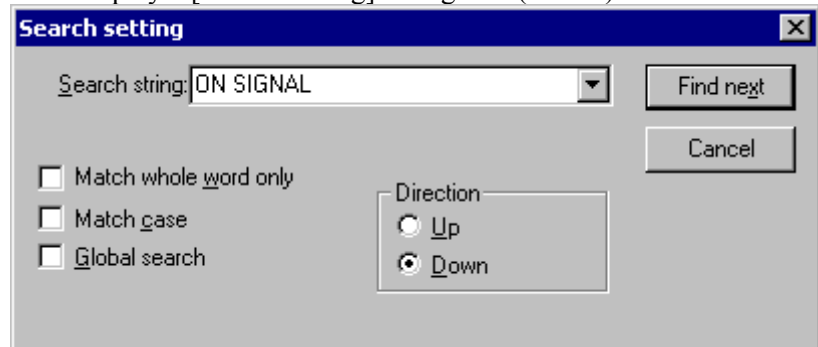

Fig. 9.1.5 (d)

<2> Switch search area (Global/Local) (Ctrl+F3)

<3> Display a line number (off/on)

Shortcut keys

Table 9.1.5

Shortcut key	Corresponding function
[F3]	Search (downward)
[Shift]+[F3]	Search (upward)
[Ctrl]+[F3]	Switch search area (Global/Local)
[Ctrl]+[F]	Display a [Search setting] dialog-box

9.2 SIGNAL STATUS

The PMC signal status can be displayed and changed in real-time.



WARNING

Special care must be taken when the signal status or PMC parameters are changed. If the change function is not used appropriately, the machine operation may be unpredictable.

When there are people near the machine, this function should not be used.



CAUTION

- 1 The statuses of some signals cannot be changed. The status of such a signal is not changed when a sequence program, the CNC, the MMC, or an external I/O unit such as the I/O Link is repeatedly writing data into the address of the signal. (The CNC repeatedly writes data to address F, the MMC repeatedly writes data to address M, and the external I/O unit repeatedly writes data to address X.)
- 2 When a bit signal of the D8192-D9999 addresses is changed, other bit signals of the same byte address are overwritten at the same time. Therefore, it can happen that the signal state might not change as specified if the signals of the same D address is changed by the PMC program and the CNC at the same time.

9.2.1 Procedure

- 1 Select [Diagnose] - [Signal Status]. The [Signal Status] screen appears.

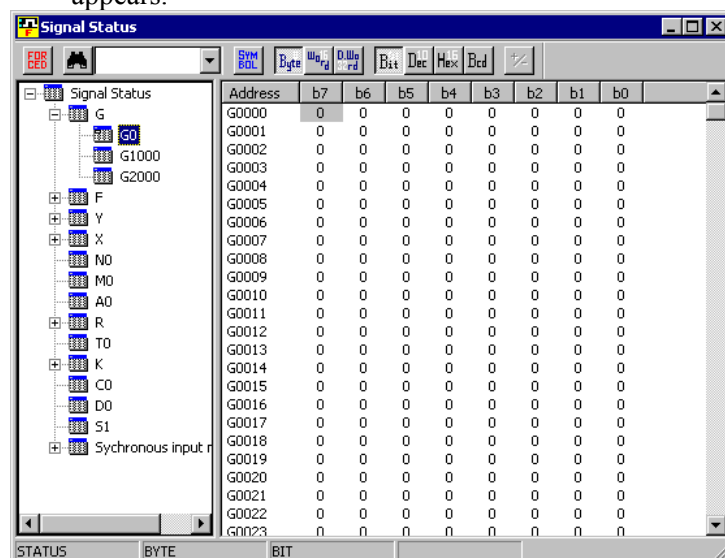

Fig. 9.2.1

9.2.2 Toolbar

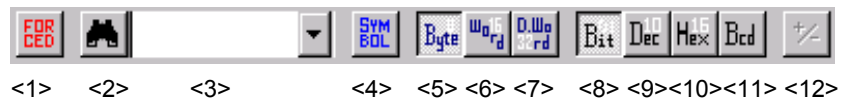

Fig. 9.2.2

- <1> Switches between the status screen and forced I/O screen.
- <2> Search button
- <3> Combo box for inputting the character string for which a search is to be made
- <4> Symbol indication (off ↔ on)
- <5> Display format: Byte
- <6> Display format: Word
- <7> Display format: Double word
- <8> Display type: Binary
- <9> Display type: Decimal
- <10> Display type: Hexadecimal
- <11> Display type: BCD
- <12> Sign indication (off ↔ on)
(Valid only when decimal notation is set as the display type.)

9.2.3 Status Bar



Fig. 9.2.3

- <1> Selection mode
[Status] or [Force] is indicated.
- <2> Display format
[Byte], [Word], or [Dword] is indicated.
- <3> Display type
[Bit], [Decimal], [Hex], or [Bcd] is indicated.

9.2.4 Context Menu

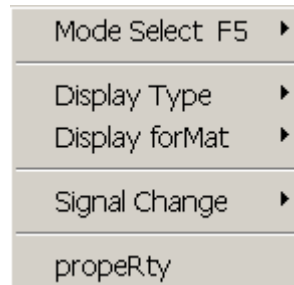

Fig. 9.2.4

9.2.5 Shortcut Keys

Table 9.2.5

Shortcut key	Corresponding function
[F2]	Turns on a signal. (Forced I/O)
[F3]	Turns off a signal. (Forced I/O)
[F4]	Symbol indication (off↔on)
[F5]	Switches between the status screen and forced I/O screen.
[Ctrl]+[F]	Search

9.3 PMC PARAMETERS

PMC parameters (timers, counters, keep relays, and data table) are displayed.

⚠ WARNING
 Special care must be taken when the signal status or PMC parameters are changed. If the change function is not used appropriately, the machine operation may be unpredictable.
 When there are people near the machine, this function should not be used.

⚠ CAUTION
 When PMC parameters should not be changed, the parameters may be protected.
 Refer to the relevant programming manual for the PMC being used.

9.3.1 Procedure

- 1 Select [Diagnose] - [PMC Parameter].
- 2 Display the pull-down menu, and then select [Timer], [Counter], [Keep Relay], [Data Table], or [Set Up].

9.3.2 Timer

The contents of the timer address locations (T) used with the TMR instruction can be displayed and modified.

When the timer accuracy is fixation by the timer number

No.	Address	Data	No.	Address	Data	No.	Address	Data	No.	Address
1	T00	96	17	T32	8	33	T64	8	49	T96
2	T02	960	18	T34	0	34	T66	0	50	T98
3	T04	0	19	T36	8	35	T68	8	51	T100
4	T06	0	20	T38	0	36	T70	0	52	T102
5	T08	0	21	T40	8	37	T72	8	53	T104
6	T10	0	22	T42	0	38	T74	0	54	T106
7	T12	0	23	T44	8	39	T76	8	55	T108
8	T14	0	24	T46	0	40	T78	0	56	T110
9	T16	16	25	T48	8	41	T80	8	57	T112
10	T18	0	26	T50	0	42	T82	0	58	T114
11	T20	16	27	T52	8	43	T84	8	59	T116
12	T22	0	28	T54	0	44	T86	0	60	T118
13	T24	8	29	T56	8	45	T88	8	61	T120
14	T26	0	30	T58	0	46	T90	0	62	T122
15	T28	8	31	T60	8	47	T92	8	63	T124
16	T30	0	32	T62	0	48	T94	0	64	T126

MINIMUM TIME : 48 MAXIMUM TIME : 1572816

Fig. 9.3.2 (a)

When you can set the timer accuracy of each timer number

No.	Address	Data	Accuracy	No.	Address	Data	Accuracy
1	T00	192MS	48MSEC	9	T16	24MS	8MSEC
2	T02	200MS	1MSEC	10	T18	48MS	8MSEC
3	T04	500MS	10MSEC	11	T20	96MS	8MSEC
4	T06	900MS	100MSEC	12	T22	144MS	8MSEC
5	T08	00H_01M_30S	1SEC	13	T24	248MS	8MSEC
6	T10	00H_40M_00S	1MIN	14	T26	0MS	8MSEC
7	T12	48MS	48MSEC	15	T28	0MS	8MSEC
8	T14	96MS	48MSEC	16	T30	0MS	8MSEC

Fig. 9.3.2 (b)

9.3.2.1 Toolbar



Fig. 9.3.2.1

- <1> Symbol indication (off↔on)
- <2> Search
- <3> Combo box for inputting the character string for which a search is to be made
- <4> Units of the displayed timer value (msec, sec, min)
This item appears only when the timer accuracy is set for each timer number.

9.3.2.2 Status bar



Fig. 9.3.2.2

- <1> Minimum setting time for the timer selected with the cursor
- <2> Maximum setting time for the timer selected with the cursor

9.3.2.3 Context menu

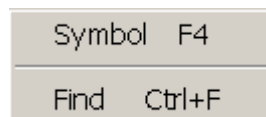

Fig. 9.3.2.3

9.3.2.4 Shortcut keys

Table 9.3.2.4

Shortcut key	Corresponding function
[F4]	Symbol indication (off↔on)
[Ctrl]+[F]	Search

9.3.3 Counter

The contents of the counter address locations (C) used with the CTR instruction can be displayed and modified.

No.	Address	PRESET	CURRENT	No.	Address	PRESET	CURRENT	No.	Address	PRESET	CU
1	C000	7?	0	18	C068	0	0	35	C136	0	
2	C004	?	0	19	C072	0	0	36	C140	0	
3	C008	13	0	20	C076	0	0	37	C144	0	
4	C012	36	0	21	C080	0	0	38	C148	0	
5	C016	20	0	22	C084	0	0	39	C152	0	
6	C020	0	0	23	C088	0	0	40	C156	0	
7	C024	0	0	24	C092	0	0	41	C160	0	
8	C028	0	0	25	C096	0	0	42	C164	0	
9	C032	0	0	26	C100	0	0	43	C168	0	
10	C036	0	0	27	C104	0	0	44	C172	0	
11	C040	0	0	28	C108	0	0	45	C176	0	
12	C044	0	0	29	C112	0	0	46	C180	0	
13	C048	0	0	30	C116	0	0	47	C184	0	
14	C052	0	0	31	C120	0	0	48	C188	0	
15	C056	0	0	32	C124	0	0	49	C192	0	
16	C060	0	0	33	C128	0	0	50	C196	0	
17	C064	0	0	34	C132	0	0	51	C200	0	

Fig. 9.3.3

NOTE

- 1 The contents can be displayed and modified in binary or BCD according to the setting of the counter data type system parameter.
- 2 Data which cannot be displayed in BCD is indicated with a question mark (?).

9.3.3.1 Toolbar



Fig. 9.3.3.1

- <1> Symbol indication (off ↔ on)
- <2> Search
- <3> Combo box for inputting the character string to be searched for

9.3.3.2 Context menu

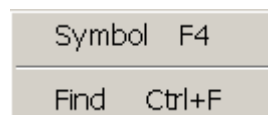

Fig. 9.3.3.2

9.3.3.3 Shortcut keys

Table 9.3.3.3

Shortcut key	Corresponding function
[F4]	Symbol indication (off↔on)
[Ctrl]+[F]	Search

9.3.4 Keep Relay

The contents of the keep relays (K) can be displayed and modified.

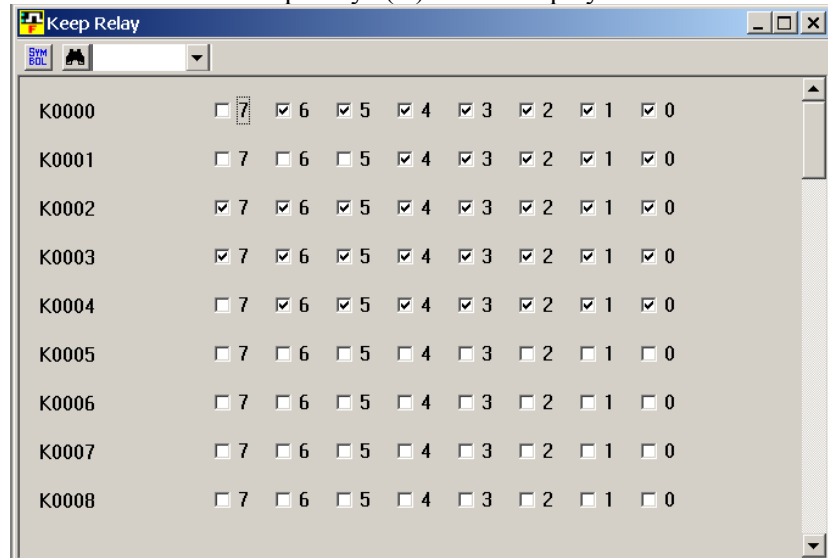

Fig. 9.3.4

9.3.4.1 Toolbar

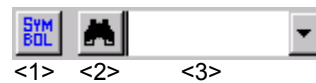

Fig. 9.3.4.1

- <1> Symbol indication (off ↔ on)
- <2> Search
- <3> Combo box for inputting the character string for which a search is to be made

9.3.4.2 Context menu

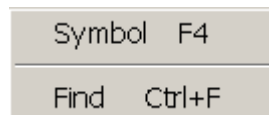

Fig. 9.3.4.2

9.3.4.3 Shortcut keys

Table 9.3.4.3

Shortcut key	Corresponding function
[F4]	Symbol indication (off↔on)
[Ctrl]+[F]	Search

9.3.4.4 Data for PMC control software

Because some keep relays are used by the PMC control software, sequence programs cannot use the data in these keep relays.

This subsection describes only the signals relating to online function operations. For detailed information and other signals, refer to the "PMC Ladder Language Programming Manual" (B-61863E).

The bits marked * are used by the PMC control software and are not related to the online function operations.

K17 or K900

#7	#6	#5	#4	#3	#2	#1	#0
DTBLDSP	*	*	MEMINP	*	*	PRGRAM	LADMASK

Bit	Value	Meaning
#7	1	Does not display the PMC parameter data table control screen.
#4	0	Does not allow you to change the signal status.
#1	0	Does not allow you to use the online edit function and I/O function.
#0	0	Does not display the ladder monitor screen.

K19 or K902

#7	#6	#5	#4	#3	#2	#1	#0
*	*	*	*	*	*	*	FROM-WRT

Bit	Value	Meaning
#0	1	Displays a dialog box for writing to F-ROM at the end of online editing.

9.3.5 Data Table

In Data Table, there are two screens of the data table control data and the data table.

(1) Data table control data screen

The data table control data to manage the data table is displayed.

When “DATA TABLE” in tree view is selected, either of following two screens is displayed.

- PMC model which supports minus sign display and bit display

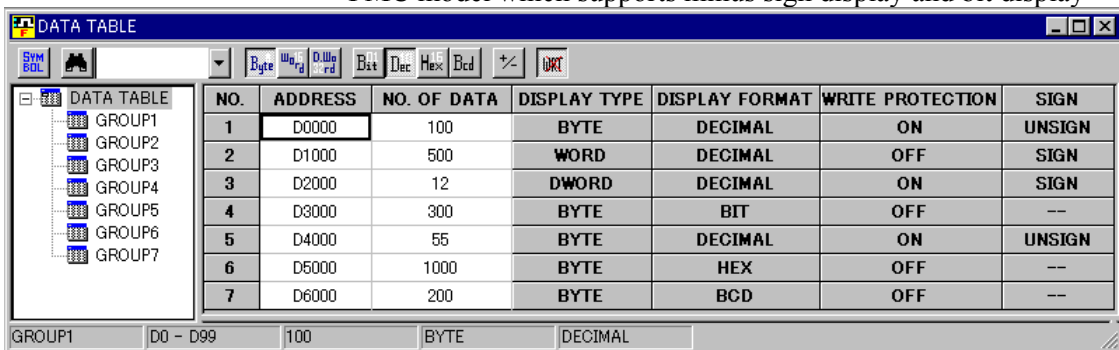

Fig. 9.3.5 (a)

- PMC model which does not support minus sign display and bit display

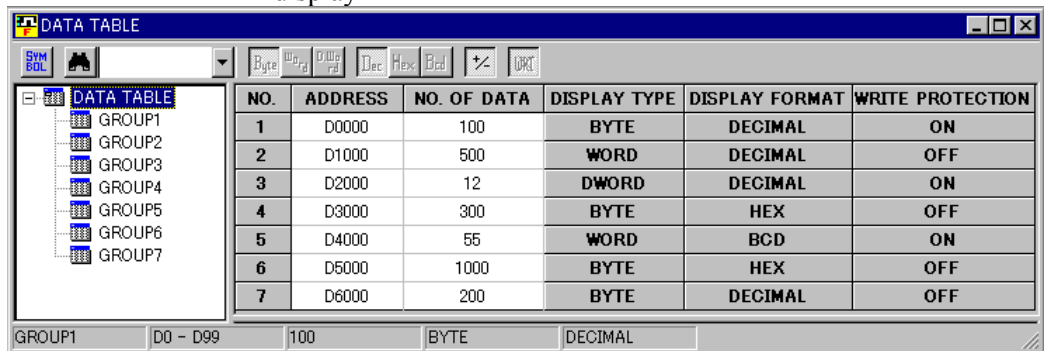

Fig. 9.3.5 (b)

(2) Data table screen

The contents of the data table (D) can be displayed and modified. By selecting the group number which you want to display, the content of the data table is displayed.

- Bit display

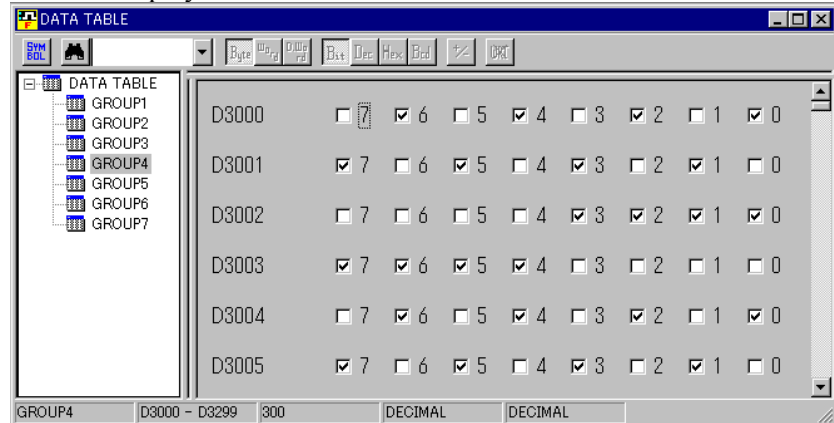

Fig. 9.3.5 (c)

- Excluding the bit display (byte/word/double word)

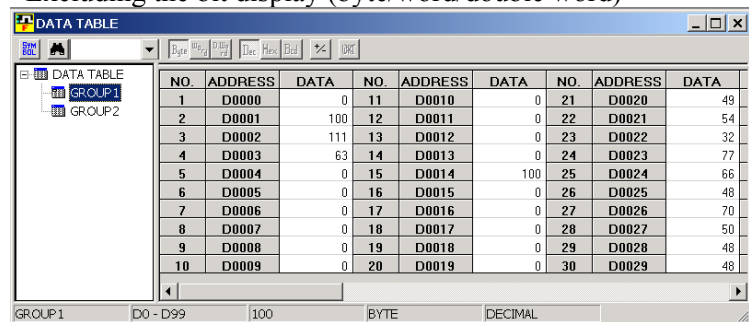

Fig. 9.3.5 (d)

9.3.5.1 Toolbar



Fig. 9.3.5.1

- <1> Symbol indication (off ↔ on)
- <2> Search
- <3> Combo box for inputting the character string for which a search is to be made
- <4> Display format: Byte
- <5> Display format: Word
- <6> Display format: Double word
- <7> Display type: Bit
- <8> Display type: Decimal
- <9> Display type: Hexadecimal
- <10> Display type: BCD
- <11> Sign indication (off ↔ on)
- <12> Write protection

9.3.5.2 Status bar

GROUP1	D0 - D99	100	BYTE	DECIMAL
<1>	<2>	<3>	<4>	<5>

Fig. 9.3.5.2

- <1> Group name
- <2> Range of data area
- <3> Number of data items
- <4> Display format
[Byte], [Word], or [Dword] is indicated.
- <5> Display type
[Bit], [Decimal], [Hex], or [BCD] is indicated.

9.3.5.3 Shortcut keys

Table 9.3.5.3

Shortcut keys	Corresponding function
[F4]	Symbol indication (off↔on)
[Ctrl]+[F]	Search

9.3.5.4 Input data range

Table 9.3.5.4

	Byte	Word	Double word
Decimal	-128 to 127	-32,768 to 32,767	-2,147,483,648 to 2,147,483,647
Hexadecimal	0 to FF	0 to FFFF	0 to FFFFFFFF
BCD	0 to 99	0 to 9,999	0 to 99,999,999

9.3.5.5 Context menu

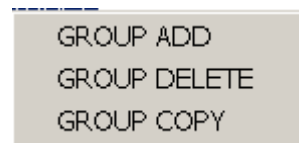

Fig. 9.3.5.5

9.3.6 Setting PMC Setting Parameters

PMC setting parameters can be made valid or invalid.

9.3.6.1 Programmer protect function

**CAUTION**

The subsequent subsections contain information important to the developer of the application systems to be controlled by the PMC. If the design of an application system is inappropriate, security problems are more likely to occur. Use great caution when operating the functions described in the subsequent subsections and designing application systems using these functions.

The PMC provides a variety of editing, diagnosis, and debugging functions to support sequence program development and debugging. These functions, which may disable the safety mechanism provided by sequence programs, are assumed to be used only by those operators who are familiar with the operation of sequence programs and that of the PMC. These functions must be protected with appropriate settings or sequence programs from being inadvertently operated by regular operators after the machine has been shipped to the field. If any of these functions are to be used for the maintenance and adjustment of the machine in the field, the machine developer is required to make sure that the machine is placed in a safe state before the means for enabling these functions are incorporated and that operators observe the techniques for ensuring safety.

The parameters described in the subsequent subsections are designed so that the system designer can set the conditions necessary for preventing erroneous operations such as those that "stop the Ladder program inadvertently" and that "change the settings of sequence programs and various functions" and for operating PMC programmer functions safely and so that such conditions are controllable with sequence programs.

The programmer protect function can be set with the appropriate setting parameter or keep relay data for PMC management software (PMC-SB7: K900 to 919, PMC-SA1: K17 to 19).

9.3.6.2 Procedure

1. Check the setting parameters you want to make valid.

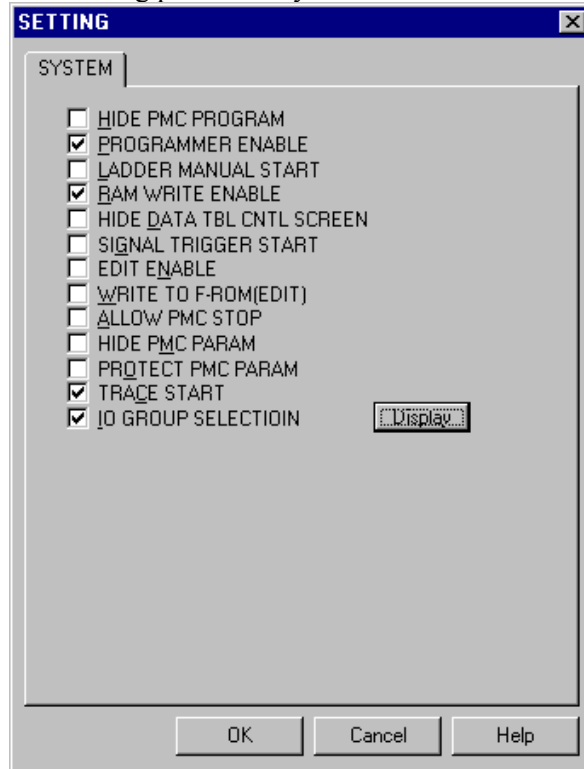

Fig. 9.3.6.2

2. To save the changes, click the <OK> buttons.
To cancel the changes, click the <Cancel> button.

9.3.6.3 Setting items

- HIDE PMC PROGRAM (PMC-SB7: K900.0, PMC-SA1: K17.0)
Not checked : Displays sequence programs.
Checked : Hides sequence programs.
- PROGRAMMER ENABLE (PMC-SB7: K900.1, PMC-SA1: K17.1)
Not checked : Disables built-in programmer functions.
Checked : Enables built-in programmer functions.
- LADDER MANUAL START (PMC-SB7: K900.2, PMC-SA1: K17.2)
Not checked : After the power is turned on, sequence programs will be automatically executed.
Checked : Sequence programs will be executed with the sequence program execution soft key.
- RAM WRITE ENABLE (PMC-SB7: K900.4, PMC-SA1: K17.4)
Not checked : Disables the forcing and overwrite functions.
Checked : Enables the forcing and overwrite functions.
- SIGNAL TRACE START (PMC-SB6: K900.5)
Not checked : The signal trace function starts tracing with the trace execution button.
Checked : The signal trace function automatically starts tracing after the power is turned on.
- SIGNAL ANALYSIS START (PMC-SB6: K900.6)
Not checked : The signal waveform display function starts sampling with the execution button.
Checked : The signal waveform display function automatically starts sampling after the power is turned on.
- HIDE DATA TBL CNTL SCREEN (PMC-SB7: K900.7, PMC-SA1: K17.7)
Not checked : Displays the PMC parameter data table control screen.
Checked : Hides the PMC parameter data table control screen.
- SIGNAL TRIGGER START (PMC-SB7: K901.2, PMC-SA1: K18.8)
Not checked : The trigger stop function does not automatically start when the power is turned on.
Checked : The trigger stop function automatically starts when the power is turned on.
- EDIT ENABLE (PMC-SB7: K901.6, PMC-SA1: K18.6)
Not checked : Disables sequence program editing.
Checked : Enables sequence program editing.

- WRITE TO F-ROM[EDIT] (PMC-SB7: K902.0, PMC-SA1: K19.0)
Not checked : After a Ladder program is edited, the changes will be automatically written to F-ROM.
Checked : After a Ladder program is edited, the changes will not be automatically written to F-ROM.
- ALLOW PMC STOP (PMC-SB7: K902.2, PMC-SA1: K19.2)
Not checked : Disables the sequence program execution/stopping operations.
Checked : Enables the sequence program execution/stopping operations.
- HIDE PMC PARAM (PMC-SB7: K902.6, PMC-SA1: K19.6)
Not checked : Enables the display and external output of PMC parameters.
Checked : Disables the display and external output of PMC parameters.
- PROTECT PMC PARAM (PMC-SB7: K902.7, PMC-SA1: K19.7)
Not checked : Enables the modification and reading of PMC parameters.
Checked : Disables the modification and reading of PMC parameters.
- IO GROUP SELECTION (PMC-SB7: K906.1)
Not checked : Hides the I/O link group selection screen.
Checked : Displays the I/O link group selection screen.

 CAUTION

The [Display] button can be used if the following conditions are satisfied:

- The selectable I/O link assignment screen on the system parameter screen is enabled.
- IO GROUP SELECTION (K906.1=1) is checked and PROGRAMMABLE ENABLE (K900.1=1) is also checked.

9.3.6.4 Warning message

When you click the [Display] button to call the setting parameter screen of the selectable I/O link assignment function, the following warning screen appears first to warn you against the modification of parameters.

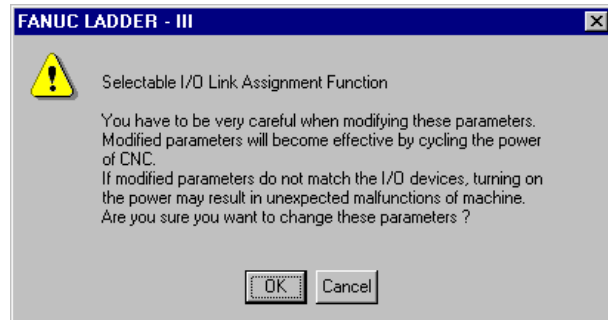

Fig. 9.3.6.4

OK

Displays the selectable I/O link assignment function.

Cancel

Returns you to the SETTING screen for PMC setting parameters.



WARNING

If you modify these parameters inadvertently, The I/O device configuration may not match the I/O assignment data, possibly causing the machine to perform an unexpected operation after the power is turned on. These parameters are assumed to be modified only by those operators who are familiar with the operation of sequence programs and that of the PMC. This setting screen must be protected with the programmer protect function so that the settings on the screen are not inadvertently changed by regular operators after the machine has been shipped to the field.

9.3.6.5 Setting screen of the selectable I/O link assignment function

On this setting screen, set the unique group of I/O devices to be connected to each machine.

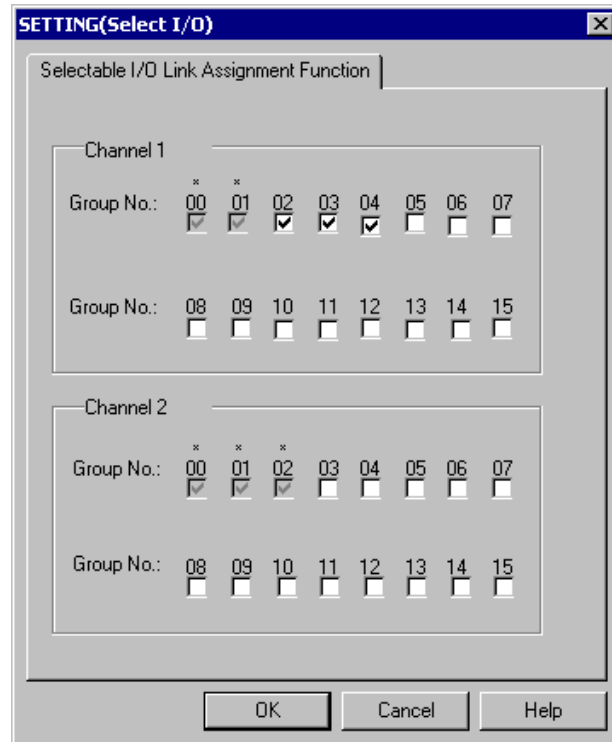

Fig. 9.3.6.5

Channel 1

Select the group to which the I/O link assignment data for channel 1 is to be made valid.

Checked : The assignment data is valid.

Not checked : The assignment data is invalid.

Channel 2

Select the group to which the I/O link assignment data for channel 2 is to be made valid.

Checked : The assignment data is valid.

Not checked : The assignment data is invalid.

NOTE

- 1 The basic groups that have been specified for each "Basic Group Count" on the system parameter screen will have their numbers displayed gray with an asterisk mark (*) shown above them. These groups are noneligible for this settings.
- 2 Channels for which the "selectable I/O link assignment function" is disabled on the system parameter screen are displayed gray. These channels are noneligible for this setting.
- 3 When you click the [OK] button, the warning message shown in Subjection 9.3.6.3 reappears. To reflect the settings to the keep relays, click the [OK] button below the warning message.

9.4 PMC ALARM STATUS

PMC alarm messages are displayed.

9.4.1 Procedure

1. Select [Diagnose] - [PMC Alarm Status]. The [PMC Alarm Status] screen appears.

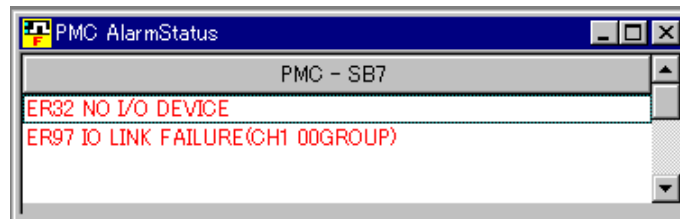

Fig. 9.4(a)

◆ Multi-path PMC

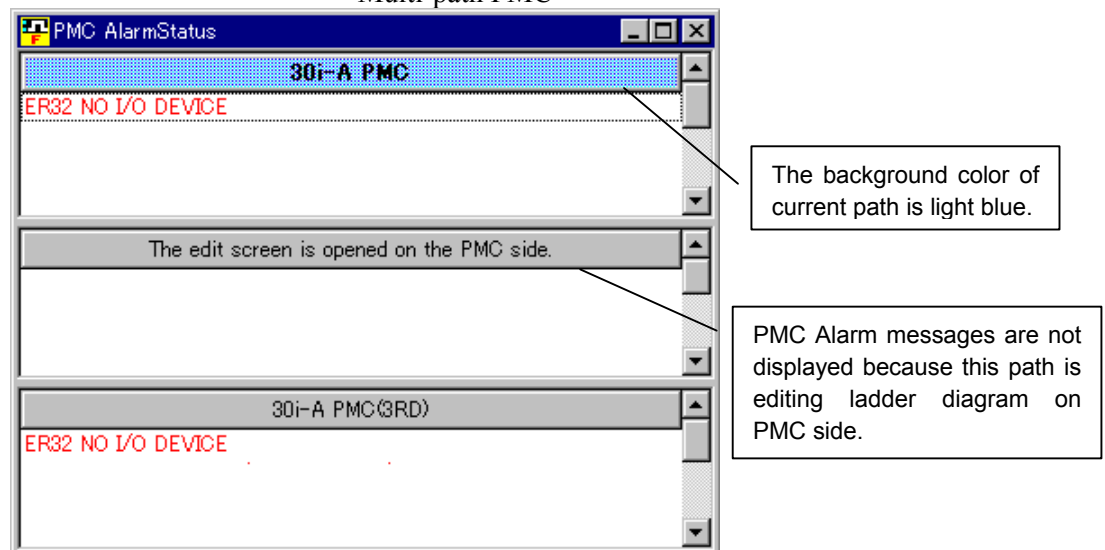

Fig. 9.4(b)

NOTE

- 1 For details on PMC alarm messages, refer to the ladder language programming manual.
- 2 You can switch the language in which PMC alarm messages are displayed.
 - (1) Select [Tool] - [Options].
 - (2) Select a language from "PMC alarm language" in Display tab.

9.4.2 Switching the Language in which PMC Alarm Messages are Displayed

You can switch the language in which PMC alarm messages are displayed.

Procedure

1. Select [Tool] - [Options].
2. Select a language from "PMC alarm language".

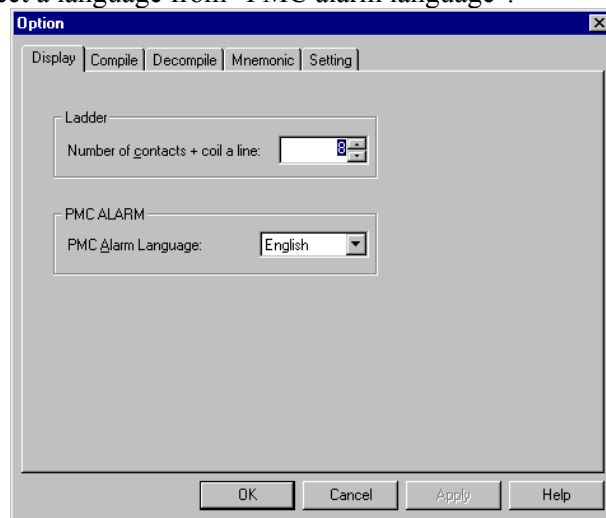

Fig.9.4.2

9.5 PMC STATUS

The PMC program status is displayed.

9.5.1 Procedure

1. Select [Diagnose] - [PMC Status]. The [[PMC Status] screen appears.

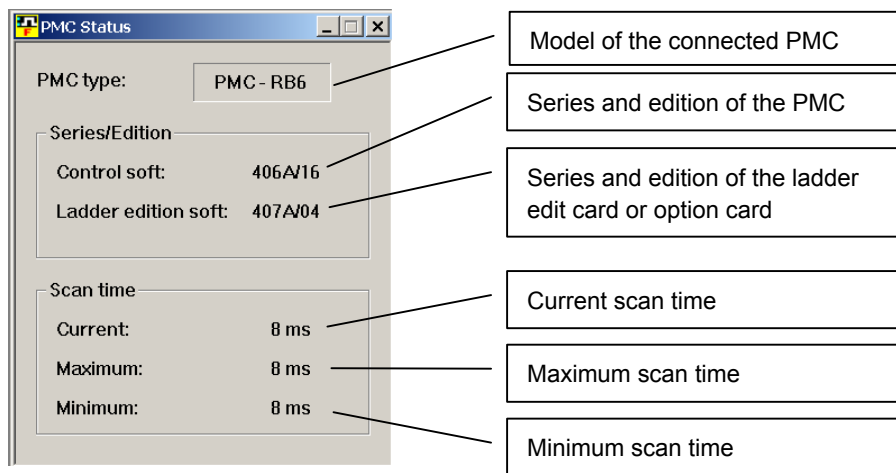

Fig. 9.5 (a)

- Multi-path PMC

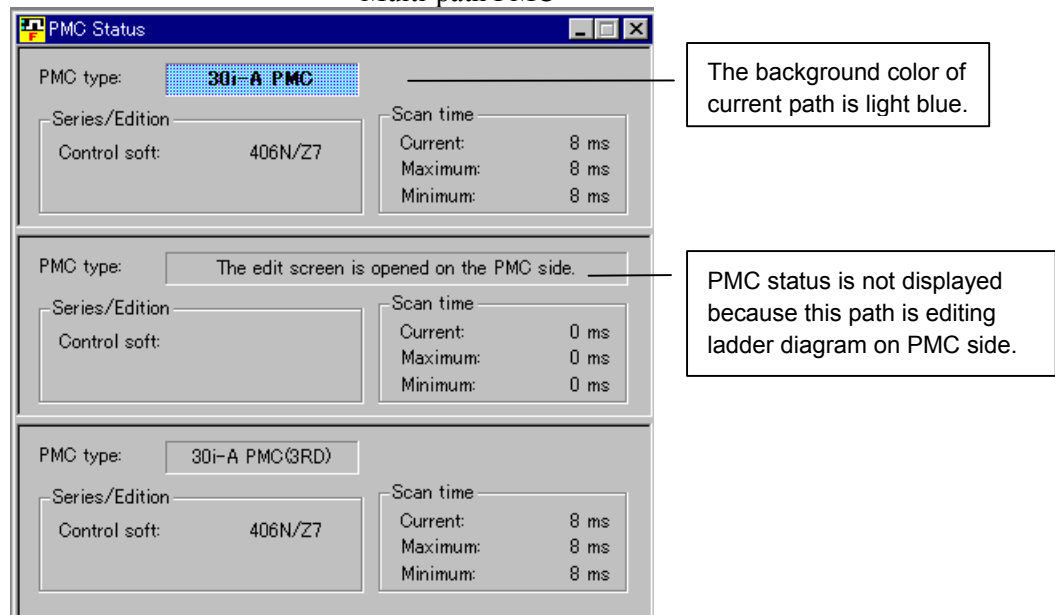

Fig. 9.5 (b)

9.5.2 Display Items

- PMC type
Model of the connected PMC
- Series and edition: Control software
Series and edition of the PMC
- Series and edition: Ladder edit software (option board)
Series and edition of the ladder edit card or option card
- Scan time: Current
Current scan time
- Scan time: Maximum
Maximum scan time
- Scan time: Minimum
Minimum scan time

9.6 SIGNAL TRACING

Changes in arbitrary signals are displayed on the screen. Signals are traced one or two bytes at a time. For one-byte tracing, two addresses can be traced at the same time. Up to 512 items can be displayed for one-byte tracing. For two-byte tracing, up to 256 items can be displayed.

9.6.1 Procedure

1. Select [Diagnose] - [Trace].
The [Select Function] screen of the trace function appears.

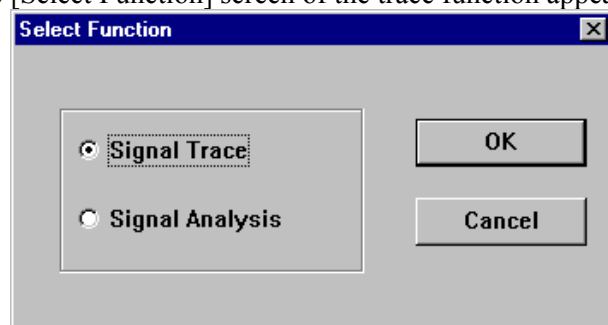

Fig. 9.6.1(a)

2. Select the [Signal Trace] radio button and click the <OK> button.
The [Signal Trace] screen appears.

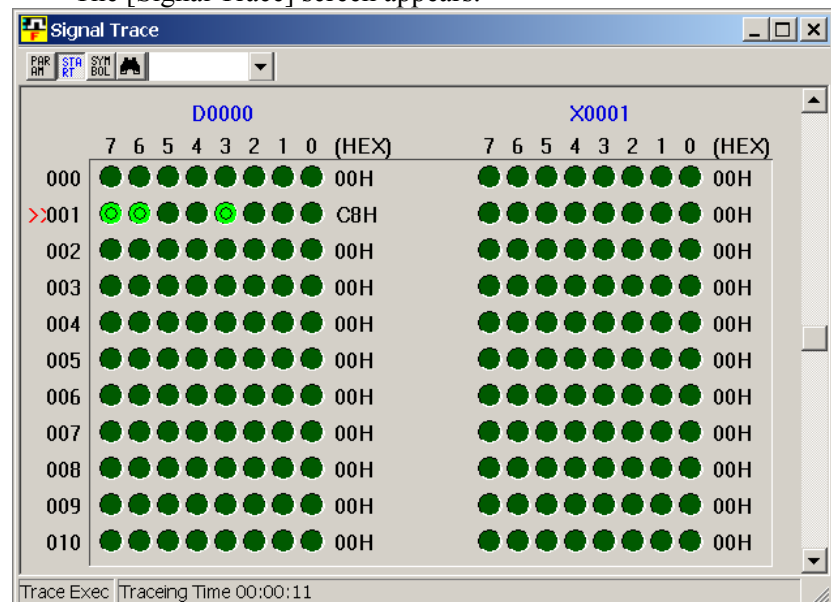

Fig. 9.6.1(b)

3. Click the <Parameter> button.
The [Signal Trace Parameter] screen appears.



<Parameter button>

4. Set data on the [Signal Trace Parameter] screen.
See Subsection 9.6.6, "[Signal Trace Parameter] Screen."
5. Click the <Start> button. The <Start> button enters the down state, and signal tracing starts.



<Start button>

6. To terminate tracing, click the <Start> button again. The <Start> button then enters the up state, and signal tracing terminates.

- Signal status indication
 - The signal is off.
 - The signal is on.
- Mask bit name indication

The numbers of the bits to be detected are indicated with bold characters.

The numbers of the bits not to be detected are indicated with grayed characters.

Example: When the signals on bits 4 to 7 are detected, and bits 0 to 3 are masked

R9028

7 6 5 4 3 2 1 0

9.6.2 Toolbar



<1> <2> <3> <4> <5>

Fig. 9.6.2

- <1> Parameter
- <2> Start and stop of tracing
- <3> Symbol indication
- <4> Number search
- <5> Combo box for inputting the character string for number search

9.6.3 Status Bar



Fig. 9.6.3

- <1> Status
[Tracing Exec] or [Trace Stop] is displayed.
- <2> Elapsed time

9.6.4 Context Menu

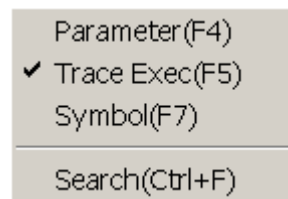

Fig. 9.6.4

9.6.5 Shortcut Keys

Table 9.6.5

Shortcut key	Corresponding function
[F3]	Number search
[F4]	Displays the [Parameter] screen.
[F5]	Starts and stops tracing.
[Ctrl]+[F]	Number search
[Ctrl]+[Home]	Displays data from the beginning.
[Ctrl]+[End]	Displays data from the end.

9.6.6 [Signal Trace Parameter] Screen

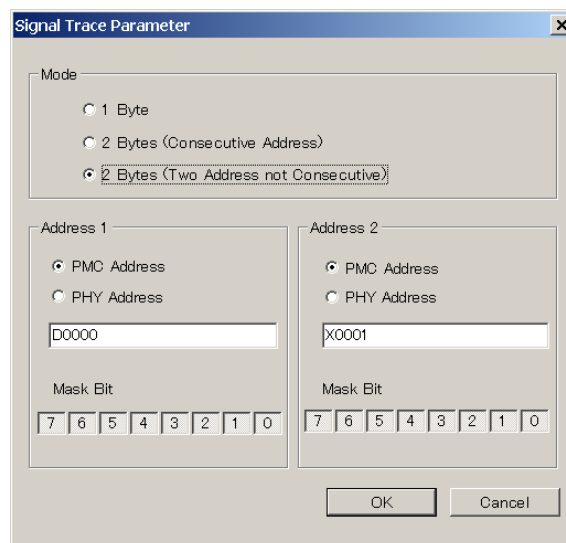

Fig. 9.6.6

Mode

Signal data length (in bytes)

Address Type

PMC address or physical address

Address

Address for signal tracing of a specified address type

Mask Bit

Specify the bits of the signals that need not be traced.
(The buttons of the signals to be traced are in the down state.)

The parameter settings become valid when the execution of signal tracing is selected.

NOTE

- 1 While the signal analysis function is being used, the signal trace function cannot be used.
- 2 During online monitoring, the PMC signal trace screen cannot be displayed.

**CAUTION**

When the address type is physical address, starting tracing with an illegal memory address specified may result in a system error. To specify a valid physical address, the user needs to be familiar with PMC programming in C language. Refer to the "C language Programming Manual" (B-61863E-1), and specify a valid memory address.

9.6.7 Automatic Trace Function at Power-On

If trace parameters are set, and [Signal Trace Start] is selected on the [Set Up] screen for PMC parameters, tracing will start automatically when the power to the CNC is turned on.

9.7 SIGNAL ANALYSIS

The ladder signal status is sampled and displayed along with the time axis. Trigger conditions can also be set.

9.7.1 Procedure

1. Select [Diagnose] - [Trace].
The [Select Function] screen of the trace function appears.

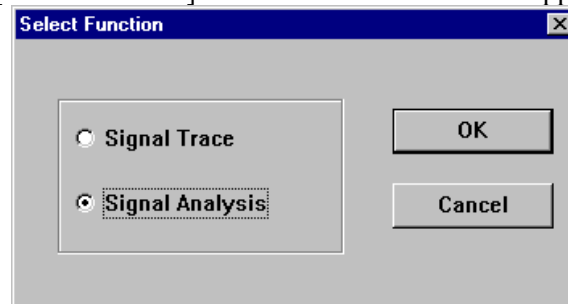

Fig. 9.7.1(a)

2. Select the [Signal Analysis] radio button and click the <OK> button.
The [Signal Analysis] screen appears.

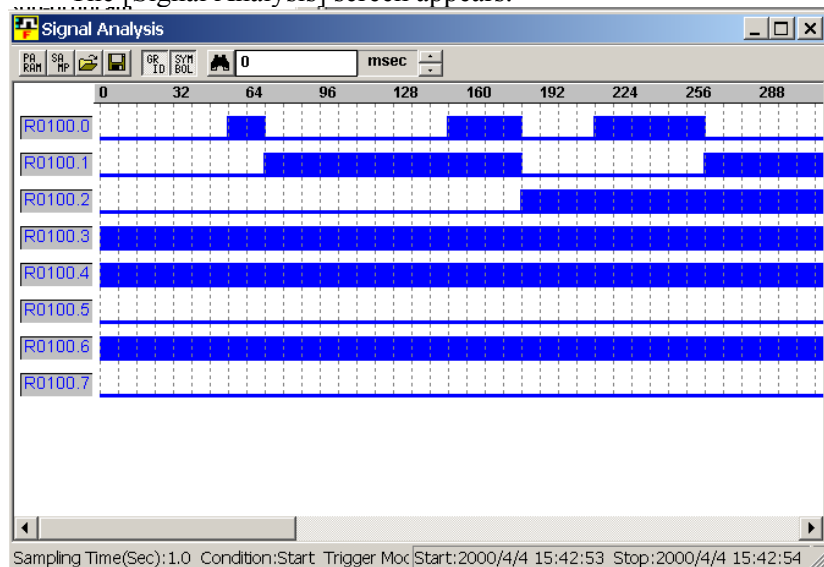

Fig. 9.7.1(b)

3. Click the <Parameter> button.
The [Signal Analysis Parameter] screen appears.



<Parameter button>

4. Set data on the [Signal Analysis Parameters] screen.
See Subsection 9.7.6, [Signal Analysis Parameter] screen.

5. Click the <Sampling> button. The <Sampling> button then enters the down state, and sampling starts.



<Sampling button>

6. To terminate sampling, click the <Sampling> button again. The button enters the up state, and sampling terminates.
- Maximum number of signals sampled simultaneously: 16
 - Sampling interval: 8 or 4 msec
 - Maximum sampling period:
10 sec (when the sampling interval is set to 8 msec)
5 sec (when the sampling interval is set to 4 msec)

9.7.2 Toolbar



Fig. 9.7.2

- <1> Parameter
<2> Start and stop of sampling

NOTE

- 1 While the signal analysis function is being executed, the signal trace function cannot be used. If the <Sampling> button is clicked during signal tracing, a message box appears, indicating "Signal Trace function is running."
- 2 When the automatic signal read function is executed at power-on, the displayed button is in the down state, which indicates that sampling is in progress.

- <3> Open File
Reads a signal analysis data file, and then displays waveforms. The extension of signal analysis data files is SAN.
- <4> Save As
Saves signal analysis data in a file with a file name specified (extension: SAN).
- <5> Grid line on/off
Specifies whether to display grid lines.
When no grid line is displayed, the button is in the up state; when grid lines are displayed, the button is in the down state.
The color and line style of grid lines are set from the context menu which is displayed by right-clicking a displayed grid line.
- <6> Symbol on/off
Sets the display format of the trigger and sampling addresses.
When the symbol format is selected, the button is in the down state; when the address format is selected, the button is in the up state.

- <7> Search
Moves through the signal analysis area with a specified search time.
- <8> Text box for inputting the character string for which a search is to be made
Specifies the search time.
- <9> Search character string increase/decrease button
Increases or decreases the search time in grid setting time units.

9.7.3 Status Bar



Fig. 9.7.3

<1> to <6> are displayed when sampling terminates.
During sampling, [Executing] is indicated.

- <1> Sampling time
- <2> Condition
- <3> Trigger mode
- <4> Trigger address
- <5> Sampling start time
- <6> Sampling end time
- <7> The current mouse position is indicated as the time (msec) on the signal analysis display.

9.7.4 Context Menu

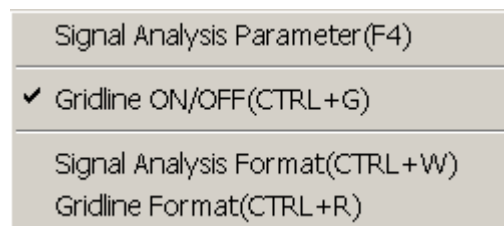

Fig. 9.7.4

9.7.5 Shortcut Keys

Table 9.7.5

Shortcut key	Corresponding function
[F3]	Sampling time search
[F4]	Displays the [Parameters] screen.
[F5]	Starts and stops sampling.
[Ctrl]+[Shift]+[O]	Opens an existing signal analysis file.
[Ctrl]+[Shift]+[A]	Saves data with a name.
[Ctrl]+[G]	Displays/does not display grid lines.
[Ctrl]+[R]	Sets the grid line format.
[Ctrl]+[W]	Sets the signal waveform format.
[Ctrl]+[Home]	Scrolls to the beginning of the signal analysis display.
[Ctrl]+[End]	Scrolls to the end of the signal analysis display.
PageUp	Scrolls the signal analysis display up by 1/2 page.
PageDown	Scrolls the signal analysis display down by 1/2 page.
[↑]	Scrolls the signal analysis display up by one line.
[↓]	Scrolls the signal analysis display down by one line.
[→]	Scrolls to the right by one sampling interval (8 or 4 msec).
[←]	Scrolls to the left by one sampling interval (8 or 4 msec).
[Home]	Scrolls to the beginning of the line.
[End]	Scrolls to the end of the line.

9.7.6 [Signal Analysis Parameter] Screen

Fig. 9.7.6

Sampling Time

Set the maximum sampling time.

When the sampling interval is 8 msec, set one to 10 sec (in 0.1-sec increments).

When the sampling interval is 4 msec, set one to five sec (in 0.1-sec increments).

Trigger Address

Set the trigger bit address at which sampling starts, with a PMC address or symbol.

Condition

Condition for starting sampling

Start: Sampling start button on the toolbar

Trigger-ON: Sampling start button + rising edge at the trigger address

Trigger-OFF: Sampling start button + falling edge at the trigger address

NOTE

When Trigger-ON or Trigger-OFF is selected with no trigger address set, a message box appears, indicating "No Trigger Address."

Trigger Mode

There is a buffer for holding data sampled for up to 10 seconds when the signal status is read at 8-msec intervals. (When the signal status is read at 4-ms intervals, the buffer can hold data sampled over five seconds.)

In trigger mode, the read start and end points are specified.

After: The signal status after the trigger address meets the trigger condition is read until the sampling time elapses.

About: The signal status around the time at which the trigger address satisfies the trigger condition is read within the sampling time.

Before: The signal status from when the <Sampling> button on the tool bar is pressed until the trigger address satisfies the trigger condition is read for up to the sampling time.

Only: The signal status when the trigger address satisfies the trigger condition is read.

NOTE

When About or Before is selected with the condition set to Start, a message box appears, indicating "[About]/[Before] is illegal on [Start] selected."

Signal Address

Set up to 16 sampling addresses with PMC addresses or symbols.

To reset the settings to the default values, click the <RESET> button.

Table 9.7.6

Default	
Sampling Time	10 sec
Trigger Address	Not set
Condition	Start
Trigger Mode	After
Signal Address	Not set

Once the settings are complete (the <OK> button is pressed), the trigger address and diagnosis address setting information is stored in the Windows registry on the disk. When the dialog box is next opened, the registry is read, and the previously made settings are restored in the list of the combo box.

9.7.7 [Signal Analysis Format] Screen

When [Signal Analysis Format] is selected from the context menu, the [Signal Analysis Format] screen appears.

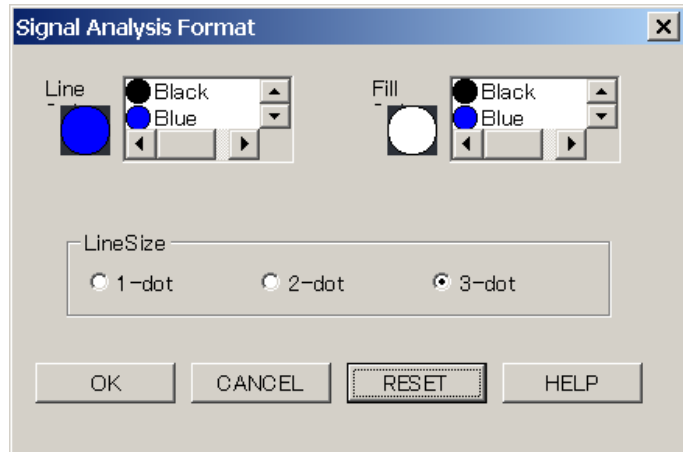

Fig. 9.7.7

Line Color, Fill Color

Choose from the following 16 colors:

Black, blue, light blue, light green, pink, red, yellow, white, dark blue, peacock blue, green, purple, dark red, dark yellow, 50% gray, 25% gray

Line Size

1 dot, 2 dots, or 3 dots

To reset the settings to the defaults, click the <RESET> button.

Table 9.7.7

Default	
Line Color	Blue
Fill Color	White
Line Size	3 dots

9.7.8 [Gridline Format] Screen

When [Gridline Format] is selected from the context menu, the [Gridline Format] screen appears.

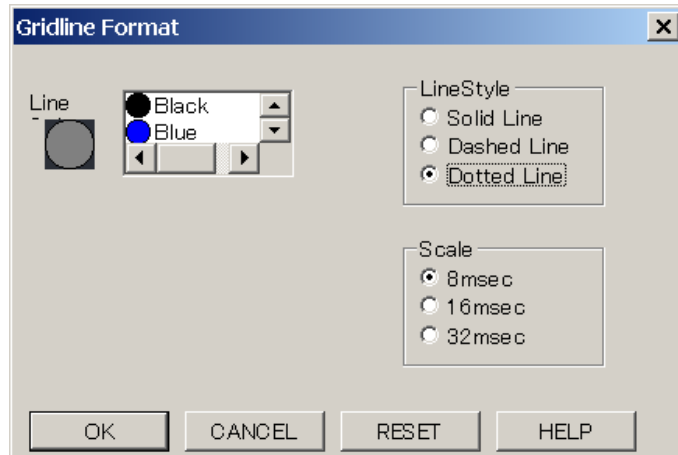

Fig. 9.7.8

Line Color

Choose from the following 16 colors:
Black, blue, light blue, light green, pink, red, yellow, white, dark blue, peacock blue, green, purple, dark red, dark yellow, 50% gray, 25% gray

Line Style

Solid line, dotted line, or dashed line

Scale

When the sampling interval is 8 msec:
8 msec, 16 msec, or 32 msec
When the sampling interval is 4 msec:
4 msec, 8 msec, or 16 msec
When the trigger mode is ONLY:
1 time, 2 times or 4 times

To reset the settings to the defaults, click the <RESET> button.

Table 9.7.8

Default	
Line Color	50% gray
Line Style	Solid line
Scale	8 msec (4 msec, 1 time)

9.7.9 Automatic Signal Sampling Function at Power-On

If sampling parameters are set, then [Signal Analysis Start] is checked on the [Set Up] screen for PMC parameters, sampling will start automatically when the power to the CNC is turned on.

9.8 CLEARING PMC AREAS

Addresses G, Y, N, A, R, and S can be cleared.

9.8.1 Procedure

- 1 Select [Tool] - [Clear PMC Memory].
The [Clear PMC memory] screen appears.

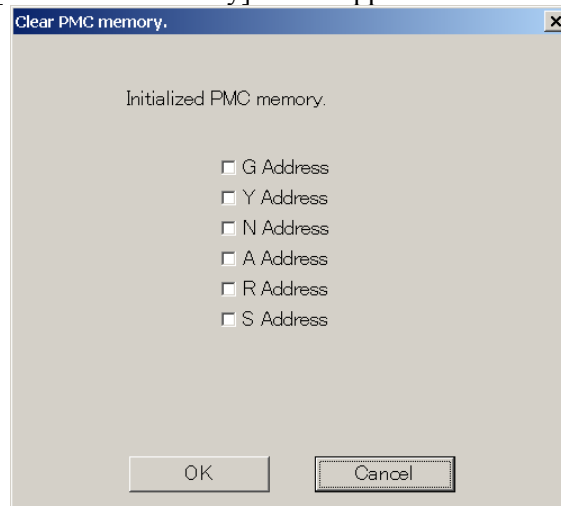

Fig. 9.8.1

- 2 To clear the PMC area, click the <OK> button.
To cancel the clear operation, click the <Cancel> button.



WARNING

When PMC areas are cleared, special care must be taken.

Clearing a PMC area may cause unpredictable machine operation. When there are people near the machine, this function should not be used.



CAUTION

On PMC-SB7, E Address is added below Initialized PMC memory.

9.9 ACTIVATING THE I/O Link

9.9.1 Procedure

- 1 Select the [Tool] - [I/O Link Restart].
The [I/O Link Restart] screen appears.

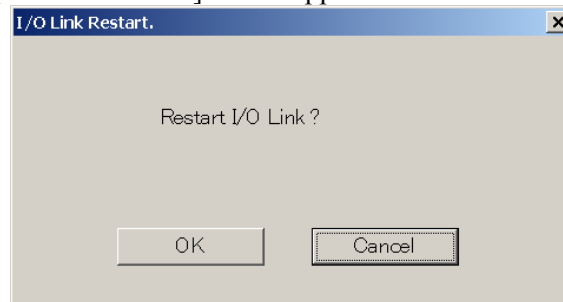

Fig. 9.9.1

- 2 To activate the I/O Link, click the <OK> button.
To cancel the activation of the I/O Link, click the <Cancel> button.



WARNING

When the I/O Link is activated, special care must be taken.
Setting I/O module data may cause unpredictable machine operation. When there are people near the machine, this function should not be used.

9.10 SIGNAL TRACE FUNCTION

For the PMC-SB7 and 30i/31i/32i-A PMC, the screen specifications of the signal trace function and signal analysis function of the PMC-SA5/SB5/SB6 are integrated to improve operability and functionality.

9.10.1 Procedure

1. Select [Diagnose] - [Trace].
The [Signal Trace] screen appears.

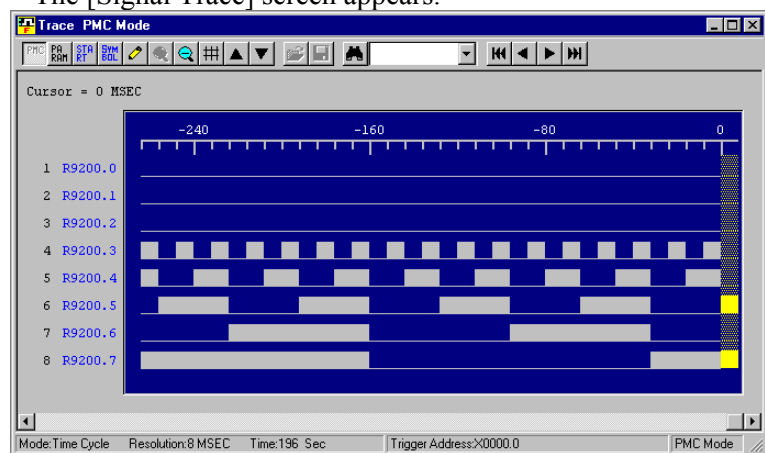



Fig. 9.10.1

2. Click the <Parameter> button.
The [Trace Parameter Setting] screen appears.

<Parameter> button
3. On the [Trace Parameter Setting] screen, set data.
See Subsection 9.10.4, "Setting Trace Parameters," for details.
4. Click the <Start> button. The button enters the down state, and signal tracing starts.

<Start> button
5. To terminate tracing, click the <Start> button again. The button enters the up state, and signal tracing terminates.

9.10.2 Toolbar



- <1> Trace parameter setting button
Displays the [Trace Parameter Setting] dialog box.
- <2> Trace start button
Starts or stops tracing.
When this button is in the up state, tracing is stopped.
When the button is in the down state, tracing is executed.
* When the trace function is being executed, the <Trace start> button is in the down state.
- <3> Symbol on/off button
Sets the display format of the trigger and sampling addresses.
When the symbol format is selected, the button is in the down state; when the address format is selected, the button is in the up state.
- <4> Marking button
Marks the cursor position at that time and displays the mark cursor. When the mark cursor and current position cursor overlap one another, the current position cursor is displayed. At the bottom of the screen, [Mark position], the mark cursor position, and [Range], the range from the mark cursor position to the current position cursor, are displayed.
- <5><6> Zoom button
Magnifies or reduces graphs.
- <7> Grid line button
Specifies whether to display grid lines.
- <8><9> Up-and-down replacement button
Clicking the [UP] button replaces the trace result at the address cursor with the line immediately above.
Similarly, clicking the [DOWN] button replaces the trace result with the line immediately below.
The display after replacement is held until the next execution of tracing.
- <10> Search button
Searches the trace display area for the specified time or frame number.
- <11> First trace result button
Moves the cursor at the beginning of the trace result.
- <12> Previous trace result button
Scrolls the trace result display up by one page.
- <13> Next trace result button
Scrolls the trace result display down by one page.
- <14> Last trace result button
Moves the cursor at the end of the trace result.

9.10.3 Status Bar

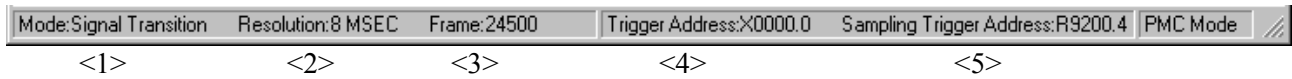

- <1> Sampling mode
The current selected sampling mode is indicated.
- <2> Resolution
The current resolution setting is indicated.
- <3> Frame
The current setting of the number of sampling frames is indicated.
- <4> Trigger address
The current setting of the sampling stop trigger address is indicated.
- <5> Sampling trigger address
The current setting of the sampling trigger address is indicated.

9.10.4 Setting Trace Parameters

Clicking the <Parameter> button displays the [Trace Parameter Setting] dialog box.

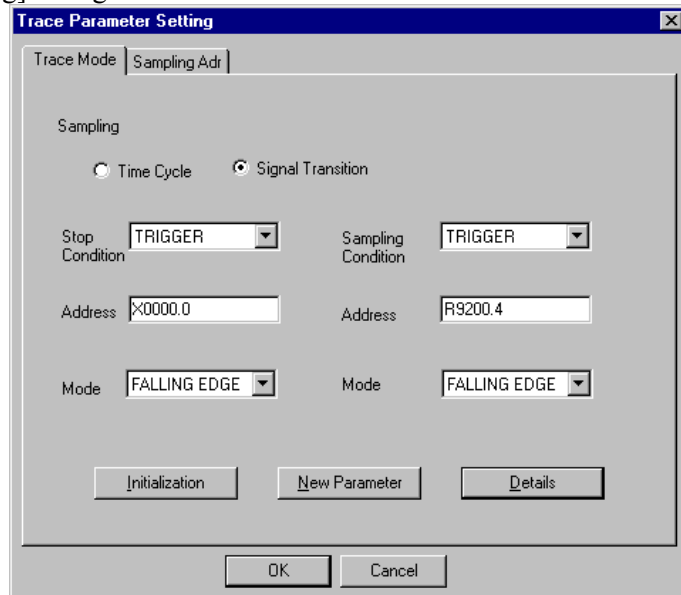

Fig. 9.10.4

Sampling

Set the sampling mode by clicking the corresponding radio button.

Time Cycle : Samples data in cycles.

Signal Transition : Samples signal transition.

Stop Condition

Set a tracing stop condition by selecting it from the list in the combo box.

None : Does not stop automatically.

BUFFER FULL : Automatically stops when the sampling buffer becomes full.

TRIGGER : Automatically stops at a trigger.

Trigger Address

This item can be set when the tracing stop condition is [TRIGGER]. Set the trigger address at which tracing stops.

Trigger Mode

This item can be set when the tracing stop condition is [TRIGGER]. Set the trigger mode for stopping tracing.

RISING EDGE : Automatically stops at the rising edge of the trigger signal.

FALLING EDGE : Automatically stops at the falling edge of the trigger signal.

BOTH EDGE : Automatically stops when the trigger signal status changes.

Sampling Condition

This item can be set when the sampling mode is [Signal Transition]. Set the sampling condition.

TRIGGER : Samples data when the sampling trigger condition is satisfied.

BOTH EDGE : Samples data when the sampling address signal changes.

Sampling Trigger Address

This item can be set when the sampling mode is [Signal Transition] and the sampling condition is [TRIGGER]. Set the address at which sampling is to be triggered.

Sampling Trigger Mode

This item can be set when the sampling mode is [Signal Transition] and the sampling condition is [TRIGGER]. Set the trigger condition mode.

RISING EDGE : Samples data at the rising edge of the trigger signal.

FALLING EDGE : Samples data at the falling edge of the trigger signal.

BOTH EDGE : Samples data when the trigger signal status changes.

ON : Samples data when the trigger signal is on.

OFF : Samples data when the trigger signal is off.

Initialization button

Initializes the trace parameters in the PMC.

New Parameter button

Obtains the current PMC trace parameters.

Details button

Displays the [Trace Mode Details Parameter] dialog box.

OK

Stores the settings and closes the dialog box.

Cancel

Closes the dialog box without storing the settings.

9.10.5 Setting Details of Trace Mode

Clicking the <Details> button displays the [Trace Mode Details Parameter] dialog box.

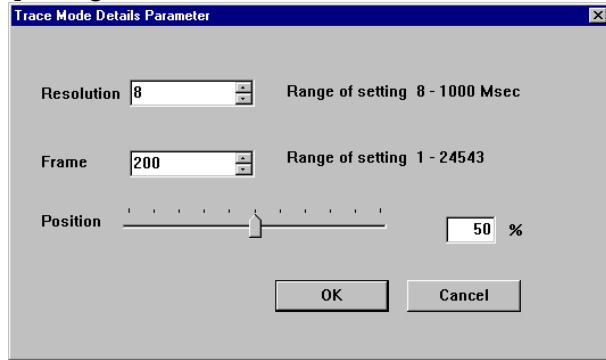

Fig. 9.10.5(a)

Resolution

Sets the sampling resolution. The default value is 8 msec.
 Setting range : 8msec to 1000msec
 The input value is rounded down to the nearest multiple of 8.

Frame

This item is displayed when [Signal Transition] is selected for the sampling mode. Set the number of samplings.
 The valid data range of this item varies depending on the setting of [Resolution] and the number of signals to be sampled. The valid data range is displayed in the dialog box.

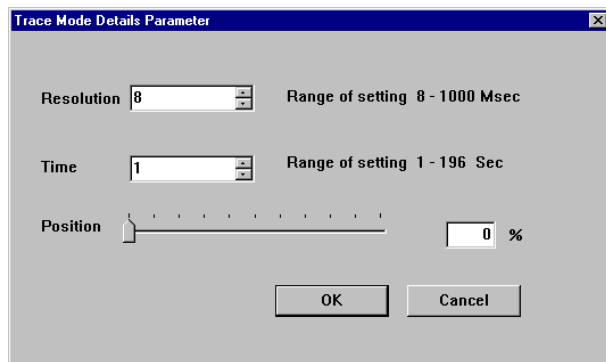

Fig. 9.10.5(b)

Time

This item is displayed when [Time Cycle] is selected for the sampling mode. Set the sampling time. The valid data range of this item varies depending on the setting of [Resolution] and the number of signals to be sampled. The valid data range is displayed in the dialog box.

Stop Trigger Position

This item is displayed when the tracing stop condition is [TRIGGER]. Specify where the time at which the stop trigger condition is satisfied is placed during the entire sampling time (or count) with the ratio of the time to the sampling time (or count). Set the ratio according to the purpose. For example, to check the signal changes before the trigger condition is satisfied, set a large value; to check the signal changes after the trigger condition is satisfied, set a small value.

Example

Graph display range when the sampling time is 10 sec and the sampling position is 10%:

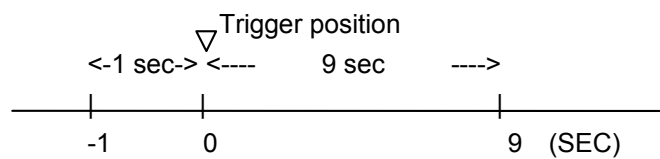

OK

Stores the settings and closes the dialog box.

Cancel

Closes the dialog box without storing the settings.

9.10.6 Setting Trace Parameters (Sampling Addresses)

In the [Trace Parameter Setting] dialog box, clicking the [Sampling Adr] tab displays the Sampling address setting screen.

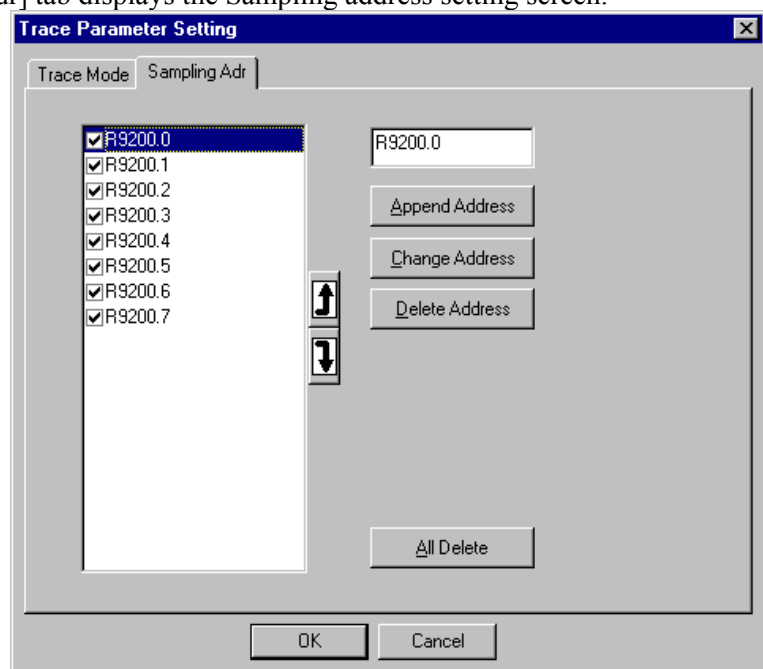

Fig. 9.10.6

Edit Box of Address Setting

Enter the address or symbol of a signal to be sampled in the edit box and click the <Append Address> button. The address or symbol is added to the list box. Set a signal address with a bit address. If a byte address is entered, the address indicated by bits 0 to 7 of the entered address is input. Up to 32 signal addresses can be set.

Sampling Address List

When the trace sampling mode is [Signal Transition] and the sampling condition is [ANY CHANGE], you can specify whether to use each set address as a sampling trigger signal. Check the check box corresponding to a desired signal to use the signal as a sampling trigger signal.

Append Address button

Adds the new sampling address entered in the edit box.

Change Address button

Replaces the set address or symbol at the cursor with the contents of the edit box.

Delete Address button

Deletes the set address or symbol at the cursor from the list box.

All Delete button

Deletes all sampling addresses set in the list box.



button

Replaces the set address at the cursor with the address on the line immediately above.



button

Replaces the set address at the cursor with the address on the line immediately below.



OK

Stores the settings and closes the dialog box.

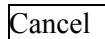

Cancel

Closes the dialog box without storing the settings.

9.10.7 Context Menu

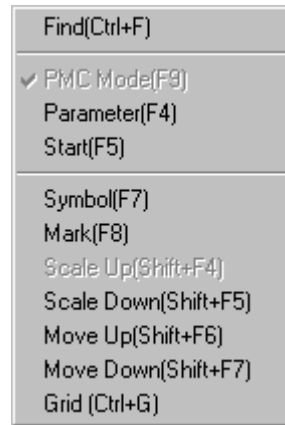

Fig. 9.10.7

9.10.8 Shortcut Keys

Table 9.10.8

Shortcut key	Function
[F1]	Help
[F3]	Searches for the time or frame.
[F4]	Displays the [Parameter] screen.
[F5]	Starts or stops tracing.
[F7]	Displays symbols.
[F8]	Marking
[Shift]+[F4]	Zoom-in
[Shift]+[F5]	Zoom-out
[Shift]+[F6]	Moves the signal address up.
[Shift]+[F7]	Moves the signal address down.
[Ctrl]+[Home]	Moves to the beginning of the trace result.
[Ctrl]+[End]	Moves to the end of the trace result.
PageUp	Scrolls the signal address display up.
PageDown	Scrolls the signal address display down.
Ctrl + PageUp	Displays the trace result on the previous page.
Ctrl + PageDown	Displays the trace result on the next page.
Ctrl + G	Displays or does not display grid lines.
[↑]	Moves the address cursor one line up.
[↓]	Moves the address cursor one line down.
[→]	Moves the current position cursor right.
[←]	Moves the current position cursor left.
[Home]	Moves the address cursor to the start address.
[End]	Moves the address cursor to the end address.

9.10.9 Automatic Sampling Function at Power-on

By setting a PMC parameter, tracing can automatically be started at power-on. This setting can be made on the [Set Up] screen for PMC parameters.

Trace function start = 0 (0: Manual 1: Automatic)

10

COMMAND LINE EXECUTION FUNCTION

This chapter describes the command line execution function.

10.1 OUTLINE

You can specify a batch command file as an argument of an executable file of FANUC LADDER-III to automatically perform operations such as input and output of a source program, compilation and decompilation, and conversion to a mnemonic file.

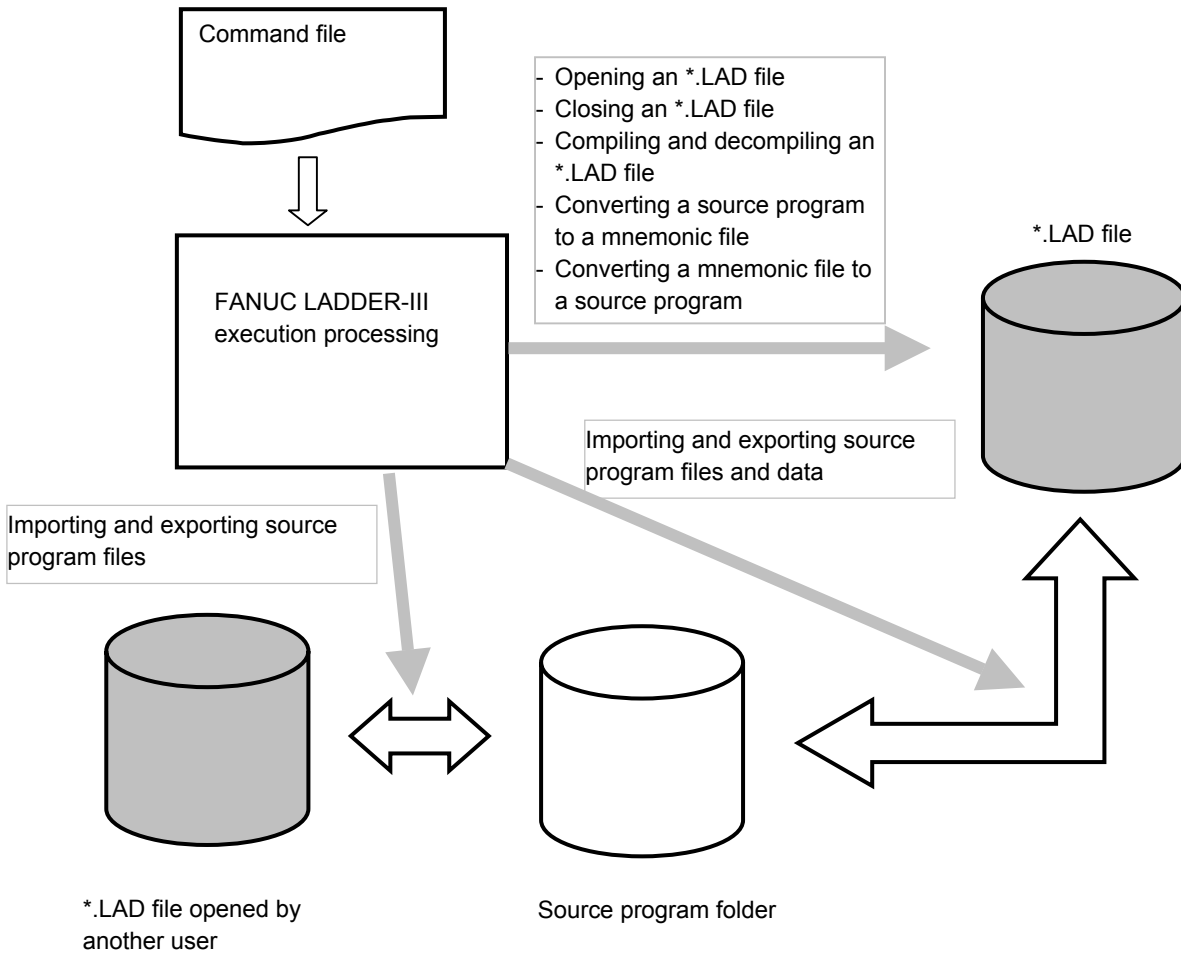

Fig. 10.1

10.2 PROCEDURE

Following an executable file of FANUC LADDER-III, specify the /cmdfile option and then a command file name to automatically perform batch processing. Create the command file using a general-purpose text editor in advance.

**Fladder.exe /cmdfile=[Drive:][Path]command file name
/cmdlog=[Drive:][Path]execution log file name**

Example) Fladder.exe /cmdfile=D:\TEST LADDER\Sample.cmd
/cmdlog=D:\TEST LADDER\Sample.log

You can specify the output destination of an execution log file with the /cmdlog option. If the /cmdlog option is omitted, an execution log file (COMMANDLOG.TXT) is created on the same directory path as for the command file.

NOTE

To execute another command processing after completion of FANUC LADDER-III processing, execute the START command with the /WAIT option and call an executable file of FANUC LADDER-III.

START /WAIT Fladder.exe /cmdfile= [[Drive:][Path]command file name
/cmdlog=[Drive:][Path]execution log file name

Example) START /WAIT Fladder.exe /cmdfile=D:\TEST LADDER\Sample.cmd
/cmdlog=D:\TEST LADDER\Sample.log

10.3 COMMANDS

Table 10.3

Command	Function
FIOpen	Opens a LAD file.
FIclose	Closes a LAD file.
Compile	Compiles a LAD file.
DeCompile	Decompiles a LAD file.
SrcToMnemonic	Converts the source programs of a LAD file to a mnemonic file.
MnemonicToSrc	Converts a mnemonic file to a source program.
Import	Imports data from a file.
Export	Exports data to a file.
FINew	Creates a new LAD file.
FIChange	Changes the existing LAD file to a new LAD file of other PMC type.
End	Terminate command processing

10.4 COMMAND SPECIFICATIONS

10.4.1 Opening an *.LAD File

FIOpen [Drive:][Path]file name

Parameter

None

Explanation

Opens a ladder program for which to execute commands.

Note

None

10.4.2 Closing an *.LAD File

FIclose

Parameter

None

Explanation

Closes the ladder program for which commands have been executed.
The changes made by command processing are stored as is.

Note

None

10.4.3 Compiling an *.LAD File

Compile [/condense=0 | 1] [/symbol=0 | 1] [/longsym=0 | 1] [/netcmt=0 | 1]
 [/multi=0 | 1] [/password=0 | 1 | 2 | 3 [*string1*] [*string2*]] [/lang=0 | 1]

- Parameter

/condense =0 : Compiles the file not in the condense mode.
=1 : Compiles the file in the condense mode.

/symbol =0 : Outputs neither symbols nor comments.
=1 : Outputs symbols and comments.

/longsym =0 : Does not ignore too long strings of symbols.
=1 : Ignores too long strings of symbols.

/netcmt =0 : Outputs no net comment pointers.
=1 : Outputs net comment pointers.

/multi =0 : Does not check function parameter numbers for duplication.
=1 : Checks function parameter numbers for duplication.

/password =0 : Sets no passwords.
=1 : Sets a password to permit display and a password to permit display and editing.
=2 : Sets a password to permit display and editing.
=3 : Sets a password to permit display.

string1 : String of a password to permit display (up to eight characters)
string2 : String of a password to permit display and editing (up to eight characters)

/lang =0 : Use English as the coil comment language.
=1 : Use Japanese as the coil comment language.

- Explanation

Compiles the open ladder program.

- Note

- An error log (ERRORLOG.TXT) and a map log (MAP.TXT) are created on the directory path specified for the /cmdlog option. If the /cmdlog option is omitted, these logs are created on the same directory path as for the command file specified for the /cmdfile option.
- If FANUC LADDER-III is installed with a non-Japanese language specified as the use language, "/lang=1" cannot be set.

When the multiple comments are supported PMC

Compile [/symbol=0 | 1] [/comment=**] [/netcmt=0 | 1] [/multi=0 | 1]
 [/password=0 | 1 | 2 | 3 [string1] [string2]] [/mult_sym=0 | 1]

- Parameter

- /symbol** =0: Outputs neither symbols nor comments.
 =1: Outputs symbols and comments.(It sets up 1, when using a /comment parameter.)
- /comment** =10: Outputs no 1st comment.
 =11: Outputs 1st comment.
 =20: Outputs no 2ndt comment.
 =21: Outputs 2ndt comment.
 =30: Outputs no 3rdt comment.
 =31: Outputs 3rd comment.
 =40: Outputs no 4th comment.
 =41: Outputs 4th comment.
- If multiple comments are supported, this parameter is available.
 - It will output all comments, if this parameter is omitted.
 - It can specify two or more arguments with a comma(.).
 Ex.) /comment=11,21: Outputs 1st and 2nd comment.
 - The comment that omitted the argument of this parameter is not outputted.
 Ex.) /comment=11: Outputs 1st comment. Outputs no 2nd, 3rd and 4th comment.
 - When outputting only a symbol, it specifies as follows.
 Ex.) /comment=10,20,30,40: Outputs only symbol.
 - * When a comment is the PMC model that is 2 sets, the 3rd and 4th comment is disregarded.
- /netcmt** =0: Outputs no net comment pointers.
 =1: Outputs net comment pointers.
- /multi** =0: Does not check function parameter numbers for duplication.
 =1: Checks function parameter numbers for duplication.
- /password** =0: Sets no passwords.
 =1: Sets a password to permit display and a password to permit display and editing.
 =2: Sets a password to permit display and editing.
 =3: Sets a password to permit display.
 string1 : String of a password to permit display (up to eight characters)
 string2 : String of a password to permit display and editing (up to eight characters)

- /mult_sym =0**: Multiple use symbol defined to one address are not checked.
- =1**: Multiple use symbol defined to one address are checked.
- * This parameter is /mult_sym =0 when omitted.

10.4.4 Decompiling an *.LAD File

DeCompile [/sysmerge=0 | 1 | 2] [/password= *string*]

Parameter

- /sysmerge =0** : Merges no symbol/comment data.
- =1** : The source program is used for merging symbol/comment data.
- =2** : Memory card data is used for merging symbol/comment data.
- /password =string** (up to eight characters)
- When only a password to permit display was specified during execution of compilation, specify the password to permit display.
 - When passwords to permit display and to permit display and editing were specified during execution of compilation, specify the password to permit display and editing.
 - When only a password to permit display and editing was specified during execution of compilation, specify the password to permit display and editing.

Explanation

Decompiles the open ladder program.

Note

- An error log (ERRORLOG.TXT) and a map log (MAP.TXT) are created on the directory path specified for the /cmdlog option. If the /cmdlog option is omitted, these logs are created on the same directory path as for the command file specified for the /cmdfile option.

When the multiple comments are supported PMC

DeCompile [/sysmerge=0 | 1 | 2] [/symbol= 0 | 1] [/merge= **]
 [/password= string]

- Parameter

- /sysmerge** =0: Merges no symbol/comment data.
 =1: The source program is used for merging symbol/comment data.
 =2: Memory card data is used for merging symbol/comment data.
- /symbol** =0: It does not decompile symbol/comment data.
 =1: It decompile symbol/comment data
 - When this parameter is used together with "/sysmerge", the command specified last is effective.
 - Merge parameter is needed when "symbol=1" is specified.
- /merge** =0: New (it decompiles, after deleting existing symbol/comment) .
 =1: Source data are priority.
 =2: Memory card data are priority.
 =3,xxxxx
 It divides an argument with a comma(.). It describes in order of a symbol, the 1st comment, the 2nd comment, the 3rd comment, and the 4th comment.
 format : 3,xxxxx
 x = 0 : Source data are priority.
 1 : Memory card data are priority.
 =3,00000 The source data of merge of a symbol and the 1st, 2nd, 3rd, and 4th comment are priority.
 =3,11111 The memory card data of merge of a symbol and the 1st, 2nd, 3rd, and 4th comment are priority.
 Ex.) When memory card data are priority .
 /merge=2 : Memory card data are priority.
 Ex.) When detailed specificationThe source data of a symbol and the 1st, 3rd, and 4th comment are priority, and memory card data merge the 2nd comment by priority.
 /mrege=3,00100
 - When this parameter is used together with "/sysmerge", the command specified last is effective.
 - The argument of marge is not omissible.
 * When a comment is the PMC model that is 2 sets, the 3rd and 4th comment is disregarded.
- /password=string** - When only a password to permit display was specified during execution of compilation, specify the password to permit display.
 - When passwords to permit display and to permit display and editing were specified during execution of compilation, specify the password to permit display and editing.
 - When only a password to permit display and editing was specified during execution of compilation, specify the password to permit display and editing.

10.4.5 Converting the Source Program of an *.LAD File to a Mnemonic File

Converting the Source Program of an *.LAD File to a Mnemonic File

SrcToMnemonic [/datatype=**0** | **1** | **2** | **3** | **4** | **5** | **6**] [/mode=**0** | **1** | **2** | **3** | **4**]
 [/symspace=*character*]/file=[Drive:][Path]*file name*]

Parameter

/datatype =**0** : Converts all source programs.
 =**1** : Converts only system parameters.
 =**2** : Converts only title data.
 =**3** : Converts only symbol and comment data.
 =**4** : Converts only ladder program data.
 =**5** : Converts only I/O module data.
 =**6** : Converts only message data.
 * This parameter is /datatype=0 when omitted.

/mode =**0** : Converts data to P-G compatible data.
 =**1** : Converts data with in full option mode.
 =**2** : Converts data to label/subprogram format data.
 =**3** : Converts data to Japanese comment format data.
 =**4** : Converts data to extended function format data.
 * When 4 is specified from models other than extended function, an error occurs and processing is interrupted.
 * This parameter is /mode=0 when omitted.

/symspace =*character*: Specify the character of symbol to replace to white-space character.
 * If this parameter is omitted, the specified character of symbol is not replaced to white-space character.

/file =**[Drive:][Path]file name:**
 Specify the file name of a mnemonic file to be converted.

Explanation

Converts a ladder program opened by the FIOpen command to a mnemonic file.

Note

- The conversion log (FLMNE.TXT) is created on the directory path where the mnemonic file was created.
- The conversion log (FLMNE2.TXT) is created on the same directory path as with the converted mnemonic file. If this command is executed more than once in one command file, all logs are added to the conversion log (FLMNE2.TXT).
- When FANUC LADDER-III is installed with English selected, /mode=3 cannot be used.

10.4.6 Converting a Mnemonic File to the Source Program

MnemonicToSrc `[/warning=0 | 1] [/init=0 | 1 | 2 | 3 | 4 | 5 | 6] [/symospace=character]
[/file=[Drive:][Path]filename]`

Parameter

/warning =0 : Does not detail warning messages.

=1 : Details warning messages. (Default)

/init =0 : Initialize all source programs and delete all ladder programs before conversion.

=1 : Initialize system parameter before conversion.

=2 : Initialize title data before conversion.

=3 : Initialize symbol/comment before conversion.

=4 : Delete all ladder programs before conversion.

=5 : Initialize I/O module data before conversion.

=6 : Initialize message data before conversion.

/symospace =character: Specify the character of symbol to replace to white-space character.

* If this parameter is omitted, the specified character of symbol is not replaced to white-space character.

There is a case that the conversion not intended occurs by cyclic conversions (a mnemonic file <-> the source program), if the white-space character is included in the symbol. It is recommended that the white-space character should not be used in the symbol.

/file = [Drive:][Path]file name:

Specify the file name of a mnemonic file to be converted.

NOTE

- 1 If you want to initialize symbol/comment and all ladder programs, please specify "/init=3,4".
- 2 When /init=0 or /init=3 is not specified, symbol/comment is added.
- 3 When /init=0 or /init=4 is not specified, a net comment is added.
- 4 When the same subprogram is already present, a source program is always newly created from a mnemonic file.

Explanation

Source programs of the LAD file opened by command "FIOpen" are converted from the specified mnemonic file.

Note

- A conversion log (FLMNE.txt, FLMNE2.txt) is created on the same directory path as for the conversion mnemonic file. Even if this command is executed two or more times in a command file, all logs are appended to the same conversion log file (FLMNE2.TXT).

Example

After all source programs are initialized, new source programs are created.

```
>cd d:\mnemonic  
>start /wait fladder.exe /cmdfile=fl3_command.txt  
>start fladder.exe M_0123.LAD
```



```
FIOpen M_0123.LAD  
MnemonicToSrc /file=001_sysparam.txt /init=0  
MnemonicToSrc /file=002_title.txt  
MnemonicToSrc /file=003_Symbol.txt  
MnemonicToSrc /file=004_message.txt  
MnemonicToSrc /file=005_iomodule.txt  
MnemonicToSrc /file=006_level1_symbol.txt  
MnemonicToSrc /file=007_level1_ladder.txt  
MnemonicToSrc /file=008_level2_symbol.txt  
MnemonicToSrc /file=009_level2_ladder.txt  
MnemonicToSrc /file=010_p1_symbol.txt  
MnemonicToSrc /file=011_p1_ladder.txt  
FIClose  
End
```

10.4.7 Importing Data from the Specified File

1. Importing source files from the specified folder

```
Import [/Title | /Syspara | /Message | /Symbol=* | /IOModule | /NetCmt |
      /Ladder =**] [/Other=[Drive1:][Path1]file name]
      [Drive2:][Path2]
```

Parameter

/Title Imports the title data file (TITLE).

/Syspara Imports the system parameter file (SYSPARAM).

/Message Imports the message data file (MESSAGE).

/Symbol The Symbol and Comment data file “XSYMBOL.xxx” or “VARSYM” is replaced to the imported file.

/Symbol =01* : Merge priority is given to the source program data. (Detail log is not output)

=02 : Merge priority is given to the import data. (Detail log is not output)

=11 : Merge priority is given to the source program data. (Detail log is output)

=12 : Merge priority is given to the import data. (Detail log is output)

/IOModule Imports the I/O module data file (IOMODULE).

/NetCmt Imports the net comment data file (NETCMT.xxx).

/Ladder=*** Imports a ladder program file (***.#LA or ***.#SS).

- When only the /Ladder parameter is specified, all ladder program files are imported.
- For a main program, specify LEVEL1, LEVEL2, or LEVEL3 for ***.
- For a subprogram, specify a subprogram number such as P1 or P100 for ***.
- Two types of wildcards can be used: a question mark (?) and an asterisk (*).
A question mark (?) represents zero or one character. This wildcard can be used more than once to represent characters. An asterisk (*) represents zero or more characters.
(Example) Import /Ladder=LEVEL1 D:\LAD_SRC
Import /Ladder=P100 D:\LAD_SRC
Import /Ladder=P* D:\LAD_SRC

/Other=[Drive1:][Path1]file name
Imports source files to a program already opened on FANUC LADDER-III.
For [Drive1:][Path1]file name, specify the name of an *.LAD file already opened on FANUC LADDER-III.

[Drive2:][Path2]

Following the above parameter, enter a half-size space and specify the name of the file folder containing files to be imported.

Explanation

- Imports source program files from the file folder specified by [Drive2:][Path2] to the ladder program opened by the FIOpen command.
- When the name of a program already opened on FANUC LADDER-III is specified for the /Other option, imports the source program files to the ladder program.
- When only [Drive2:][Path2] is specified with inputting no parameter, imports all source files that can be specified with the above parameters from the specified folder.

Note

- If the PMC type is different, files cannot be imported.
- If a source program file having the name of a file to be imported is found in the open ladder program, the source program file is overwritten with the imported file.
- Any source program file cannot be imported to a ladder program with a special password specified.
- Any file cannot be imported to a program opened on another personal computer.
- The file name of each import source file must be the same as that of a format C file as shown below:
"TITLE", "SYSPARAM", "MESSAGE", "XSYMBOL.xxx",
"IOMODULE", "NETCMT.xxx", "***.#LA", "***.#SS"
- When the extended function is used, merging of symbol/comment data cannot be used.

2. Importing data from the specified file

Import [/MemData | /RomData | /HandyFile][Drive:][Path]file name

Parameter

/MemData Imports a memory card format file.

/RomData Imports a ROM format file.

/HandyFile Imports a Handy file format file.

[Drive:][Path]file name

Specify the file name of a file to be imported.

Explanation

Imports data from the file specified by [Drive:][Path]file name to the ladder program opened by the FIOpen command.

Note

- Data can be imported only from a data file created with the same type as for the open ladder program.
- Any data cannot be imported to a ladder program with a special password specified.

10.4.8 Exporting Data to the Specified File

1. Exporting source files to the specified folder

Export [/Title | /Syspara | /Message | /Symbol | /IOModule | /NetCmt | /Ladder =] [/Other=[Drive1:][Path1]file name][Drive2:][Path2]**

Parameter

/Title	Exports title data to the TITLE file.
/Syspara	Exports system parameters to the SYSPARAM file.
/Message	Exports message data to the MESSAGE file.
/Symbol	Exports symbol and comment data to the XSYMBOL.xxx file.
/IOModule	Exports I/O module data to the IOMODULE file.
/NetCmt	Exports net comment data to the NETCMT.xxx file.
/Ladder=***	Exports a ladder program to ***.#LA and ***.#SS files. <ul style="list-style-type: none"> - When only the /Ladder parameter is specified, the entire ladder program is specified. - For a main program, specify LEVEL1, LEVEL2, or LEVEL3 for ***. - For a subprogram, specify a subprogram number such as P1 or P100 for ***. - Two types of wildcards can be used: a question mark (?) and an asterisk (*). A question mark (?) represents zero or one character. This wildcard can be used more than once to represent characters. An asterisk (*) represents zero or more characters. (Example) Export /Ladder=LEVEL1 D:\LAD_SRC Export /Ladder=P100 D:\LAD_SRC Export /Ladder=P* D:\LAD_SRC
/Other=[Drive1:][Path1]file name	Exports source files from a program already opened on FANUC LADDER-III. For [Drive1:][Path1]file name, specify the name of an *.LAD file already opened on FANUC LADDER-III.
[Drive2:][Path2]	Following the above parameter, enter a half-size space and specify the name of the export destination file folder.

Explanation

- Exports source program files from the ladder program opened by the FIOpen command to the file folder specified by [Drive2:][Path2].
- When the name of a program already opened on FANUC LADDER-III is specified for the /Other option, exports source program files from the ladder program to the file folder specified by [Drive2:][Path2].
- When only [Drive2:][Path2] is specified with inputting no parameter, exports all source files that can be specified with the above parameters to the specified folder.

Note

- A format C source file name is attached to each exported file.
- If a file having the name of a source program file to be exported is found in the export destination file folder, the file is overwritten with the exported file.
- Any source program file cannot be exported from a ladder program with a special password specified.
- Any data cannot be exported to a program opened on another personal computer.

2. Exporting data to the specified file

Export [/MemData | /RomData | /HandyFile] [Drive:][Path]file name

Parameter

/MemData Exports a memory card format file.

/RomData Exports a ROM format file.

/HandyFile Exports a Handy file format file.

[Drive:][Path]file name

Specify the name of an export destination file.

Explanation

Exports data from the ladder program opened by the FIOpen command to the file specified by [Drive:][Path]file name.

Note

- If a file having the name of a data file to be exported is found in the export destination file folder, the file is overwritten with the exported file.

10.4.9 Creating a New *.LAD File

FINew [Drive:] [Path] file name [/Pmctype=*string*] [/ioexp=0 | 1] [/overwrite]

Parameter

[Drive:][Path] file name Specify the new LAD file name.
/Pmctype =string Specify the PMC type name (string) of new LAD file. See Table 10.4.10 (a).
/ioexp =0 : I/O LINK expansion function is disabled.
=1 : I/O LINK expansion function is enabled.
 * This parameter is /ioexp=0 when omitted.
/overwrite : Even if the LAD file has already existed, creates a new LAD file by overwrite.

Explanation

The "FLnew" command can enter PMC type and file name, and create a new LAD file.

Note

- "/Pmctype" parameter is not omissible.
- Do not use FINew command between FIOpen and FIClose.
- A log file (FLNEW.TXT) is created to the same directory path as the LAD file newly created. When a new LAD file cannot be created, the log file is created to same directory path as a command file.

Example

Create new LAD file of PMC-SB7, and convert the mnemonic file to the source program.

```
Flnew New-PRG.LAD /Pmctype=PMC-SB7
FIOpen New-PRG.LAD
MnemonicToSrc /file=MNEMONIC.TXT
FIClose
End
```

10.4.10 **"*.LAD" File is Changed to Other PMC Type of "*.LAD" File.**

FIChange [Drive:] [Path] Existing LAD file name [Drive:] [Path] New LAD file name
 [/Pmctype=*string*] [/ioexp=0 | 1] [/symospace1=*character*] [/symospace2=*character*]

Parameter

[Drive:][Path]Existing LAD file name

Specify the file name of existing LAD file.

[Drive:][Path]New LAD file name

Specify the file name of new LAD file.

/Pmctype =*string*

Specify the PMC type name (string) of new LAD file. See Table 10.4.10 (a).

/ioexp =0 : I/O LINK expansion function is disabled.

=1 : I/O LINK expansion function is enabled.

* This parameter is /ioexp=0 when omitted.

/symospace1 = *character*

In the existing LAD file, specify the character of symbol to replace to white-space character.

* If this parameter is omitted, the specified character of symbol is not replaced to white-space character.

/symospace2 = *character*

In a new LAD file, specify the character of symbol to replace to white-space character.

* If this parameter is omitted, the specified character of symbol is not replaced to white-space character. If the white-space character is included in the symbol, change that you do not expect may occur. Usually, do not use this parameter. Recommends not using the white-space character in the symbol.

Explanation

The "FIChange" command changes the existing LAD file to other PMC type of new LAD file.

Note

- "/Pmctype" parameter is not omissible.
- Do not use FIChange command between FIOpen and FIClose.
- A log file (FLNEW.TXT) is created to the same directory path as the LAD file newly created. When a new LAD file cannot be created, the log file is created to same directory path as a command file.

Example

The existing LAD file (SB7-PRG.LAD) is changed to the LAD file (32i.LAD) of other PMC type.

```
FIChange SB7-PRG.LAD D:\PROG\32i.LAD /Pmctype=32i-A
PMC(ext)
End
```

Table 10.4.10(a) PMC model and Setting data

PMC model	Setting data (half-size string)
30i-A PMC	30i-A PMC
30i-A PMC(2nd)	30i-A PMC(2nd)
30i-A PMC(3rd)	30i-A PMC(3rd)
30i-A PMC(DCS)	30i-A PMC(DCS)
30i-A PMC(EXT)	30i-A PMC(EXT)
30i-A PMC(2nd,EXT)	30i-A PMC(2nd,EXT)
30i-A PMC(3rd,EXT)	30i-A PMC(3rd,EXT)
30i-A PMC(DCS,EXT)	30i-A PMC(DCS,EXT)
31i-A PMC	31i-A PMC
31i-A PMC(2nd)	31i-A PMC(2nd)
31i-A PMC(3rd)	31i-A PMC(3rd)
31i-A PMC(DCS)	31i-A PMC(DCS)
31i-A PMC(EXT)	31i-A PMC(EXT)
31i-A PMC(2nd,EXT)	31i-A PMC(2nd,EXT)
31i-A PMC(3rd,EXT)	31i-A PMC(3rd,EXT)
31i-A PMC(DCS,EXT)	31i-A PMC(DCS,EXT)
32i-A PMC	32i-A PMC
32i-A PMC(2nd)	32i-A PMC(2nd)
32i-A PMC(3rd)	32i-A PMC(3rd)
32i-A PMC(DCS)	32i-A PMC(DCS)
32i-A PMC(EXT)	32i-A PMC(EXT)
32i-A PMC(2nd,EXT)	32i-A PMC(2nd,EXT)
32i-A PMC(3rd,EXT)	32i-A PMC(3rd,EXT)
32i-A PMC(DCS,EXT)	32i-A PMC(DCS,EXT)
32i-A PMC/L	32i-A PMC_L
32i-A PMC/L(EXT)	32i-A PMC_L(EXT)
PMC-SA1	PMC-RA1
PMC-SA3	PMC-RA3
PMC-SA5	PMC-RA5
PMC-SB3	PMC-RB3
PMC-SB4	PMC-RB4
PMC-SB4(STEP SEQ)	PMC-RB4(STEP SEQ)
PMC-SB5	PMC-RB5
PMC-SB6	PMC-RB6
PMC-SB6(STEP SEQ)	PMC-RB6(STEP SEQ)
PMC-SB6(IO-2)	PMC-RB6(I_O-2)
PMC-SB6(STEP,I/O-2)	PMC-RB6(STEP,I_O-2)
PMC-SB7	PMC-SB7
PMC-SB7(STEP SEQ)	PMC-SB7(STEP SEQ)
PMC-SC3	PMC-RC3
PMC-SC4	PMC-RC4
PMC-SC4(STEP SEQ)	PMC-RC4(STEP SEQ)
PMC-NB	PMC-NB
PMC-NB2	PMC-NB2
PMC-NB6	PMC-NB6
PMC-PA3	PMC-PA3
PMC-QC	PMC-QC

10.4.11 Terminating Command Processing

End

Parameter

None

Explanation

Terminates command processing.

Note

None

10.5 SAMPLE COMMAND FILE

An example of programming a command file is shown below.

Example)

- <1> Opens ladder program D:\SB6_LAD\SB6_A.LAD.
- <2> Imports source program D:\LAD_SRC\LEVEL1.#LA.
- <3> Imports source program D:\LAD_SRC\LEVEL2.#LA.
- <4> Imports source program D:\LAD_SRC\P15.#LA.
- <5> Imports symbol and comment source program D:\SYMBOL_SRC\XSYMBOL.000.
- <6> Executes compilation in condense mode with the symbol and comment output option specified.
- <7> Exports the ladder program to memory card format file D:\SB6_MEM\SB6_A.MEM.
- <8> Saves the ladder program into D:\SB6_LAD\SB6_A.LAD and closes it.
- <9> Terminates batch processing.

Specify the command procedure for the above processing as follows:

```

;=====
;          FANUC LADDER-III Batch Command File
;=====
FIOpen D:\SB6_LAD\SB6_A.LAD
Import /Ladder= LEVEL1 D:\LAD_SRC
Import /Ladder= LEVEL2 D:\LAD_SRC
Import /Ladder=P15 D:\LAD_SRC
Import /Symbol D:\SYMBOL_SRC
Compile /condense=1 /symbol=1
Export /MemData D:\MEMCARD\SB6_A.MEM
FIClose
End
;

```

10.6 NOTE

If an invalid command or nonexistent file or file folder is specified, processing stops at the point where the invalid item is found.

10.7 EXECUTION LOG FILE

An execution log is recorded in the following format:

command-file-name command-line-number command-name:[/parameter-name]

message-string

Example) test.cmd line 2 DeCompile:[/sysmerge] Command error

command-file-name

Indicates a command file name.

command-line-number

Indicates the number of a line in the command file.

command-name

Indicates the name of a command.

[/parameter-name]

Indicates the name of a parameter.

message-string

Outlines the error or execution status.

Table 10.7

Message	Cause/action
A:E-6007 Command file was not found.	The command file specified by /cmdfile is not found. Confirm the command file pass.
A:E-6008 Command sentence is illegal.	The command name is not correct.
Completed.	The command completed normally.
Command error.	The error occurred in the command execution.
A:E-6009 *.LAD file opening error.	The error occurred in the *.LAD file open.
A:E-6010 LAD file closing error.	The error occurred in the *.LAD file close.
A:E-6011 Parameter is illegal.	The parameter value of the command is not correct. Confirm the parameter value.
A:E-6012 Too many parameters.	Command parameter is excessively specified. Delete any unnecessary parameters.
A:E-6013 Second parameter is different from /Other.	In import and the export command, parameter is different from "/Other" in specified for the second parameter.
A:E-6014 There is no export file.	The export file does not exist in the *.LAD file.
A:E-6015 File name is illegal.	The destination file name is not correct.
A:E-6016 Export folder name is illegal.	The destination folder name is not correct.
A:E-6017 Import file name is illegal.	The source file name is not correct.
A:E-6018 Import folder name is illegal.	The source folder name is not correct.
A:E-6019 [/Other]There is no program.	/Other The specified ladder program has not been opened. Open the specified ladder program.

10.COMMAND LINE EXECUTION FUNCTION

B-66234EN/05

Message	Cause/action
A:E-6020 Memory card format file not found.	The memory card format file does not exist in the *.LAD file. Execute the compilation.
A:E-6021 Password is insufficient	Insufficient password.
A:E-6022 Read only attribute file xxx is already exists.	Since the attribute of xxx file is read-only, the contents cannot be changed.
A:E-6023 Folder xxx is already exists.	Since the attribute of xxx folder is read-only, the contents cannot be changed.
A:E-6024 Cannot open xxx file.	The contents cannot be written in xxx file. Please confirm the attribute of xxx file and the attribute of the folder.
A:E-6026 New lad file name is illegal.	- The LAD file cannot be created, if a file with the same name already exists. - *.LAD is not specified as the extension of a file name. Please check that the extension of the LAD file name is *.LAD.
A:E-6027 Two or more same parameters were specified.	- Two or more "/Pmctype" option or "/ioexp" options were specified. Please confirm the option setup.
A:E-6028 Cannot create new LAD file.	- Cannot create new LAD file. The place that you saved is write-protected.
A:E-6029 Existing Lad file name is illegal.	- There is no specified LAD file.
A:E-6030 It is necessary to decompile LAD File.	- There is an older source program than memory card format file. Please decompile memory card format file and update a source file.
A:W-7004 Duplicate symbol data items defined for the same address were detected. (****items)	**** duplicate symbol data items defined for the same address were detected. Either source data or memory card data is valid according to the setting of the symbol merge option. (Detail log is not output.)
A:W-7004 Duplicate symbol data items defined for the same address were detected. (address ***)	duplicate symbol data items defined for the same address were detected. Either source data or memory card data is valid according to the setting of the symbol merge option. (Detail log is output.)
A:W-7005 Same symbol exists. (**** items)	**** symbols which had been defined were found. The symbol data deletes the symbol in no priority by the option setting about the symbol merging. (Detail log is not output.)
A:W-7005 Same symbol exists. (address **** symbol ****)	The symbol character string defined in the symbol data at address ****/symbol **** is already defined at another address. The symbol data deletes the symbol in no priority by the option setting about the symbol merging. (Detail log is output.)
A:W-7006 The number of symbol data exceeds the limit. *** items were not merged.	During symbol data merge processing, the total number of data exceeded the maximum allowable value defined with the system. Data beyond the symbol data is not output to the source program. (Detail log is not output.)
A:W-7006 The number of symbol data exceeds the limit. *** address were not merged.	During symbol data merge processing, the total number of data items at address ****/symbol **** exceeded the maximum allowable value defined with the system. Data beyond the symbol data is not output to the source program. (Detail log is output.)
"Command File Name" batch command start.	Beginning of command file execution.
Batch command completed.	Batch command completed

11

EXTENDED SYMBOL/COMMENT FUNCTION

The extended symbol/comment function allows you to use the following features.

- Increase in the symbol/comment character count
- Ladder edit by using symbol.
- Symbol effective in each sub-program
- Symbol type setting
- Automatic assignment function for R,D,E address.

How to setup

In case of using the extended Symbol/Comment function, type of PMC program has to be set when creating the new program.

Procedure

1. Select [File(F)] - [New Program]

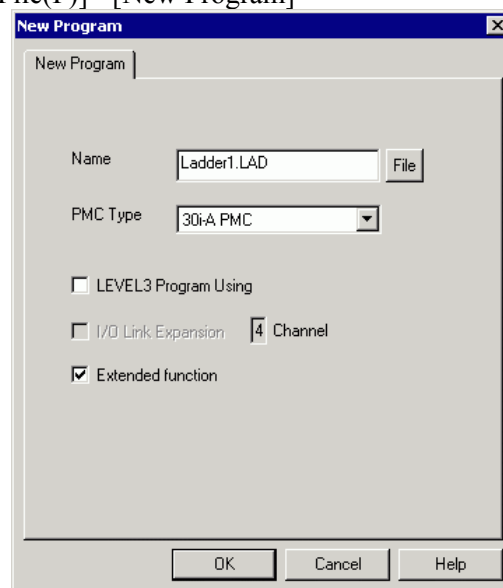

Fig. 11(a)

2. Enter the **Name**, then select the **PMC Type**
3. Check the **Extended Function**
4. Click the **OK** button

5. Display the [Program list] Screen

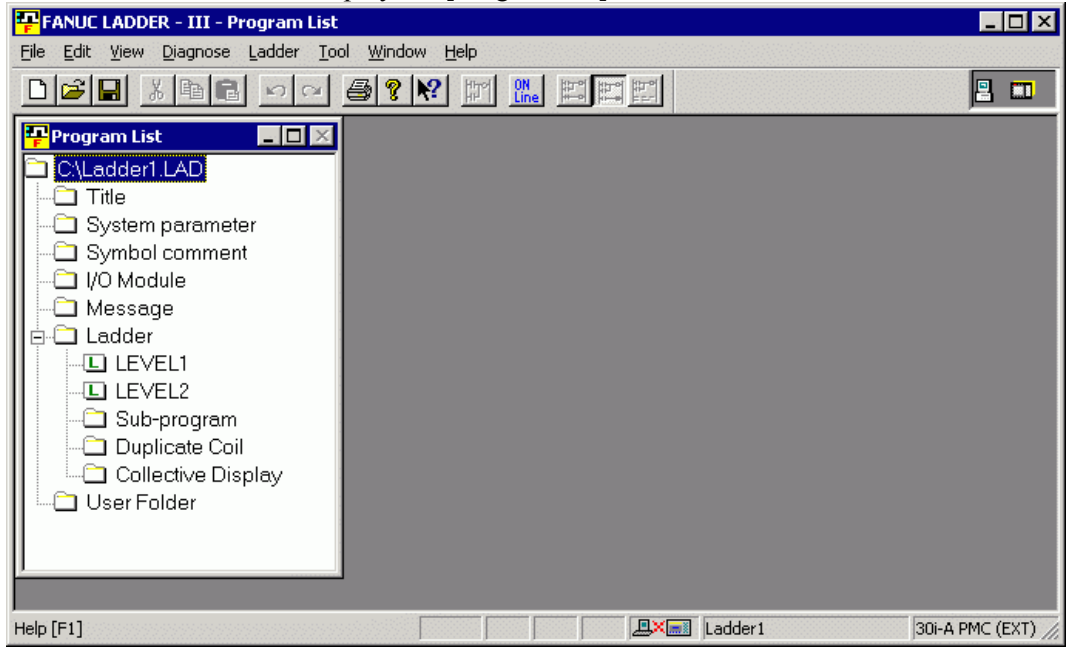

Fig. 11(b)

11.1.1 Relation between the global symbol and the local symbol

The relation between the global symbol and the local symbol is described below.

Table 11.1.1(a)

	Prog. Attribute	Effective range	Comparison	
			Non-Extended function	Extended function
1.	Global	Symbol can be used in all subprograms	Available All symbols are global	Available
2.	Local	Symbol can be used only in one associated subprogram among LEVEL1, LEVEL2, LEVEL3, and P1 to Pn	Not available	Available

As the scope of symbol is limited if the local attribute is specified, same symbol names can be defined and used in different modules without conflicts. The allowed combinations of symbol and associated address are checked as follows.

(a) The symbol is the same and the address is different.

Table 11.1.1(b)

Case	Conditions	Example	Result
a.1	Global symbol is the same and the address is different	ABC R0 ; Global symbol ABC R2 ; Global symbol	(X)
a.2	Global symbol is the same as local symbol and the address is different	ABC R0 ; Global symbol ABC R2 ; Local symbol(P1)	(X)
a.3	Local symbol is the same as other local symbol and the address is different	ABC R0 ; Local symbol(P1) ABC R2 ; Local symbol(P2)	(O)
a.4	Symbol is the same within local symbol and the address is different	ABC R0 ; Local symbol(P1) ABC R2 ; Local symbol(P1)	(X)

(O): The definition is allowed.

(X): The definition is not allowed.

(b) The symbol is different and the address is the same.

Table 11.1.1(c)

Case	Conditions	Example	Result
b.1	Global symbol is different and the address is the same	ABC R2 ; Global symbol ABCD R2 ; Global symbol (Note)	(O)
b.2	Global symbol is different to local symbol and the address is the same	ABC R2 ; Global symbol ABCD R2 ; Local symbol(P1) (Note)	(O)
b.3	Local symbol is different to other local symbol and the address is the same	ABC R2 ; Local symbol(P1) ABCD R2 ; Local symbol(P2)	(O)
b.4	Symbol is different within local symbol and the address is the same	ABC R2 ; Local symbol(P1) ABCD R2 ; Local symbol(P1) (Note)	(O)

NOTE

When you decompile the ladder object, it does not get back to the original symbol.

11. EXTENDED SYMBOL/COMMENT FUNCTION

(c) The symbol is the same and the address is the same.

Table 11.1.1(d)

Case	Conditions	Example		Result
c.1	Global symbol is the same and the address is the same	ABC ABC	R2 ; Global symbol R2 ; Global symbol	(X)
c.2	Global symbol is the same as local symbol and the address is the same	ABC ABC	R2 ; Global symbol R2 ; Local symbol(P1)	(X)
c.3	Local symbol is the same as other local symbol and the address is the same	ABC ABC	R2 ; Local symbol(P1) R2 ; Local symbol(P2)	(O)
c.4	Symbol is the same within local symbol and the address is the same	ABC ABC	R2 ; Local symbol(P1) R2 ; Local symbol(P1)	(X)

(d) The symbol is different and the address is different.

Table 11.1.1(e)

Case	Conditions	Example		Result
d.1	Global symbol is different and the address is different	ABC ABCD	R0 ; Global symbol R2 ; Global symbol	(O)
d.2	Global symbol is different to local symbol and the address is different	ABC ABCD	R0 ; Global symbol R2 ; Local symbol(P1)	(O)
d.3	Local symbol is different to other local symbol and the address is different	ABC ABCD	R0 ; Local symbol(P1) R2 ; Local symbol(P2)	(O)
d.4	Symbol is different within local symbol and the address is different	ABC ABCD	R0 ; Local symbol(P1) R2 ; Local symbol(P1)	(O)

(e) The symbol for L address.

L address can be used at the functional instruction JMPB, JMPC, and LBL. The scope of symbols for L address is checked differently with other symbols as below.

Table 11.1.1(f)

Functional instruction	Note
JMPB	Global symbol and local symbol can be used.
JMPC	Global symbol can be used. Local symbol cannot be used.
LBL	Global symbol and local symbol can be used.

The relation between the global symbol and the local symbol is the same as the above-mentioned description (from a) to d)).

Table 11.1.1(g)

Case	Conditions	Example		Result
e.1	Global symbol is the same	ABC ABC	L1 ; Global symbol L2 ; Global symbol	(X)
e.2	Global symbol is the same as local symbol	ABC ABC	L1 ; Global symbol L2 ; Local symbol(P1)	(X)
e.3	Local symbol is the same as other local symbol	ABC ABC	L1 ; Local symbol(P1) L2 ; Local symbol(P2)	(O)
e.3-1	Local symbol is the same as other local symbol and the address is the same	ABC ABC	L1 ; Local symbol(P1) L1 ; Local symbol(P2)	(O)
e.4	Symbol is the same within local symbol	ABC ABC	L1 ; Local symbol(P1) L2 ; Local symbol(P1)	(X)
e.5	Global symbol is different and address is the same.	ABC ABCD	L1 ; Global symbol L1 ; Global symbol	(O)
e.6	Global symbol is different to local symbol and address is the same.	ABC ABCD	L1 ; Global symbol L1 ; Local symbol(P1)	(O)

Case	Conditions	Example	Result
e.7	Local symbol is different to other local symbol and address is the same.	ABC L1 ; Local symbol(P1) ABCD L1 ; Local symbol(P2)	(O)
e.8	Symbol is different within local symbol and address is the same.	ABC L1 ; Local symbol(P1) ABCD L1 ; Local symbol(P1)	(O)

- (f) The symbol for P address.
 P address can only be used as global and cannot be used as local address. The scope of symbols for P address is checked differently with other symbols as below.

Table 11.1.1(h)

Case	Conditions	Example	Result
f.1	Global symbol is the same	ABC P1 ; Global symbol ABC P2 ; Global symbol	(X)
f.2	Global symbol is different and address is the same.	ABC P1 ; Global symbol ABCD P1 ; Global symbol	(O)
f.3	Global symbol is different and address is different.	ABC P1 ; Global symbol ABCD P2 ; Global symbol	(O)

NOTE

- 1 When you decompile the ladder object code containing the references to the symbols with the same address, such references may not get back to the symbol in the original source program. The symbol name may be changed to one of the symbols selected by decompiler.
- 2 When multiple symbols are defined for the same address, only one symbol selected by the system is displayed in the address display of the signal status screen etc. on PMC. Other symbols are not displayed.

11.1.2 About the Symbol Type

Type can be set to the symbol.

BOOL:

Set to the symbol which is used as basic instructions.

BYTE, WORD, DWORD:

Set to the symbol which is used as parameters for function instructions.

11.1.3 About the Distinction of Symbol and Address

In case that a symbol R10 is defined, "R10" is interpreted as R10 of symbol. If you want to enter address R10 explicitly, "%R10" is to be input. "% + address" should be used when you want to input it specifically in the address. Without the definition of the symbol R10, you do not need to input with %. In case of the mnemonic file of extended function, it is always necessary to add % to the address

11.2 EDITING SYMBOL AND COMMENT

- It is possible to display and edit Symbol and comment.
- It is possible to display the list of the registered symbol.
- It is possible to add, delete, change and search symbol.
- It is possible to create NULL symbol (only comment is defined to address without symbol)

Procedure

1. Double-click the <Symbol comment> item on the [Program List] screen.

The [SYMBOL/COMMENT] screen appears.

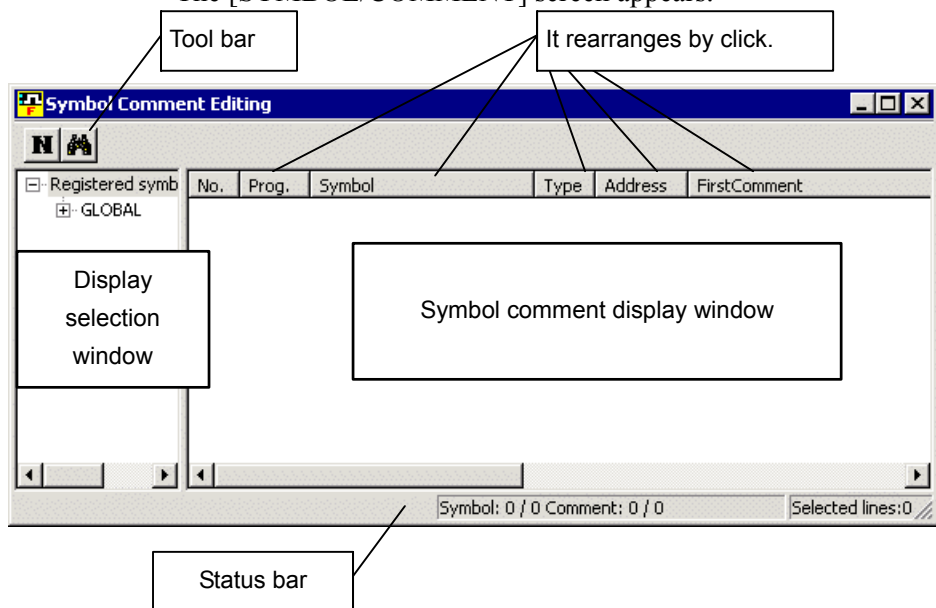

Fig. 11.2

11.2.1 Toolbar



(1) (2)

- (1) <Add New Data> button
The [New Data] screen appears.
- (2) <Search> button
The [Search] screen appears.

11.2.2 Context Menu

Right-click the [Display selection window] screen. The following context menu appears.

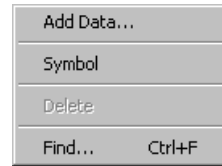

Fig. 11.2.2(a)

Add Data...	Display [Add Data] screen
Symbol	Display the symbol which is set in P address of sub program
Delete	Delete all symbols of [Symbol/comment display window]
Find...	Find [Symbol/comment display window]

Right-click the [Symbol comment display window]. The following context menu appears.

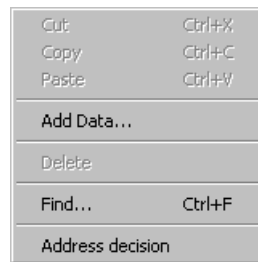

Fig. 11.2.2(a)

Cut	Move selected data to the clipboard
Copy	Copy selected data to the clipboard
Paste	Copy from the clipboard additionally
Add Data...	Display [Add Data] screen
Delete	Delete all symbols of [Symbol/comment display window]
Find...	Find [Symbol/comment display window]
Address decision	Decide the address that is automatically assigned. Decide the assigned address to delete the * mark which places in the top of the address.

11.2.3 Add New Symbol and Comment

Procedure

1. Click <Add New Data> button on toolbar.

Fig. 11.2.3

2. Set the data

- **PROG.** Global symbol and local symbol are specified
Global symbol : Nothing is input
Local symbol : LEVEL1, LEVEL2, %P1 etc is input
- **SYMBOL** Input symbol
- **ADDRESS** Input address
- **TYPE** Input. symbol type
Basic instruction : Select BOOL
Functional instruction : Select BYTE, WORD, DWORD
Subprogram(P address) : Select PROG
Label(L address) : Select LABEL
- **1st Comment** Input comment
- **2nd Comment**
- **3rd Comment**
- **4th Comment**

It is necessary to input Symbol and type to register the symbol.

3. Click <Add> button to register the input data.
Click <Close> or <Cancel> button to cancel registration.

⚠ CAUTION

- 1 Same symbol data can not be registered. As error message is displayed when adding new data, register another symbol, please.
- 2 More than one symbol can be set for one address. In this case, the original symbol data may not be restored by decompilation. It is confirmed to check [Multiple use check of the symbol address] of compile option.
- 3 Symbol set to P address always becomes a global symbol.

11.2.4 Modifying Symbol and Comment Data

Procedure

1. Double-click the symbol that you want to modify. (Or position the cursor to the symbol and press [Enter] key.) Following dialog will appear.

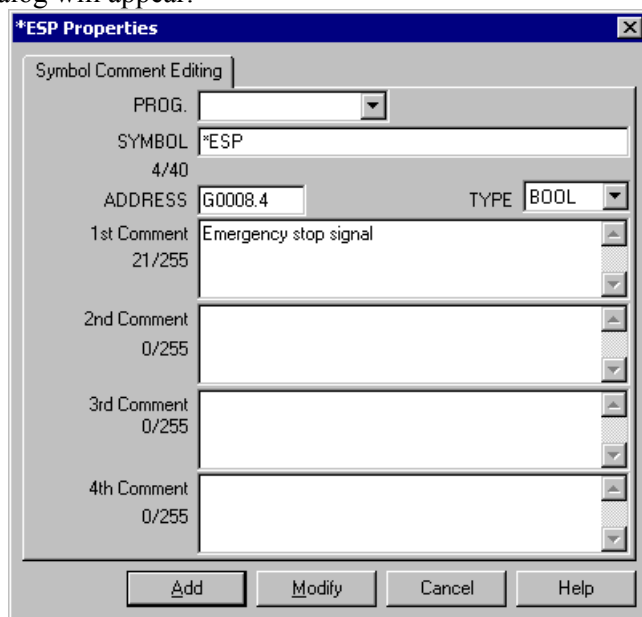
**Fig. 11.2.4**

2. Modifying the symbol or comment.
 - <Add> Add the symbol and comment. Click to add a registered symbol as another new symbol.
 - <Modify> Modify the symbol and comment. Click to change the symbol and comment.
 - <Cancel> Click to stop registration of the symbol.

11.2.5 Cut, Copy and Paste of Symbol or Comment Data

Plural symbol and comment data can be selected and cut, copy and paste operation is available to them.

Procedure

1. Select the symbol to modify or copy.
To select plural symbol and comment data, click the symbol/Comment data with pressing [Ctrl] key.
2. Click the [Cut] or [Copy] of context menu which is displayed by right-clicking the symbol and comment data selected above.
These cut or copied data are able to paste to test editor.
3. To add new symbols from cut or copied data, click the [Paste] of context menu which is displayed by right-clicking the symbol and comment data.
4. When the pasted symbol is already registered (Duplicate symbol has been detected), [Overlap with registered symbol] dialog will appear. Please modify symbol data and click <OK> button.

11.2.6 Deleting Symbol and Comment Data

Deleting symbol and comment data.

Procedure

1. Select the symbol to delete.
2. Click the [Delete] of context menu that is displayed by right-clicking the symbol selected above.
3. Confirm message will appear. Click the <OK> button to delete.

11.2.7 Search

Search the symbol and comment data by No., symbol, address and comment. It is ignored whether the strings are specified in upper case or lower case.

Symbol	Search same symbol
Address	Search same address
Comment	Search the comment which include the specified strings.

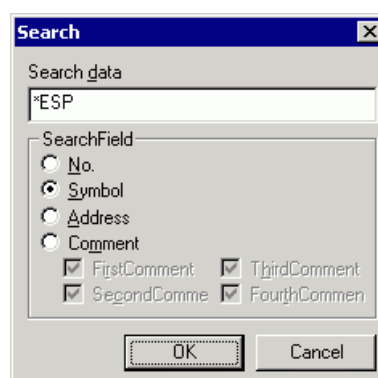

Fig. 11.2.7

Procedure

1. Input character string to search into [Search data].
2. Select the item to search by [SearchField]
3. Click <OK> button to start search.

NOTE

- 1 Even if the symbol data is modified or deleted in symbol/comment editing screen, the modification of symbol does not influence to the ladder program. Therefore, the symbol in ladder program must be modified too.
- 2 Modifying the address of symbol in symbol/comment editing screen does influence to the ladder program. Address of the symbol in ladder program is changed. When the data is made by inputting address in ladder editing screen and then the symbol is defined in symbol/comment editing screen, address of the symbol is not changed by above operation. This note is not applicable to the data which was once de-compiled.
- 3 Please avoid using the symbol that has same notation of PMC address.
- 4 The search by address in ladder program is unavailable when the symbol is modified or deleted in symbol/comment editing screen.

11.3 EDITING LADDER DIAGRAMS

NOTE

- 1 For editing the extended ladder program, ladder editor does not support the interface of two pains; “Display Window” and “Edit Window”.
- 2 Extended ladder program does not support Step Sequence.

11.3.1 How to View whole Program

Operation

1. Double-click [Ladder] node in [Program List] screen to open [Ladder] window.
2. Whole ladder program appears in window. It is shown as View mode; you can not edit it in this window.

11.3.2 How to Display and Modify Ladder Program

Double-click a sub-program in [Program List] screen to open its ladder diagram.

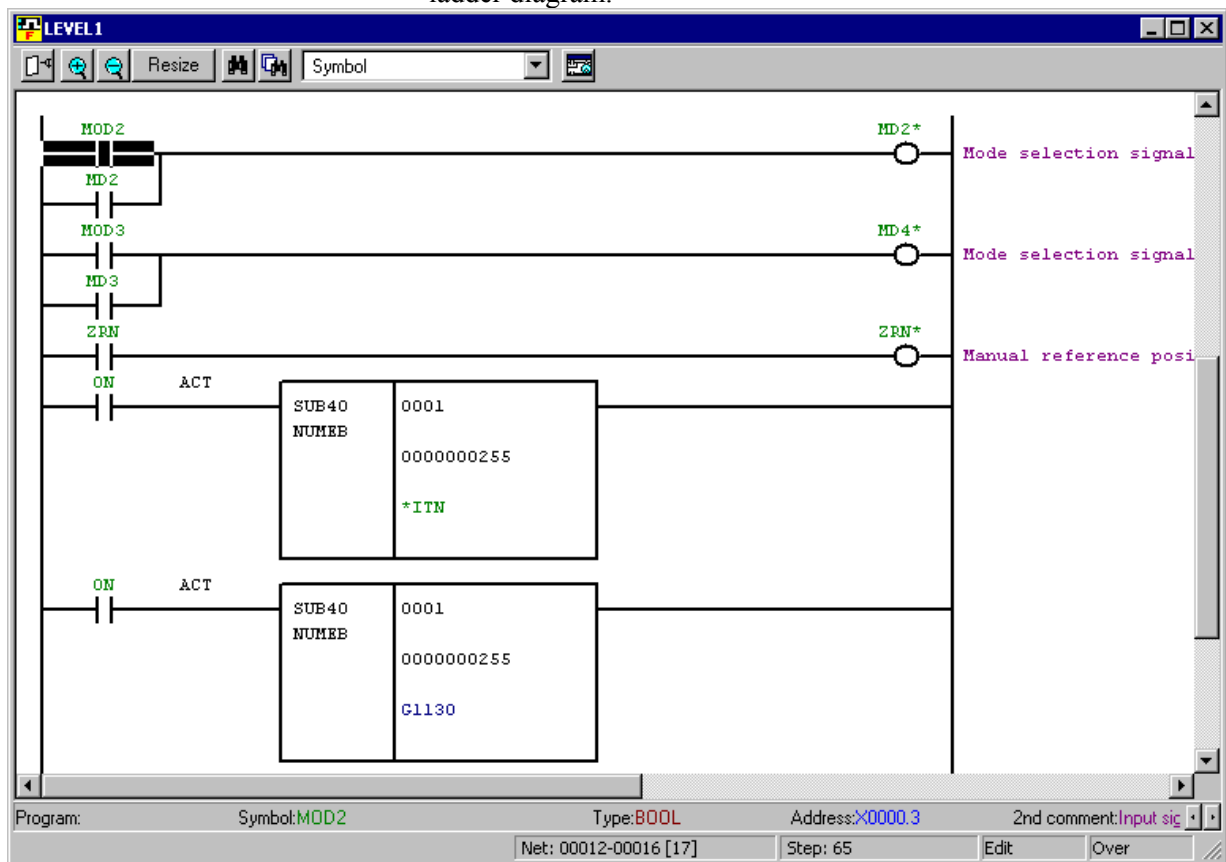

Fig. 11.3.2

Table 11.3.2

Address display format	Information to be displayed
Address	Upper: Address is displayed. In cases below, its symbol appears instead: <ul style="list-style-type: none"> • Symbol is defined, but its address is not assigned yet. • Corresponding symbol is not defined (undefined symbol)
Symbol	Upper: Symbol is displayed. In cases below, its address appears instead: <ul style="list-style-type: none"> • No symbol is defined for the address. • Case of NULL symbol.
Comment	Upper: Comment is displayed. In cases below, its address appears instead: <ul style="list-style-type: none"> • No symbol is defined for the address. • The symbol of the address has no comment. In cases below, its symbol appears instead: <ul style="list-style-type: none"> • Symbol is defined, but its address is not assigned yet. • Corresponding symbol is not defined (undefined symbol)
Address & Symbol	Upper: Address is displayed. Lower: Symbol is displayed.
Address & Comment	Upper: Address is displayed. Lower: Comment is displayed.
Symbol & Comment	Upper: Symbol is displayed. Lower: Comment is displayed.

Upper: 8 characters at maximum

Lower: 16 characters at maximum

You can customize the color of Symbol, Address, and Comment at [Ladder] tab of [Option] window.

11.3.3 How to Create Ladder Program

Enter an address or a symbol that is already defined.

If an undefined symbol is entered, [New Registration] screen of symbol appears; the symbol will be defined and entered at once.

[Property] screen shows the detail of an address or a symbol in ladder diagrams.

You can modify the comment and so on.

Procedure

1. Move cursor onto the symbol or address whose information you want to change.
2. Click [Property] in the context menu, which pops up at right-click.
3. [Property] screen appears.

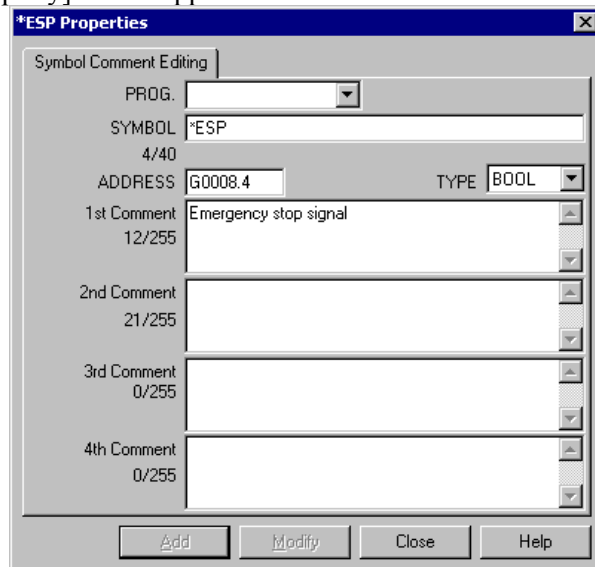

Fig. 11.3.3

NOTE

- 1 When the symbol is used in multiple parts of ladder, please do not change the symbol name by pushing <Modify> button. In this case, please add the symbol by pushing <Add> button. Otherwise, you may see unexpected side effect of the change, such as undefined symbol.
- 2 If you want to change the symbol of the ladder program, please use Search/Replace function.

11.3.4 Tool Tip

When you move cursor onto a basic instruction or a parameter of a functional instruction, related symbol, address, and comment are displayed.

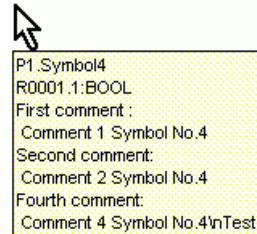

Fig. 11.3.4

Operation

1. Click [Option] in [Tool] menu.
2. Click [Ladder] tab in [Option] window.
3. Check [Tool tip].

In cases below, tool tip will not appear:

- Symbol is not defined (undefined symbol)
- Symbol is defined, but its address is not assigned yet.

11.3.5 Comment of Contact and Coil

You can select the comments to be displayed with associated contacts and coils.

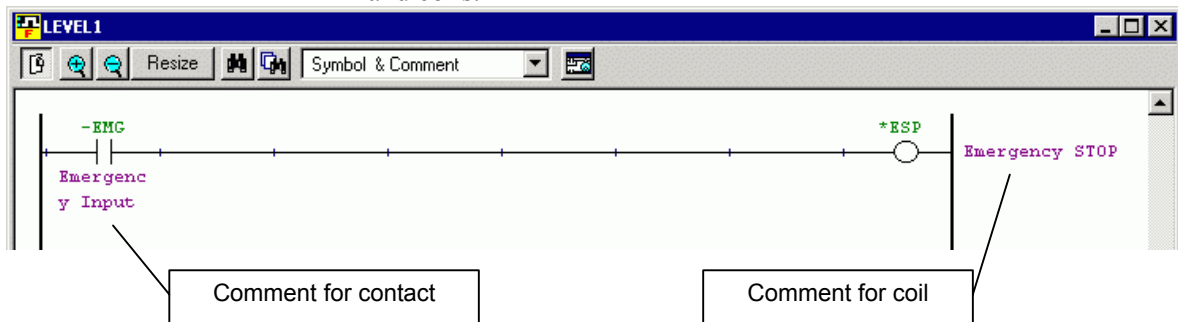

Fig. 11.3.5

Operation

1. Click [Option] in [Tool] menu.
2. Click [Ladder] tab in [Option] window.
3. Choose comment in the list-boxes [Show comment of Contact] and [Show comment of Coil].

11.3.6 How to Change Symbol or Address

You can choose one of following ways to change address or symbol in ladder diagram:

Search the address, and change them one by one.	Search function
Collect the appearance of the address, and change them one by one.	Search function Collective display function
Use Replace function to change them at once.	Replace function

11.3.6.1 Search function

You can find a symbol, address, or functional instruction in the ladder diagram.

Operation

1. Open the ladder program in which you want to find something.
2. Click [Find...] in [Edit] menu, or press <Ctrl>+<F>.
3. [Search] screen appears.

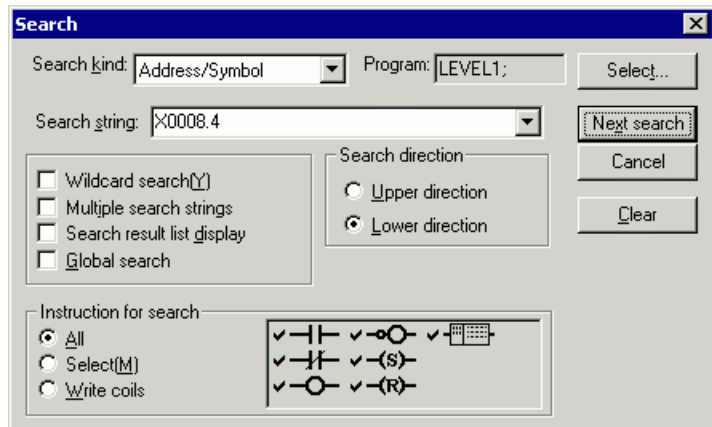

Fig. 11.3.6.1

4. Enter the address or symbol that you want to find.
5. Click [Next search] button to search it.

Table 11.3.6.1

Search kind	Select one of Address/Symbol and Functional Instruction.
Program	Choose the programs to be searched
Search string	Enter the string to search for.
Wildcard search(Y)	This option is available to search for an address. With this option, you can use wildcard characters '*' and '?' in the search string. Search string of "R10.*" will hit any of R10.0 - R10.7. You can not use wildcard search at searching for a symbol.
Multiple search strings	You can specify multiple addresses separated by comma "," or semicolon ";", such as "Y0.0;X0.0".
Search result list display	The result of the search summarizes the results in [Search result list] screen. [Search result list] screen shows the program number, net number, ladder diagram, and coil comment of each appearance of what you searched.
Global search	Search the whole ladder program.

NOTE

- 1 The wildcard letter can match with any single or multiple letters.
- 2 Question mark “?” matches with any single letter. More than one “?” can be placed for any letters to match with.
- 3 Asterisk mark “*” matches with 0 or more any letters.

Search by function key**Operation**

1. Move cursor onto the address or symbol that you want to search for.
2. Press <F3> key to search for it at contacts, coils, and parameters of functional instructions.
Press <F2> key to search for it at coils only.

Search by context menu**Operation**

1. Move cursor onto the address or symbol that you want to search for.
2. Right-click to pop up the context menu, and choose [Find...] in it.

11.3.6.2 Collective Display function

The result of search function can be listed in Collective Display. The condition of search can be saved. One or more conditions can be managed by following operations:

- Setting condition for Collective Display
- Perform Collective Display function

(1) Setting condition for Collective Display

Operation

1. Double-click [Collective Display] in [Program List] screen to open Collective Display screen.

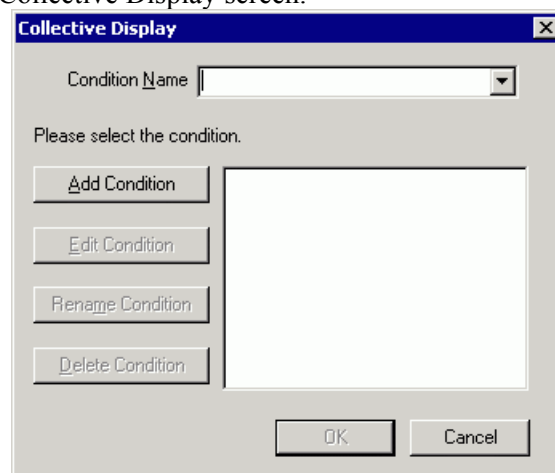

Fig. 11.3.6.2(a)

2. Click [Add Condition] button to reach Search screen.

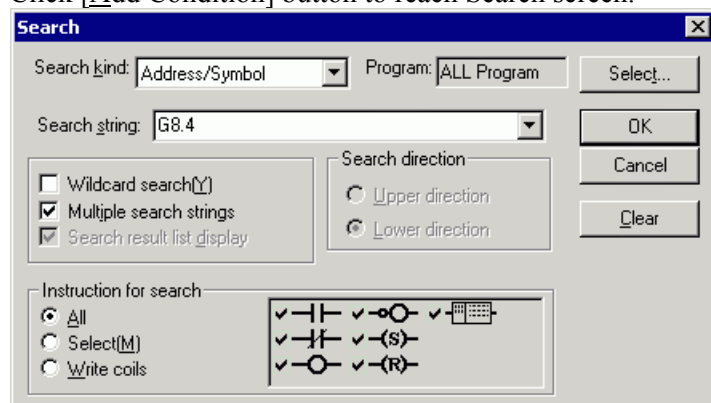

Fig. 11.3.6.2(b)

3. Set the condition of search, and then click [OK] button. [Setting of search condition-name] screen appears.

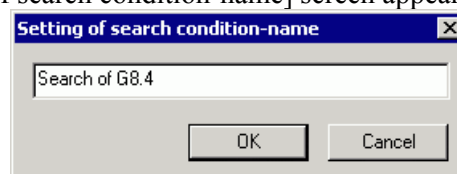

Fig. 11.3.6.2(c)

- This string will be the name of the search condition and will be listed in [Collective Display] screen.
4. The list in [Collective Display] is updated to contain the new condition.
 5. Repeat 2-4 if necessary.
 6. Check the conditions that you want to enable, and name the search condition at [Condition Name].

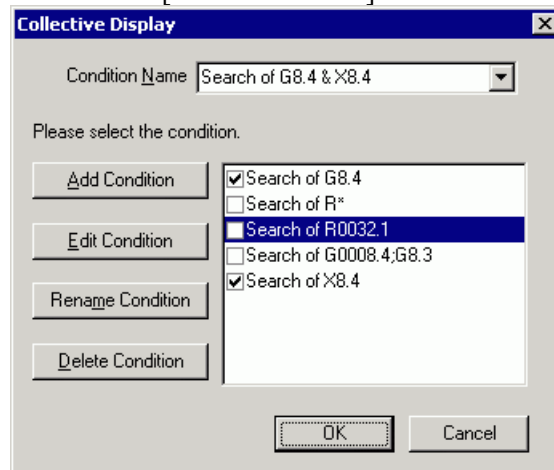

Fig. 11.3.6.2(d)

Click [OK] button.

The nets that meet the search condition are collected and displayed at a time.

You can use this function in on-line mode also.

(2) Perform Collective Display function

Operation

1. Right-click the search condition to be modified in [Program List] screen.

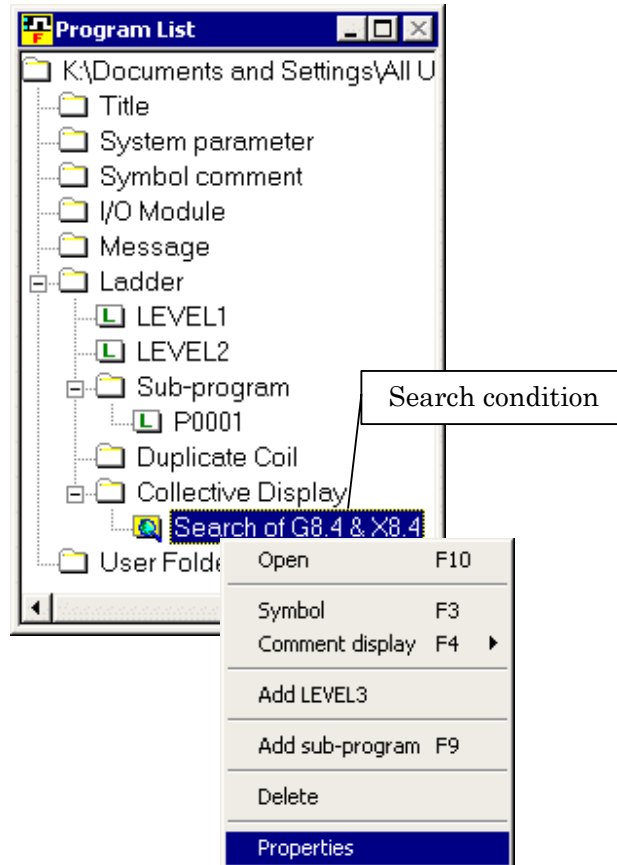

Fig. 11.3.6.2(e)

2. Select [Property] to see [Collective Display] screen. Confirm the condition, and close the [Collective Display] window.
3. Double-click the search condition node to display the result of the search.

11.3.6.3 Replace function

Procedure

1. Select [Replace...] in [Edit] menu. [Replace] screen appears.

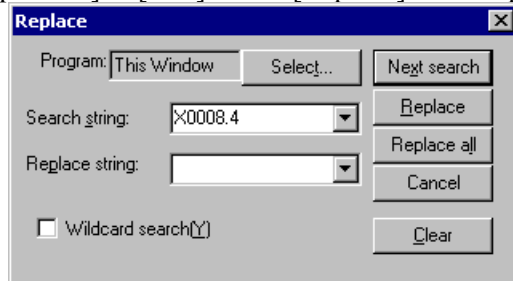

Fig. 11.3.6.3

Table 11.3.6.3

Program	Specify the program in which the address will be replaced.
Search string	Enter the string to search for; address or symbol. You can use wildcard characters '*' and '?' in the search string only at searching an address.
Replace string	Enter the string to be replaced with. You can use wildcard characters '*' and '?' in the replace string only at searching an address.
Wildcard search(Y)	This option is available to replace an address. With this option, you can use wildcard characters '*' and '?' in the search string. Search string of "R10.*" will hit any of R10.0 - R10.7 You can not use wildcard search at replacing symbols.

2. Perform Replace function.

- [Next search] Searches for the next appearance of the search string.
- [Replace] Replaces the search string with the replace string.
- [Replace all] Replaces all appearances of the search string with the replace string.
- [Cancel] Cancels the replace operation and close this dialog-box.
- [Clear] Initializes all parameters.

NOTE

- 1 [Replace...] in [Edit] menu can be activated when ladder editing function is available.
- 2 If an undefined symbol is inputted as the replacement string, "Replace" can not be performed. You have to register the symbol before performing the replacement.
- 3 The wildcard letters can not be used at replacing symbol.
- 4 The wildcard letter can match with any single or multiple letters.
- 5 Question mark "?" matches with any single letter. More than one "?" can be placed for any letters to match with.
- 6 Asterisk mark "*" matches with 0 or more any letters.
- 7 Wildcard letters can not be used in a signal name.

Wildcard

(1) Asterisk "*"

The wildcard asterisk can be used as below:

	Replace with					
Search for	Y200	Y*	Y200.1	Y*.1	Y200.*	Symbol
X100	OK	NG	NG	NG	NG	OK
X*	OK	NG	NG	NG	NG	NG
X100.0	NG	NG	OK	NG	NG	OK
X*.0	NG	NG	OK	OK(*)	OK	NG
X100.*	NG	NG	OK	OK	OK	NG
Symbol	OK	NG	OK	NG	NG	OK

OK : Effective

NG : Ineffective

OK(*) : Effective if their address types are the same, such as replace "X*.0" with "X*.1".

Following usages of wildcard letters are forbidden:

X1*	X1*1	X*1	X*1*
X1*.0	X1*1.0	X*1.0	X*1*.0
X1*.*	X1*1.*	X*1.*	X*1*.*
X*.*	*.*		

(2) Question mark "?"

The wildcard question mark can be used as below:

effective		forbidden	
X0??0	→ Y0??0	X0??0	→ Y0?00
		X0??0	→ Y0?0?
		X0??0	→ Y0???0
		X0??0	→ Y0??0.0
X0??0.0	→ Y0??0.0	X0??0.0	→ Y0??0.?0
		X0??0.0	→ Y0??0.

11.3.7 How to Add Sub-program

Add the sub-program.

Procedure

1. Right-click the mouse in [Program List] screen, and then click [Add sub-program F9].

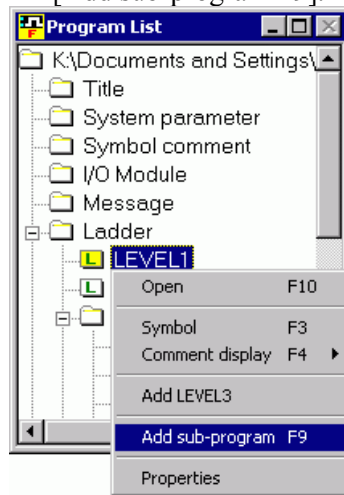

Fig. 11.3.7(a)

2. The [Add sub-program] screen appears.

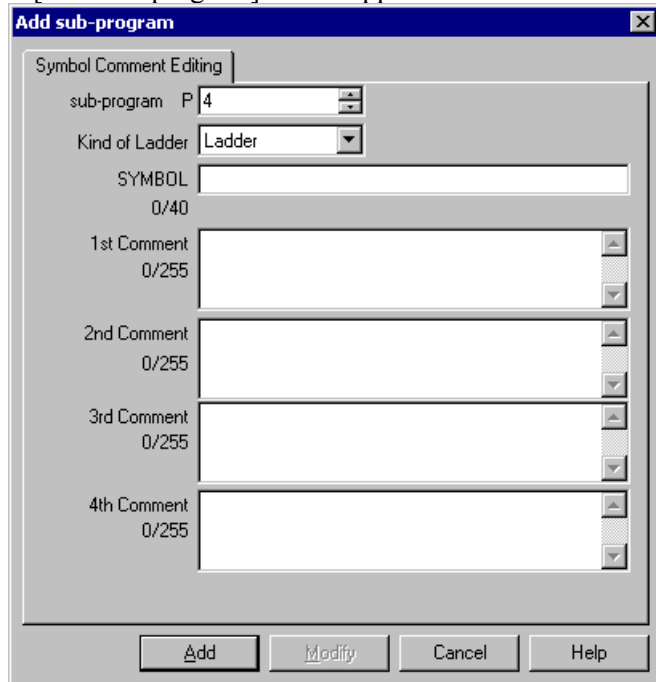

Fig. 11.3.7(b)

3. Set the data
 - Input program number.
 - Input Ladder
 - Input symbol
 - Input comment
 -
 -
 -
4. Click the <Add> button and add the sub-program.

11.3.8 Notes at Editing Ladder Program

1. Do not create a symbol that can be read as an address.
If you make a symbol such as "X003", the search/replace function may not be able to work properly with "X003".
2. If two or more symbols are assigned to the same address, the symbol to be displayed for the address is determined in priority as follows:

Program	Symbol	Type	Address	Priority	
				P1	Other
	ABC	BYTE	R10	4	2
	ZAB	DWORD	R10	3	1
P1	A_1_P1	WORD	R10	1	-
P1	A_2_P1	WORD	R10	2	-

In case of different symbols with same address:

- (1) Symbol with same program with current program of screen.
Local symbol is preferred to global one.
 - (2) Symbol of larger data type.
Symbol of DWORD, symbol of WORD and then symbol of BYTE.
 - (3) Alphabetical order of symbol name.
Order in ASCII code ignoring their cases.
3. If two or more symbols are assigned to the same address, the symbols in ladder program may change at de-compilation. Do not assign two or more symbols to an address.

Program	Symbol	Type	Address
	ABC	BYTE	R10
	ZAB	DWORD	R10

In case of symbol definitions above, the symbol "ABC" used in the original ladder program will change into "ZAB" at the de-compilation.

You can check the duplicated address assignment of symbols at compilation of the ladder program.

Operation

1. Click [Option...] in [Tool] menu.
2. Click [Compile] tab in [Option] window.
3. Click to check **Multiple use check of the symbol address**.

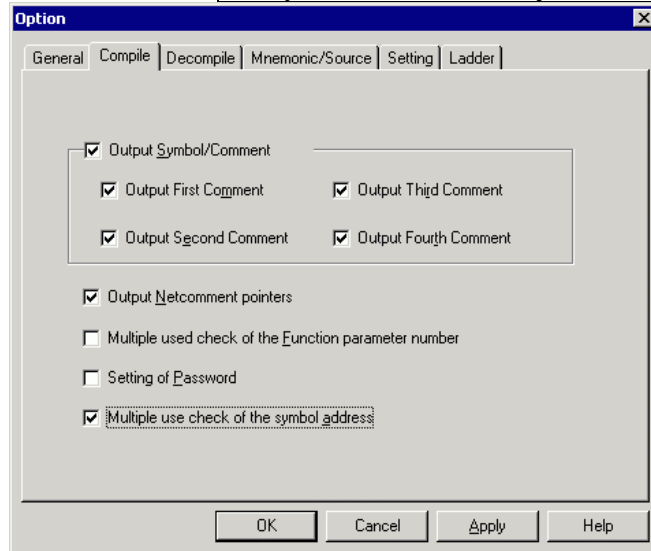

Fig. 11.3.8(a)

11.3.9 Input of Jump Label by Symbolic Name

This function enables the following programming.

- You can input directly a symbol as the label of JMPB/ JMPC/ LBL instructions without assignment of specific label number.
- If you input the undefined symbol as the label on the offline editing screen, the new symbol data definition screen is opened automatically and the program name, L address and LABEL type are input automatically.
- When you compile the ladder program, appropriate L address is assigned automatically if setting of specific L address is not done for the symbol.

Ladder Edit

1. Input the label of the JMPB/JMPC/LBL instructions.

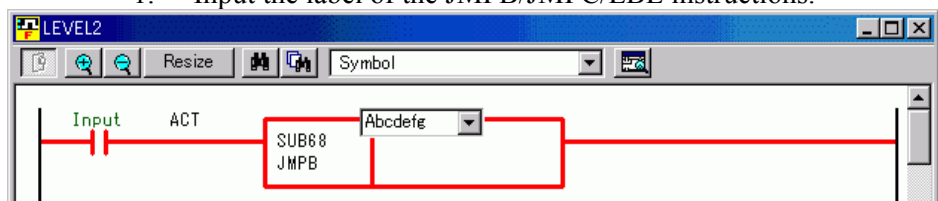

Fig. 11.3.9(a)

11. EXTENDED SYMBOL/COMMENT FUNCTION

2. If you input the label as the undefined symbol, the following new data definition screen appears. If you input the defined symbol, the new data definition screen does not appear.

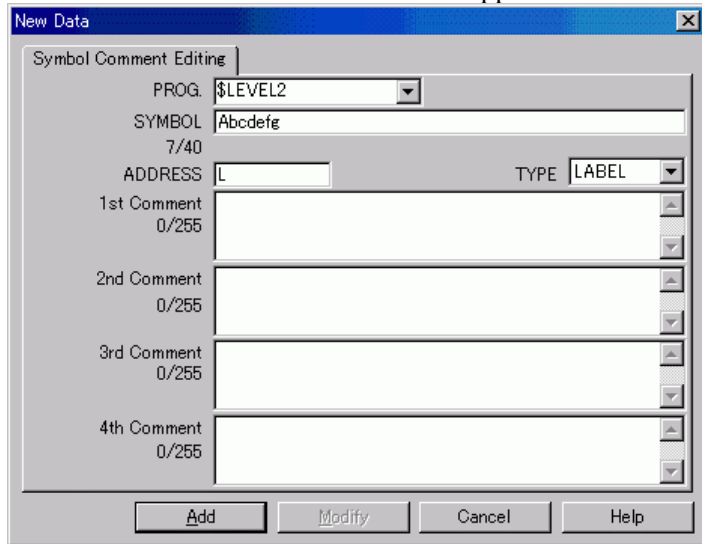

Fig. 11.3.9(b)

The following items are input automatically.

Table 7.1(a)

Item	Contents
PROG.	The contents of PROG are decided as follows by the functional instruction and the subprogram name. - JMPB: Since each program name is input, it is defined as the local symbol. - JMPC: Since nothing is input, it is defined as the global symbol. - LBL: In LEVEL2, it is defined as the global symbol. Except LEVEL2, it is registered as the local symbol.
SYMBOL	It is the label name input in the JMPB/ JMPC/ LBL instructions
ADDRESS	Only "L" is input automatically. If you want to assign any specific label number, you may change it.
TYPE	"LABEL" is input automatically.

Source conversion

In the processing that converts the mnemonic into the source file, if the following conditions are fulfilled, the symbol will be defined automatically.

- The undefined symbol is inputted as the label of the JMPB/JMPC/LBL instruction.
- The identification code of the mnemonic is "%@3-D".

%@3-D		
RD	Input	
JMPB	abc	
abc	LBL	
zyx	LBL	
. . .		
%P1	SP	
	RD	Input
	JMPC	zyx
. . .		
%		

If the symbol "abc" is not defined, it is defined automatically into the symbol comment data.

Fig. 11.3.9(c) Mnemonic

Compile

L address of the symbol is assigned.

Operation

1. Select [Tool]-[Compile...]. Then, the [Compile] dialog appears.
2. Click the <Exec> button.
3. The L address is assigned.

NOTE

- 1 You can define the new label on the offline editing screen.
- 2 You cannot define the new label on the online editing screen. But, you can use the already defined symbol.
- 3 You can input the symbol of only LABEL type as the label of the JMPB/JMPC/LBL instructions.
- 4 If assigned L address is displayed on the symbol comment edit display, the "*" mark adheres to the head of the address.
- 5 When the automatic assignment area becomes empty, the error occurs, and compile processing is stopped.
- 6 L address is assigned without regard to the setting of "Automatic Assignment Address" on the system parameter screen.

Mnemonic Conversion

Source data are converted into the mnemonic format file.

- Identification code of the symbol: "%@2-D"
The output format of L address is as follows by "Selection Item" on the Mnemonic Conversion screen.

Table 11.3.9(b) Output format of the symbol

Selection Item	The symbol format		
	Source data	Mnemonic	
Extended function	ABC *L2	Mnemonic Conversion	ABC L:LABEL
	ABC L		ABC L:LABEL
	ABC L3		ABC L3:LABEL
P-G Compatible Full Options Label/Subprogram	ABC *L2	Mnemonic Conversion	ABC L2:LABEL
	ABC L		"K: E-6101: The address of symbol is undefined.(ABC)" occurs.
	ABC L3		ABC L3:LABEL

Print

Not to print the label type symbol, the setting of "LABEL types are not printed." was added to the "Symbol Comment" tab of the printing option screen.

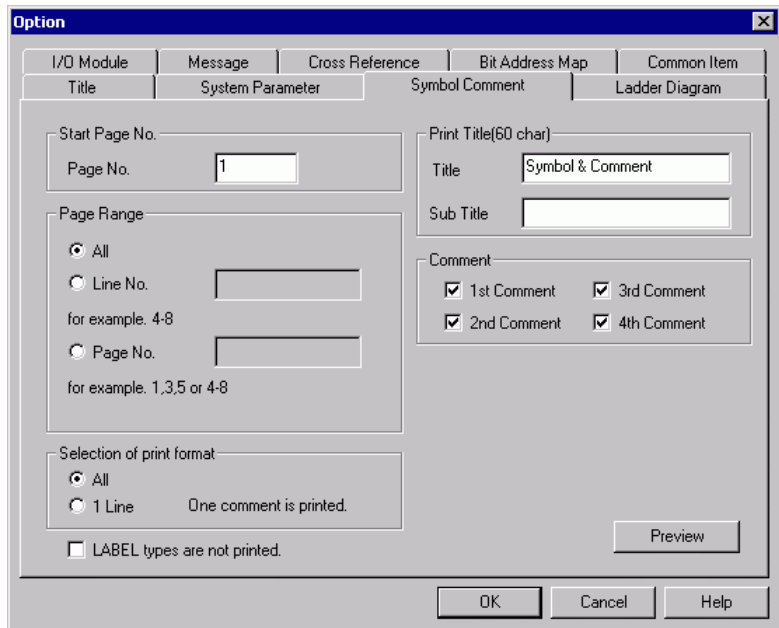

Fig. 11.3.9(d)

If you check "LABEL types are not printed.", the LABEL type symbols will not print. (The default setting is no check)

- Symbol
L address assigned automatically is printed with the "*" mark at the head of the address.

[main_v6]		Symbol & Comment	
NO.	PROG. SYMBOL (1) FIRST COMMENT (2) SECOND COMMENT (3) THIRD COMMENT (4) FOURTH COMMENT	TYPE	ADDRESS
00001	g_Label_1	LABEL	*L0001
00002	LEVEL1 Label_1	LABEL	*L0002
00003	LEVEL1 Label_2	LABEL	*L0003
00004	LEVEL2 LACT	BOOL	R0120.0
00005	LEVEL2 LACTFN	BOOL	*R0110.0
00006	LEVEL2 ACTION	BOOL	*R0110.1
00007	P11 Label_1	LABEL	*L0002
00008	P11 Label_2	LABEL	L0004

Fig. 11.3.9(e)

11.4 AUTOMATIC ADDRESS ASSIGNMENT FUNCTION

When a fixed address need not be assigned for relay contact used temporarily in program etc., the address can be assigned automatically at compiling by inputting only data type and address type when symbol is defined.

Automatic assignment is applied to the following symbols.

- Symbol of BOOL, BYTE, WORD and DWORD type
- Address of R, D, E

11.4.1 Set Screen

Specify the address area used for an automatic assignment.
The range of address is specification of each type.

Procedure

1. Double-click the <System parameter> item in the [Program List] screen. The [Edit System Parameter] screen appears.
2. Check the Automatic Assignment of Address and click the [Details].

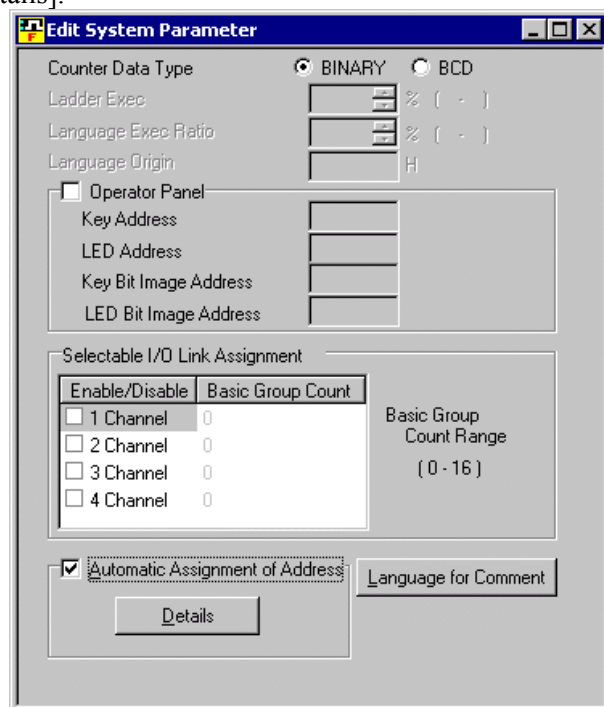

Fig. 11.4.1(a)

3. Enter the range in an assigned address.

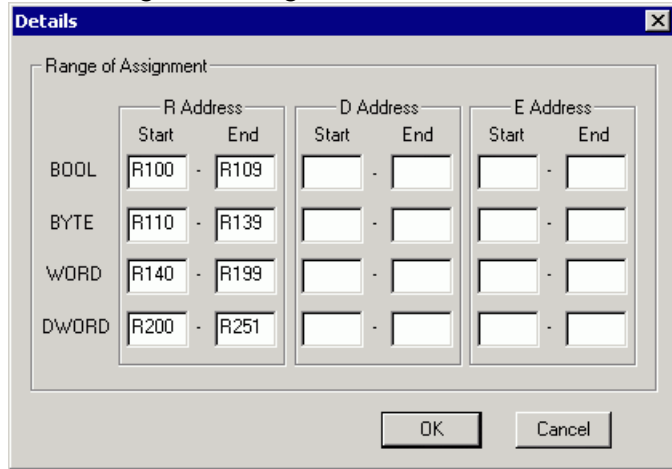

Fig. 11.4.1(b)

	Type	Rang of Assignment	
R address	BOOL	R100.0 -	R109.7
	BYTE	R110 -	R139
	WORD	R140 -	R199
	DWORD	R200 -	R251

WARNING
 Set the address ranges not to overlap. Otherwise, an error occurs when compiling.

11.4.2 Set of Symbol

The symbol of automatic address assignment is set on the symbol edit display.

Procedure

1. Double-click the <Symbol comment> item in the [Program List] screen. The [Symbol Comment Editing] screen appears.
2. Double-click a symbol to open the property screen.
3. Enter “R” to ADDRESS.

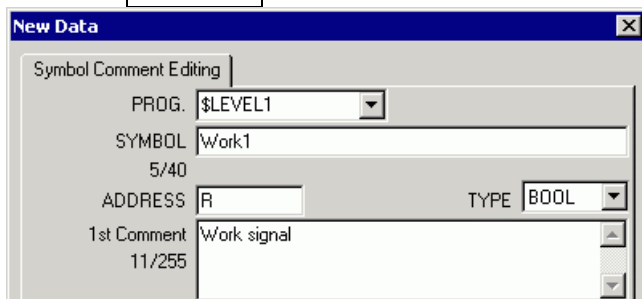

Fig. 11.4.2(a)

Enter “D” for D address.
 Enter “E” for E address.

4. When compiling, the address is assigned.

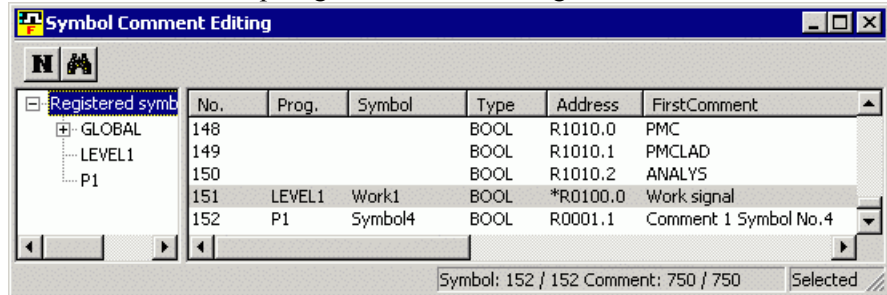

Fig. 11.4.2(b)

The * mark adheres to a head of address.

11.4.3 Address Decision

The address with * mark which assigned automatically is assigned at each compilation. If an address is not changed, the address is decided.

Procedure

1. Double-click the <Symbol comment> item in the [Program List] screen. The [Symbol Comment Editing] screen appears.
2. Click the Address decision of context menu that is displayed by right-clicking the assigned address.

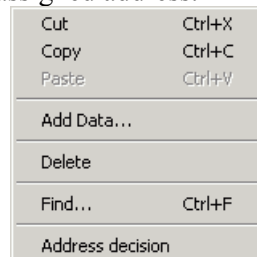

Fig. 11.4.3

The * mark of the address disappears.

NOTE

1. When setting the range of address by an automatic assignment on the System Parameter screen, please set the range of unused address in a ladder.
2. The address is assigned according to the symbol type. Therefore, please don't use this function for the symbol of a functional instruction with the data length which is not consistent with the type of symbol.

11.5 CONVERTING TO SOURCE PROGRAMS

- When the mnemonic file of non-extended functions is converted into the source of extended functions, the unusable character in the symbol is replaced as follows.

- Replacement of the symbol character (Identification code: %@2-C, %@2-C2)

Table 11.5(a)

Unusable character	Replacement characters	Remarks
% (Percent)	_PR_	When the 1st character of the symbol is "%", it is replaced with the replacement characters.
\$ (Dollar)	_DR_	When the 1st character of the symbol is "\$", it is replaced with the replacement characters.
: (Colon)	_CR_	":" in the symbol is replaced with the replacement characters.
; (Semicolon)	_SC_	";" in the symbol is replaced with the replacement characters.
. (Period)	_PE_	"." in the symbol is replaced with the replacement characters.

- Replacement of the symbol character of the ladder data (Identification code: %@3)

Table 11.5(b)

Unusable character	Replacement characters	Remarks
% (Percent)		"%" cannot be used for the 1st character of the symbol. Reason) - The same as the identification code. - The same as the address of extended function. Replace the unusable characters in the mnemonic file.
\$ (Dollar)	_DR_	When the 1st character of a symbol is "\$", it is replaced to the replacement characters.
: (Colon)		":" cannot be used for the symbol. Reason) The character before ":" is deleted. Replace the unusable characters in the mnemonic file.
; (Semicolon)		";" cannot be used for the symbol. Reason) The character after ";" is deleted. Replace the unusable characters in the mnemonic file.
. (Period)	_PE_	"." in the symbol is replaced to the replacement characters.

- In conversion of the mnemonic, if you select the "Label/Subprogram", the ladder data is outputted in the symbol. If you select the "P-G Compatible" and the "Full Options", the ladder data is outputted in the address. When you convert the ladder of the non-extended function into the extended function, select the "Full Options" and convert into the mnemonic.
- In case of mnemonic file of extended function, whose ID is "%2-D", converting such characters in a symbol causes an error.

11.6 CONVERTING TO MNEMONIC

Converting a source data into a mnemonic file.

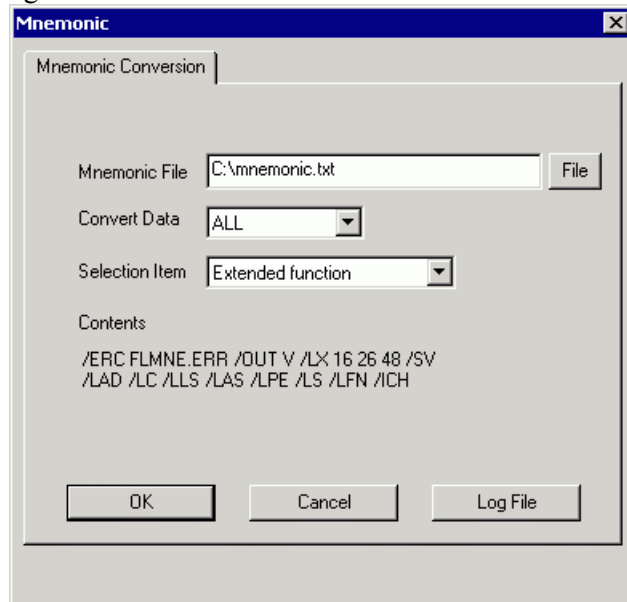

Fig. 11.6

Select the format of a mnemonic file by the **Selection Item**.
Select the **Extended function** when using an extended function.
The output by conventional model is possible for the ladder where an error does not occur at compiling.

11.7 SYSTEM PARAMETER

11.7.1 Set of Display Language for Comment

You can describe up to four sets of comments for each symbol data. These sets of comments can have their attributes of language, so that they can be switched dynamically to be displayed on the ladder screen and so on, according to the language setting of CNC. They can also have an attribute of a specific screen, so that they will be used in the screen for a specific purpose.

You can define the attributes of comment sets at **Language for Comment** in System Parameter.

Procedure

1. Double-click the <System parameter> item in the [Program List] screen. The [Edit System Parameter] screen appears.
2. Click the **Language for Comment** button.

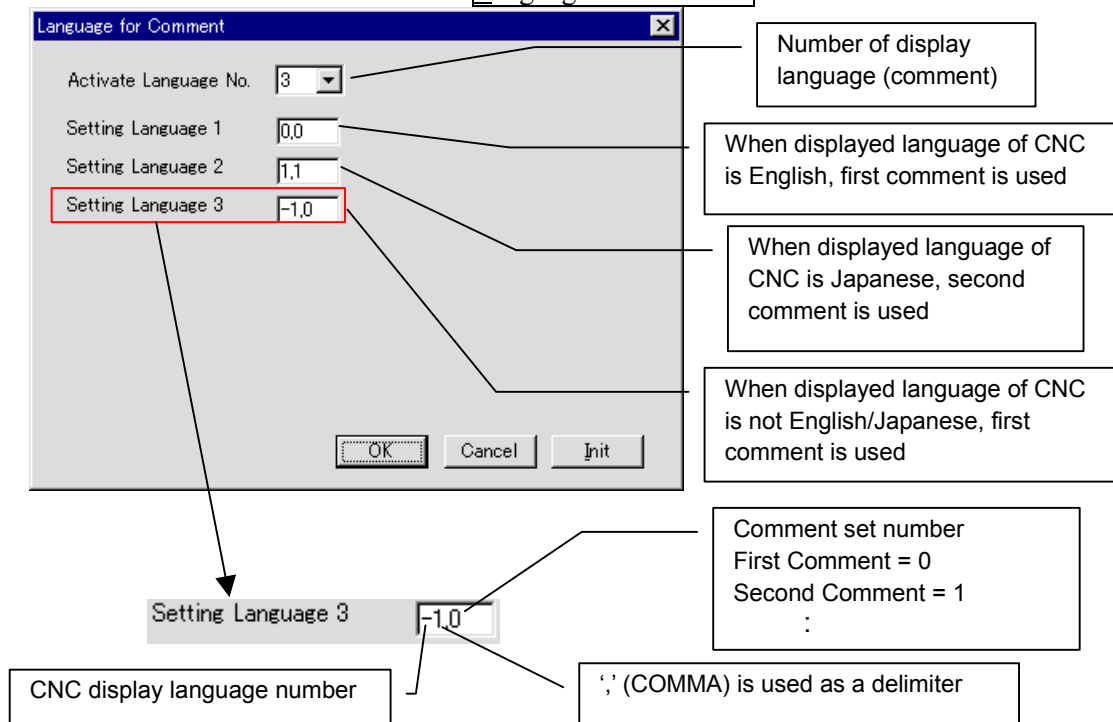

Fig. 11.7.1

0: English	8: Dutch
1: Japanese	9: Danish
2: German	10: Portuguese
3: French	11: Polish
4: Chinese	12: Hungarian
5: Italian	13: Swedish
6: Korean	14: Czech
7: Spanish	-1: other
	100 REMARK in I/O Diagnosis screen

11.8 COMPILATION

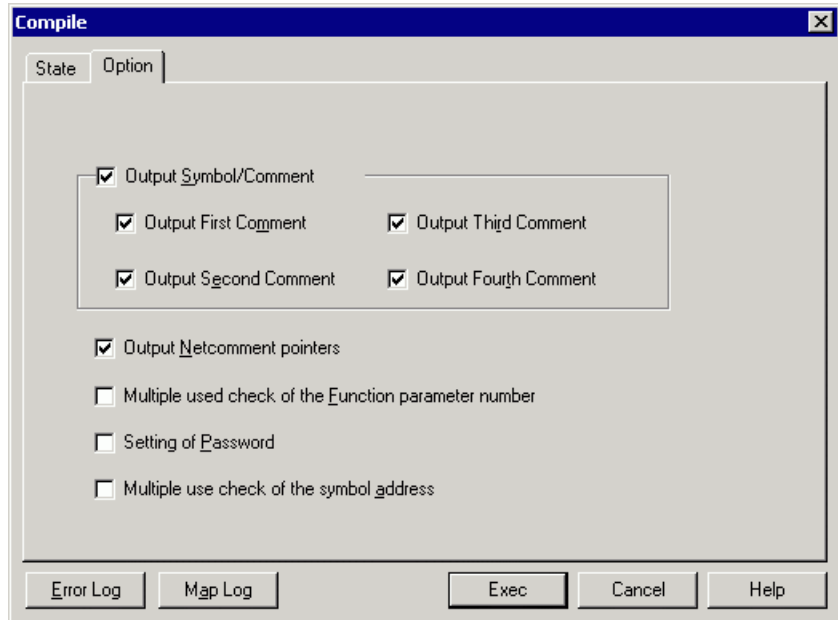

Fig. 11.8

A specification whether to output the 3rd comment and 4th comment is added.

You can describe up to four sets of comments for each symbol data. These sets of comments can have their attributes of language, so that they can be switched dynamically to be displayed on the ladder screen and so on, according to the language setting of CNC. They can also have an attribute of a specific screen, so that they will be used in the screen for a specific purpose.

You can define the attributes of comment sets at Language for Comment in System Parameter.

0: English	8: Dutch
1: Japanese	9: Danish
2: German	10: Portuguese
3: French	11: Polish
4: Chinese	12: Hungarian
5: Italian	13: Swedish
6: Korean	14: Czech
7: Spanish	-1: other
	100 REMARK in I/O Diagnosis screen

Multiple use check of the symbol address

Checked : It is checked that two or more symbols are defined in one address.

Not checked : It is not checked that two or more symbols are defined in one address.

11.9 DECOMPILATION

A specification of the 3rd and 4th comment about method to merge at de-compiling is added to the Detail.

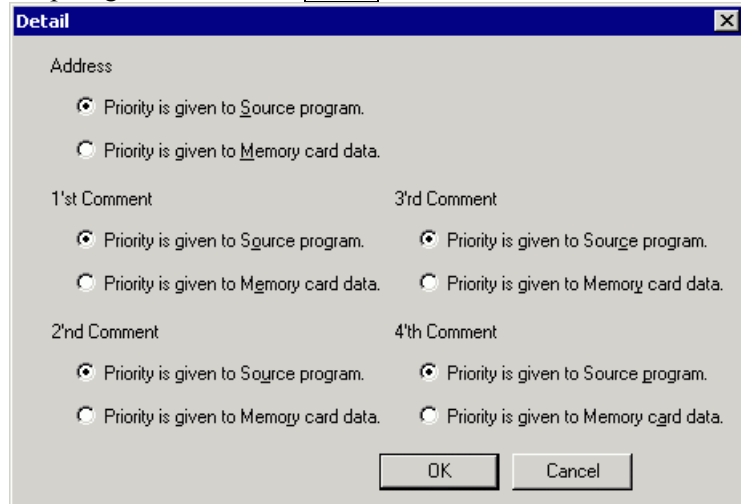

Fig. 11.9

11.10 PRINTING

11.10.1 Printing the System Parameters

The contents of the automatic assignment of address are always printed.

```

12) BASIC GROUP COUNT ( 0-16 )
13) SELECTABLE I/O LINK (CHANNEL 4) NO USE
14) BASIC GROUP COUNT ( 0-16 )
15) Activate Language No. 1 ( 1-16 )
16) Setting Language1 -1,0
17) Automatic Assignment of Address YES ( 0:NO, 1:YES )
18) R address BOOL R0100 - R0119
19) BYTE
20) WORD
21) DWORD
22) D address BOOL
23) BYTE
24) WORD
25) DWORD
26) E address BOOL
27) BYTE
28) WORD
29) DWORD

PMC TYPE = 30i-A PMC (EXT)
    
```

Fig. 11.10.1

11.10.2 Printing the Symbol Comment

Prints the symbol comment

There are two kind of printing formats.

Table 11.10.2

Print format	Description
All	All the symbols and the comment data are printed.
1 line	Printed as a single line. The symbol is printed up to 24 characters and the comment is up to 40 characters.

Procedure

1. Select the [Print] of the [File] menu.
2. Select the <Option> button of the [Print] dialog box.
3. Select the [Symbol Comment] tab of the [Option] dialog box.
4. Choose the **All** or the **1 Line** of the [Selection of print format]

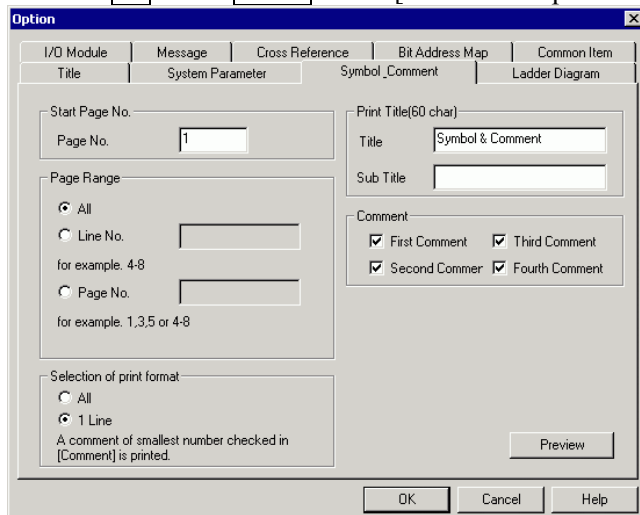

Fig. 11.10.2

11.10.3 Printing the Ladder Diagram

Prints the Ladder Diagram. The symbol is printed up to 16 characters and the comment is up to 30 characters. The Relay/Coil, the Coil Comment, and the Subprogram Comment can be specified.

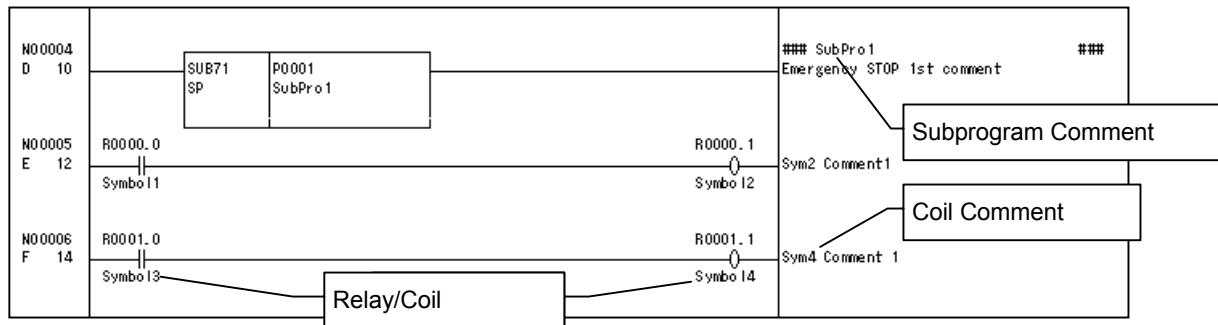

Fig. 11.10.3(a)

Procedure

1. Select the [Print] of the [File] menu.
2. Select the <Option> button of the [Print] dialog box.
3. Select the [Ladder Diagram] tab of the [Option] dialog box.
4. Click the <Details> button.
5. Use the **Relay/Coil**, the **Coil Comment** or the **Subprogram Comment**.

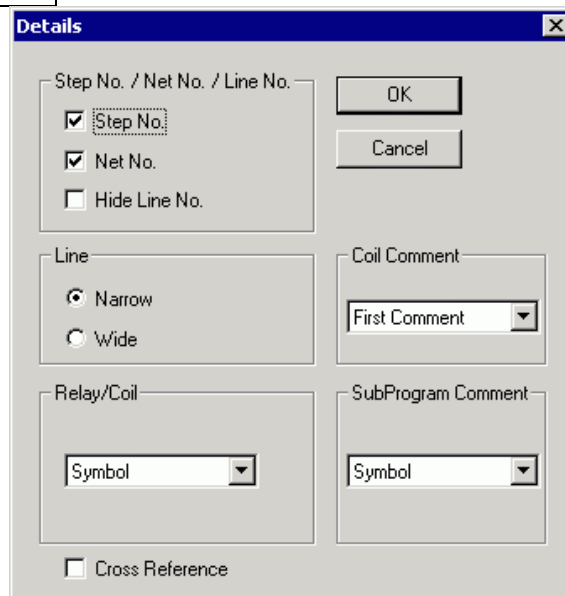

Fig. 11.10.3(b)

11.10.4 Printing Cross Reference

Prints the Cross Reference of the Address. The symbol is printed up to 16 characters and the comment is up to 30 characters. When both the global symbol and the local symbol are defined as the same signal, only the global symbol is displayed.

The printed comment can be specified.

Procedure

1. Select the [Print] of the [File] menu.
2. Select the <Option> button of the [Print] dialog box.
3. Select the [Cross Reference] tab of the [Option] dialog box.
4. Click the <Details> button.
5. Use the **Comment**.

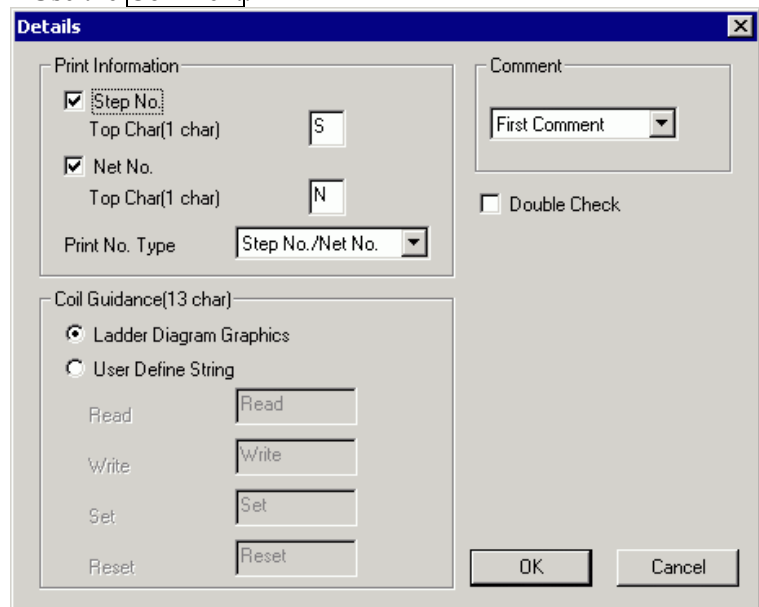

Fig. 11.10.4

11.10.5 Printing the Bit Address

1. The symbol is printed up to 16 characters.
2. The global symbol is printed.
3. The local symbol is not printed. (Note: The use situation of the address is printed.)

11.11 SIGNAL STATUS

Procedure

1. Select [Diagnose] – [Signal Status]. The [Signal Status] screen appears.

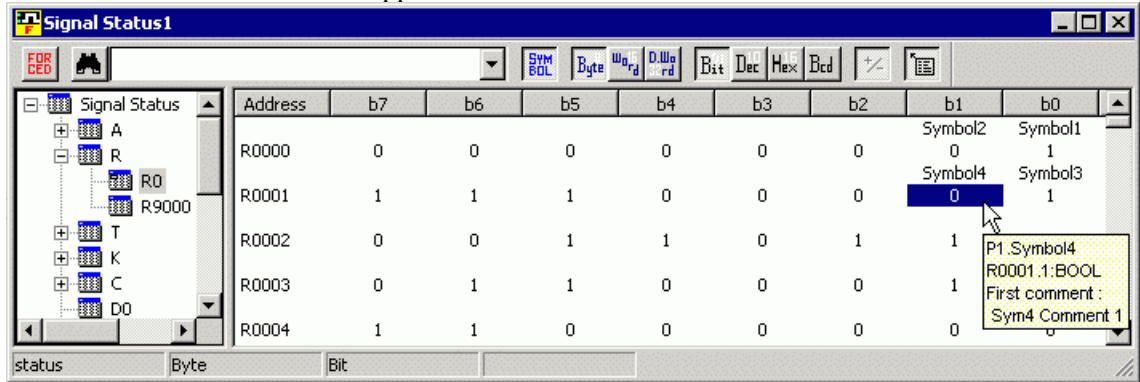

Fig. 11.11

11.11.1 Toolbar



Fig. 11.11.1

- <1> Switches between the status screen and forced I/O screen.
- <2> Search button
- <3> Combo box for inputting the character string for which a search is to be made.
To search a local symbol "ABC" in P1, Input "P1.ABC".
- <4> Symbol indication (off ↔ on)
- <5> Display format: Byte
- <6> Display format: Word
- <7> Display format: Double word
- <8> Display type: Binary
- <9> Display type: Decimal
- <10> Display type: Hexadecimal
- <11> Display type: BCD
- <12> Sign indication (off ↔ on)
(Valid only when decimal notation is set as the display type.)
- <13> ToolTips indication (off ↔ on)
When the cursor is on an address, detailed information of the address is shown if ToolTips indication is turned on.

11.12 T ADDRESS (TIMER)

11.12.1 Toolbar

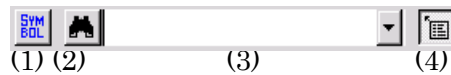

Fig. 11.12.1(a)

- <1> Symbol indication (off ⇔ on)
- <2> Search
- <3> Combo box for inputting the character string for which a search is to be made.
To search a local symbol "ABC" in P1, Input "P1.ABC".
Units of the displayed timer value (ms, sec, min)
- <4> ToolTips indication (off ⇔ on)
When the cursor is on an address, detailed information of the address is shown if ToolTips indication is turned on.

11.13 C ADDRESS (COUNTER)

11.13.1 Toolbar

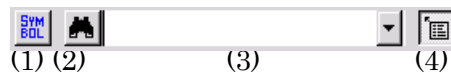

Fig. 11.12.1(a)

- <1> Symbol indication (off ⇔ on)
- <2> Search
- <3> Combo box for inputting the character string for which a search is to be made.
To search a local symbol "ABC" in P1, Input "P1.ABC".
- <4> ToolTips indication (off ⇔ on)
When the cursor is on an address, detailed information of the address is shown if ToolTips indication is turned on.

11.14 K ADDRESS (KEEP RELAY)

11.14.1 Toolbar

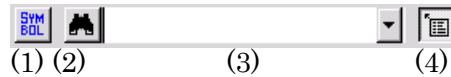

Fig. 11.14.1

- <1> Symbol indication (off ⇔ on)
- <2> Search
- <3> Combo box for inputting the character string for which a search is to be made.
To search a local symbol "ABC" in P1, Input "P1.ABC".
- <4> ToolTips indication (off ⇔ on)
When the cursor is on an address, detailed information of the address is shown if ToolTips indication is turned on.

11.15 D ADDRESS (DATA TABLE)

11.15.1 Toolbar



Fig. 11.15.1

- <1> Symbol indication (off ⇔ on)
- <2> Search
- <3> Combo box for inputting the character string for which a search is to be made.
To search a local symbol "ABC" in P1, Input "P1.ABC".
- <4> Display format: Byte
- <5> Display format: Word
- <6> Display format: Double word
- <7> Display type: Binary
- <8> Display type: Decimal
- <9> Display type: Hexadecimal
- <10> Display type: BCD
- <11> Sign indication (off ⇔ on)
(Valid only when decimal notation is set as the display type.)
- <12> Write protection
- <13> ToolTips indication (off ⇔ on)
When the cursor is on an address, detailed information of the address is shown if ToolTips indication is turned on.

11.16 SIGNAL TRACING

11.16.1 Toolbar



Fig. 11.16.1

- <1> Trace parameter setting button.
Displays the [Trace Parameter Setting] dialog box.
- <2> Trace start button
Starts or stops tracing.
When this button is in the up state, tracing is stopped.
When the button is in the down state, tracing is executed.
* When the trace function is being executed, the <Trace start> button is in the down state.
- <3> Symbol on/off button
Sets the display format of the trigger and sampling addresses.
When the symbol format is selected, the button is in the down state; when the address format is selected, the button is in the up state.
- <4> Marking button
Marks the cursor position at that time and displays the mark cursor. When the mark cursor and current position cursor overlap one another, the current position cursor is displayed. At the bottom of the screen, [Mark position], the mark cursor position, and [Range], the range from the mark cursor position to the current position cursor, are displayed.
- <5> <6> Zoom button
Magnifies or reduces graphs.
- <7> Grid line button
Specifies whether to display grid lines.
- <8> <9> Up-and-down replacement button
Clicking the [UP] button replaces the trace result at the address cursor with the line immediately above.
Similarly, clicking the [DOWN] button replaces the trace result with the line immediately below.
- <10> <11> Search button
Searches the trace display area for the specified time or frame number.
- <12> First trace result button
Moves the cursor at the beginning of the trace result.
- <13> Previous trace result button
Scrolls the trace result display up by one page.
- <14> Next trace result button
Scrolls the trace result display down by one page.
- <15> Last trace result button
Moves the cursor at the end of the trace result.
- <16> ToolTips indication (off ↔ on)
When the cursor is on an address, detailed information of the address is shown if ToolTips indication is turned on.

11.17 TOOLTIPS INDICATION

Symbol and comment of addresses are displayed.

Local symbol is shown as "P address.Symbol" which added a period between P address and Symbol.

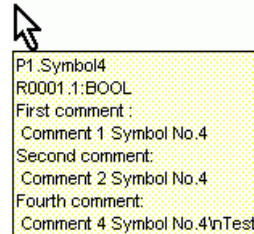

Fig. 11.17

Program, Symbol, address, type and comment are displayed.

Maximum number of character is 40.

For about the comment data, space character is added to the top of strings, and '\n' indicates the new line code.

To specify the font size of ToolTips indication, Use [ToolTips font].

[ToolTips font] will appear by clicking <Details...>button in [Tool] – [Option] – [Ladder] tab.

11.18 MNEMONIC FILE FORMAT

The mnemonic file format of Extended functions is added.

Table 11.18

Conversion name	Data kind	Identification code	The contents of change
P-G Compatible Full Options Label / Sub program	Symbol and comment	%@2 %@2-C %@2-C2	FORMAT-A/B FORMAT-C (Relay comment, Comment) FS30i (Comment 1, Comment 2)
	Ladder	%@3	
Extended functions	System parameter	%@0	<ul style="list-style-type: none"> Model information was added. Automatic assignment of address was added.
	Symbol and comment	%@2-D	<ul style="list-style-type: none"> Structure of a symbol subject. The local symbol and the global symbol were added. Type information was added. The comment set was extended to four.
	Ladder	%@3-D	<ul style="list-style-type: none"> It corresponded to the address and the symbol. It corresponded to the local symbol and the global symbol.

11.18.1 System Parameter

The following information is added.

- Model information was added.

Table 11.18.1(a)

Setting data	Description
4 30i-A PMC(EXT)	1st-path PMC Extended functions
4 30i-A PMC(2nd,EXT)	2nd-path PMC Extended functions
4 30i-A PMC(3rd,EXT)	3rd-path PMC Extended functions
4 30i-A PMC(DCS,EXT)	Dual Check Safety PMC Extended functions

- Automatic assignment of an address was added.

Table 11.18.1(b)

Setting data	Description
100 YES	100 : Yes or no of automatic assignment (Valid : YES, Invalid : NO)
101 R100-R199	101 : BOOL of R address (Character string R100-R199)
102 R700-R799	102 : BYTE of R address
103 0-0	103 : WORD of R address
104 0-0	104 : DWORD of R address
111 D100-D149	111 : BOOL of D address (Character string D100-D149)
112 D200-D299	112 : BYTE of D address
113 0-0	113 : WORD of D address
114 0-0	114 : DWORD of D address
121 E0-E199	121 : BOOL of E address (Character string E0-E199)
122 0-0	122 : BYTE of E address
123 0-0	123 : WORD of E address
124 0-0	124 : DWORD of E address

In "100 NO", 101-124 are not outputted.

(Example)

In case of the Extended functions of 30i-A PMC (the 1st-path PMC).

%@0		
2 BINARY	2 : Counter data type	(BINARY or BCD)
3 NO	3 : Yes or no of Operator panel	(Valid : YES, Invalid : NO)
4 30i-A PMC	4 : PMC Type	(30i-A PMC)
31 1	31 : The setting number of display language(Comment)	(1-16)
32 -1	32 : CNC display language number 1	(-1, 0-127)
33 0	33 : Comment set number 1	(0-16)
100 YES	100 : Yes or no of automatic assignment	(Valid : YES, Invalid : NO)
101 R100-R199	101 : BOOL of R address	(Character string R100-R199)
102 R700-R799	102 : BYTE of R address	
103 0-0	103 : WORD of R address	
104 0-0	104 : DWORD of R address	
111 D100-D149	111 : BOOL of D address	(Character string D100-D149)
112 D200-D299	112 : BYTE of D address	
113 0-0	113 : WORD of D address	
114 0-0	114 : DWORD of D address	
121 E0-E199	121 : BOOL of E address	(Character string E0-E199)
122 0-0	122 : BYTE of E address	
123 0-0	123 : WORD of E address	
124 0-0	124 : DWORD of E address	
%		

11.18.2 Symbol Comment

```
%@2-D
Symbol   Address:Type
$1 'Comment 1'
$2 'Comment 2'

$LEVEL1
Symbol   Address:Type
$2 'Comment 2'
%
```

- Describe an address and a symbol in the same line. A symbol has to be described at the head of a line, puts a space or a tab as a delimiter character, and describes an address.
- Describe the type of a symbol after ":" of an address. If the type of a symbol is omitted, it will change to BOOL or BYTE according to the kind of address.
- Input the space and address to set up only a comment.
- "\$LEVEL1" and "\$P1" or subsequent ones are local symbols.
- "\$1" is the 1st comment and "\$2" is the 2nd comment. The character string surrounded with the single quotation mark is a comment.

CAUTION

- 1 Please input a symbol and a comment from the 1st character. Any blank should not precede.
- 2 When using a single quotation mark "" into the character string of a relay comment and a coil comment, dollar + single quotation mark "\$"+ "" describes.
- 3 When you use yen symbol "\" (backslash) by a comment into a comment text, please describe it as two "\\."

```
%@2-D
INITIALIZE           L0100:LABEL
$1 'INITIALIZE OF SEQUENCE'
OPEN-FRONT          P0008:PROG
$2 'OPEN FRONT COVER'
UNIT-2-ACT          R0200.1:BOOL
$1 'KEEP UNIT-4 $$POWER$' ON'
$2 '$POWER$$'
UNIT-3-POWER        R0200.0:BOOL
$1 'KEEP UNIT-3 POWER ON'
$2 'KEEP POWER ON'

$LEVEL1
*ESP                G0008.4:BOOL
$1 'Emergency STOP'
Work1               R0100.0:BOOL
$1 'Work signal\nTest'
%
```

11.18.3 Ladder

Extended functions

```

%@3-D
LABEL1  END1
        LBL                               ;<L100  >
                                           ;[LABEL L00001]
        END2
SUBPR1  SP                               ;<P1    > "SUB PROG. NO.01"
                                           ;[SUB PROGRAM DATA NO.01]
        RD      XADRS1                   ;<X0.0  > "JUMPB LABEL L001"
        JMPB    LABEL1                   ;<L100  >
                                           ;[LABEL L00001]
        RD      XADRS2                   ;<X0.1  > "JMPC LABEL L001"
        JMPC    LABEL1                   ;<L100  >
                                           ;[LABEL L00001]
LABEL1  LBL                               ;<L100  >
                                           ;[LABEL L00001]
SP1000  SPE
        SP                               ;<P2    > "SUB PROGRAM NO.1"
        RD      RADRS00                   ;<R0.0  >
        DEC     DADRS04                   ;<D0    >
                                           2
        WRT     %D0.0
        SPE
        END
%
```

CAUTION

- 1 Please input the parameter of LBL and SP instruction from the 1st character.
- 2 Please be sure to put in the space or a tab before a basic instruction and a functional instruction.
- 3 The character before a ":" (colon) is disregarded. The character after a ";" semicolon is also disregarded.
- 4 Please attach "%" (percent) to an address.

11.19 HOW TO CONVERT FROM CONVENTIONAL MODEL

To convert the LAD file from conventional model to extended function, convert to the ladder via mnemonic file.

11.19.1 Converting Mnemonic File

Create mnemonic file from the LAD file of conventional model.

Procedure

1. Open the LAD file of conventional model with FANUC LADDER-III.
2. Click [Tool(T)] - [Mnemonic Conv(M)].
3. Open [Mnemonic] screen.

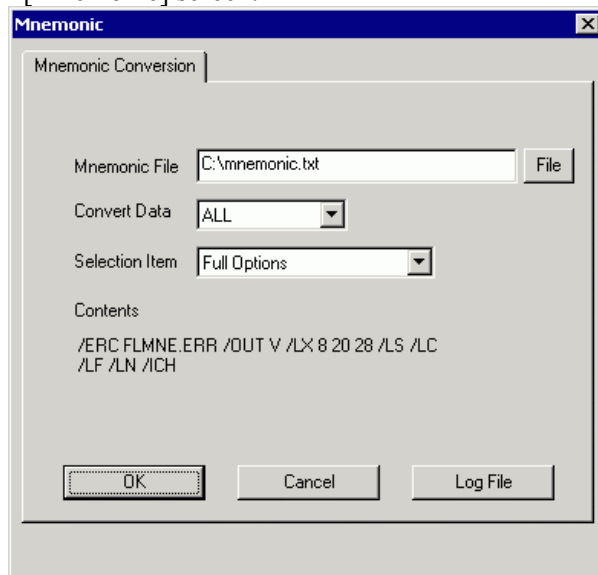

Fig. 11.19.1

4. Enter [Mnemonic File], [Convert Data Kind] and [Selection Item] and click the <OK> button, then the mnemonic file is output.

11.19.2 Create Ladder Program of Extended Function and Change to Source File.

Create a new LAD file and read the mnemonic file

Procedure

1. Boot FANUC LADDER-III
2. Click [File(F)] - [New Program(N)]

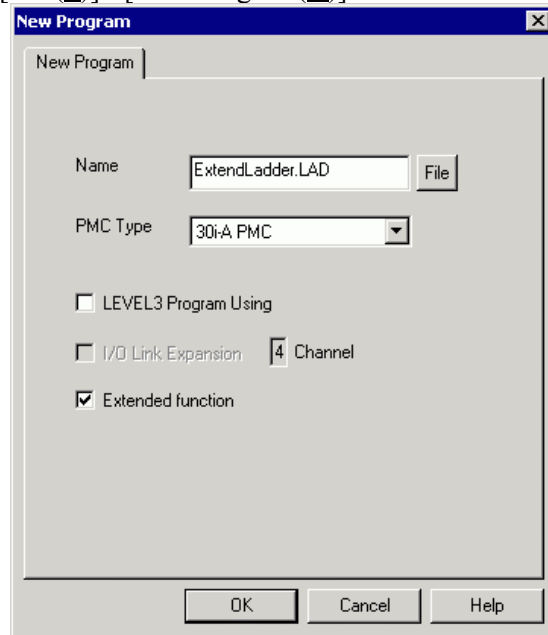

Fig. 11.19.2(a)

3. Check [Name], [PMC type] and **Extended function** and push <OK> button.
4. Click [Tool(T)] - [Source Program Convert(S)]

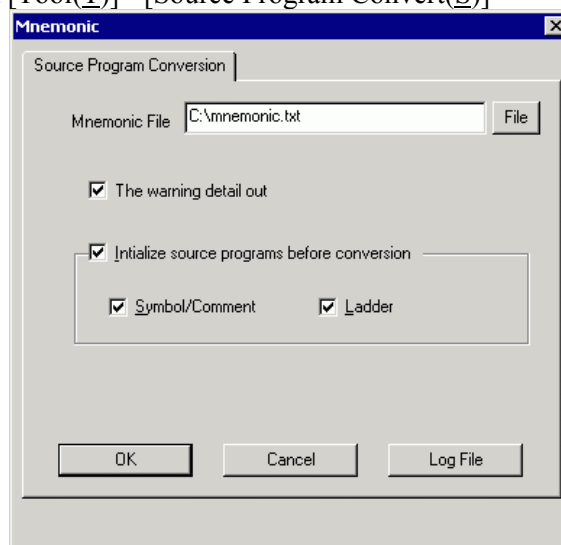

Fig. 11.19.2(a)

5. Enter [mnemonic file] and click <OK> button.
6. Confirm ladder data is converted.

12

CONVERTING SEQUENCE PROGRAMS

This chapter describes how to convert DOS-version FANUC LADDER-II and FANUC LADDER-III sequence programs.

12.1 CONVERTING FROM DOS-VERSION FANUC LADDER-II

This section describes how to convert DOS-version sequence programs to the Windows version.

12.1.1 Procedure

1. Select [Tool] – [Data Conversion.]
2. On the pull-down menu, select [Data File → LAD File]. The [Conversion into LAD Format File] screen appears.

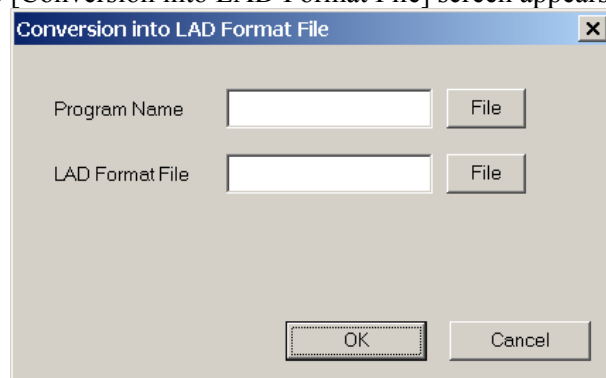

Fig. 12.1.1

- 2-1 Input the required data.

Program Name

Enter the name (folder name) of the DOS-version sequence program you want to convert.

LAD Format File

Enter the name of the Windows-version sequence program you want to create by the conversion. Use the extension .LAD. You can omit the extension, however.

3. To convert, click the <OK> button.
To abandon the conversion, click the <Cancel> button.

If an LAD file opened by another user is specified, the following error messages are displayed, and data conversion is terminated:

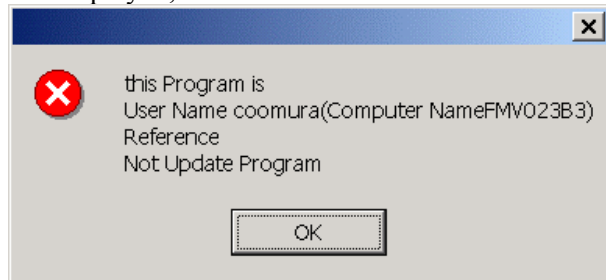

Fig. 12.1.1(b)

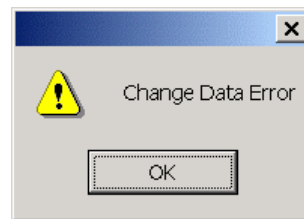

Fig. 12.1.1(c)

If an LAD file that has the read-only attribute is specified, the following error messages are displayed, and data conversion is terminated:

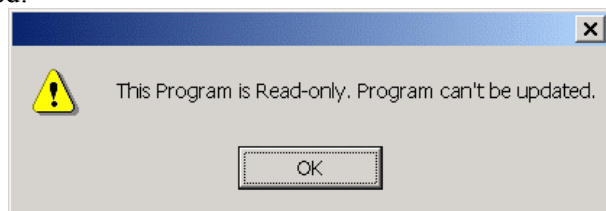

Fig. 12.1.1(d)

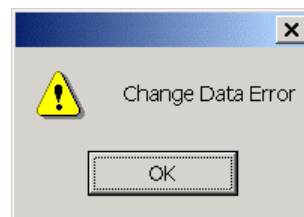

Fig. 12.1.1(e)

12.2 CONVERTING TO DOS-VERSION FANUC LADDER-II

This section describes how to convert Windows-version sequence programs to the DOS version.

12.2.1 Procedure

1. Select [Tool] – [Data Conversion.]
2. On the pull-down menu, select [Data File ← LAD File].
The [Conversion into Program Data File] screen appears.

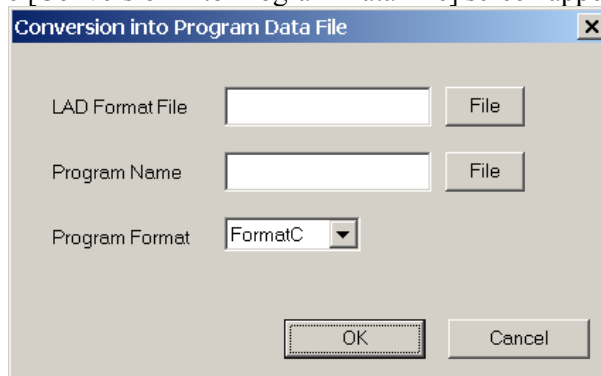

Fig. 12.2.1

- 2-1 Input the required data.

LAD Format File

Enter the name of the Windows-version sequence program you want to convert. Use the extension .LAD. You can omit the extension, however.

Program Name

Enter the name (folder name) of the DOS-version sequence program you want to create by the conversion.

Program Format

Select format A, B, or C.

3. To convert, click the <OK> button.
To abandon the conversion, click the <Cancel> button.

NOTE

- 1 For conversion to FANUC LADDER-II sequence programs, select FormatC for Program Format.
- 2 Any sequence program on the PMC-SB7 cannot be converted to a sequence program of FANUC LADDER-II.

12.3 CONVERTING SEQUENCE PROGRAMS BETWEEN PMC MODELS

Converting a mnemonic file enables it to be used as a sequence program for another PMC model.

12.3.1 Conversion by Changing System Parameters

For the following PMC models, changing the system parameters in a mnemonic file enables a sequence program for another PMC to be edited. However, the format of the system parameters, the function instructions that can be used, and the range of addresses vary from one PMC model to another.

Table 11.3.1

CNC model	PMC from which conversion is possible
FS16/18/20-B FS16/18/21-C FS16/18/21 <i>i</i> -A FS16/18/21 <i>i</i> -B	PMC - SA1 / SA3 / SA5 / SB3 / SB4 / SB5 / SB6 / SB7 SC3 / SC4
Power Mate-D/F/H Power Mate <i>i</i> -D/H	PMC - PA1 / PA3 / SB5 / SB6
FS15-B FS15 <i>i</i>	PMC - NB / NB2 / NB6

NOTE

It is impossible to convert step sequence data.

Example of conversion (PMC-SB3 → PMC-SC3)

1. On FANUC LADDER-III, set PMC-SB3 as the device, and convert the source program to be converted into a mnemonic file.
2. In the resulting mnemonic file, change the settings of system parameters to PMC-SC3, using a general-purpose text editor.
3. On FANUC LADDER-III, set PMC-SC3 as the device, and open a new source program.
4. Convert the mnemonic file modified in 2. into the source program opened in 3.
5. On the Edit System Parameter screen, return the values of system parameters to the previous ones.

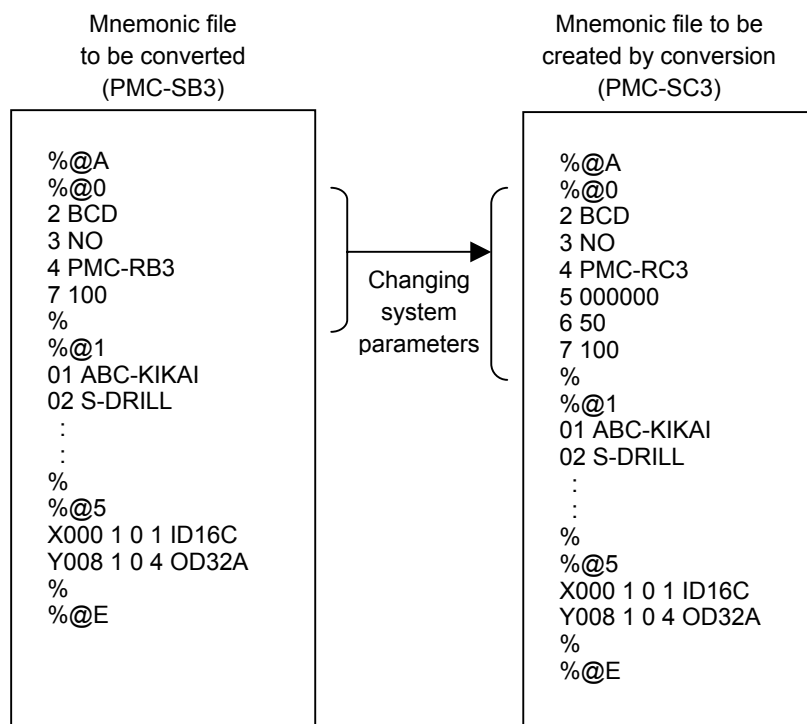

NOTE

For an explanation of the setting items of the system parameter section of each model, see Subsection 6.4.1.1, "Parameter" in Section 6.4, "MNEMONIC FILE SAMPLE".

12.3.2 Using System Program Data for Another Program

The following method makes the data (title, symbols, comments, ladders, messages, and I/O module data) of a sequence program usable as data for another sequence program.

However, the range of addresses varies from one model to another. Refer to the applicable programming manual for each individual model for a detailed explanation about how to change the range of their addresses.

[Example: Making symbol and comment data for the PMC-SB usable for with PMC-SC3]

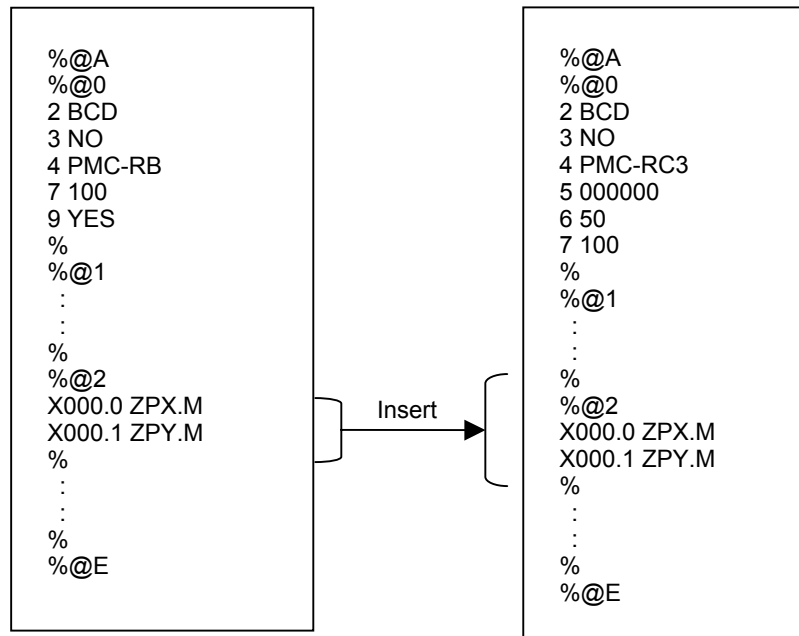

13

ERROR MESSAGES

This chapter describes the error messages that may be displayed by FANUC LADDER-III.

13.1 ERROR MESSAGE FORMAT

FANUC LADDER-III outputs error messages in the following format:
Function symbol:Classification-Four-digit-code Error message
character strings

13.1.1 Function Symbols

The function for which an error occurred is represented using one alphabetic character.

Function symbol	Function name	Function screen
A	File	Create new program Open program Update program Save Import Export Data conversion
B	Title editing	Edit title
C	I/O module editing	Edit I/O module
D	System parameter editing	Edit system parameter
E	Ladder/step sequence editing	Edit ladder Ladder monitor
F	Symbol/comment editing	Edit symbol/comment
G	Message editing	Edit message
H	Print	Print Print preview
I	Compile	Compile
J	Decompile	Decompile
K	Mnemonic editing	Mnemonic conversion Source program conversion
L	Input/output	Load from PMC Store in PMC Backup
N	Online	Signal status PMC parameter timer PMC parameter counter PMC parameter keep relay PMC parameter data table PMC parameter setting PMC alarm status PMC status Signal trace Signal analysis Run program Stop program Communication I/O Link start Clear PMC area

13.1.2 Message Classification

A message type is represented using one alphabetic character.

Classification	Type	Description	No.
F	Fatal error	State in which the system is operational, but cannot continue processing due to a reason such as there being an invalid user program	2xxx 5xxx
E	Error	State in which processing continues but with no results produced, or in which processing is stopped	3xxx 6xxx
W	Warning	State in which processing continues with results produced, but in which the results are unpredictable	4xxx 7xxx

13.2 ERROR MESSAGES

13.2.1 File

Error code	Message	Cause/action
A:F-2000	Insufficient memory	
A:F-2001	Insufficient disk space	
A:F-2004	This data can not be handled at this version of FANUC LADDER	
A:F-2005	Source program has wrong file	The source program includes an invalid file or does not include a necessary file. Check the file configuration of the source program.
A:F-2006	Not found **** file	
A:F-2007	Not found **** Source program	
A:F-2008	Cannot open **** file	
A:F-2009	Cannot close **** file	
A:F-2010	**** Source program broken	
A:E-3120	Enter program name	No source program is entered. Enter the name of the desired source program.
A:E-3121	The source program does not exist	
A:E-3122	PMC model file is not found	A source program for an unsupported model was entered. Check the models supported by this system. Some system files (****.TBL) are not found. Reinstall.
A:E-3124	Cannot create new program ****	An entered source program cannot be created. A source program cannot be created if a folder with the same name already exists. Enter another program name.
A:E-3125	Illegal path of source program name	A specified path is not found. Check the entered source program name.
A:E-3126	Source program type is different	In source program copy operation, a program of FORMAT-A/B was specified. FORMAT-A/B cannot be used with FANUC LADDER-III. Convert the program by using the data conversion function of the [Tool] menu.
A:E-3127	Mismatched password	
A:E-3128	**** file read error	The **** file cannot be read.
A:E-3130	**** file read error. Hit any key	The **** file cannot be read.
A:E-3131	**** file open error	The **** file cannot be opened.
A:E-3132	**** file close error	The **** file cannot be closed.
A:E-3133	insufficient disk error	A file cannot be output due to there being insufficient disk capacity. Terminate the system, and then the free up space on the disk.
A:E-3134	Invalid option initialized.(**** file was updated.	The option file was initialized because its data was destroyed.
A:E-3135	Program conversion error.(ROM → Memory card) Hit any key	
A:E-3136	Program conversion error.(Memory card → ROM) Hit any key	
A:E-3137	Cannot create file ****	The **** file could not be created.
A:E-3138	Illegal source program name	
A:E-3139	Illegal **** source program name	
A:E-3140	Not found file	
A:E-3141	Not found **** PMC-OS file	
A:E-3143	Cannot open file	The **** file cannot be opened.

Error code	Message	Cause/action
A:E-3144	Cannot close file	The **** file cannot be closed.
A:E-3145	File I/O error	A file access error occurred.
A:E-3146	**** file I/O error	
A:E-3147	Unknown PMC series	
A:E-3148	**** file write error. Hit any key.	The **** file cannot be written to.
A:E-6000	Illegal folder name	Specify an existing folder as the export destination for a user file.
A:E-6001	PMC type is different	When an LAD file is imported, the PMC model of the import source must match that of the open program.
A:E-6002	Export Ladder File is protected	Deselect the ladder file from export targets.
A:E-6003	Import Ladder File is protected	Deselect the ladder file from import targets.
A:E-6004	Export Sub program File is protected	Deselect the sub-program file from export targets.
A:E-6005	Import Sub program File is protected	Deselect the sub-program file from import targets.
A:E-6006	Fail to delete file	Check whether the file you attempt to delete is used with another system.
A:W-7000	Net comment can be selected when all data is selected	Select all the data files, ladder diagrams, and sub-programs to import a net comment.
A:W-7001	No timer available	Since the timer cannot be used, the status bar display cannot be updated. FANUC LADDER-III can be executed normally.

13.2.2 Title Editing

Error code	Message	Cause/action
B:E-3020	File read error. Hit any key	The title file (TITLE) of a source program cannot be read.
B:E-3021	File write error. Hit any Key	The title file (TITLE) or control file (CONTROL) of a source program cannot be written to.
B:E-3022	File I/O error. Hit any key	A file access error occurred.

13.2.3 I/O Module Editing

Error code	Message	Cause/action
C:E-3021	File read error. Hit any key	The I/O module file (IOMODULE) of a source program cannot be read.
C:E-3022	File write error. Hit any key	The I/O module file (IOMODULE) or control file (CONTROL) cannot be written to.
C:E-3023	Input data invalid	Check the input method.
C:E-3024	Appointed Group not exist	Check the input range.
C:E-3025	Appointed Base not exist	Check the input range.
C:E-3026	Appointed Slot not exist	Check the input range.
C:E-3027	Appointed ID Code not exist	The entered module does not exist. Check the usable modules.
C:E-3028	Input key not used	
C:E-3030	Address appoint illegal	This address does not allow the entered module to be used. Check if an output module is entered in address X, or if an input module is entered in address Y.
C:E-3032	The same group base and slot are already specified	A module is already set in the entered group, base, and slot. The same group, base, and slot cannot be set more than once. Specify a different group, base, or slot.
C:E-3033	Invalid Channel No. appoint	Check the usable channels.

Error code	Message	Cause/action
C:E-3034	Invalid data except '0' is specified at the slot of * as I/O UNIT B	I/O Unit-B (power-on/off information) can be set in slot 0 only. Reenter by specifying slot 0.
C:E-6011	Not Module	
C:E-6021	Module Data Delete Error	
C:E-6031	Get Module Data Error	
C:E-6032	Set Module Data Error	
C:E-6041	Get Module Comment Data Error	
C:E-6042	Set Module Comment Data Error	
C:E-6043	Module Comment Data Delete Error	
C:E-6050	Channel Data Delete Error	
C:W-4020	The same group base and slot are already specified	A module is already set in the entered group, base, and slot. The same group, base, and slot are set more than once. Check whether this poses a problem.
C:W-4021	Invalid data except '0' is specified at the base of I/O UNIT B	The I/O Unit-B module can be set in base 0 only.
C:W-4022	Both I/O UNIT-A and UNIT-B are specified in the same group	I/O Unit-A and I/O Unit-B cannot be specified in the same group.
C:W-7023	Both I/O UNIT-B and CONNECTION UNIT are specified in the same group	

13.2.4 System Parameter Editing

Error code	Message	Cause/action
D:E-3020	File read error. Hit any key	The system parameter file (SYSPARAM) of a source program cannot be read.
D:E-3021	File write error. Hit any key	The system parameter file (SYSPARAM) or control file (CONTROL) of a source program cannot be written to.
D:E-3022	Invalid value	
D:E-3023	Input data invalid	
D:E-3024	Operator panel address error	When the use of the FS0 operator's panel is set, set the following addresses: Key input address, LED output address, key bit image address, LED bit image address

13.2.5 Ladder/Step Sequence Editing

Error code	Message	Cause/action
E:F-2100	Cannot read **** file	
E:F-2101	Cannot write **** file	
E:F-2102	Cannot seek **** file	
E:E-3200	Illegal source code	
E:E-3201	Buffer size over	
E:E-3202	Number of nest branch too big	
E:E-3203	Number of branch too big	
E:E-3204	Size of table buffer too big	
E:E-3205	Unconnected step sequence diagram	
E:E-3206	Selected branch error	
E:E-3207	Parallel branch error	
E:E-3208	Syntax error	
E:E-3209	Step line syntax error	
E:E-3210	Transition line syntax error	

13.ERROR MESSAGES

B-66234EN/05

Error code	Message	Cause/action
E:E-3211	Cannot insert	
E:E-3212	Cannot make diagram	
E:E-3213	Horizontal line illegal	
E:E-3214	Jump forward check error	
E:E-3215	Check incomplete error	
E:E-3216	Chart sequence error	
E:E-3217	Chart start code error	
E:E-3218	Chart end code error	
E:E-3219	Jump close error	
E:E-3220	Horizontal line duplicate error	
E:E-3221	Branch unconnected error	
E:E-3222	Branch sequence error	
E:E-3223	Cannot copy diagrams	
E:E-3224	Cannot move diagrams	
E:E-3225	Illegal specified position	
E:E-3226	Strings not Found	
E:E-3227	Step Number Duplicate Error	
E:E-3228	Label Number Duplicate Error	
E:E-3229	Cannot delete temporary file	
E:E-3230	Same sub-program name exists	
E:E-3231	Input invalid	
E:E-3232	Expected address	
E:E-3233	Too deep nesting of sub-program	
E:E-3234	Illegal file name	
E:E-3235	Sub-program already entried	
E:E-3236	Cannot delete program	
E:E-3237	Cannot change data	
E:E-6035	Program data error.	
E:E-6036	Program size error (OPTION).	The size of a sequence program exceeded the size specified by an option. Reduce the size of the sequence program.
E:E-6037	PMC type unmatched.	Convert the model with the offline function.
E:E-6041	The communication to PMC is not ready.	Start communication.
E:E-6042	An alarm occurs on PMC	An alarm was issued on the PMC, so processing cannot be continued. Reset the alarm on the PMC.
E:E-6044	Cannot create temporary file.	
E:E-6045	Ladder size over (PMC) Error status = ****	The size of a ladder being edited exceeded the writable size on the PMC. Reduce the size of the ladder being edited.
E:E-6046	The program is not corresponding(PMC). status=****	A program being edited does not match the program on the PMC. By loading, storing, or restoring a program, ensure a match with the program on the PMC.
E:E-6047	An alarm occurs on PMC Error status = ****	An alarm was issued on the PMC, so processing cannot be continued. Check if the ladder data being edited is correct.
E:E-6048	Ladder data error (PMC). Error status = ****	A program does not match the program on the PMC. By loading, storing, or restoring a program, ensure a match with the program on the PMC.
E:E-6051	OBJECT BUFFER OVER	The sequence program is excessively large. Reduce the amount of ladder data.
E:E-6053	1ST LEVEL EXECUTE TIME OVER	

Error code	Message	Cause/action
E:E-6054	COM FUNCTION MISSING	The method of using function instruction COM (SUB9) is incorrect. Check that COM is paired with COME (SUB29) correctly.
E:E-6055	JUMP FUNCTION MISSING	The method of using function instruction JMP (SUB10) is incorrect. Check that JMP is paired with IMPE (SUB30) correctly.
E:E-6056	END FUNCTION MISSING	Function instructions END1, END2, END3, and END are incorrect. Check that the order of END1, END2, END3, and END is correct.
E:E-6057	PROGRAM NOTHING	
E:E-6058	LADDER BROKEN	A ladder is destroyed, so that it cannot be updated. Reenter the ladder.
E:E-6059	COIL NOTHING	
E:E-6060	CALL CALLU FUNCTION MISSING	Function instructions CALL and CALLU are incorrect. Create function instructions CALL and CALLU on the second level of a ladder or in a sub-program.
E:E-6061	COM FUNCTION MISSING (CALL SP)	Function instruction CALL or CALLU is found between function instructions COM (SUB9) and COME. CALL and CALLU cannot be created between COM and COME.
E:E-6062	JMP FUNCTION MISSING (SP)	The method of using function instruction JMP (SUB10) in a sub-program is incorrect. Check that JMP is correctly paired with JMPE (SUB30).
E:E-6063	SUB PROGRAM MISSING	The method of using function instruction SP is incorrect. Check that SP is paired with SPEED correctly.
E:E-6064	SP NO. DUPLICATE	The same sub-program number already exists. Change the sub-program number.
E:E-6065	SUB PROGRAM NOTHING	Create a sub-program.
E:E-6066	END FUNCTION NOTHING	Add the END instruction.
E:E-6067	SP FUNCTION MISSING	
E:E-6068	LBL COUNT OVER	Reduce the number of labels.
E:E-6069	LBL NO. DUPLICATE	The same label number already exists. Change the label number.
E:E-6070	LBL FUNCTION NOTHING (JMPB)	Function instruction LBL specified by JMPB is not found. Add the LBL function instruction.
E:E-6071	COM FUNCTION MISSING (JMPB)	Function instruction JMPB is found between function instructions COM and COME. No jump can be made beyond COM and COME. Ensure that JMPB is not inserted between COM and COME. Alternatively, also create specified function instruction LBL between COM and COME.
E:E-6072	JMPB FUNCTION MISSING	The JMPB instruction allows a jump to be made to a sub-program only. Ensure that a jump is made to a point within a sub-program.
E:E-6073	LBL FUNCTION NOTHING (JMPC)	Function instruction LBL, specified by JMPC, is not found. Add function instruction LBL.
E:E-6074	COM FUNCTION MISSING (LBL)	Specified function instruction LBL is found between function instructions COM and COME. A jump cannot be made to a point between COM and COME. Ensure that LBL is not inserted between COM and COME. Alternatively, also create function instruction JMPC between COM and COME.

Error code	Message	Cause/action
E:E-6075	JMPC FUNCTION MISSING	Function instruction JMPC is not specified in a sub-program. Create function instruction JMPC in a sub-program.
E:E-6076	LBL FUNCTION MISSING (JMPC)	Function instruction LBL, specified by function instruction JMPC, is not specified at the second level of a ladder. Create function instruction LBL at the second level of a ladder.
E:E-6077	An illegal program number is specified for the **** instruction.	Use a P address as the parameter of functional instruction ****.
E:E-6078	An illegal label number is specified for the **** instruction.	Use a L address as the parameter of functional instruction ****.
E:E-6080	LADDER ILLEGAL	A ladder is incorrect. Reenter the ladder.
E:E-6090	RELAY OR COIL FORBIT	An unnecessary relay or coil is set. Delete the relay or coil.
E:E-6092	HORIZONTAL LINE ILLEGAL	Connect the horizontal line of the net.
E:E-6093	FUNCTION LINE ILLEGAL	Connect the function instruction correctly.
E:E-6094	RELAY OR COIL NOTHING	A relay or coil is missing. Add a relay or coil.
E:E-6095	VERTICAL LINE ILLEGAL	Connect the vertical line of the net.
E:E-6096	PARAMETER NOTHING	The parameters of a function instruction are missing. Set the parameters.
E:E-6097	ADDRESS NOT DETECTED	Set an address.
E:E-6100	NET TOO LARGE	The net being edited has become larger than the edit buffer. Reduce the size of the net being edited.
E:E-6101	PLEASE COMPLETE NET	
E:E-6102	LARGE NET APPEARED	Reduce the size of the net.
E:E-6111	ERROR NET FOUND	Modify the error net.
E:E-6115	PARA NO. RANGE ERR	
E:E-6130	There is no CE instruction.	Although the functional instruction CS is used, there is no functional instruction CE that means the end.
E:E-6131	**** instruction can not be used excluding the 2nd level main program.	Use the functional instruction **** in the LEVEL2 or the subprogram.
E:E-6132	**** instruction can not be used in the range controlled COM instruction.	Do not use functional instruction **** between COM and COME.
E:E-6133	Another CS instruction can not be used in the range of CS instruction.	Use CS and CE in a pair. And don't nest a pair of CS and CE.
E:E-6134	CM instruction must be used between CS and CE instruction.	Use functional instruction CM between CS and CE
E:E-6135	CE instruction must be used in CS instruction and a pair.	Use CS and CE in a pair. And don't nest a pair of CS and CE.
E:E-6136	Use only CM instruction between CS and CE instruction.	Do not use other instructions except the functional instruction CM between CS and CE.
E:E-6150	Ladder diagram has not been modified.	The ladder diagram is not modified, but an attempt was made to update or restore it.
E:E-6152	Ladder data write error.	
E:E-6154	Temporary file load error.	
E:E-6155	Program read error. Not enough program memory.	Allocate conventional memory.
E:E-6156	Program read error. Error status = ****	
E:E-6160	The program is not corresponding	A selected program does not match the program in PMC memory. By specifying, loading, or by storing a correct program, ensure a match with the program in PMC memory.

Error code	Message	Cause/action
E:E-6183	This function is protected.	The online edit/input/output function (sequence program load/store) is protected. Check the keep relay. Display of the data table control screen is protected. Check the keep relay.
E:E-6187	Write protect.	The signal status is write-protected. Check the keep relay.
E:E-6197	INPUT NET TOO LARGE	
E:E-6362	Ladder diagram on the PMC side is being edited now.	
E:E-6701	The type of symbol specified as basic instruction is erroneous.	
E:E-6702	The output prohibition symbol was specified as the coil.	
E:E-6703	The type of symbol specified as functional instruction is erroneous.	
E:E-6704	The output prohibition symbol was specified as the functional instruction.	
E:E-6705	The symbol of incorrect type was specified as the functional instruction.	
E:E-6706	The address of symbols undefined.	
E:E-6707	This functional instruction cannot use the local symbol.	
E:E-6708	The symbol is undefined.	

13.2.6 Message Editing

Error code	Message	Cause/action
G:E-6000	Specify A address.	Specify an A address like A0.0.
G:E-6001	Illegal address data.	The characters you can use for addressing are the letter A, a period (.), and digits 0 to 9.
G:E-6002	Illegal range data.	The maximum allowed A address is exceeded.
G:W-7000	KANJI is not allowed	When the PMC model is PA3, full-size characters cannot be used.

13.2.7 Print

Error code	Message	Cause/action
H:F-2005	Source program has wrong file	
H:F-2008	Cannot open **** file	

13.2.8 Compile

Error code	Message	Cause/action
I:F-2100	Not enough disk space	
I:F-2101	Out of memory	
I:E-3100	**** read error	The source program could not be read.
I:E-3101	**** write error	The results of compilation could not be written.
I:E-3102	**** Source program name illegal.	An invalid source program name was specified.
I:E-3103	**** Source program not found.	The **** source program is not found.
I:E-3104	**** file not found	

Error code	Message	Cause/action
I:E-3105	**** Source program format is different.	The format of the source program is FORMAT-A.
I:E-3106	**** file read error.	
I:E-3107	System parameter read error.	A source file containing system parameter data is missing.
I:E-3108	Title read error.	A source file containing title data is missing.
I:E-3109	I/O module read error.	A source file containing I/O module data is missing.
I:E-3110	Verification error	An entered password does not match the set password.
I:E-3111	This word can not be used as password. Try another word	Try another password.
I:E-3112	Only alphabetical and numerical characters are allowed	A password including other than alphanumeric characters was entered.
I:E-3200	There is an undefined instruction.	An instruction that cannot be handled with a selected type of program is included.
I:E-3201	There is no coil in the functional instruction which needs the coil.	For a function instruction that requires a coil, no coil is set.
I:E-3220	The **** parameter is out of range.	In a parameter of the **** instruction, a numeric value outside the specifiable range is specified.
I:E-3221	Program number is different from program name.	In a parameter of the sub-program start instruction SP, a program number that does not match the file name is specified.
I:E-3222	An illegal program number is specified for the **** instruction.	In a parameter of the **** instruction, a program number outside the specifiable range or an address other than a program number is specified.
I:E-3223	An illegal label number is specified for the **** instruction.	In a parameter of the **** instruction, a label number outside the specifiable range or an address other than a label number is specified.
I:E-3250	There is no LADDER program.	The contents of a ladder program are empty. The END1 or END2 instruction is required.
I:E-3251	The size of LADDER program is too large.	The size of a ladder program exceeds the maximum specifiable size of a selected type of program.
I:E-3252	LADDER program is broken.	An instruction is destroyed and unrecognizable.
I:E-3253	LADDER execution time at the 1st level is too large.	The execution of the first level of the main program takes an excessively long time, so that the ladder cannot be executed. Reduce the first level or increase the value of the system parameter by specifying a ladder execution time ratio.
I:E-3254	The number of division of LADDER exceeds 99.	The number of divisions of the second level of the main program exceeded the maximum allowable value (99), so that the ladder cannot be executed. Reduce the size of the second level or increase the value of the system parameter by specifying a ladder execution time ratio.
I:E-3270	SP instruction can not be used in the main program.	SP is the sub-program start instruction. SP cannot be used with a main program.
I:E-3271	SPE instruction can not be used in the main program.	SPE is the sub-program end instruction. SPE cannot be used with a main program.
I:E-3272	JMPC instruction can not be used in the main program.	JMPC is an instruction for making a jump from a sub-program to the second level of the main program. JMPC cannot be used with a main program.
I:E-3273	CALL instruction can not be used excluding the 2nd level main program.	No sub-program can be called from a level other than the second level of the main program. So, the CALL instruction cannot be used.
I:E-3274	CALLU instruction can not be used excluding the 2nd level main program.	No sub-program can be called from a level other than the second level of the main program. So, the CALLU instruction cannot be used.

Error code	Message	Cause/action
I:E-3290	There is no SP instruction at the top of the subprogram.	Start a sub-program with the SP instruction used to specify the start of a sub-program.
I:E-3291	There is no SPE instruction at the bottom of the subprogram.	End a sub-program with the SPE instruction used to specify the end of a sub-program.
I:E-3292	LADDER program exists beyond SPE instruction.	SPE is the sub-program end instruction. After SPE, no instruction can be specified.
I:E-3293	SP instruction is detected in the subprogram.	SP is the sub-program start instruction. SP cannot be specified in the middle of a sub-program.
I:E-3310	There is no END1 instruction.	At the end of the first level, the END1 instruction is missing.
I:E-3211	There is no END2 instruction.	At the end of the second level, the END2 instruction is missing.
I:E-3312	There is no END3 instruction.	At the end of the third level, the END3 instruction is missing.
I:E-3313	LADDER program exists beyond END1 instruction.	END1 is the end instruction for the first level. After END1, no instruction can be specified.
I:E-3314	LADDER program exists beyond END2 instruction.	END2 is the end instruction for the second level. After END2, no instruction can be specified.
I:E-3315	LADDER program exists beyond END3 instruction.	END3 is the end instruction for the third level. After END3, no instruction can be specified.
I:E-3316	LADDER program exists beyond END instruction.	END is the end instruction for all ladder programs. After END, no instruction can be specified.
I:E-3317	END1 instruction can not be used.	The END1 instruction is used at a level other than the first level.
I:E-3318	END2 instruction can not be used.	The END2 instruction is used at a level other than the second level.
I:E-3319	END3 instruction can not be used.	The END3 instruction is used at a level other than the third level.
I:E-3320	END instruction can not be used.	The END instruction is used at the first level.
I:E-3330	There is no COME instruction.	The COM instruction for starting a COM instruction control range is defined, but the COME instruction for ending the range is not defined.
I:E-3331	CALL instruction can not be used in the range controlled COM instruction.	A sub-program cannot be called from within a COM instruction control range. So, the CALL instruction cannot be used.
I:E-3332	CALLU instruction can not be used in the range controlled COM instruction.	A sub-program cannot be called from within a COM instruction control range. So, the CALLU instruction cannot be used.
I:E-3333	Another COM instruction can not be used in the range controlled COM instruction.	In a COM instruction control range, the COM instruction for starting a control range is defined again.
I:E-3334	COME instruction must be the pair with COM.	If a COM instruction control range is not started, the COME instruction for ending a control range cannot be used.
I:E-3335	COME instruction is detected though the case of the coil number specification.	If the end of a COM instruction control range is defined by specifying the number of coils, the COME instruction for ending a control range cannot be used.
I:E-3340	There is no JMPE instruction.	The JMP instruction for specifying a jump start position is defined, but the JMPE instruction for specifying a jump end position is not.
I:E-3341	Another JMP instruction can not be used in the range of JMP instruction.	Between a JMP instruction for specifying a jump start position and a JMPE instruction for specifying a jump end position, another JMP instruction is defined.
I:E-3342	JMPE instruction must be the pair with JMP.	If the JMP instruction for specifying a jump start position is not defined, the JMPE instruction for specifying a jump end position cannot be used.

Error code	Message	Cause/action
I:E-3343	JMPE instruction is detected though the case of the coil number specification.	If a jump end position is defined by specifying the number of coils, the JMPE instruction for specifying a jump end position cannot be used.
I:E-3350	There is no label of ****.	The label **** for indicating the jump destination of a JMPB instruction cannot be found.
I:E-3351	The label of **** is used twice or more.	At the jump destination of the LBL instruction, the same label number **** is defined. Define a different label number.
I:E-3352	Too many labels.	The total number of LBL instruction jump destinations defined exceeded the maximum allocable value of a selected type of program. Reduce the number of jump destinations defined.
I:E-3353	The destination of JMPB instruction is beyond COM/COME instruction.	The JMPB instruction cannot be used to make a jump from within a COM instruction control range to an external point, or from a point outside a COM instruction control range to a point within the range. The JMPB instruction can only be used to make a jump from one position to another both within a COM instruction control range or outside a COM instruction control range.
I:E-3400	There is an undefined instruction.	A step sequence program includes an instruction that cannot be handled by a selected type of program, or a destroyed instruction.
I:E-3420	Program number is different from program name.	In a parameter of program start instruction SP, a program number that does not match the file name is specified.
I:E-3421	An illegal step number is specified for the **** instruction.	In the **** instruction, a step number outside the specifiable range or an address other than a step number is specified.
I:E-3422	An illegal program number is specified for the **** instruction.	In the **** instruction, a program number outside the specifiable range or an address other than a program number is specified.
I:E-3423	An illegal label number is specified for the **** instruction.	In the **** instruction, a label number outside the specifiable range or an address other than a label number is specified.
I:E-3440	There is no SP instruction at the top of the subprogram.	A sub-program must start with the SP instruction for specifying the start of a sub-program.
I:E-3441	There is no SPE instruction at the bottom of the subprogram.	A sub-program must end with the SPE instruction for specifying the end of a sub-program.
I:E-3442	Step sequence program exists beyond SPE instruction.	SPE is the sub-program end instruction. After SPE, no instruction can be specified.
I:E-3443	SP instruction is detected in the subprogram.	SP is the sub-program start instruction. SP cannot be specified within a sub-program.
I:E-3460	The label **** is assigned for two or more step programs.	At a jump destination, the same label number **** is defined. Define a different label number.
I:E-3461	Too many labels.	The total number of jump destinations defined exceeded the maximum allowable value for step sequence editing. Reduce the number of jump destinations defined.
I:E-3462	DSTEP instruction without DLBL.	The label representing the jump destination of a DSTEP instruction cannot be found.
I:E-3480	The step number **** is assigned for two or more step programs.	For a different step, the same step number **** is used. Define a different step number.
I:E-3570	The size of the message data is too large.	The total number of message data characters exceeded the maximum allowable value of a selected type of program. Reduce the total number of characters.

Error code	Message	Cause/action
I:E-3600	Data too large.(LADDER + step sequence)	The total size of the ladders and step sequences exceeded the maximum allowable value of a selected type of program. Reduce the size of the ladders/step sequences.
I:E-3601	Data too large.(message + symbol + comment + LADDER + step sequence)	The total size of the messages, symbols, comments, ladders, and step sequences exceeded the maximum allowable value of a selected type of program. Reduce the amount of data.
I:E-3620	There is no subprogram ****.	Because the sub-program file with number **** is not included in the selected program, the file cannot be called. Create a sub-program with number ****.
I:E-3640	LADDER/step sequence program exists beyond END instruction.	A sub-program exists, but the END instruction is specified at the end of level 2.
		The END instruction is specified at the end of a sub-program, but a sub-program with a greater program number exists.
I:E-3650	There is no label of ****.	Label **** representing the jump destination of the JMPC instruction cannot be found.
I:E-3651	The label of **** is used twice or more.	In the main program, the same label number **** is defined as the jump destination of the LBL instruction. Define a different label number.
I:E-3652	Too many labels.	The total number of LBL instruction jump destinations defined in the main program exceeded the maximum allowable value of a selected type of program. Reduce the number of jump destinations defined.
I:E-3653	The label of **** to refer exists in another level.	JMPC is the instruction for making a jump from a sub-program to the second level of the main program. Define the jump destination label **** at the second level.
I:E-3654	The label of **** exists in the range of the COM instruction.	The jump destination label **** of the JMPC instruction is specified within a COM instruction control range. Specify the label **** outside the control range.
I: E-6270	CS instruction can not be used excluding the 2nd level main program.	Use functional instruction CS in the LEVEL2 or the subprogram.
I: E-6271	CM instruction can not be used excluding the 2nd level main program.	Use functional instruction CM in the LEVEL2 or the subprogram.
I: E-6272	CE instruction can not be used excluding the 2nd level main program.	Use functional instruction CE in the LEVEL2 or the subprogram.
I: E-6330	CS instruction can not be used in the range controlled COM instruction.	Do not use functional instruction CS between COM and COME.
I: E-6331	CM instruction can not be used in the range controlled COM instruction.	Do not use functional instruction CM between COM and COME.
I: E-6332	CE instruction can not be used in the range controlled COM instruction.	Do not use functional instruction CE between COM and COME.
I: E-6360	There is no CE instruction.	Although the functional instruction CS is used, there is no functional instruction CE that means the end.
I: E-6361	Another CS instruction can not be used in the range of CS instruction.	Use CS and CE in a pair. And don't nest a pair of CS and CE.
I: E-6362	CM instruction must be used between CS and CE instruction.	Use functional instruction CM between CS and CE
I: E-6363	CE instruction must be used in CS instruction and a pair.	Use CS and CE in a pair. And don't nest a pair of CS and CE.
I: E-6365	Use only CM instruction between CS and CE instruction.	Do not use other instructions except the functional instruction CM between CS and CE.
I: E-6751	File I/O error.	

13.ERROR MESSAGES

B-66234EN/05

Error code	Message	Cause/action
I: E-6752	The range of the assignment is illegal.	
I: E-6753	The range of assignment overlaps.	
I: E-6754	The allocation range is not enough.	
I:W-4100	The title data which could not be display on the CNC was replaced with space code.	Title data includes characters such as kana characters. Those characters are replaced with blank characters.
I:W-4101	Illegal OP.PANEL(PARAMETER). Proceed to compile using 'NO'	A system parameter is set to use the FS0 operator's panel, but addresses (such as a key input address and LED output address) are not set. Compilation is performed, assuming that the FS0 operator's panel is not used.
I:W-4102	Editing sub-program has not completed.	A sub-program is being edited. Complete the editing.
I:W-4103	Multiple sub-programs with same number exist.	A sub-program with the same number exists (for example, P1.#LA and P1.#SS). The ladder program is compiled first (P1.#.LA, for example).
I:W-4104	The source-program is FORMAT-B. This parameter is ignored: SYMBOL/COMMENT	FORMAT-B outputs symbols/comments at all times.
I:W-4105	The source-program is FORMAT-B. This parameter is ignored: NET COMMENT	FORMAT-B data does not include a net comment. Setting this item has no effect.
I:W-4200	There is no LADDER program.	A ladder program is empty. The ladder program is not output to a memory card format file.
I:W-4201	LADDER execution time at the 1st level is too large.	Reduce the first level, or increase the value of the system parameter by specifying a ladder execution time ratio.
I:W-4202	The coil number specification of COM instruction is not allowed.	The end of a COM instruction control range cannot be defined using the number of coils. The specification of the number of coils is ignored, and the end of a COM instruction control range is determined based on the COME instruction.
I:W-4203	The coil number specification of JMP instruction is not allowed.	The end position of a jump cannot be defined using the number of coils. The specification of the number of coils is ignored, and the end position is determined based on the JMPE instruction.
I:W-4204	Unused NET COMMENT pointer found.	A ladder program includes a pointer to a lost net comment character string. The pointer is not output to a memory card format file.
I:W-4400	There is no step sequence program.	A step sequence program is empty. The step sequence program is not output to a memory card format file.
I:W-4500	The symbol data which could not be display on the CNC was replaced with space code.	Symbol data includes special characters that cannot be displayed by the CNC. Those characters only are replaced with blank characters.
I:W-4501	The comment data which could not be display on the CNC was replaced with space code.	Comment data includes special characters that cannot be displayed by the CNC. Those characters only are replaced with blank characters.
I:W-4502	Comment data size exceeds 64KB. Symbol/comment data is not converted to the Memory card format file.	The total number of comment data characters exceeded 65535. None of the symbols/comment data is output to a memory card format file.
I:W-4503	The character * in the comment may not be displayed on the CNC.	The comment uses a character code not available to the CNC and, therefore, may not be displayed.
I:W-4504	Double-sized space character in comment was changed to two single-sized spaces.	The comments uses a double-byte space character, and the character is replaced by two single-byte space characters.
I:W-4505	Too long strings for symbol data.	A symbol that exceeds the character length limit (six characters) is found, and is deleted. (The comment remains valid.)

Error code	Message	Cause/action
I:W-4570	The message data which could not be display on the CNC was replaced with space code.	Message data includes special characters that cannot be displayed by the CNC. Those characters only were replaced with blank characters.
I:W-4600	Unreferenced subprogram ****.	The **** sub-program is not called from any program, but is output to a memory card format file.
I:W-4601	\$ number * is duplicated.	
I:W-6500	Address is illegal.	The **** sub-program is not called from any program, but is output to a memory card format file.
I:W-7500	The original symbol may be unable to display by decompiling.	
I: W-7751	Assignment was started from address boundary.	

13.2.9 Decompile

Error code	Message	Cause/action
J:F-2100	Function code error DATA:***** SYSTEM:*****	There is a mismatch between the function codes in a memory card format file and the function codes of the system. DATA is for the file side, and DATA is for the system side. Install the correct system.
J:F-2101	PMC series is different from **** Memory card format file.	The type of memory card format file **** differs from the type of a selected program. Select a correct program.
J:F-2102	**** Memory card format file not found.	The specified memory card format file **** is not found. Prepare a file.
J:F-2103	Mismatched password.	Execution is rejected because the password is incorrect. Enter the correct password.
J:F-2104	**** Memory card format file read error.	The memory card format file **** could not be read. The file is invalid.
J:F-2105	**** source program write error.	The source program **** could not be written.
J:E-3100	There is an undefined instruction.	An instruction that cannot be handled by a selected type of program, or a destroyed instruction is included.
J:E-3101	There is no SPE instruction at the bottom of the subprogram.	A sub-program in a selected program does not end with the SPE instruction.
J: E-3200	The number of symbol data in source program exceeds the limit.	The number of symbol data items in a selected program exceeded the maximum allowable value defined with the system. Reduce the number of symbol data items.
J:E-3300	ID code (I/O module) error.(address ****)	The ID code defined at address **** in the I/O module data cannot be recognized correctly. Prepare a correct memory card format file.
J:W-4100	The size of LADDER program is too large.	The number of steps of a sub-program in a ladder program exceeded the maximum allowable value of a selected type of program, but the sub-program is output to the source program. Make corrections by ladder editing as required.
J:W-4101	**** unused NET COMMENT pointer found.	**** net comment pointers not corresponding to net comment character strings were detected. The net comment pointers are not output to the source program. Make corrections by ladder editing as required.
J:W-4102	**** unused NET COMMENT strings found.	**** net comment character strings not corresponding to net comment pointers were detected. The net comment character strings are deleted. Make corrections by ladder editing as required.

Error code	Message	Cause/action
J:W-4103	**** duplicated NET COMMENT pointer found.	**** duplicate net comment pointers were detected. Character strings are copied so that the same net comment character string corresponds to the same net comment pointer.
J:W-4104	The step number of **** is used twice or more.	The same step number **** is used for different steps. Make corrections by step sequence editing.
J:W-4105	Some sub-programs are protected. These sub-programs have not been decompiled.	
J: W-4200	The number of symbol data exceeds the limit.(address, symbol)	During symbol data merge processing, the total number of data items at address ****/symbol **** exceeded the maximum allowable value defined with the system. Data beyond the symbol data is not output to the source program.
J:W-4201	**** symbol data at duplicated address found.	**** duplicate symbol data items defined for the same address were detected. Either source data or memory card data is valid according to the setting of the symbol merge option.
J:W-4202	Same symbol exists.(address **** symbol ****)	The symbol character string defined in the symbol data at address ****/symbol **** is already defined at another address. The symbol data is not output to the source program.
J: W-4203	Illegal symbol.(address, symbol)	The symbol data at address ****/symbol **** is determined to be invalid by a symbol character string check based on the IEC standard. The symbol data is not output to the source program. If the check option in the %%%FLSET.CNF setting file is deselected, the symbol data is output to the source program.
J: W-4204	Symbol data address illegal.(symbol)	The address in the symbol data containing symbol **** cannot be recognized correctly. The symbol data is not output to the source program.
J:W-4300	Illegal operator panel (system parameter). Proceed to decompile using 'NO'.	The specification of an operator's panel in the system parameter data is invalid. Execution is continued, assuming that the specification of the operator's panel is invalid.
J:W-4301	This Memory card format file is not for expanded R/D address.	If the PMC version of PMC-RC is less than 3, R/D extended addresses are not supported. Change the PMC version by system parameter editing.
J:W-4800	**** Memory card format file illegal.	The header section of the memory card format file **** is invalid, but execution is continued.
J:W-4900	'OPTION' read failed.	The default setting was used. Settings in the option file of a selected program cannot be read. Prepare a file, or correct the settings. Execution is made possible by option resetting.
J:W-4901	'%%FLSET.CNF' read failed.	Symbol characters are not checked. Settings in the %%%FLSET.CNF file cannot be read. Prepare a file, or correct the settings. Execution is possible if symbol characters are not checked.
J: W-7200	Prog. is out of range.(Prog.)	
J: W-7201	The symbol does not exist.(Address)	
J: W-7202	The symbol has exceeded the limitation length of characters.(Prog., Symbol)	
J: W-7203	The symbol used the limitation character.(Prog., Symbol)	

Error code	Message	Cause/action
J: W-7204	The paragraph of comment exceeded the number of limitations.(Prog.:\$, Symbol:\$)	
J: W-7205	The comment has exceeded the limitation length of characters.(Comment)	
J: W-7206	The comment used the limitation character.(Comment)	
J: W-7210	Address and type does not exist.	
J: W-7211	This symbol cannot be defined as the local symbol.(Prog., Symbol, Address)	
J: W-7212	The symbol of the same name as the already inputted global symbol cannot be inputted.(Prog., Symbol)"	
J: W-7213	The symbol of the same name as the already inputted local symbol cannot be inputted.(Prog., symbol)	
J: W-7214	Prog. is illegal.(Prog.)	
J: W-7215	Attribute is illegal.(Attribute)	
J: W-7216	Address and Attribute are contradictory.(Address, Attribute)	
J: W-7217	Address and Type are contradictory.(Address, Type)	
J: W-7218	Type does not exist.	
J: W-7219	Type is illegal.(Type)	

13.2.10 Mnemonic Conversion

Error code	Message	Cause/action
K:F-2000	Insufficient memory.	
K:F-2001	Insufficient disk space.	
K:F-2006	Not found **** file.	
K:F-2100	Not found * file.	
K:F-2101	Set-up file broken.	
K:F-2102	Illegal option(s).	
K:F-2103	Insufficient parameter(s).	System parameter /function instruction data is insufficient.
K:F-2104	Too many parameters.	Too many parameters are specified in a function instruction.
K:F-2105	Illegal Option-specified file.	
K:F-2106	Illegal Idcode.	
K:F-2107	Expected terminator.	
K:F-2108	PMC series is different from Source-program.	
K:F-2109	Expected Idcode.	
K:F-2110	Illegal parameter(s).	
K:F-2111	Create temporary file(s) in current directory.	
K:F-2112	Not specified environmental variable 'TMP'.	
K:F-2113	Illegal name of Set-up file.	
K:F-2114	Not found Set-up file.	
K:F-2115	Expected '/PC' option.	
K:F-2116	**** executable file not found.	
K:F-2117	Input data illegal.	
K:F-5001	Prog. is illegal.(Prog.)	
K:F-5002	Prog. is out of range.(Prog.)	

13.ERROR MESSAGES

B-66234EN/05

Error code	Message	Cause/action
K:E-3100	**** file cannot execute.	
	The file cannot be executed.	
K:E-3101	The data of **** is broken.	
	* Symbol & Comment data broken.	
K:E-3102	Cannot be handle data type '%@2-C'.	When the format of %%%FLSET.CNF is FORMAT-A/B, the mnemonic of the extended symbol %@2-C was converted.
K:E-3103	Cannot convert files of the PMC series set up the system.	
	The model set with the system cannot be converted.	
K:E-3104	Cannot overwrite existing data.	
K:E-3105	Cannot specify bit address of parameter.	A bit address was specified in a byte address parameter of a function instruction.
K:E-3106	Cannot specify byte address on basic instruction.	A byte address was specified in a basic instruction.
K:E-3107	Cannot specify output module at input address.	An output module is specified at the input address of I/O module data.
K:E-3108	Cannot specify input module at output address.	An input module is specified at the output address of I/O module data.
K:E-3109	Cannot specify the address prohibited using as parameter.	A parameter prohibition address was specified in the address parameter of a function instruction.
K:E-3110	Cannot specify the bit address.	
K:E-3111	Cannot specify the byte address.	
K:E-3112	Cannot specify the input address.	An output prohibition address was specified in the output address parameter of a function instruction.
K:E-3113	Cannot specify the input address with coil.	An output prohibition address was specified for a coil.
K:E-3114	Cannot specify the odd address.	An odd-numbered prohibition address was specified as an odd-numbered address.
K:E-3117	Expected a multiple of 2.	A system parameter includes a numeric value that is not a multiple of 2.
K:E-3118	Expected a multiple of 5.	A system parameter includes a numeric value that is not a multiple of 5.
K:E-3119	Expected address.	A basic instruction has no address.
K:E-3120	Expected function number.	
K:E-3121	Expected parameter(s).	A function instruction has no parameter.
K:E-3122	The identification code is not found in mnemonic file.	
K:E-3123	Illegal address.	An invalid address was specified as a symbol/ comment data/message setting address.
K:E-3124	Illegal address in data table.	An invalid address was specified in the data table of a function instruction.
K:E-3125	Illegal address of parameter.	An invalid address was specified in the address parameter of a function instruction.
K:E-3126	Illegal character(s).	Invalid character data is contained in a system parameter, title data, symbol/comment data, or message data.
K:E-3127	Illegal Source-program name.	
	The specified source program name is illegal.	
K:E-3128	The specified mnemonic file name is illegal.	
	Illegal Mnemonic file name.	
K:E-3129	Illegal parameter number.	An invalid data number was specified in a system parameter.
	Illegal title number.	
K:E-3130	Illegal value of parameter.	An invalid data number was specified as a data identifier.

Error code	Message	Cause/action
K:E-3131	Illegal value.	Invalid numeric data was specified in a system parameter.
K:E-3132	Illegal value in base data.	An invalid value was specified for the base data of I/O module data.
K:E-3133	Illegal value in group data.	An invalid value was specified for the group data of I/O module data.
K:E-3134	Illegal value in slot data.	An invalid value was specified for the slot data of I/O module data.
K:E-3135	Illegal value of parameter.	An invalid numeric value was specified in the data table of a function instruction.
K:E-3136	Include KANA or KANJI character(s).	
K:E-3137	Input mnemonic file name	
K:E-3138	Input the source program name.	
K:E-3139	The conversion data type number is illegal.	
	The data type number is illegal	
	Invalid a number of convert data.	
K:E-3140	Invalid function's name.	An invalid function instruction name was specified.
K:E-3141	Invalid function number.	
K:E-3142	Invalid module name.	The module name of I/O module data is invalid.
K:E-3143	Return status from SPAWN is E2BIG(=7).	
K:E-3144	The model of the specified source program is illegal.	
	Invalid PMC series of specified Source-program.	
K:E-3145	Invalid qualifier.	An invalid character follows a system parameter, title data, symbol/comment data, ladder, or I/O module data.
K:E-3146	There is no option by which **** file is specified.	
	Lack of **** file	
K:E-3147	Message data too large.	
K:E-3148	Specified Mnemonic file is not found.	
	Mnemonic file not found.	
K:E-3149	Not enough parameter(s)	System parameter /function instruction parameters are insufficient.
K:E-3150	Not found base data.	The base data of I/O module data is missing.
K:E-3151	Not found group data.	The group data of I/O module data is missing.
K:E-3152	Not found module name.	The module name of I/O module data is missing.
K:E-3153	Not found slot data	The slot data of I/O module data is missing.
K:E-3154	Not found **** Process interface file.	
K:E-3155	Not found **** Source-program management file.	
K:E-3156	Not found **** SUB program file.	
K:E-3157	Out of address limits.	The address of mnemonic data/I/O module data was specified.
K:E-3158	Out of address limits in data table.	An address outside the specifiable range was specified in the data table of a function instruction.
K:E-3159	Out of address limits of address.	An address outside the specifiable range was specified as a message setting address.
K:E-3160	Out of address limits of parameter	An address outside the specifiable range was specified in a parameter of a function instruction.
K:E-3161	Out of parameter value.	A numeric value outside the specifiable range was specified in a parameter of a function instruction.

Error code	Message	Cause/action
K:E-3162	Out of value.	A numeric value outside the specifiable range was specified in a system parameter.
K:E-3163	Out of value in base data.	A value outside the specifiable range was specified for the base data of I/O module data.
	Not found slot data.	
K:E-3164	Out of value in data table.	A numeric value outside the specifiable range was specified in the data table of a function instruction.
K:E-3165	Out of value in group data.	A value outside the specifiable range was specified for the group data of I/O module data.
K:E-3166	Out of value in slot data.	A value outside the specifiable range was specified for the slot data of I/O module data.
K:E-3167	Please shorten file name.	
K:E-3168	Process error	
K:E-3172	Specified source program is not found.	
	Source-program not found.	
K:E-3173	Specified source program is not found.	
	The specified conversion data is not found.	
K:E-3174	Specify the value(Slot) except 0 at I/O UNIT-B*.	
K:E-3176	Symbol data count over.	
K:E-3177	Symbol data not found.	Comment data is set, but symbol data is not.
K:E-3178	Symbol or comment data not found.	Data containing a symbol or comment only was converted to an address.
K:E-3179	The same group base and slot are already specified.	In I/O module data, the same number is specified for group, base, and slot data.
K:E-3180	Too large of total comment data.	
K:E-3181	Too long strings.	The length of a system parameter, message data, or title data exceeded the maximum allowable value.
K:E-3187	Too many characters in 1 line.	The number of characters on one line of mnemonic data, a mnemonic, or I/O module data in a system parameter, message data, title data, or symbol/comment exceeded the maximum allowable value.
K:E-3188	Too many parameters.	Too many parameters are set for a function instruction.
K:E-3189	Total value of base and slot is over.	The total of the base and slot values of the I/O module data exceeded the default.
K:E-3190	Undefined instruction.	Data includes an undefined instruction.
K:E-3191	Unexpected address.	An address was specified where no address is required.
K:E-3192	Unexpected parameter(s).	Parameters were specified in a function instruction that requires no parameters.
K:E-3193	Unknown data number.	A nonexistent data number was specified as a system parameter/data identifier.
K:E-3194	Data entry error.	Symbol/comment data could not be registered.
K:E-3195	Include KANA or KANJI character(s) in symbol data.	Full-size characters cannot be used for symbol data.
K:E-3196	Include KANA or KANJI character(s).	
K: E-3197	Column number overlaps in option setting.	Confirm the contents of the option setting of "%@3-E".
K: E-3198	The range of the assignment is illegal.	Confirm the range of automatic address assignment.
K: E-3199	The range of assignment overlaps.	Confirm whether the range of automatic address assignment overlaps others.
K: E-3200	The allocation range is not enough.	Increase the range of automatic address assignment.
K: E-3201	The label number exceeded the limit.	The label is not assigned because limitation of the number of labels was exceeded.

Error code	Message	Cause/action
K: E-3202	Automatic assignment of the address was unsuccessful.	Compile the ladder and perform automatic address assignment.
K:E-6001	Cannot be handle data type '%@2-D'.	
K:E-6101	The address of symbol is undefined.	
K:E-6201	The limitation character is used for the symbol.	
K:E-6202	This functional instruction cannot use the local symbol.	
K:E-6301	The address of symbol is undefined.	
K:W-4100	Comment data not found.	Data consisting of symbols only was converted to an address.
K:W-4101	Data not found.	System parameters, message data, title data, symbols/comments, and I/O module data are not found.
K:W-4102	Deleted KANJI characters.	
K:W-4103	Expected control condition(s).	No control condition is set for a function instruction.
K:W-4104	Illegal characters are specified at ****.	Invalid data was specified in ****.
K:W-4105	Illegal OP.PANEL(PARAMETER). Proceed to convert with using 'NO'.	The system parameter OP.PANEL (parameter) is invalid. Conversion is performed assuming "NO."
K:W-4106	Illegal symbol.	The symbol data does not satisfy the standard (check level-1). (FORMAT-C)
K:W-4108	Include KANA or KANJI character(s) in comment data.	Comment data including full-size characters was converted without selecting the full-size character conversion option (J option).
K:W-4109	Logical operated with unused register(s).	An operation was performed with a register not entered in the ladder data.
K:W-4110	Logical product remains in register(s).	A register was not output to ladder data.
K:W-4111	Message data include KANA OR KANJI characters at ****.	Message data **** includes full-size/half-size katakana characters.
K:W-4112	Not enough control condition(s).	Not all necessary control conditions are set for a function instruction.
K:W-4113	Not found data at **** address.	At address ****, no message is defined.
K:W-4114	Not found parameter numbered ****. Not found title numbered \$.	
K:W-4116	Not found **** PMC-OS file..	
K:W-4117	Not used net comment pointer exist. \$	
K:W-4118	Output unused register(s).	
K:W-4119	Overwrote existing data.	
K:W-4120	Invalid qualifier.	An invalid character follows the end ID code (%) of each data item (system parameter, message data, title data, ladder, symbol/comment, and I/O module data).
K:W-4121	Registers overflow.	
K:W-4122	Some garbage data are found at end of ladder data.	Upon conversion to FORMAT-B, data that does not belong to the first to third levels or any sub-programs was found. This message is output when data is found after the last SPE instruction.
K:W-4123	Specify same group base and slot.	In the I/O module data, the same number is specified for group, base, and slot data.
K:W-4124	Specify same number(Group) at I/O UNIT-B as I/O UNIT-A.	
K:W-4125	Specify the value(Base) except 0 at I/O UNIT-B.	

Error code	Message	Cause/action
K:W-4126	The following data of **** were deleted because of exceeding the limit.	
K:W-4127	Too many control conditions.	Too many control conditions are set for a function instruction.
K:W-4128	Unexpected coil(s).	Coils were specified for a function instruction that requires no coils.
K:W-4129	Unexpected control condition(s).	A basic instruction was specified for a function instruction that requires no control condition.
K:W-4130	Redefinition of address data.	A symbol definition is made at more than one location for the same address. If the start ID code of symbol data is %@2, no duplicate definition is allowed. The definition or definitions made later are ignored.
	Illegal net comment pointer. ****	
K:W-4131	Redefinition of symbol data.	The same symbol data was specified for different addresses. The symbol data defined later is replaced with blank characters.
K:W-4132	Too long strings for symbol data.	FORMAT-A/B allows up to 6 characters. FORMAT-C allows up to 16 characters. Symbol data is replaced with blank characters.
K:W-4133	Too long strings for comment data.	A maximum of 30 characters can be specified. Comment data is replaced with blank characters.
K:W-4134	symbol data already exist.	For one address, a different symbol is specified at more than one location. (With FORMAT-C, the same symbol may be specified at more than one location.) The symbol data specified later is replaced with blank characters.
K:W-4135	relay comment data already exist.	For a relay comment at one address, a different character string is specified at more than one location. (With FORMAT-C, the same character string may be specified at more than one location.) The relay comment data specified later is replaced with blank characters.
K:W-4136	coil comment data already exist.	For a coil comment at one address, a different character string is specified at more than one location. (With FORMAT-C, the same character string may be specified at more than one location.) The coil comment data specified later is replaced with blank characters.
K:W-4137	comment title data already exist.	For a comment title at one address, a different character string is specified at more than one location. (With FORMAT-C, the same character string may be specified at more than one location.) The comment title data specified later is deleted.
K:W-4138	Too long strings for relay comment data.	The character string of a relay comment is longer than 16 characters. With FORMAT-C only, relay comment data is replaced with blank characters.
K:W-4139	Too long strings for coil comment data.	The character string of a coil comment is longer than 30 characters. With FORMAT-C only, coil comment data is replaced with blank characters.
K:W-4140	Too long strings for comment title data.	The character string of a comment title is longer than 30 characters. With FORMAT-C only, comment title data is replaced with blank characters.

Error code	Message	Cause/action
K:W-4143	The symbol replaced by the specified character was not output because it was duplication definition.	
K: W-7000	The space code of the symbol data was replaced with the specification character.	The white-space character of a symbol was replaced with the specified character.
K:W-7001	This symbol cannot be defined as the local symbol.(Symbol, Address)	
K:W-7002	The space code exists in the symbol data.	
K:W-7003	The symbol of the same name as the already inputted local symbol cannot be inputted.(Prog., symbol)	
K:W-7004	Too long strings for third comment data.	
K:W-7005	Too long strings for fourth comment data.	
K:W-7006	Third comment data already exist.	
K:W-7007	Fourth comment data already exist..	
K:W-7008	It skipped because there was no symbol.	
K:W-7009	The symbol that used the limitation character was skipped.(Prog., Symbol)	
K:W-7010	The symbol that used the limitation character was replaced.(Prog., Symbol)	
K:W-7011	Address and Type does not exist.	
K:W-7012	Type is illegal.(Type)	
K:W-7013	Address and Type are contradictory.(Address, Type)	
K:W-7014	Address or Type is illegal.(Address, Type)"	
K:W-7015	Type was changed to LABEL.	
K:W-7016	Type cannot be changed.	
K:W-7017	Type was changed to PROG.	
K: W-7018	Address is illegal.	Confirm the address and change into the right address.
K: W-7019	Address and Symbol type is undefined.	Confirm the type of the address and the symbol and change into the right address or the right type.
K: W-7020	The quotation mark is not a pair.	Confirm the quotation mark (the double quotation mark or the single quotation mark).
K: W-7021	Address is undefined.	Add the address.
K:W-7201	The undefined symbol is used.	

13.2.11 Input/Output

Error code	Message	Cause/action
L:E-6000	I/O Error.	Recheck the setting of MONIT on the PMC.
L:E-6001	The system failed in making the thread	
L:E-6002	PMC parameter file read error	
L:E-6003	PMC parameter file write error	
L:E-6004	PMC parameter file write error Insufficient disk space	
L:E-6005	This file format is not PMC parameter file format	
L:E-6006	Can not load PMC parameter from PMC side(Not EDIT mode)	
L:E-6007	Can not store PMC parameter to PMC side(Not emergency stop nor PWE = 1)	

13.2.12 Online

Error code	Message	Cause/action
N:E-3001	Flash ROM Write error	The F-ROM is abnormal. Replace the F-ROM. Contact your FANUC service center.
N:E-3002	Flash ROM Read error	
N:E-3003	Flash ROM Erase error	The F-ROM is abnormal. Replace the F-ROM. Contact your FANUC service center.
N:E-3004	Flash ROM Area error	
N:E-3005	Flash ROM Program nothing	
N:E-3006	Flash ROM Size error	A sequence program is larger than the F-ROM. Increase the size of the F-ROM. Try the CONDENCE function, which is an offline function.
N:E-3007	Flash ROM Not EMG stop	The CNC is not placed in the emergency stop state. Place the CNC in the emergency stop state.
N:E-3008	Flash ROM Program data error	A sequence program on the PMC is destroyed. Reenter the sequence program.
N:E-3009	Flash ROM Access request error	
N:E-3011	User C program error occurs on PMC.	
N:E-3012	Flash ROM Another used	
N:E-3013	Flash ROM Command error	
N:E-3014	Flash ROM No space	
N:E-3015	Flash ROM File error	
N:E-3016	Flash ROM File not match	
N:E-3017	Flash ROM Un-known F-ROM	
N:E-3018	Flash ROM I/O error	
N:E-3019	Flash ROM Undefine error code	
N:E-3300	Signal trigger unavailable	The user switched from online editing to the signal trigger stop function.
N:E-3302	Reject Signal trigger	The user switched to online editing during signal trigger execution.
N:E-3307	Cannot be changed Signal trigger is executing	The user attempted to modify parameter settings during signal trigger execution.
N:E-3390	Program is running	
N:E-3410	Function param is out of range	
N:E-6000	Signal Analysis function is not supported	The PMC is of a type that does not support the signal analysis function.
N:E-6001	Signal Trace function is running	During signal trace function execution, the signal analysis function cannot be executed.
N:E-6002	Address Error	A specified address is invalid.
N:E-6003	No Trigger Address	When the condition is <Trigger-ON> or <Trigger-OFF>, set a trigger address.
N:E-6004	[About]/[Before] is illegal on [Start] selected	When the condition is <Start>, <About> and <Before> cannot be selected as a trigger mode.
N:E-6005	No Signal Address	No sampling address is set.
N:E-6006	Sampling Time Error:	An invalid sampling time is set.
N:E-6041	The communication to PMC is not ready	The connection with the NC is disconnected.

APPENDIX

A

CABLE FOR DATA TRANSFER

When data is transferred from the personal computer (PC) to the CNC, the cable shown below is used.

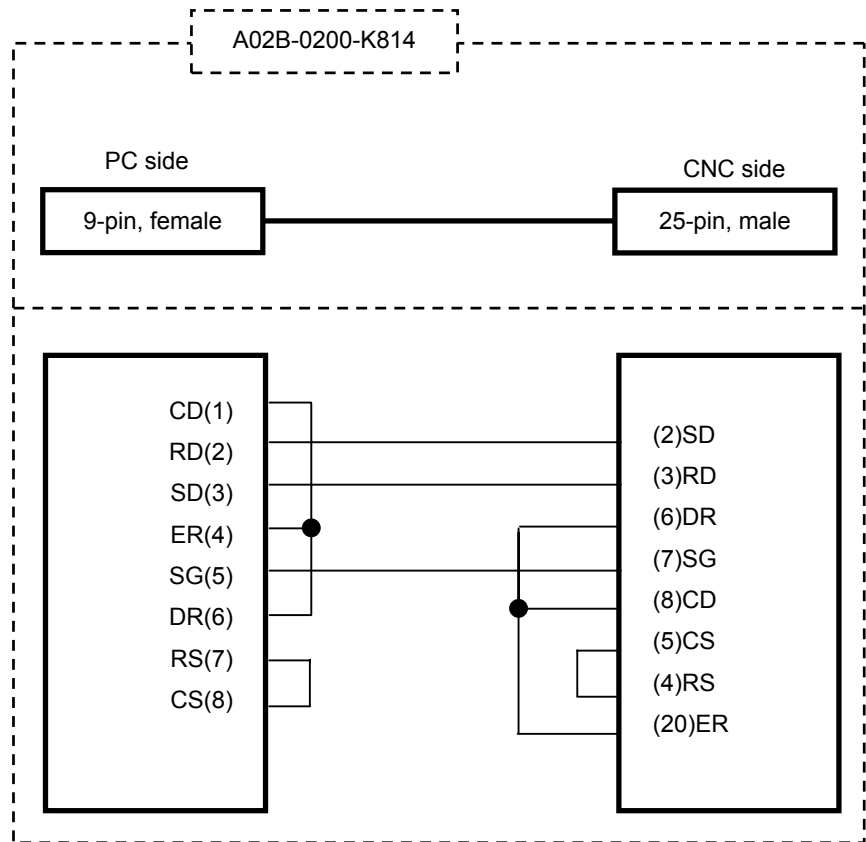

B

CONVERSION USING A SIGNAL ADDRESS CONVERTER

Table B

Converter file name	Applicable function	Reference document
FS0T_CNV.SYM	PMC-L/M/M(MMC) (FS0-T) → PMC-SA1/SA3/SB3/SC3/SB4/SC4/SB5/SB6 (FS16/18/20-T)	FANUC PMC-MODEL PA1/PA3/SA1/SA2/SA3/SA5/SB/SB2/SB3/SB4/SB5/SB6/SB7/SC/SC3/SC4/NB/NB2/NB6 Programming Manual (Ladder Language) B-61863E
FS0M_CNV.SYM	PMC-L/M/M(MMC) (FS0-M) → PMC-SA1/SA3/SB3/SC3/SB4/SC4/SB5/SB6 (FS16/18/20-M)	
PM-C_CNV.SYM	PMC-P (Power Mate-MODEL C) → PMC-PA3 (Power Mate-MODEL D/F/H)	

The converter files are stored in the subdirectory \APPENDIX of the system floppy (Vol. 5).

Example of operation: PMC-P → PMC-PA3

- <1> By using FANUC LADDER, convert a program of the PMC-P model (conversion source) to a mnemonic file. (A in the figure below)
- <2> By using FANUC LADDER-III, create a program of the PMC-PA3 model (conversion destination).
- <3> Convert the program of <2> to mnemonics. (B in the figure below)
- <4> Start a text editor commercially available, then open the mnemonic file (conversion destination) created in <3>.
- <5> Replace the symbol data of the mnemonic file (conversion destination) with the converter file. (C in the figure below)
- <6> Replace the ladder data of the mnemonic file (conversion destination) with the ladder data of the mnemonic file (conversion source) created in <1>. (D in the figure below)
- <7> Close the mnemonic file (conversion destination) on the text editor.
- <8> By using FANUC LADDER-III, convert the mnemonic file (conversion destination) of <7> to a source program (with the program created in <2> left open).
- <9> Delete all symbol comment data.

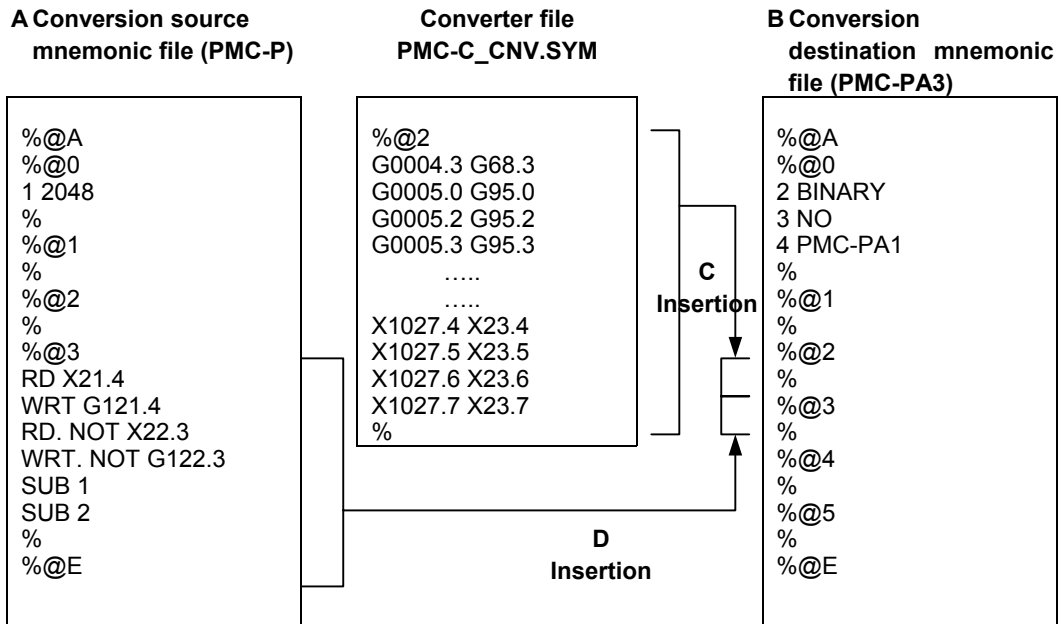

C

LANGUAGE PROGRAM LINK FUNCTION

This function is used to unite a load module created in C language with a memory card file created on FANUC LADDER-III or loaded from the PMC.

1. Select [File] - [Open Program], and open the program with which you want to unite a load module.
2. Select [Tool] - [Link of language programs...].

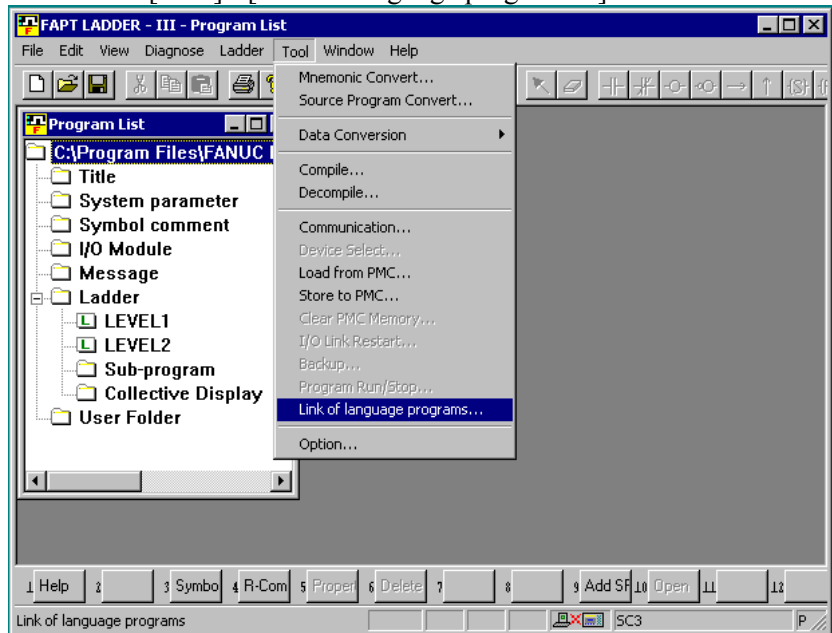

3. The [Link of language programs] dialog box appears.

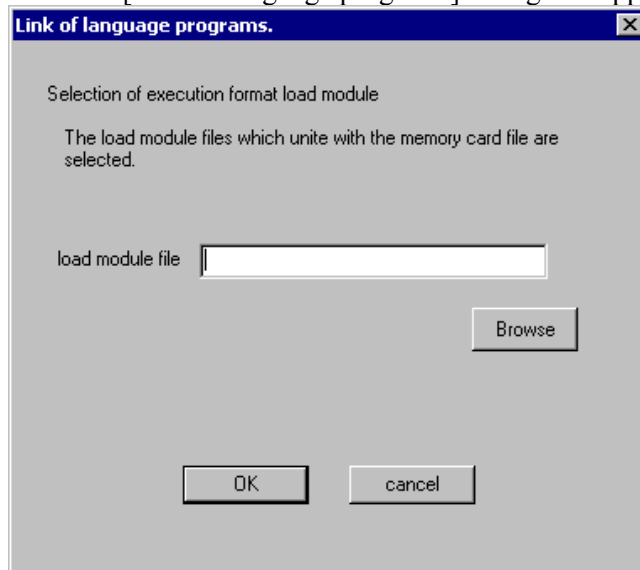

4. Select the load module file you want to unite.
5. Click the "OK" button to unite the load module with the program.

NOTE

- 1 If not using C language functions, you need not unite programs.
- 2 This function is available to models PMC-SC3/SC4/SC4 (STEP SEQ.)/QC/NB/NB2.

D

MULTI-LANGUAGE PMC MESSAGE CREATION TOOL

This is a PC software tool for creating a memory card format file only for PMC message from source files, which is same as a mnemonic file format, for multi-language PMC message on FANUC LADDER-III, or for creating a source file from the memory card format file.

To enhance message display using DISPB functional instruction, a memory card format file only for PMC message (an option file in CNC Flash-ROM only for message display which is importable/exportable via PCMCIA memory card) is added. The language of message actually displayed out of the memory card format file can be alternated synchronously with CNC Language parameter setting.

To create a memory card format file only for PMC message, a PC software tool “Multi-language PMC Message Creation Tool” is provided. European special character can be edited directly on the text editor without code input (@0D-01@), if the encoding of a text file is Unicode (UTF-16). About usable characters on a source file, please refer to “D.1.2 Usable characters”

This PC software tool is included in the installation disk of FANUC LADDER-III. And this tool can be used only with the personal computer in which FANUC LADDER-III is installed.

This tool can be executed by command line, so that the process of generating the file can be automated by batch command.

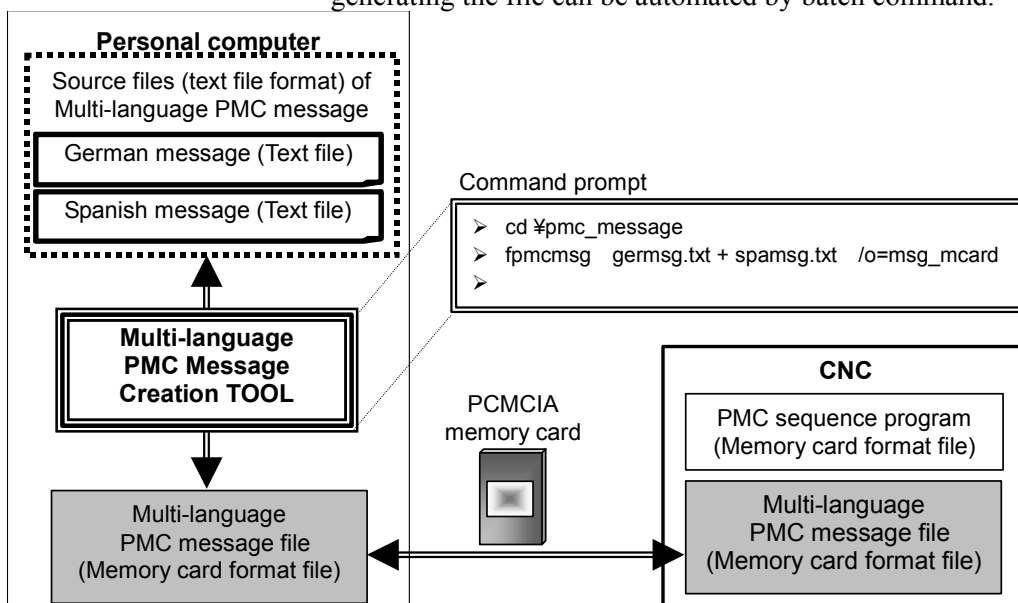

Applied PMC type

- 30i-A PMC
- 30i-A PMC(EXT)
- 30i-A PMC(2ND)
- 30i-A PMC(2ND,EXT)
- 30i-A PMC(3RD)
- 30i-A PMC(3RD,EXT)
- 31i-A PMC
- 31i-A PMC(EXT)
- 31i-A PMC(2ND)
- 31i-A PMC(2ND,EXT)
- 31i-A PMC(3RD)
- 31i-A PMC(3RD,EXT)
- 32i-A PMC
- 32i-A PMC(EXT)
- 32i-A PMC(2ND)
- 32i-A PMC(2ND,EXT)
- 32i-A PMC(3RD)
- 32i-A PMC(3RD,EXT)

CNC Option

- 1st-path PMC message multi-language display 128K :
A02B-0303-S977#128K
- 1st-path PMC message multi-language display 256K :
A02B-0303-S977#256K
- 2nd-path PMC message multi-language display 128K :
A02B-0303-S978#128K
- 3rd-path PMC message multi-language display 128K :
A02B-0303-S979#128K

NOTE

The number of messages and F-ROM size.

When F-ROM size is 128KB.

- PMC for Series 30i/31i/32i without extended function : 473 messages or more
- PMC for Series 30i/31i/32i with extended function : 435 messages or more

When F-ROM size is 256KB.

- PMC for Series 30i/31i/32i without extended function : 946 messages or more
- PMC for Series 30i/31i/32i with extended function : 870 messages or more

Above calculation is the case where:

The maximum size of one message data is as follows (When you use a global symbol).

- PMC for Series 30i/31i/32i without extended function : Maximum 277 bytes =
(Language ID 3bytes) + (Symbol 16bytes) + (Message string 255bytes) +
(delimiter 3bytes)
- PMC for Series 30i/31i/32i with extended function : Maximum 301 bytes =
(Language ID 3bytes) + (Symbol 40bytes) + (Message string 255bytes) +
(delimiter 3bytes)

Operating system

Windows 2000 Professional
Windows XP Professional
Windows XP Home Edition
Windows 98 SE
Windows Me

NOTE

- 1 In Windows 2000/XP, ASCII and Unicode(UTF-16) can be used in the encoding of a text file.
- 2 In Windows 98 SE/Me, ASCII is recommended in the encoding of a text file.

Overview

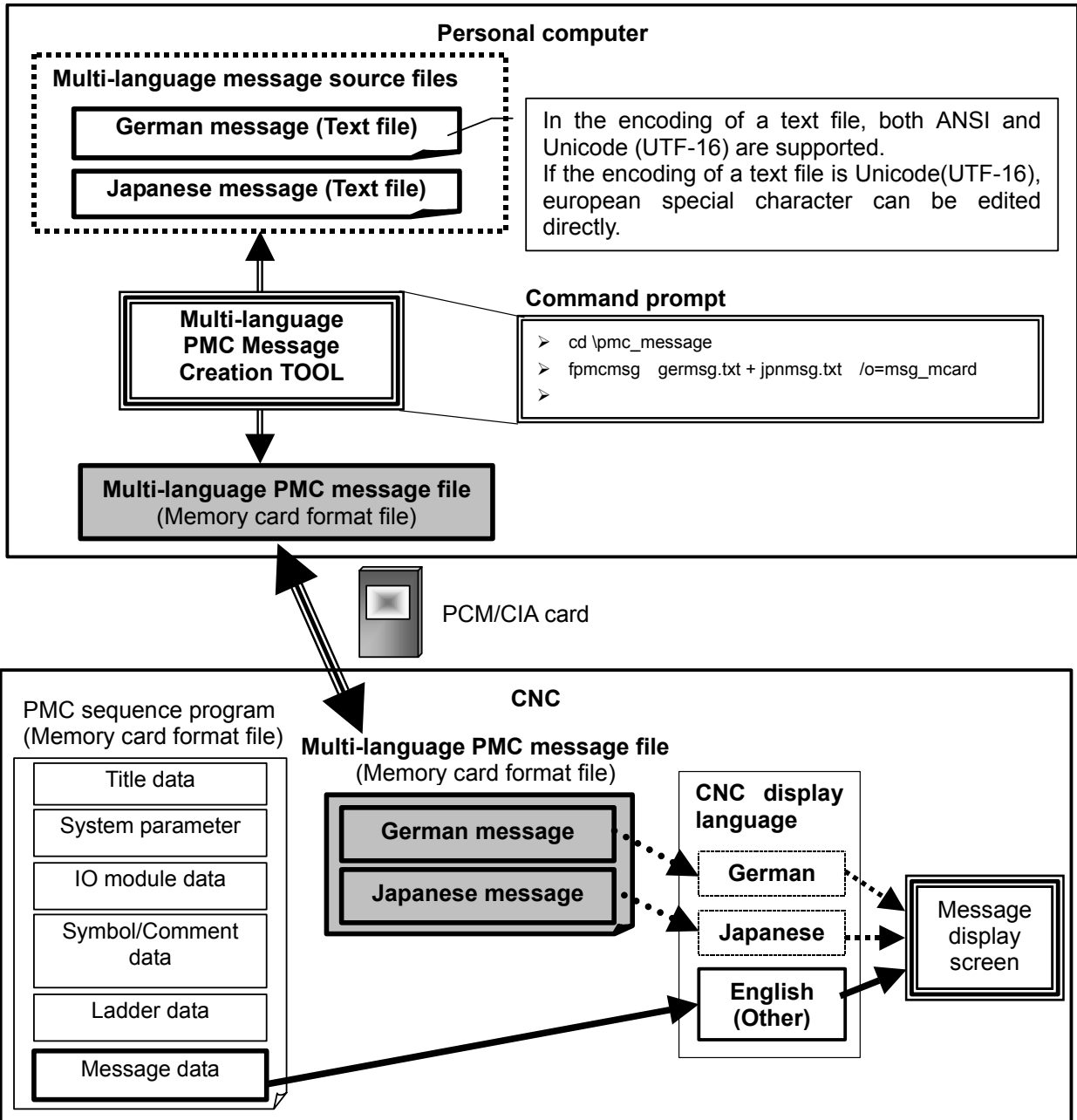

NOTE

- 1 Multi-language PMC message file can be loaded from CNC boot menu or PMC I/O screen through PCM/CIA card.
- 2 Multi-language PMC message can be modified without modifying the PMC sequence program.
- 3 When the alarm number of the same A address in PMC sequence program and multi-language PMC message is not corresponding, alarm number of PMC sequence program is displayed
- 4 In message data of PMC sequence program, please prepare the message number whenever you should display the message number. And please specify the same message number in multi-language PMC message file.

D.1 FILE FORMAT OF A MESSAGE SOURCE FILE

This section describes the source file format of multi-language PMC message.

- File format
File type : Text file
Encoding : ANSI / Unicode(UTF-16)

A message source file for multi-language display

(Identification code)
(Title information)
(Message data 1)
(Message data 2)
(Line comment)
(Message data 3)
:
(Message data n)
(Identification code)

- (a) Identification code
Specify the start/end of message data.
Start : %@4-D
End : :%
- (b) Title information
Title information is enclosed in double quotation marks.
Maximum length: 256 characters
Title information can be omitted.

The character string in title information is considered to be a language of OS excluding the part input by the character-code (@02xxxx01@, @0Dxxxx01@, e.t.c.).

- (c) Message data

	Language ID	Address (Symbol)	Message string
Ex.)	\$0	%A0000.0	DOOR OPEN
	\$0	%A0000.1	EMERGENCY STOP

The delimiter of each column is a white space character or a TAB code.

- (i) Language ID
A string of message is displayed according to the display language of CNC by specifying language ID.

Language ID

0: English	1: Japanese	2: German
3: French	4: Traditional Chinese	5: Italian
6: Korean	7: Spanish	8: Dutch
9: Danish	10: Portuguese	11: Polish
12: Hungarian	13: Swedish	14: Czech
15: Simplified Chinese		

(Example)

English -> \$0 (symbol or address) '(A string of message)'
 German -> \$2 (symbol or address) '(A string of message)'
 Korean -> \$6 (symbol or address) '(A string of message)'
 Simplified Chinese -> \$15 (symbol or address) '(A string of message)'

(ii) Address (Symbol)

Please describe % at the top of the address. The symbol is available only for PMC type of the extended function.

Method of specifying address

Method of specifying address	Example when describing	PMC type without extended function	PMC type with extended function
Address (with %)	%A0000.0	○	○
Global symbol	DOOR_OPEN	X	○
Local symbol	%P1.ON_DELAY_100MS	X	○
	TIMER.ON_DELAY_100MS	X	○
Address without %	A0123.4	X	✓

○ : Possible to specify, X: Impossible to specify

✓ : Address with % is strongly recommended.

(iii) Message string

Please refer to "D.1.2 Usable characters".

(d) Line comment

Line comment is enclosed in double quotation marks.

Line comment is not created into a multi-language PMC message file (memory card format file).

D.1.1 Sample File

(a) Encoding: ANSI

```
%@4-D
"Create : 11-Dec-2003 Edition : 0002
Multi-language message English / German / Japanese"
"English message"
$0 %P1.ALM1001 1001 FUSE IS BLOWN (SURGE KILLER)
$0 %A000.1 1002 EXT. EMERGENCY STOP SIGNAL ON
$0 ALM1003 1003 TIME OVER (M100-M109)
"German message"
$2 %P1.ALM1001 1001 FUSEIS BLOWN (SURGE KILLER)
$2 %A000.1 1002 EXT. EMERGENCY STOP SIGNAL ON
$2 ALM1003 1003 TIME @0DB101@VER (M100-M109)
"Japanese message"
$1 %P1.ALM1001 1001 ヒューズ切れ(サージキラー)
$1 %A000.1 1002 外部非常停止になりました
$1 ALM1003 1003 タイムオーバー (M100-M109)
%
```

NOTE

European special character can be entered by code input (@0D-01@) on a text editor not capable of Unicode.

(b) Encoding: Unicode (UTF-16)

```
%@4-D
"Create : 11-Dec-2003 Edition : 0002
Multi-language message English / German / Japanese"
"English message"
$0 %P1.ALM1001 1001 FUSE IS BLOWN (SURGE KILLER)
$0 %A000.1 1002 EXT. EMERGENCY STOP SIGNAL ON
$0 ALM1003 1003 TIME OVER (M100-M109)
"German message"
$2 %P1.ALM1001 1001 FUSEIS BLOWN (SURGE KILLER)
$2 %A000.1 1002 EXT. EMERGENCY STOP SIGNAL ON
$2 ALM1003 1003 TIME ÖVER (M100-M109)
"Japanese message"
$1 %P1.ALM1001 1001 ヒューズ切れ(サージキラー)
$1 %A000.1 1002 外部非常停止になりました
$1 ALM1003 1003 タイムオーバー (M100-M109)
%
```

NOTE

- 1 European special character (umlaut) can be edited directly by using appropriate text editor capable of Unicode (UTF-16)
- 2 When managing the message source files using other application software such as version management tools, such software is required to support the encoding of ANSI and Unicode (UTF-16).

D.1.2 Usable Characters

The types of characters usable in message text vary depending on the PMC model. See the following table for details.

Table D.1.2(a)

PMC	Characters that can be entered							
	Numerical characters	Alphabetical characters		Japanese characters		European special characters	Simplified Chinese characters	Korean (Hangul) characters
		Upper case	Lower case	JIS level-1/-2 kanji set	Half-size kana			
30i-A PMC 30i-A PMC(EXT) 30i-A PMC(2ND) 30i-A PMC(2ND, EXT) 30i-A PMC(3RD) 30i-A PMC(3RD, EXT) 31i-A PMC 31i-A PMC(EXT) 31i-A PMC(2ND) 31i-A PMC(2ND, EXT) 31i-A PMC(3RD) 31i-A PMC(3RD, EXT) 32i-A PMC 32i-A PMC(EXT) 32i-A PMC(2ND) 32i-A PMC(2ND, EXT) 32i-A PMC(3RD) 32i-A PMC(3RD, EXT)	A	A	A	B	A	B	A	B

A: Usable

B: Some characters cannot be displayed on CNC side. Multi-language PMC message creation tool cannot check whether they can be displayed.

- (a) Input method of European special characters
 - (i) Direct input (Only when the encoding of a text file is Unicode.)
 - (ii) Code input
Please input the code of european special character between @0D and 01@.
Ex.) TIME @0DB101@VER

About the code of European special characters, please see “Table D.1.2(b)”

- (b) Input method of JIS level1/2 kanji set
 - (i) Direct input using Japanese IME
 - (ii) Code input
Please input JIS code between @02 and 01@.
Ex 0248733E6F44643B5F01@

- (c) Input method of half size kana
 - (i) Direct input using Japanese IME
 - (ii) Code input
Please input half size kana code between @ and @.
Ex.) @CBADB0BDDE@
- (d) Input method of Simplified Chinese characters
 - (i) Direct input using Chinese IME
- (e) Input method of Korean characters
(Only when the encoding of a text file is Unicode.)
 - (i) Direct input using Korean IME

Table D.1.2(b) Code table of European special character (1/2)

Code	Char.	Code	Char.	Code	Char.	Code	Char.
A0	À	A8	É	B0	Ò	B8	Û
A1	Á	A9	Ê	B1	Ó	B9	Ü
A2	Â	AA	Ë	B2	Ô	BA	Ý
A3	Ã	AB	Ì	B3	Õ	BB	Þ
A4	Ä	AC	Í	B4	Ö	BC	ß
A5	Å	AD	Î	B5	Ù	BD	à
A6	Æ	AE	Ï	B6	Ú	BE	á
A7	Ç	AF	Ð	B7	Û	BF	â

Table D.1.2(b) Code table of European special character (2/2)

Code	Char.	Code	Char.	Code	Char.	Code	Char.
C0	À	C8	É	D0	Ò	D8	Ù
C1	Á	C9	Ê	D1	Ó	D9	Ú
C2	Ö	CA	Ë	D2	Ô	DA	Û
C3	Ü	CB	Ï	D3	Õ	DB	Ý
C4	Ñ	CC	Í	D4	Ö	DC	Ë
C5	Ç	CD	Î	D5	Ð		
C6	Ð	CE	Ï	D6	Ð		
C7	Ë	CF	Ñ	D7	Ú		

D.1.3 Entering Special Characters

D.1.3.1 New line character

Input method of new line character in the source file.

- (a) Direct input
Press <Enter> key
- (b) Code input
Please input "@0A@"

D.1.3.2 Numeric data

Input method of numerical data in the source file

- (a) Signed

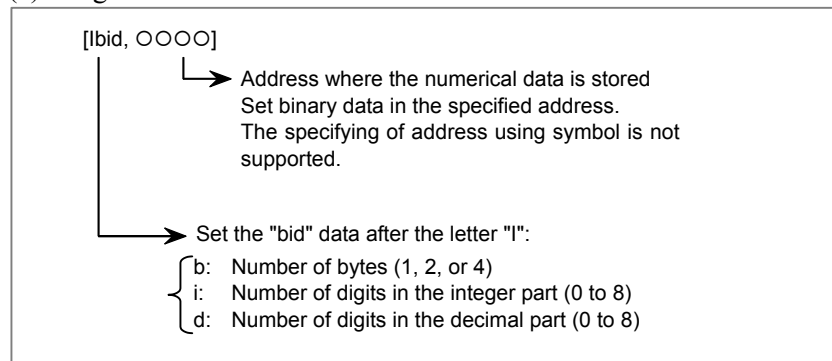

- (b) Unsigned

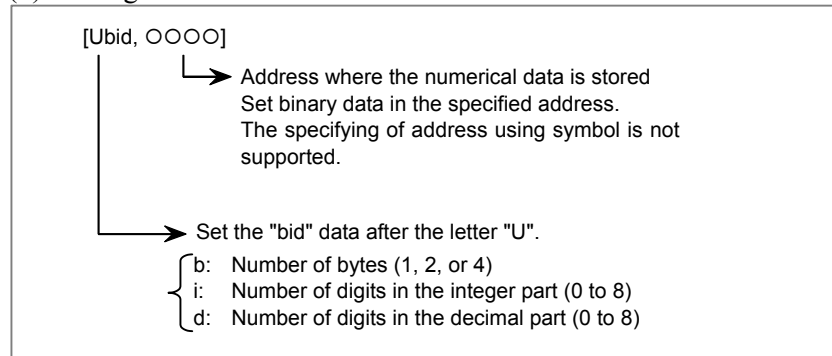

NOTE

- 1 Sum of integer part digits and fractional part digits must be within 8.
- 2 Blank is displayed for digits exceeding 8 digits.
- 3 Do not use any space between the brackets, [].

Example)

The following message includes 3 digits tool number at the spindle and the offset data (O.○○) for this tool. And these data are contained in memory address of 2bytes:

SPINDLE TOOL NO. = [I230, □□□□]

OFFSET DATA = [I212, ΔΔΔΔ]

D.1.3.3 Reservation character

@ is used to input codes (New line character and e.t.c.). And square brackets ([]) are used to input numeric data.

The above 3 characters are treated as a reservation character in the source file.

To display the reservation character in error message, you have to describe the reservation character as listed below.

(a) @ → @40@

(b) [→ @5B@

(c)] → @5D@

Example)

“@Fuse [100mA] is blown.” is as follows.

@40@Fuse @5B@100mA@5D@ is blown.

D.2 USAGE

This section describes the usage of multi-language PMC message creation tool.

This tool is included in the installation disk of FANUC LADDER-III. But this tool can be executed by command line, so that the process of generating the file can be automated by batch command.

- (1) Creating a memory card format file of multi-language PMC message file from source files.

```
Fmsgcnv [drive:][path]message-file1 [+ [drive:][path]message-file2] [+ ...]
          /m=[drive:][path]lad-mcard-file
          /l=[drive:][path]lad-file
          /p=pmc-path-number
          /o=[drive:][path] mcard-file
```

Parameter

[drive:][path]message-file1, [drive:][path]message-file2, ...

Specify the location and name of a multi-language message file.

Two or more multi-language message files can be specified by using +.

When only the file name is specified, the multi-language message file is considered to be on current folder.

/m=[drive:][path]lad-mcard-file

To confirm the multi-language message not correctly displayed, please specify this parameter.

In *lad-mcard-file*, specify the name of a sequence program (memory card format file) related to source files.

When only the file name is specified, *lad-mcard-file* is considered to be on current folder.

This parameter can be omitted.

/l=[drive:][path]lad-file

To confirm the multi-language PMC message not correctly displayed, please specify this parameter.

In *lad-file*, specify the name of .LAD file related to source files.

When only the file name is specified, *lad-file* is considered to be on current folder.

This parameter can be omitted.

Please do not execute this tool while the .LAD file specified by /l parameter has been opened by FANUC LADDER-III.

/p=pmc-path-number (1=1st-path PMC, 2=2nd-path PMC, 3=3rd-path PMC)

Specify the pmc path number of the separated message file.

When this parameter is omitted, multi-language PMC message file of 1st-path PMC is created.

/O=[drive:][path]mcard-file

Specify the location and name of a multi-language PMC message file.

When only the file name is specified, a multi-language PMC message file is created

(2) Creating a source file from a multi-language PMC message file.

```
Fmsgcnv [drive:][path]mcard-file  
          [/unicode]  
          /o=[drive:] [path]message-text-file
```

Parameter

[drive:][path]mcard-file

Specify the location and name of a multi-language PMC message file.

When only the file name is specified, a multi-language PMC message file is considered to be on current folder.

/unicode

The encoding of a source file becomes to Unicode.

When this parameter is omitted, the encoding of a source file becomes to ANSI.

/o=[drive:][path]message-text-file

Specify the location and name of a source file.

NOTE

- 1 FPMMSG.EXE exists on the install folder of FANUC LADDER-III.
(A default folder is "C:\Program Files\FANUC PMC Programmer\FANUC LADDER-3".)
- 2 Usually, FPMMSG.EXE sends the output of command to your screen.
To redirect the output of a command, use the greater-than sign (>).
The greater-than sign (>) sends the output of a command to a file or a device, such as a printer.
- 3 In creating a multi-language PMC message file from source files, line comment except title information is not created into a multi-language PMC message file.

[Example –1]

Create a multi-language PMC message file “msg_mcard” from a source file “multi_msg.txt”.

**Multi-language message text file (ANSI)
(multi_msg.txt)**

```
%@4-D
“Create : 11-Dec-2003  Edition : 0002
Multi-language message  English / German / Japanese”
“English message”
$0 ALM1001      1001 FUSE IS BLOWN (SURGE KILLER)
$0 %A000.1     1002 EXT. EMERGENCY STOP SIGNAL ON
$0 LEVEL1.ALM10031003.TIME OVER (M100-M109)
“German message”
$2 ALM1001      1001 FUSEIS BLOWN (SURGE KILLER)
$2 %A000.1     1002 EXT. EMERGENCY STOP SIGNAL
$2 LEVEL1.ALM10031003 TIME @0DB101@VER (M100-M109)
“Japanese message”
$1 ALM1001      1001 ヒューズ 切れ(サージ キラ-)
$1 %A000.1     1002 外部非常停止になりました
$1 LEVEL1.ALM10031003 タイムオーバー (M100-M109)
%
```



**1st-path PMC
multi-language
PMC message file
(msg_mcard)**

- Command

```
> cd \pmc_message
> fmsgcnv multi_msg.txt /o=msg_mcard
>
```

[Example –2]

Create a multi-language PMC message file of 2nd-path PMC from source files divided by a language.

English message text file (ANSI)

```
%@4-D
$0 ALM1001      1001 FUSE IS BLOWN (SURGE KILLER)
$0 %A000.1     1002 EXT. EMERGENCY STOP SIGNAL ON
$0 %P7.ALM1003 1003.TIME OVER (M100-M109)
```

German message text file (Unicode)

```
%@4-D
$2 ALM1001      1001 FUSEIS BLOWN (SURGE KILLER)
$2 %A000.1     1002 EXT. EMERGENCY STOP SIGNAL ON
$2 %P7.ALM1003 1003 TIME ÖVER (M100-M109)
```

Japanese message text file (ANSI(SHIFT-JIS))

```
%@4-D
$1 ALM1001      1001 ヒューズ 切れ(サージ キラ-)
$1 %A000.1     1002 外部非常停止になりました
$1 %P7.ALM1003 1003 タイムオーバー (M100-M109)
```



**2nd-path PMC
multi-language
PMC message file
(msg_mcard)**

Command

```
> cd \pmc_message
> fmsgcnv engmsg.txt + germsg.txt + jpnmsg.txt /p=2
> /o=msg_mcard
>
```

[Example-3]

Create a source file “multi_msg.txt” from a multi-language PMC message file “msg_mcard”.

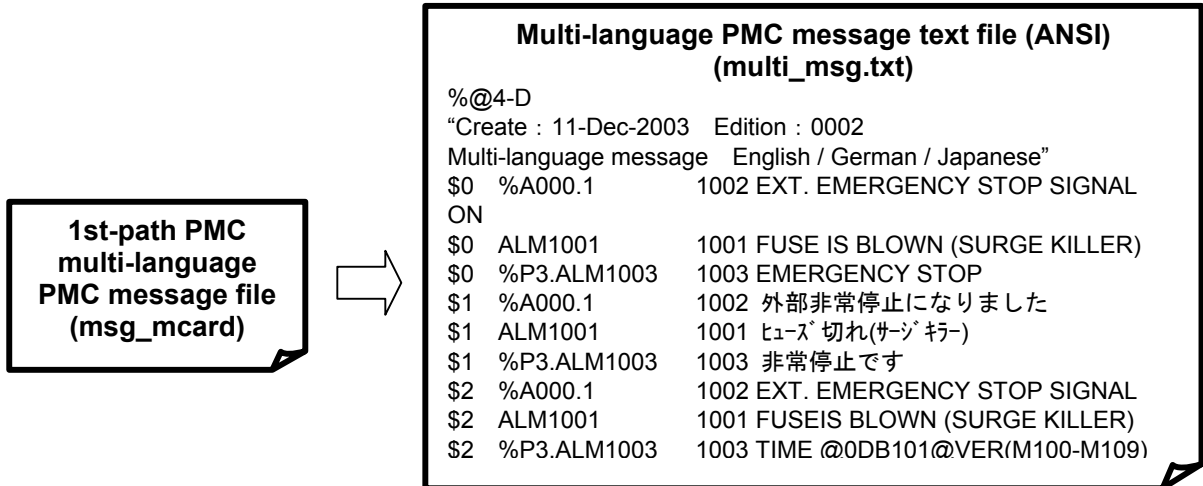
**- Command**

```

➤ cd \pmc_message
➤ fmsgcnv msg_mcard /o=multi_msg.txt
➤

```

[Example-4]

Create a source file “multi_msg.txt” with Unicode (UTF-16) from a multi-language PMC message file “msg_mcard”.

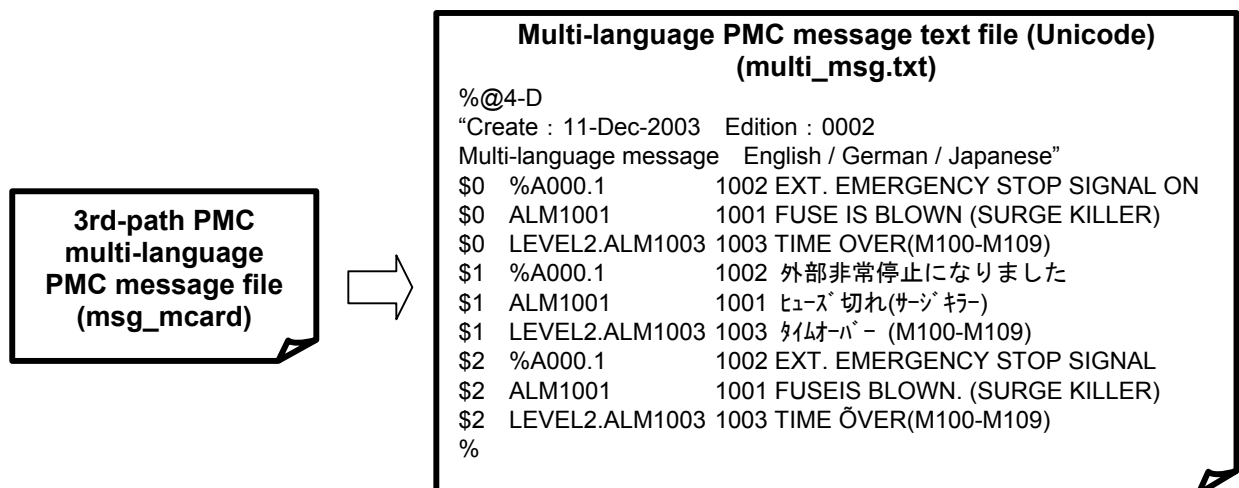
**- Command**

```

➤ cd \pmc_message
➤ fmsgcnv msg_mcard /unicode /o=multi_msg.txt
➤

```

D.3 ERROR MESSAGES

This section describes the error messages that may be displayed by Multi-language PMC Message Creation Tool.

D.3.1 Error List

Message	Cause & Remedy
filename(line number): Message file symbol undefined (Symbol:****)	The message was defined by the symbol which does not exist. (Ex.)When the message is defined for the undefined symbol "ALM1001". Message file symbol undefined (Symbol:ALM1001) * "Symbol undefined" is checked when /m or /l parameter is specified.
filename(line number): Message file symbol invalid (Symbol:****, Address:****)	The message was defined by the symbol which is not A address. (Ex.) When the address of symbol "ALM1001" is R0.1. Message file symbol invalid(Symbol:ALM1001, Address:R0000.1) * "Symbol invalid" is checked when /m or /l parameter is specified.
filename(line number): Message file address duplicate (Symbol:****, Address:****)	The message character string has already been defined in symbol **** (or Address:****). (Ex.) When two messages are defined in A0000.0 (The address of symbol "ALM1003" is A0000.0) Message file address duplicate (Address:A0000.0) Message file address duplicate (Symbol:ALM1003, Address:A0000.0) * "Address duplicate" is checked when /m or /l parameter is specified.
filename(line number): Message file number error (Ladder:mmmm, Source:nnnn)	Message number of the ladder program is not corresponding to message number of the source file. When displaying this message, message number of the ladder program is used. (mmmm and nnnn are message numbers.) (Ex.) In the sequence program, the message number in A0000.0 is 1001. In the source program, the message number in A0000.0 is 1234. (The message number 1001 is displayed on the CNC screen.) Message file number error (Ladder:1001, Sorce:1234) * "Number error" is checked when /m or /l parameter is specified.
filename(line number): Illegal address	An illegal address was specified.
filename(line number): Illegal language ID.	An illegal language ID was specified.
filename(line number): There is a character which cannot be displayed on CNC.	The character which cannot be displayed on CNC is included in the message character string . The character which cannot be displayed is replaced with '?', and output to the memory card format file.
filename(line number): Title information size over	The maximum size of title information is 256 bytes.

Message	Cause & Remedy
Command line error. “(command line character string)”	The mistake is found in the command line. Please check the command line character string.(Example: There are the same two parameters or more, etc)
Invalid parameter (/l, /m)	/l parameter and/m parameter is specified at the same time. Please specify only either parameter.
“LAD filename” /l parameter invalid	A memory card format file in the specified LAD file does not exist. Please compile the source program.
“filename” file open error	The specified file in the command line is not found. Or it can not be opened.
“filename” unsupported PMC type	The PMC type of the file specified by /m or /l parameter does not support “PMC message multi-language display function”.
“filename” Expected identification code “%@4-D”	Identification code is not found in the message source file.
“filename” Illegal file format	The specified file is not a source file, a memory card format file or a LAD file.
filename(line number): The number of maximum languages was exceeded. (Language ID:**)	16 languages or less can be made. The message of language ID** is not output.

E

DATA FORMAT OF THE EXTERNAL SYMBOL FILE

Convert the symbol and comment data to CSV (Comma Separated Value format), and add identification code at the top/bottom of the file.

- Identification code
It is the character string which starts with %. The external symbol file needs identification code ("%@2-E") for the symbol/comment of CSV.

Table E(a)

Identification code	Meaning
%@2-E(Optional)	Symbol and comment (CSV file)
%	End of data

E.1 OPTION OF IDENTIFICATION CODE

Specify the column of the symbol/comment in the parenthesis after %@2-E.

Table E.1(a)

Option	Description	Remarks	30i/31i/ 32i-A	30i/31i/32i-A Extended function
SYM=	Specify a column no. of symbol	1st column when omitted	Available	Available
SCP=	Specify a column no. of symbol scope (LEVEL1->L1, LEVEL2->L2, P0001->P1,,).	Symbol scope is global when omitted	Not available	Available
TYP=	Specify a column no. of symbol type (BOOL/BYTE/WORD/DWORD)	3rd column when omitted	Not available	Available
ADR=	Specify a column no. of address	4th column when omitted	Available	Available
CM1=	Specify a column no. of comment 1	The comment1, 2, 3, and 4 are not read when omitted.	Available	Available
CM2=	Specify a column no. of comment 2		Not available	
CM3=	Specify a column no. of comment 3			
CM4=	Specify a column no. of comment 4			
SEP=	Specify a character of delimiter	Delimiter is comma when omitting	Available	Available
+	Plus is used to connect strings of two or more comment columns	Example : CM1=5+10	Available	Available
JOI=	Specify a character to connect strings of two or more comment columns.	Strings of two or more columns are directly connected when omitted	Available	Available
LBL	The first effective line is a column label definition line.	When LBL exists, the conversion of the first line in effective data is skipped.	Available	Available
(white -space)	Delimiter of option setting		Available	Available

NOTE

- 1 If unsupported option is specified, warning will be displayed, and the option is disregarded.
- 2 If you use the quotation mark, please put the whole option among them.
(Example) "%@2-E(...)" or '%@2-E(...)'
" (the double quotation mark) is omissible.

The contents of option when Output

The identification code of the external symbol file is decided by existence of specification of an extended function.

- In 30i/31i/32i-A

Table E.1(b)

Identification code
%@2-E(SYM=1 ADR=2 CM1=3 CM2=4)
%

(Example output)

The symbol is the 1st row, the address is the 2nd row, the comment1 is the 3rd row and the comment2 is outputted to the 4th row.

```
%@2-E(SYM=1 ADR=2 CM1=3 CM2=4)
```

```
%@2-E(SYM=1 ADR=2 CM1=3 CM2=4)
STOP,Y0.0,Output Line No.43,Stop signal on
POWER_OFF,X32.0,Input Line No.183,Power off status
DOOR,X32.1,Input Line No.184,Safety door open
%
```

- In 30i/31i/32i-A Extended function

Table E.1(c)

Identification code
%@2-E(SYM=1 SCP=2 TYP=3 ADR=4 CM1=5 CM2=6 CM3=7 CM4=8)
%

(Example output)

The symbol is the 1st row, the address is the 2nd row, the type is the 3rd row, the program is the 4th row, the comment1 is the 5th row and and the comment2 is outputted to the 6th row.

```
%@2-E(SYM=1 ADR=2 TYP=3 SCP=4 CM1=5 CM2=6)
```

```
%@2-E(SYM=1 ADR=2 TYP=3 SCP=4 CM1=5 CM2=6)
STOP,Y0.0,BOOL,,Output Line No.43,Stop signal on
POWER_OFF,X32.0,BOOL,,Input Line No.183,Power off status
DOOR,X32.1,BOOL,,Input Line No.184,Safety door open
%
```

E.2 ABOUT THE CHARACTER OF THE EXTERNAL SYMBOL FILE

- About the unusable character of the external symbol file**
 In the 30i/31i/32i-A Extended function, if the following character is used for the symbol, the symbol is not read.

Unusable characters for the first character	% \$ (Example) %SYMBOL \$SYMBOL
Unusable characters	Space, Full-size Japanese character, :(Colon) ;(Semicolon) .(Period)

- About the export of an external symbol file**
 When you use '(single quotation mark), "(double quotation mark), and \$ (dollar) characters in the symbol or the comment, it is outputted to the external symbol file as follows.

Table E.2(a) Comment data

Screen display (Comment)	External symbol file	Remarks
'	'	\$ is added.
\$	\$\$	\$ is added.
"	""	" is added and double quote the whole comment with ".
,	","	Double quote the whole comment with ".

Table E.2(b) Symbol data

Screen display (Symbol)	External symbol file	Remarks
'	'	The same
\$	\$	The same
"	""	" is added and double quote the whole comment with ".
,	","	Double quote the whole comment with ".

- About the import of an external symbol file**
 When you use '(single quotation mark), "(double quotation mark), and \$ (dollar) characters in the symbol or the comment, it is necessary to write to the external symbol file as follows.

Table E.2(c) Comment data

External symbol file	Screen display (Comment)	Remarks
'	'	' is replaced with '.
\$\$	\$	\$\$ is replaced with \$.
""	"	"" is replaced with ".
","	,	"," is replaced with ,.

Table E.2(d) Symbol data

External symbol file	Screen display (Symbol)	Remarks
'	'	The same
\$	\$	The same
""	"	"" is replaced with ".
","	,	"," is replaced with ,.

E.3 COMPATIBILITY OF THE EXTERNAL SYMBOL FILE

- To read the external symbol file of 30i/31i/32i-A in 30i/31i/32i-A extended function

Operation

1. Display the export screen in 30i/31i/32i-A, and output the external symbol file.

```
%@2-E(SYM=1 ADR=2 CM1=3 CM2=4)
STOP,Y0.0,Output Line No.43,Stop signal on
POWER_OFF,X32.0,Input Line No.183,Power off status
DOOR,X32.1,Input Line No.184,Safety door open
%
```

2. Display the import screen in 30i/31i/32i-A extended function, and input the external symbol file.
The following types are set by the address if TYP option is not specified.

Bit address	BOOL
Byte address	BYTE
L address	LABEL
P address	PROG

About the unusable character of the symbol

The symbol is not read if the following unusable character is used for the symbol.

Unusable characters for the first character	% \$ (Example) %SYMBOL \$SYMBOL
Unusable characters	Space, Full-size Japanese character, :(Colon) :(Semicolon) .(Period)

Operation

- **To read the external symbol file of 30i/31i/32i-A extended function in 30i/31i/32i-A**
1. Display the export screen in 30i/31i/32i-A extended function. Check Performing automatic address assignment. Output the external symbol file.
 2. Display the import screen in 30i/31i/32i-A, and input the external symbol file.
 3. When reading the external symbol file for 30i/31i/32i-A, there are the following limitations.

Table E.3(a) Limitations

Items	Contents
The symbol character is over 17 characters.	The symbol is not read. Reads the address and the comment, when there is the comment.
The comment character is over 31 characters.	Reads to until 30 characters. The 1st comment and the 2nd comment are read as the comment of 30 characters. The 3rd comment and the 4th comment are not read.
Local symbol	The local symbol is not read. Only the global symbol is read.
Automatically assigned address	Cannot read the symbol of only the address character. When you output the external symbol file, assign the address using the automatic address assignment function.

INDEX

<Symbol>

- *.LAD File is Changed to Other PMC Type of "*.LAD"
File 377

<A>

- ABOUT SYMBOL/COMMENT DATA 385
- ABOUT THE CHARACTER OF THE EXTERNAL
SYMBOL FILE 496
- About the Deletion of the Unused Net Comment 161
- About the Distinction of Symbol and Address 388
- About the Symbol Type 388
- ACTIVATING THE I/O Link 351
- Add New Symbol and Comment 391
- Adding Ladder Subprograms 61
- Adding Page Breaks 67
- Adding Step Sequence Subprograms 136
- Addition of Symbol/Comment and Net Comment 247
- Address Decision 415
- ALL format 265
- AUTOMATIC ADDRESS ASSIGNMENT
FUNCTION 413
- AUTOMATIC COMPILATION AND
DECOMPILATION 233
- Automatic input of the CTR parameter of a functional
instruction 117
- Automatic input of the TMR parameter of a functional
instruction 116
- Automatic Input of Timer, Counter, Rising /
Falling-Edge Numbers 114
- AUTOMATIC NUMBERING OF TMRB/ TMRBF/
DIFU/ DIFD 238
- Automatic Sampling Function at Power-on 360
- Automatic Signal Sampling Function at Power-On 349
- Automatic Trace Function at Power-On 341

- BASICS 11
- Batch Command Execution 272
- Beginning of Parallel Branch 132
- Beginning of Selective Branch 131

<C>

- C ADDRESS (COUNTER) 425

- CABLE FOR DATA TRANSFER 469
- Changing Contacts and Coils in the Display Window 88
- Changing Ladder Programs 46
- Changing Ladder Programs on the Display Window 94
- Changing Signal Addresses and Function Instruction
Parameters in the Display Window 87
- Changing the ladder editing mode 94
- CHECKING DUPLICATE COIL 180
- Checking Syntax 135
- Checking the Number of Program Steps 89
- CLEARING PMC AREAS 350
- Closing an *.LAD File 364
- CLOSING PROGRAMS 163
- Collective Display 75
- Collective Display function 401
- COMMAND LINE EXECUTION FUNCTION 361
- COMMAND SPECIFICATIONS 364
- COMMANDS 363
- Comment of Contact and Coil 398
- [Communication] Dialog Box 274
- COMPARING WITH PMC 298
- COMPATIBILITY OF THE EXTERNAL SYMBOL
FILE 497
- COMPILATION 222, 419
- COMPILATION AND DECOMPILATION 221
- Compile 451
- Compiling an *.LAD File 365
- Conversion by Changing System Parameters 439
- CONVERSION USING A SIGNAL ADDRESS
CONVERTER 470
- Converting a Mnemonic File to the Source Program 370
- CONVERTING FROM DOS-VERSION FANUC
LADDER-II 436
- Converting Mnemonic File 433
- CONVERTING MNEMONIC FILES TO SOURCE
PROGRAMS 245
- CONVERTING SEQUENCE PROGRAMS 435
- CONVERTING SEQUENCE PROGRAMS
BETWEEN PMC MODELS 439
- CONVERTING SOURCE PROGRAMS TO
MNEMONIC FILES 241
- CONVERTING STEP SEQUENCE PROGRAMS TO
MNEMONIC FILES 266

Converting the Source Program of an *.LAD File to a Mnemonic File	369	Editing Net Comments	64
CONVERTING TO DOS-VERSION FANUC LADDER-II	438	EDITING STEP SEQUENCES	118
CONVERTING TO MNEMONIC.....	417	EDITING SYMBOL AND COMMENT	389
CONVERTING TO SOURCE PROGRAMS	416	EDITING SYMBOLS AND COMMENTS	139
Converts to the External Symbol File	243	EDITING SYSTEM PARAMETERS.....	155
Counter.....	322	EDITING TITLES	36
Create Ladder Program of Extended Function and Change to Source File.....	434	End of Parallel Branch	132
Creating a New *.LAD File	376	End of Selective Branch.....	131
CREATING AND EDITING SEQUENCE PROGRAMS.....	19	Entering and Deleting Vertical Lines	60
CREATING NEW PROGRAMS.....	28	Entering and deleting vertical lines	105
Cut, Copy and Paste of Symbol or Comment Data	393	Entering basic instructions	51, 96
<D>		Entering function instructions	55, 100
D ADDRESS (DATA TABLE)	426	Entering horizontal lines	59, 104
Data for PMC control software	324	Entering Special Characters	485
DATA FORMAT OF THE EXTERNAL SYMBOL FILE	493	Entering Steps	129
Data Table	325	Entering Transitions	130
DECOMPILATION	227, 420	Error List.....	491
Decompile	457	ERROR MESSAGE FORMAT.....	443
Decompiling an *.LAD File.....	367	ERROR MESSAGES.....	442, 445, 491
Deleting collective display extraction conditions.....	81	EXECUTING AND STOPPING SEQUENCE PROGRAMS.....	301
Deleting Ladder Subprograms.....	62	Executing collective display.....	79
Deleting Net Comments.....	66	EXECUTING SEQUENCE PROGRAMS.....	302
Deleting Nets.....	69	Executing the signal trigger stop function.....	310
Deleting Page Breaks	68	EXECUTION LOG FILE	381
Deleting Step Sequence Subprograms.....	137	Export of the External Symbol File.....	176
Deleting Symbol and Comment Data.....	393	Exporting Data to the Specified File	374
Deleting Symbol or Comment Data	106	EXPORTING PROGRAMS	172
Device Selection	26	EXTENDED SYMBOL/COMMENT FUNCTION.....	383
DIAGNOSIS	304	<F>	
Display Items	337	File	445
DISPLAYING VERSION INFORMATION	18	FILE FORMAT OF A MESSAGE SOURCE FILE.....	478
Duplicate Coil Screen	180	FORMAT OF EXTERNAL SYMBOL FILE	269
<E>		Function Symbols.....	443
Edit Toolbar	17	<G>	
[Edit] Screen	307	[Gridline Format] Screen.....	349
EDITING I/O MODULE ASSIGNMENT	152	<H>	
EDITING LADDER DIAGRAMS	38, 395	How to Add Sub-program	406
EDITING MESSAGES.....	145	How to Change Symbol or Address	399
		HOW TO CONVERT FROM CONVENTIONAL MODEL	433
		How to Create Ladder Program.....	397
		How to Display and Modify Ladder Program	395

How to View whole Program.....	395	Mnemonic Conversion.....	459
</>		MNEMONIC EDITING.....	240
I/O module.....	264	MNEMONIC FILE FORMAT.....	249, 429
I/O Module Editing.....	446	MNEMONIC FILE SAMPLE.....	253
Import of the External Symbol File.....	170	Mnemonic Monitor.....	313
Importing Data from the Specified File.....	372	MNEMONIC OPTIONS.....	267
IMPORTING PROGRAMS.....	164	Models and Quantity of Usable Characters.....	147
Input data range.....	327	Modifying collective display extraction conditions.....	80
Input of Jump Label by Symbolic Name.....	408	Modifying Symbol and Comment Data.....	392
INPUT/OUTPUT.....	273	[Monitor] Screen.....	306
Input/Output.....	465	MULTI-LANGUAGE PMC MESSAGE CREATION	
Inserting an edit line.....	95	TOOL.....	474
Inserting Ladders from the Edit Window into a Ladder		Multiple used check of the functional instruction	
Program.....	49	parameter number.....	308
Installation.....	3	<N>	
INSTALLATION AND UNINSTALLATION.....	3	New line character.....	485
<K>		New Line Character, Numeric Data.....	148
K ADDRESS (KEEP RELAY).....	426	NOTE.....	380
Keep Relay.....	323	Notes at Editing Ladder Program.....	407
<L>		Numeric data.....	485
Ladder.....	263	<O>	
Ladder.....	432	Opening an *.LAD File.....	364
Ladder Diagram is Outputted to the Text File.....	109	OPENING EXISTING PROGRAMS.....	31
Ladder diagram without the net number is output to the		OPENING MOST RECENTLY USED PROGRAMS..	179
text file.....	113	Opening Programs Opened by Another User.....	32
LADDER MONITORING.....	305	Opening Programs with the Read-only Attribute.....	34
Ladder/Step Sequence Editing.....	447	OPERATING ENVIRONMENT.....	2
LANGUAGE PROGRAM LINK FUNCTION.....	472	Operation to Import from CSV-file.....	271
LOADING SEQUENCE PROGRAMS FROM THE		Option.....	270
PMC (DURING CONNECTION WITH THE PMC) ...	287	OPTION OF IDENTIFICATION CODE.....	494
LOADING SEQUENCE PROGRAMS FROM THE		[Option] Dialog Box.....	278
PMC (DURING DISCONNECTION WITH THE		<P>	
PMC).....	280	Parameter.....	253
<M>		Partial Protect Functions.....	236
Main Menu.....	14	PMC ALARM STATUS.....	334
Memory Addresses Required to Display Messages.....	147	PMC PARAMETERS.....	320
Menu Bar.....	298	PMC Programming Method.....	24
Message.....	264	PMC STATUS.....	336
Message Classification.....	444	PMC TYPE CHANGED AND SAVE.....	184
Message Editing.....	451	PREFACE.....	p-1
Method of Displaying the Ladder Diagram Editing		Preparing for Offline Editing.....	38
Screen.....	40	Preparing for Online Editing.....	39
		Print.....	451

PRINTING	421
PRINTING BIT ADDRESS MAPS	208
Printing Cross Reference	423
PRINTING CROSS-REFERENCES	204
PRINTING I/O MODULE ASSIGNMENT	200
PRINTING LADDER DIAGRAMS	190
PRINTING MESSAGES	198
PRINTING SEQUENCE PROGRAMS	187
PRINTING STEP SEQUENCES	193
PRINTING SYMBOLS AND COMMENTS	195
PRINTING SYSTEM PARAMETERS	202
Printing the Bit Address	423
Printing the Ladder Diagram	422
Printing the Symbol Comment	421
Printing the System Parameters	421
PRINTING TITLES	188
Procedure for Creating Sequence Programs	20
Program Importing Function from Memory Card Files ..	34
Program Transfer Wizard	299
Programmer protect function	328
PROTECTING LADDER PROGRAMS BY PASSWORDS	234
<R>	
Relation between the global symbol and the local symbol	386
Replace	91
Replace function	404
Reservation character	486
<S>	
SAFETY PRECAUTIONS	s-1
SAMPLE COMMAND FILE	380
Sample File	480
Sample of an External Symbol File	270
SAVING AND READING OPTION FILE	211
SAVING PROGRAMS	160
SAVING PROGRAMS WITH NAMES	162
Search	70, 138, 393
Search function	399
Selecting a transfer direction	300
Selecting a transfer method	299
SEQUENCE PROGRAMS	20
Set of Display Language for Comment	418
Set of Symbol	414
Set Screen	413
Setting collective display extraction conditions	75
Setting Details of Trace Mode	357
Setting items	330
Setting Ladder Display	82
Setting PMC Setting Parameters	328
Setting Property	220
Setting screen of the selectable I/O link assignment function	333
Setting the maximum number of undo operations	108
Setting Trace Parameters	355
Setting Trace Parameters (Sampling Addresses)	358
SETTING UP COMMON OPTIONS	210
SETTING UP COMMUNICATION	274
Setting up Ethernet	276, 279
Setting up Pages	215
SETTING UP PRINTER	214
Setting up RS-232C	274, 278
SETUP	1
Shortcut key list	313
SIGNAL ANALYSIS	342
[Signal Analysis Format] Screen	348
[Signal Analysis Parameter] Screen	346
SIGNAL STATUS	317, 424
SIGNAL TRACE FUNCTION	352
[Signal Trace Parameter] Screen	340
SIGNAL TRACING	338
SIGNAL TRACING	427
Signal Trigger Stop Function	309
Single Format	253
Soft key	74, 17
Specifying Jump-to Label	133
Specifying Label Jump	134
START AND END	12
Starting FANUC LADDER-III	12
Starting FANUC LADDER-III (Online Connection)	12
Status Monitor	17
Step Sequence Configuration	122
STOPPING SEQUENCE PROGRAMS	303
STORING SEQUENCE PROGRAMS IN THE PMC (DURING CONNECTION WITH THE PMC)	289, 295
Switching the Language in which PMC Alarm Messages are Displayed	335
Symbol and comment	262

Symbol and Comment Data	139
Symbol Comment.....	431
SYSTEM PARAMETER	418
System Parameter.....	429
System Parameter Editing.....	447

<T>

T ADDRESS (TIMER)	425
Terminating Command Processing	379
Terminating FANUC LADDER-III	12
Terminating the signal trigger stop function	311
The example of an output file	112
Timer.....	320
Title.....	262
Title Editing	446
Tool Tip	398
TOOLTIPS INDICATION.....	428
[Trigger Parameter] screen.....	312

<U>

Undo / Redo	107
Uninstallation.....	9
Usable Characters.....	481
USAGE	487
Using System Program Data for Another Program	441

<W>

Warning message	332
WINDOW NAMES AND FUNCTIONS.....	13
Work Folders and Online Program Files.....	25
WRITING SEQUENCE PROGRAMS INTO F-ROM.....	297

Revision Record

FANUC LADDER-III OPERATOR'S MANUAL (B-66234EN)

03	Sep., 2001	<ul style="list-style-type: none"> - Addition of following items 3.5.16 Setting the Number of Contacts and Coils per Row 3.5.17 Changing Signal Addresses and Function Instruction Parameters in the Display Pane 3.16 OPENING MOST RECENTLY USED PROGRAMS 7.1 SETTING UP COMMUNICATION 7.7 COMPARING WITH PMC 9.4.2 Switching the Language in Which PMC Alarm Messages Are Displayed Appendix C LANGUAGE PROGRAM LINK FUNCTION - Replacement of the screens - Addition of the other explanations - Correction of errors 			
02	Jul., 2000	<ul style="list-style-type: none"> - Addition of following items 3.3.2 Opening Programs Opened by Another User 3.3.3 Opening Programs with the Read-only Attribute 3.5.13 Search 3.5.14 Collective Display 3.5.15 Setting the Number of Columns per Row 3.6.13 Search 9.1.4 Signal Trigger Stop Function Appendix B CONVERSION USING A SIGNAL ADDRESS CONVERTER - Replacement of the screens - Addition of the other explanations - Correction of errors 	05	Dec., 2004	<ul style="list-style-type: none"> - Total revision <ul style="list-style-type: none"> · Applied to Series 30i/31i/32i PMC · Addition of "Extended symbol/comment function" · Addition of "Multi-language PMC message creation tool" - Correction of errors
01	Apr., 2000		04	Nov., 2002	<ul style="list-style-type: none"> - Addition of following items <ul style="list-style-type: none"> 3.5.19 Setting Ladder Display 3.5.22 Checking the Number of Program Steps 3.5.23 Replace 3.5.24 Changing Ladder Programs on the Display Window 3.5.25 Deleting Symbol or Comment Data 6.5 CONVERTING STEP SEQUENCE PROGRAMS TO MNEMONIC FILES 10 COMMAND LINE EXECUTION FUNCTION - Replacement of the screens - Addition of the other explanations - Correction of errors
Edition	Date	Contents	Edition	Date	Contents

- *No part of this manual may be reproduced in any form.*
- *All specifications and designs are subject to change without notice.*