



Chipsmall Limited consists of a professional team with an average of over 10 year of expertise in the distribution of electronic components. Based in Hongkong, we have already established firm and mutual-benefit business relationships with customers from,Europe,America and south Asia,supplying obsolete and hard-to-find components to meet their specific needs.

With the principle of “Quality Parts,Customers Priority,Honest Operation,and Considerate Service”,our business mainly focus on the distribution of electronic components. Line cards we deal with include Microchip,ALPS,ROHM,Xilinx,Pulse,ON,Everlight and Freescale. Main products comprise IC,Modules,Potentiometer,IC Socket,Relay,Connector.Our parts cover such applications as commercial,industrial, and automotives areas.

We are looking forward to setting up business relationship with you and hope to provide you with the best service and solution. Let us make a better world for our industry!



Contact us

Tel: +86-755-8981 8866 Fax: +86-755-8427 6832

Email & Skype: info@chipsmall.com Web: www.chipsmall.com

Address: A1208, Overseas Decoration Building, #122 Zhenhua RD., Futian, Shenzhen, China



CRYSTAL OSCILLATOR (SPXO)
OUTPUT : CMOS, TTL
SG - 645 / SG - 636 series

- Frequency range : 2.21675 MHz to 135 MHz
- Supply voltage : 2.5 V Typ. / 3.3 V Typ. / 5.0 V Typ.
- Function : Output enable(OE) or Standby(\overline{ST})
- External dimensions : 7.1 × 5.1 × 1.5 mm (t: Max.)...SG-645
10.5 × 5.8 × 2.7 mm (t: Max.)...SG-636

Product Number (please contact us)
SG-645 : Q33645xx2xxxx00
SG-636 : Q33636xx2xxxx00

Actual size

SG-645 series



SG-636 series

Specifications (characteristics)

Item	Symbol	Specifications			Conditions / Remarks
		SG-636 PTF	SG-636 PCE SG-636 SCE	SG-636 PDE	
Output frequency range	f_o	2.21675 MHz to 41.000 MHz	2.21675 MHz to 40.000 MHz	2.21675 MHz to 40.000 MHz	Please contact us about available frequencies.
Supply voltage	V_{cc}	5.0 V \pm 0.5 V	3.3 V \pm 0.3 V	2.5 V \pm 0.25 V	
Storage temperature	T_{stg}	-55 °C to +100 °C			Storage as single product.
Operating temperature	T_{use}	-20 °C to +70 °C			
Frequency tolerance	f_{tol}	C: $\pm 100 \times 10^{-6}$			-20 °C to +70 °C
Current consumption	I_{cc}	17 mA Max.	9 mA Max.	5 mA Max.	No load condition
Disable current	I_{dis}	10 mA Max.	5 mA Max.	3 mA Max.	OE=GND
Stand-by current	I_{std}	—	2 μ A Max.	—	\overline{ST} =GND(SCE)
Symmetry	SYM	40 % to 60 %	45 % to 55 %		CMOS load:50 % V_{cc} level
		45 % to 55 %	—		TTL load: 1.4 V level
Output voltage	V_{OH}	V_{cc} -0.4 V Min.			I_{OH} =-8 mA(PTF) / -4 mA(SCE,PCE) / -3.2 mA(PDE)
	V_{OL}	0.4 V Max.			I_{OL} =16 mA(PTF) / 4 mA(SCE,PCE) / 3.2 mA(PDE)
Output load condition (TTL)	L_{TTL}	10 TTL Max.	—		$L_{CMOS} \leq 15$ pF
Output load condition (CMOS)	L_{CMOS}	50 pF Max.	30 pF Max.	15 pF Max.	
Input voltage	V_{IH}	2.0 V Min.	80 % V_{cc} Min.		OE Terminal or \overline{ST} Terminal (SCE)
	V_{IL}	0.8 V Max.	20 % V_{cc} Max.		
Rise time / Fall time	t_r / t_f	7 ns Max.	5 ns Max.		CMOS load:20 % V_{cc} to 80 % V_{cc} level
		5 ns Max.	—		TTL load:0.4 V to 2.4 V level
Start-up time	t_{str}	4 ms Max.	4 ms Max.		Time at minimum supply voltage to be 0 s
Frequency aging	f_{aging}	$\pm 5 \times 10^{-6}$ / year Max.			+25 °C, V_{cc} =5.0 V/3.3 V/2.5 V, First year

Specifications (characteristics)

Item	Symbol	Specifications			Conditions / Remarks
		SG-636 PTG	SG-636 PHG	SG-636 PCG SG-636 SCG	
Output frequency range	f_o	2.21675 MHz to 33.000 MHz *1			Please contact us about available frequencies.
Supply voltage	V_{cc}	4.5 V to 5.5 V	2.7 V to 3.6 V		
Storage temperature	T_{stg}	-55 °C to +100 °C			Storage as single product.
Operating temperature	T_{use}	-20 °C to +70 °C			
Frequency tolerance	f_{tol}	B: $\pm 50 \times 10^{-6}$ C: $\pm 100 \times 10^{-6}$			-20 °C to +70 °C
Current consumption	I_{cc}	25 mA Max.	12 mA Max.		No load condition
Disable current	I_{dis}	20 mA Max.	10 mA Max.		OE=GND (PTG,PHG,PCG)
Stand-by current	I_{std}	—	50 μ A Max.		\overline{ST} =GND (SCG)
Symmetry	SYM	40 % to 60 %	45 % to 55 %		50 % V_{cc} level, L_{CMOS} =25 pF
		2.4 V Min.	—		1.4 V level, L_{CMOS} =25 pF
Output voltage	V_{OH}	—	V_{cc} -0.4 V Min.	—	I_{OH} =-8 mA
	V_{OL}	—	—	0.4 V Max.	I_{OH} =-16 mA
Output load condition	L_{CMOS}	0.4 V Max.			I_{OL} =8 mA
		25 pF Max.	—		I_{OL} =16 mA
Input voltage	V_{IH}	2.0 V Min.	70 % V_{cc} Min.		OE Terminal or \overline{ST} Terminal
	V_{IL}	0.8 V Max.	20 % V_{cc} Max.		
Rise time / Fall time	t_r / t_f	—	3.4 ns Max.	4 ns Max.	20 % V_{cc} to 80 % V_{cc} level, $L_{CMOS} \leq 25$ pF
		2.4 ns Max.	—		TTL load:0.4 V to 2.4 V level, $L_{CMOS} \leq 25$ pF
Start-up time	t_{str}	12 ms Max.			$t=0$ at 90 % V_{cc}
Frequency aging	f_{aging}	$\pm 5 \times 10^{-6}$ / year Max.			+25 °C, V_{cc} =5.0 V/3.3 V, First year

 *1 4.1250 MHz < f_o < 4.4336 MHz, 8.2500 MHz < f_o < 8.8672 MHz, 16.500 MHz < f_o < 17.7344 MHz : Unavailable

Specifications (characteristics)

Item	Symbol	Specifications			Conditions / Remarks
		SG-636 PTW / STW SG-645 PTW / STW	SG-636 PHW / SHW SG-645 PHW / SHW	SG-636 PCW / SCW SG-645 PCW / SCW	
Output frequency range	f _o	32.001 MHz to 135.000 MHz			Please contact us about available frequencies.
Supply voltage	V _{cc}	5.0 V ±0.5 V		3.3 V ±0.3 V	
Storage temperature	T _{stg}	SG-636***: -55 °C to +100 °C / SG-645***: -55 °C to +125 °C			Storage as single product.
Operating temperature	T _{use}	-20 °C to +70 °C			
Frequency tolerance	f _{tol}	B: ±50 × 10 ⁻⁶ C ² : ±100 × 10 ⁻⁶		M: ±100 × 10 ⁻⁶	SG-645PCW / SCW Only -20 °C to +70 °C -40 °C to +85 °C : SG-645PCW / SCW Only
Current consumption	I _{cc}	45 mA Max.		28 mA Max.	No load condition (Max. frequency range)
Disable current	I _{dis}	30 mA Max.		16 mA Max.	OE=GND (PTW,PHW,PCW)
Stand-by current	I _{std}	50 μA Max.			ST=GND (STW,SHW,SCW)
Symmetry	SYM	40 % to 60 %		40 % to 60 %	50 % V _{cc} level, L _{CMOS} =Max. 1.4 V level, L _{CMOS} =Max.
Output voltage	V _{OH}	V _{cc} -0.4 V Min.			I _{OH} =-16 mA (PTW , STW , PHW , SHW) -8 mA (PCW , SCW)
	V _{OL}	0.4 V Max.			I _{OL} = 16 mA (PTW , STW , PHW , SHW) / 8 mA (PCW , SCW)
Output load condition (TTL)	L _{TTL}	5 TTL Max.	—	—	f _o ≤ 90 MHz, Max. Supply voltage.
Output load condition (CMOS)	L _{CMOS}	15 pF Max.			Max. frequency, Max. Supply voltage.
Input voltage	V _{IH}	2.0 V Min.		70 % V _{cc} Min.	OE Terminal or ST Terminal
	V _{IL}	0.8 V Max.		20 % V _{cc} Max.	
Rise time / Fall time	t _r / t _f	4 ns Max.		4 ns Max.	20 % V _{cc} to 80 % V _{cc} level, L _{CMOS} ≤ Max. 0.4 V to 2.4 V level
Start-up time	t _{str}	10 ms Max.			Time at minimum supply voltage to be 0 s
Frequency aging	f _{aging}	±5 × 10 ⁻⁶ / year Max.			+25 °C, V _{cc} =5.0 V / 3.3 V, First year

*2 SG-636 series "C" tolerance : 40 MHz < f_o ≤ 135 MHz

Product Name SG-645 P T W 135.000000MHz B
 (Standard form) ① ②③ ④ ⑤
 ① Model ② Function (P: Output enable, S: Standby)
 ③ Supply voltage ④ Frequency
 ⑤ Frequency tolerance

③ Supply voltage	
D	2.5 V Typ.
C	3.3 V Typ.
T,H	5.0 V Typ.

⑤ Frequency tolerance	
B	±50 × 10 ⁻⁶ / -20 to +70°C
C	±100 × 10 ⁻⁶ / -20 to +70°C
M	±100 × 10 ⁻⁶ / -40 to +85°C

External dimensions (Unit:mm)

Footprint (Recommended) (Unit:mm)

● SG-645 series

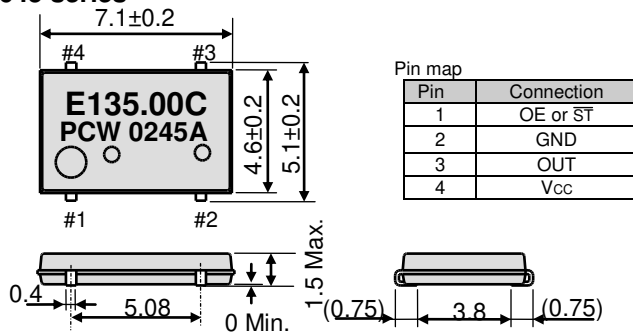

● SG-636 series

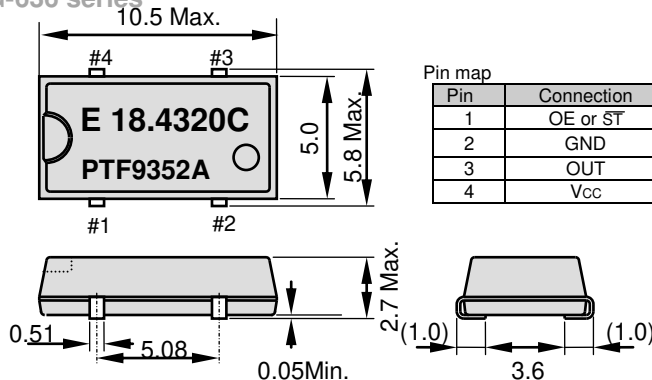

The metal case inside of the molding compound may be exposed on the top or bottom of this product. This purely cosmetic and does not have any effect on quality, reliability or electrical specs.

Note:
 OE pin (PTF,PCE,PDE,PTW,PHW,PCW,PTG,PHG,PCG)
 OE pin = "H" or "open": Specified frequency output.
 OE pin = "L": Output is high impedance.

ST pin (STW, SHW, SCW, SCG)
 ST pin = "H" or "open": Specified frequency output.
 ST pin = "L": Output is low level (weak pull - down), oscillation stops.

ST pin (SCE)
 ST pin = "H" or "open": Specified frequency output.
 ST pin = "L": Output is low level, oscillation stops.

● SG-645 series

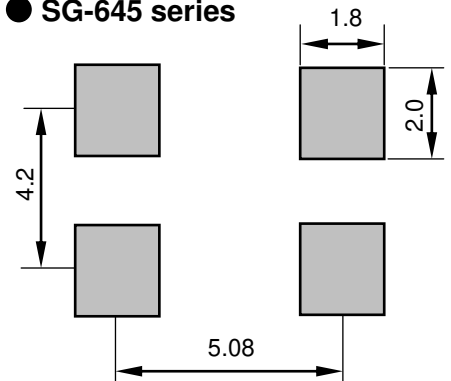

● SG-636 series

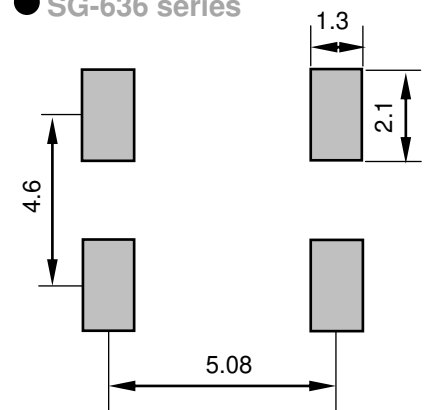

To maintain stable operation, provide a 0.01μF to 0.1μF by-pass capacitor at a location as near as possible to the power source terminal of the crystal product (between V_{cc} - GND).

PROMOTION OF ENVIRONMENTAL MANAGEMENT SYSTEM CONFORMING TO INTERNATIONAL STANDARDS

At Seiko Epson, all environmental initiatives operate under the Plan-Do-Check-Action (PDCA) cycle designed to achieve continuous improvements. The environmental management system (EMS) operates under the ISO 14001 environmental management standard.

All of our major manufacturing and non-manufacturing sites, in Japan and overseas, completed the acquisition of ISO 14001 certification.

ISO 14000 is an international standard for environmental management that was established by the International Standards Organization in 1996 against the background of growing concern regarding global warming, destruction of the ozone layer, and global deforestation.





WORKING FOR HIGH QUALITY

In order provide high quality and reliable products and services than meet customer needs,

Seiko Epson made early efforts towards obtaining ISO9000 series certification and has acquired ISO9001 for all business establishments in Japan and abroad. We have also acquired ISO/TS 16949 certification that is requested strongly by major automotive manufacturers as standard.

ISO/TS16949 is the international standard that added the sector-specific supplemental requirements for automotive industry based on ISO9001.

► Explanation of the mark that are using it for the catalog

	► Pb free.
	► Complies with EU RoHS directive. *About the products without the Pb-free mark. Contains Pb in products exempted by EU RoHS directive. (Contains Pb in sealing glass, high melting temperature type solder or other.)
	► Designed for automotive applications such as Car Multimedia, Body Electronics, Remote Keyless Entry etc.
	► Designed for automotive applications related to driving safety (Engine Control Unit, Air Bag, ESC etc).

Notice

- This material is subject to change without notice.
- Any part of this material may not be reproduced or duplicated in any form or any means without the written permission of Seiko Epson.
- The information about applied data, circuitry, software, usage, etc. written in this material is intended for reference only. Seiko Epson does not assume any liability for the occurrence of customer damage or infringing on any patent or copyright of a third party. This material does not authorize the licensing for any patent or intellectual copyrights.
- When exporting the products or technology described in this material, you should comply with the applicable export control laws and regulations and follow the procedures required by such laws and regulations.
- You are requested not to use the products (and any technical information furnished, if any) for the development and/or manufacture of weapon of mass destruction or for other military purposes. You are also requested that you would not make the products available to any third party who may use the products for such prohibited purposes.
- These products are intended for general use in electronic equipment. When using them in specific applications that require extremely high reliability, such as the applications stated below, you must obtain permission from Seiko Epson in advance.
/ Space equipment (artificial satellites, rockets, etc.) / Transportation vehicles and related (automobiles, aircraft, trains, vessels, etc.) / Medical instruments to sustain life / Submarine transmitters / Power stations and related / Fire work equipment and security equipment / traffic control equipment / and others requiring equivalent reliability.
- All brands or product names mentioned herein are trademarks and/or registered trademarks of their respective.