

YD5 Series Converter

Outline Diagram

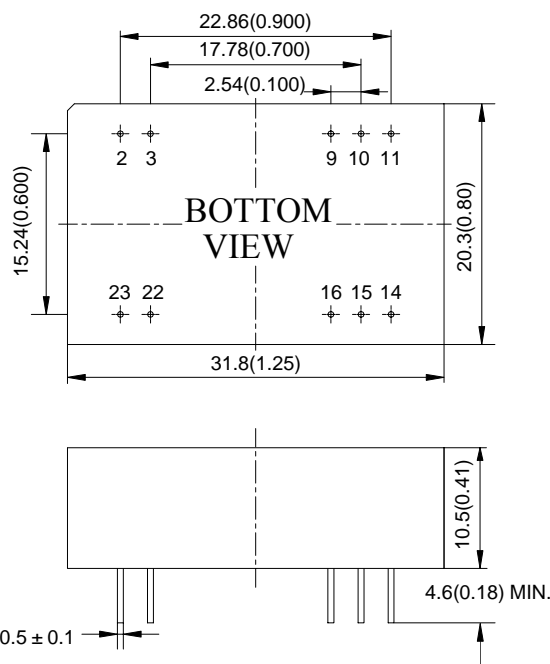

Features

- Small Size (31.8 mm×20.3 mm×10.5 mm)
- 500V_{dc} Isolation Voltage
- Operating Case Temp:-25 to 85
- Applications: Telecommunication equipments, data exchange servers and distributed power.

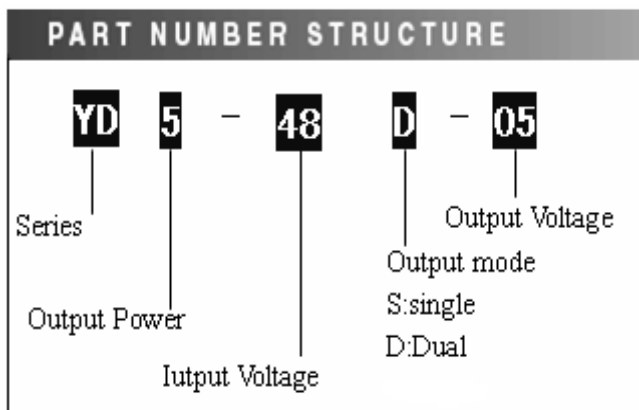

Pin	Single	Dual	Pin	Single	Dual
2	-Vin	-Vin	14	+Vo	Vo1
3	-Vin	-Vin	15	NC	NC
9	NC	COM	16	-Vo	COM
10	NC	NC	22	+Vin	+Vin
11	NC	Vo2	23	+Vin	+Vin

Case material : Aluminum,black;
 Pin: Copper, tin-cerium plating
 Notes: all dimensions in mm(inches)
 Tolerance: X.X±0.5(X.XX±0.02)
 X.XX±0.25(X.XXX±0.010)

Performance Specifications And Ordering Guide

Unless otherwise specified, all values are given at: 25 °C, one standard atmosphere pressure, pure resistive load and basic connection.

Model	Output				Input Range-DC (Volts)	Efficiency
	Voltage(V)	Current(A)	Ripple and Noise	Capacitive load(uF)		
YD5-12S05	5.05	1.0	50	2200	9~18	73%
YD5-24S05	5.05	1	50	2200	9~18	75%
YD5-24S12	12	0.42	100	470	18~36	78%
YD5-24S15	15	0.33	100	470	18~36	78%
YD5-48S05	5.05	1.0	50	3300	36~72	79%
YD5-48S12	12	0.42	100	470	36~72	80%
YD5-24D05	+5.05/ - 5.05	+0.5/ - 0.5	50/50	1000/1000	18~36	77%
YD5-24D15	+15/ - 15	+0.17/ - 0.17	100/100	220/220	18~36	79%
YD5-48D05	+5.05/ - 5.05	+0.5/ - 0.5	50/50	1000/1000	36~72	77%

Performance/Functional Specifications

Input		General	
Input Voltage:	See Ordering Guide	Isolation Voltage:	500Vdc 1min/5mA (Input-Output)
Output		Switchin Frequency:	300kHz(typ.)
Voltage Accuracy:	±1% Vo1 ±3% Vo2	MTBF :	2×10 ⁶ h(Bellcore RT332, 25)
Line Regulation:	±0.2%max. Vo1	Temperature Coefficient:	±0.02% per (Nom)
Load Regulation:	±0.5% max. Vo1	Case Temperature:	-25 ~ +85 (Industry)
Ripple and Noise:	50mVp-p Vo 5Vdc 100 mVp-p Other 200 mVp-p Vo 48Vdc	Storage Temperature:	-55 ~ +105
Efficiency:	See Ordering Guide	Relative Humidity:	10%~90%
Transient Response Recovery Time(μs):	See respective data sheet	Short-circuit Protection:	Hiccup mode, automatic recovery
Transient Response Voltage Deviation (%):	See respective data sheet	Isolation Resistance:	50 MΩmin(500Vdc , 90%RH)
Start-up Delay Time:	See respective data sheet	Manual Soldering:	425 max (5s Max)
Rise Time:	See respective data sheet	Wave Soldering:	260 max (10s Max)
		Weight:	10~12g

Characteristic Curves

Efficiency

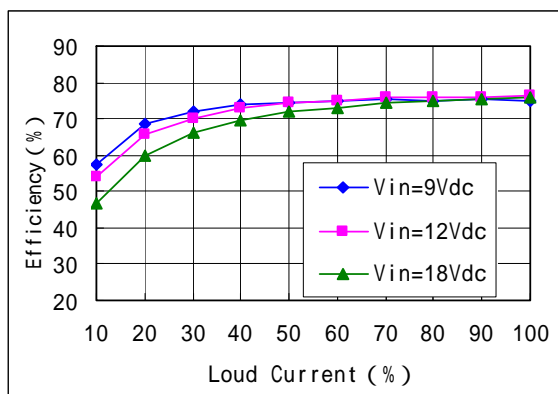

YD5-12S05

Efficiency

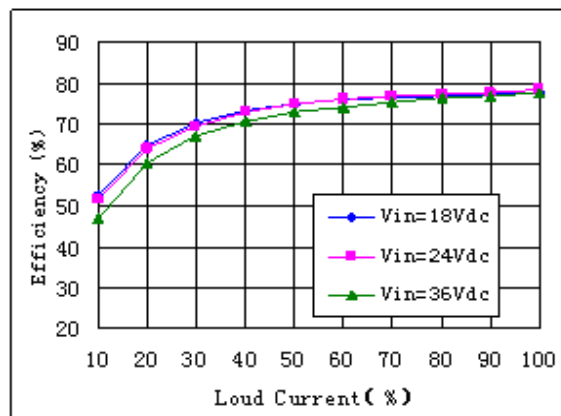

YD5-24S05

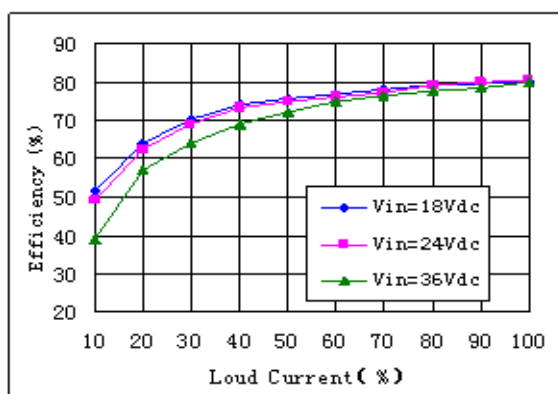

YD5-24S12

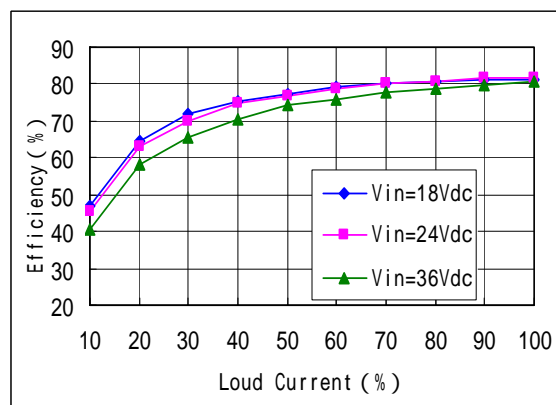

YD5-24S15

DC-DC Converter YD5 Series

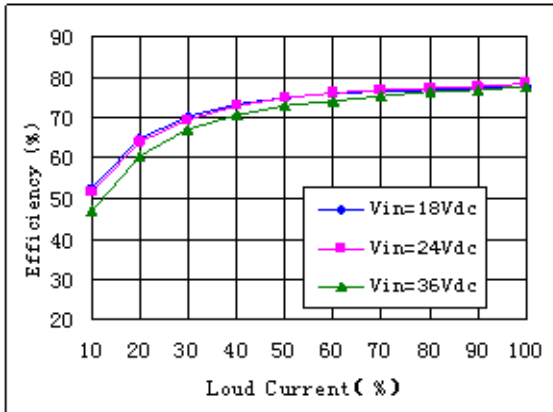

YD5-24D05

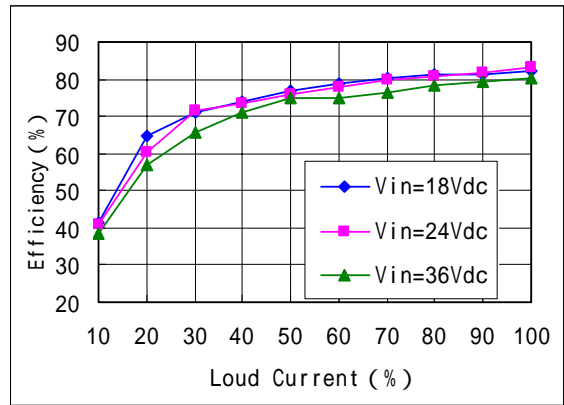

YD5-24D15

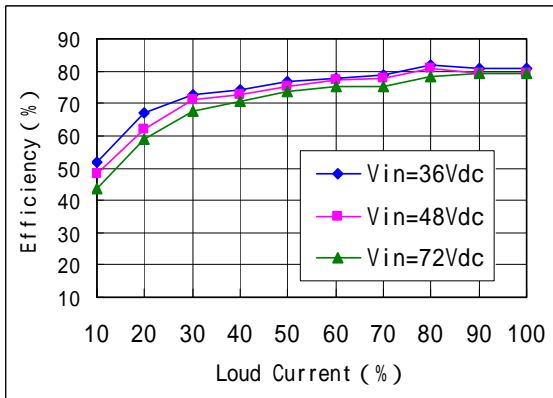

YD5-48S05

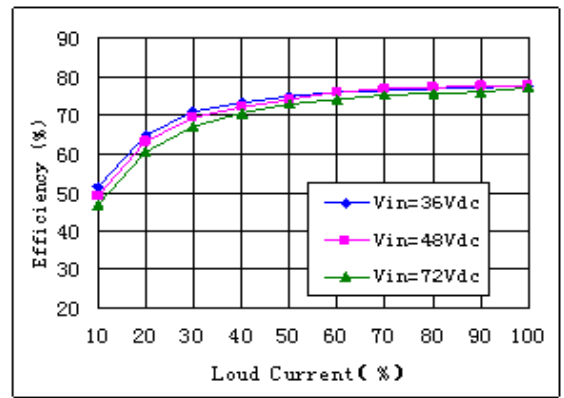

YD5-48S12

Derating

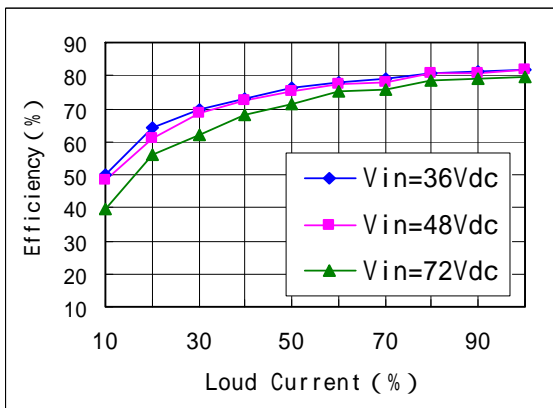

YD5-48D05

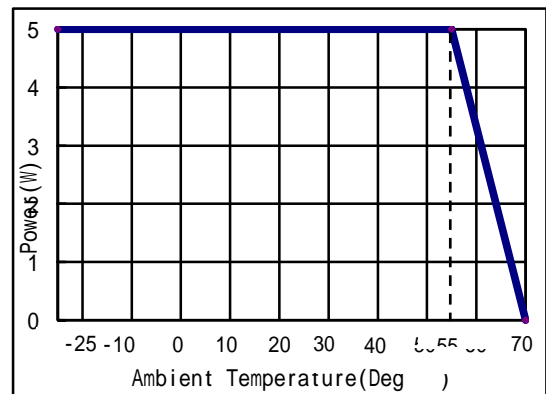

Design Considerations

Basic Connection

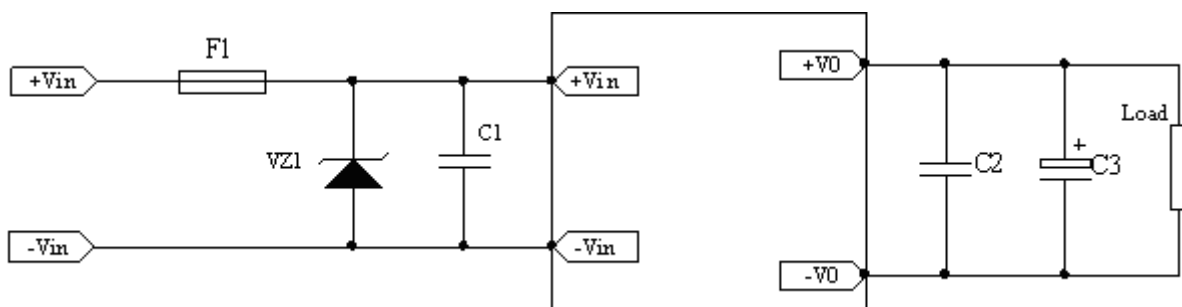

Notes :

1. Please refer to the respective data sheet for further information.
2. F1: fuse ; VZ1: TVS; C1:10μF~100μF , C2: 1μF~22μF ; C3: 10μF~1000μF。

Recommended Layout

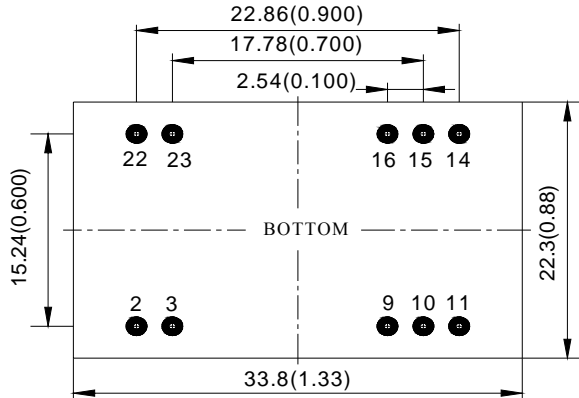

No.	Recommendation & Notes
Pad Design	Pad hole: 0.7mm, pad diameter including hole: 1.5mm.
Airflow Direction	The plastic case also is considered heat sink. Advised not to put flat surface down after mounted.
Safety	Isolated module, care to the spacing between input and output.
Electrical	The Vin(-) and Vo(-) planes should be placed under of the module separately. Avoid routing sensitive signal or high disturbance AC signal under the module.

External Capacitance

Unless special purpose (i.e. prolonging hold-up time, input impedance matching), the recommended input filter’s capacitance ranges 10μF to 100μF, which not only offers a stable system, and reduces the cost, but also lessens the inrush current when the power supplies.

When larger capacitance is required, a circuit of suppressing the inrush current is recommended when the regulator start-up and a discharge circuit is recommended when the output dropped, ensuring the reliability and safety of other equipments in the system.

Thermal Consideration

The converters operate in a variety of thermal environments; however, sufficient cooling should be provided to ensure reliable operation of the unit. Heat is removed by conduction, convection and radiation to the surrounding environment.

When ambient temperature is higher than the permitted operating, the derating curves should be

Series and Parallel Operation

The converters should not be paralleled directly to increase power, but they can be paralleled each other through o-ring switches or diodes. Make sure that every converter’s maximum load current should not exceed the rated current at anytime, if they are paralleled without using external current sharing circuits.

The converters can operate in series. To prevent against start-up failure due to start up time difference, SBD with low voltage difference can be paralleled at the output pins(SBD negative terminal connect to the positive pin of the output) for each converter.

referred or external heat dissipation measures. Forced air cooling or heatsink, should be used. The air tunnel should be considered for forced air cooling, to avoid heated air be hindered or forming swirl; when heatsink used, it should be attached the converter closely, through double-side thermal conductivity insulation adhesive or thermal conductivity silicone for heat exchange.

Safety Consideration

The module, as one component for the end user, should be installed into the equipment. It is required to meet safety requirements in the system design.

To avoiding fire and be protected when short circuit occurred, it is recommended that a fast blow fuse with rating 2.5 to 3 times of converter’s continuous input peak current is used in series at the input terminal.(Inrush current suppression circuit is required for greater filter capacitance at input terminal, or it will result in the misoperation of the fuse).

Cleaning Notice

The converter case is not a hermetically-sealed construction, a sufficient drying process is required after the converter cleaning, make sure the liquid congregated is removed, or it will damage the converter or degradation of performance

After surface treatment, the appearance of the converter may be affected by the organic solvent, protection measures should be taken before cleaning when appearance is concerned.

DC-DC Converter YD5 Series**Delivery Package Information**

Package material is multiple wall corrugated with less than $10^9 \Omega$ surface resistance ;internal material is anti-static foam with less than $10^5 \Omega$ surface resistance. Tray capacity: $2 \times 30 = 60$ PCS/box , Tray weight: 0.68~0.8kg ; Carton capacity: $15 \times 60 = 900$ PCS , Carton weight: 11.0 kg ~12.5kg.

Quality Statement

The converters are manufactured in accordance with ISO 9001 system requirements, in compliant with YD/T1376-2005, and are monitored 100% by auto-testing system, 100% burn in.

The warranty for the converters is 5-year.

Contact Information

Anhui Hesion Trading Co.,Ltd.
Add: Room1001,Zheshang Business Mansion,
No.103 Kexue Road, Hefei Anhui,China 230088
TEL: +86-551-5369069,5369067
FAX:+86-551-5369070
Email: alecz@ahhesion.com
Backup:alecz@126.com
Web: www.yihongtai.com