

1W, Wide input voltage, isolated & regulated output DC/DC converter

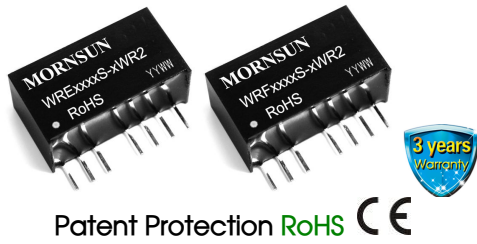

### FEATURES

- Ultra compact SIP package
- Wide input voltage range (2:1)
- Operating temperature range: -40°C to +85°C
- Isolation voltage: 3.0K VDC
- High power density
- Short circuit protection (self-recovery)
- Remote On/Off
- EN60950 approval

WRE\_S-1WR2 & WRF\_S-1WR2 series are isolated 1W DC-DC products with 2:1 input voltage and conventional voltage output. The product has a relatively compact SIP plastic package, and features high efficiency, operating temperature of -40 °C~+85 °C. The smaller size and fine cost design make the converter an ideal solution in communication, instruments, and industrial electronics applications.

### Selection Guide

Certification	Part No.	Input Voltage (VDC)		Output		Ripple&noise (Typ./Max. mVp-p)	Efficiency (% Min./Typ.) @ Full Load	Max. Capacitive Load <sup>②</sup> (μF)
		Nominal (Range)	Max. <sup>①</sup>	Output Voltage(VDC)	Output Current (mA)(Max./Min.)			
CE	WRE0505S-1WR2	5 (4.5-9)	11	±5	±100/±5	70/100	71/73	1000
	WRE0512S-1WR2			±12	±42/±2		74/76	470
	WRE0515S-1WR2			±15	±33/±2		73/75	330
	WRF0505S-1WR2			5	200/10		70/72	2200
	WRF0512S-1WR2			12	83/4		74/76	1000
	WRF0515S-1WR2			15	67/3		73/75	680
	WRE1205S-1WR2	12 (9-18)	20	±5	±100/±5	100/150	76/78	1000
	WRE1212S-1WR2			±12	±42/±2		79/81	470
	WRE1215S-1WR2			±15	±33/±2		76/78	330
	WRF1203S-1WR2			3.3	303/15		73/75	2700
	WRF1205S-1WR2			5	200/10		75/77	2200
	WRF1209S-1WR2			9	111/6		77/79	1800
	WRF1212S-1WR2	12	83/4	77/79	1000			
	WRF1215S-1WR2	15	67/3	78/80	680			
	WRE2405S-1WR2	24 (18-36)	40	±5	±100/±5	70/100	77/79	1000
	WRE2412S-1WR2			±12	±42/±2		77/79	470
	WRE2415S-1WR2			±15	±33/±2		77/79	330
	WRF2403S-1WR2			3.3	303/15		73/75	2700
	WRF2405S-1WR2			5	200/10		75/77	2200
	WRF2412S-1WR2			12	83/4		76/78	1000
	WRF2415S-1WR2	15	67/3	76/78	680			
	WRF2424S-1WR2	24	42/2	75/77	470			
	WRE4805S-1WR2	48 (36-75)	80	±5	±100/±5	100/150	74/76	1000
	WRE4812S-1WR2			±12	±42/±2		76/78	470
WRE4815S-1WR2	±15			±33/±2	78/80		330	
WRF4803S-1WR2	3.3			303/15	73/75		2700	
WRF4805S-1WR2	5			200/10	74/76		2200	
WRF4812S-1WR2	12			83/4	78/80		1000	
WRF4815S-1WR2	15	67/3	77/79	680				

Notes: ① Exceeding the maximum input voltage may cause permanent damage;

② For the dual output modules, the capacitive loads of positive and negative outputs are the same.

### Input Specifications

Item	Operating Conditions	Min.	Typ.	Max.	Unit
Input Current (full load/no-load)	5VDC Input	--	278/40	286/60	mA
	12VDC Input	--	107/15	110/30	
	24VDC Input	--	54/6	55/10	
	48VDC Input	--	27/4	28/6	
Reflected Ripple Current	5VDC Input	--	30	--	mA
	12VDC Input	--	40	--	
	24VDC Input	--	55	--	
	48VDC Input	--	45	--	
Input Impulse Voltage (1sec. max.)	5VDC Input	-0.7	--	12	VDC
	12VDC Input	-0.7	--	25	
	24VDC Input	-0.7	--	50	
	48VDC Input	-0.7	--	100	
Starting Voltage	5VDC Input	3.5	4	4.5	VDC
	12VDC Input	4.5	8	9	
	24VDC Input	11	16	18	
	48VDC Input	24	33	36	
Input Filter		Filter capacitor			
Hot Plug		Unavailable			
Ctrl*	Module turn-on	The Ctrl end is suspended or of high resistance			
	Module turn-off	Connect with high level (relative to the input grounding) to make the 5-10mA current flows into the Ctrl end.			

Note: \* For use of Ctrl, please refer to the "design reference" in this manual.

### Output Specifications

Item	Operating Conditions	Min.	Typ.	Max.	Unit	
Output Voltage Accuracy	5%-100% load	3.3V/5V output	--	±3	±5	%
		others	--	±1	±3	
No-load Output Voltage Accuracy	Input voltage range	--	±1.5	±5		
Balance of Output Voltage	Dual output, balanced load	--	±0.3	±0.5		
Line Regulation	Full load, the input voltage is from low to high	--	±0.2	±0.5		
Load Regulation	5%-100% load	--	±0.4	±0.75		
Transient Recovery Time	25% load step change	--	0.5	2	ms	
Transient Response Deviation		--	±2.5	±5	%	
Temperature Coefficient	Full load	--	±0.02	±0.03	%/°C	
Ripple & Noise *	20MHz bandwidth	See Selection Guide				
Short Circuit Protection		Continuous, self-recovery				

Note: \*Ripple and noise are measured by "parallel cable" method, please see DC-DC Converter Application Notes for specific operation.

### General Specifications

Item	Operating Conditions	Min.	Typ.	Max.	Unit
Isolation Voltage	Input-output, with the test time of 1 minute and the leak current lower than 1mA	3000	--	--	VDC
Isolation Resistance	Input-output, isolation voltage 500VDC	1000	--	--	MΩ
Isolation Capacitance	Input-output, 100KHz/0.1V	--	30	50	pF
Operating Temperature	Derating if the temperature ≥85°C, (see Fig. 1)	-40	--	+85	°C
Storage Temperature		-55	--	+125	
Casing Temperature Rise	Ta=25°C, nominal input, full load output	--	+25	--	
Pin Welding Resistance Temperature	Welding spot is 1.5mm away from the casing, 10 seconds	--	--	+300	

Storage Humidity	Non-condensing	--	--	95	%RH
Switching Frequency (PFM Mode)	Full load, nominal input voltage	--	200	--	KHz
MTBF	MIL-HDBK-217F@25°C	1000	--	--	K hours

Physical Specifications

Casing Material	Black flame-retardant and heat-resistant plastic (UL94-V0)
Dimension	22.00*9.50*12.00 mm
Weight	4.90g(Typ.)
Cooling Method	Free convection

EMC Specifications

EMI	CE	CISPR22/EN55022	CLASS B (see Fig. 3-② for recommended circuit)
	RE	CISPR22/EN55022	CLASS B (see Fig. 3-② for recommended circuit)
EMS	ESD	IEC/EN61000-4-2	Contact ±4KV perf. Criteria B
	RS	IEC/EN61000-4-3	10V/m perf. Criteria A
	EFT	IEC/EN61000-4-4	±2KV (see Fig. 3-① for recommended circuit) perf. Criteria B
	Surge	IEC/EN61000-4-5	±2KV (see Fig. 3-① for recommended circuit) perf. Criteria B
	CS	IEC/EN61000-4-6	3 Vr.m.s perf. Criteria A
	Voltage dips, short interruptions and voltage variations immunity	IEC/EN61000-4-29	0%-70% perf. Criteria B

Product Characteristic Curve

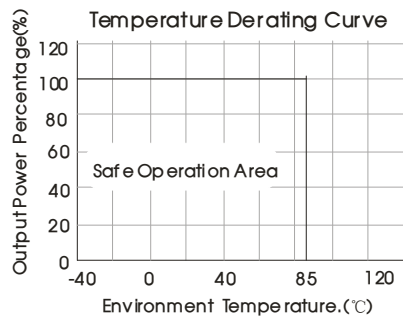
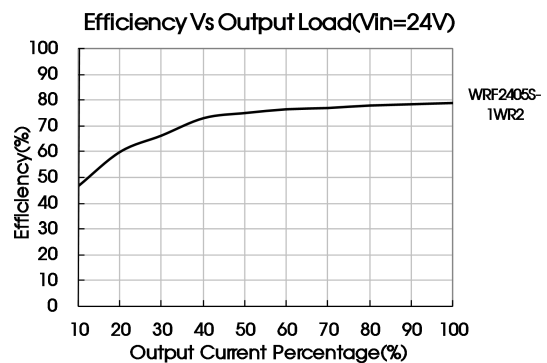
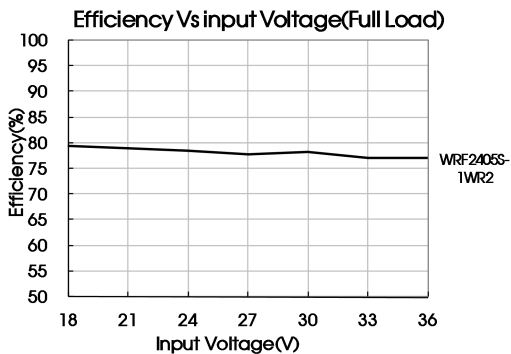
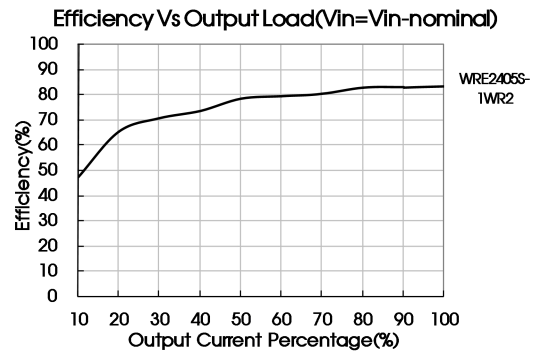
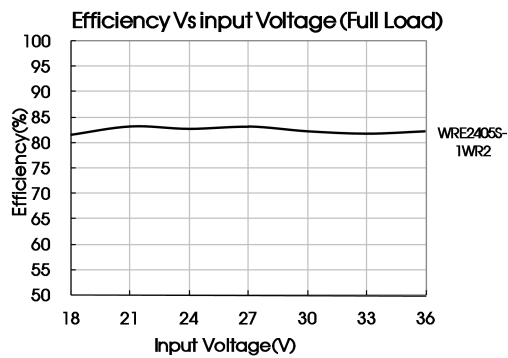

Fig 1



Design Reference

1. Recommended circuit

All the DC/DC converters of this series are tested according to the recommended circuit (see Fig. 2) before delivery. If a further decrease of the input and output ripple is required, properly increase the input & output of additional capacitors Cin1, Cin2, Cs and Cout; or select capacitors of low equivalent impedance like series capacitor, etc. Cs is used to reduce ripple. No need to add Cs, if ripple meets the demand. Appropriate filter capacitance shall be chosen, start-up problems may be caused if the capacitance is too large. For each output circuit, under the condition of safe and reliable operation, the max. capacity of its filter capacitor should be lower than the max. capacitive load.

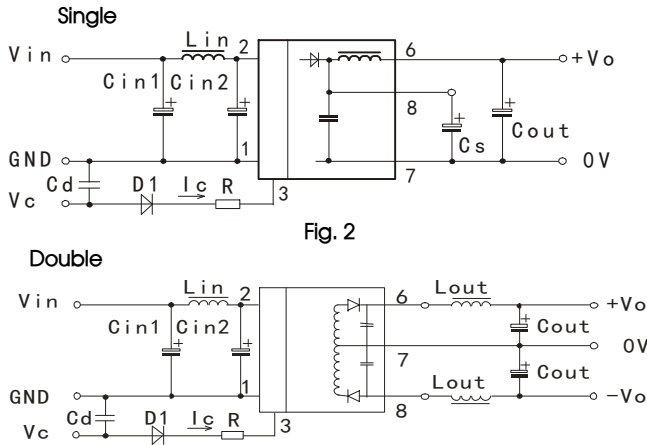

Fig. 2

Pin	5VDC&12VDC	24VDC&48VDC
Cin1	100µF	10µF
Cin2	47µF	1µF
Lin	4.7µH~12µH	
Cs	10µF~22µF	
Cout	100µF(Typ.)	
Cd	47nF/100V	

2. EMC solution-recommended circuit

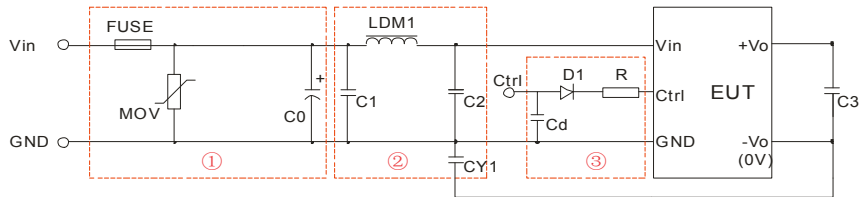

Fig. 3

Parameter description:

Model	Vin:5VDC	Vin:12VDC	Vin:24VDC	Vin:48VDC
FUSE	Slow blown fuses according to the actual input current selections of the clients			
MOV	--	--	S14K35	S14K60
LDM1	--	--	56 µ H	56 µ H
C0	680µF/16V	680µF/25V	330µF/50V	330µF/100V
C1	4.7µF/50V			4.7µF/100V
C2	4.7µF/50V			4.7µF/100V
C3	Refer to the Cout in Fig.2			
CY1	1nF/3KV			
D1	RB160M-60/1A			
R	In accordance with the formula: $R = \frac{V_c - V_D - 1.0}{I_c} - 300$			
Cd	47nF/100V			

Notes:

- ① Part ① in Fig. 3 is used for EMS test while part ② is used for EMI filtering; and parts ① and ② may be selected based on needs.
- ② Vc is the voltage of the Ctrl end relative to the GND of the input grounding; V<sub>D</sub> is the positive-going conduction pressure drop of D1; I<sub>c</sub> is the current flows into the Ctrl end and its value is generally 5-10mA, see Fig. 3-③ for the peripheral circuit of Ctrl end;
- ③ If there is no recommended parameters, no external component is required.

### 3. Ctrl end

The modules are of normal output when the Ctrl end is suspended or of high resistance; the modules turn off when connecting with high level (relative to the input grounding); notice that the current flows into the pin shall be 5 - 10mA, the modules will be permanently damaged if the current exceeds its max. value (20mA in general).

The value of R can be derived as follows:

$$R = \frac{V_c - V_D - 1.0}{I_c} - 300$$

For Detailed parameter, please refer to EMC solution-recommended circuit in this manual.

### 4. Input current

When the electricity is provided by the unstable power supply, please make sure that the range of the output voltage fluctuation and the ripple voltage of the power supply do not exceed the indicators of the modules. Input current of power supply should afford the flash startup current of this kind of DC/DC module(see Fig. 5).

Generally: Vin= 5V series Iave =445mA  
 Vin=12V series Iave =205mA  
 Vin=24V series Iave =104mA  
 Vin=48V series Iave =53mA

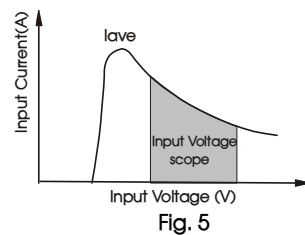

Fig. 5

### 5. Output load requirements

When using, the minimum load of the module output should not be less than 5% of the nominal load. In order to meet the performance parameters of this datasheet, please connect a 5% dummy load in parallel at the output end, the dummy load is generally a resistor, please note that the resistor needs to be used in derating.

6. For more information please find DC-DC converter application notes on [www.mornsun-power.com](http://www.mornsun-power.com)

## Dimensions and Recommended Layout

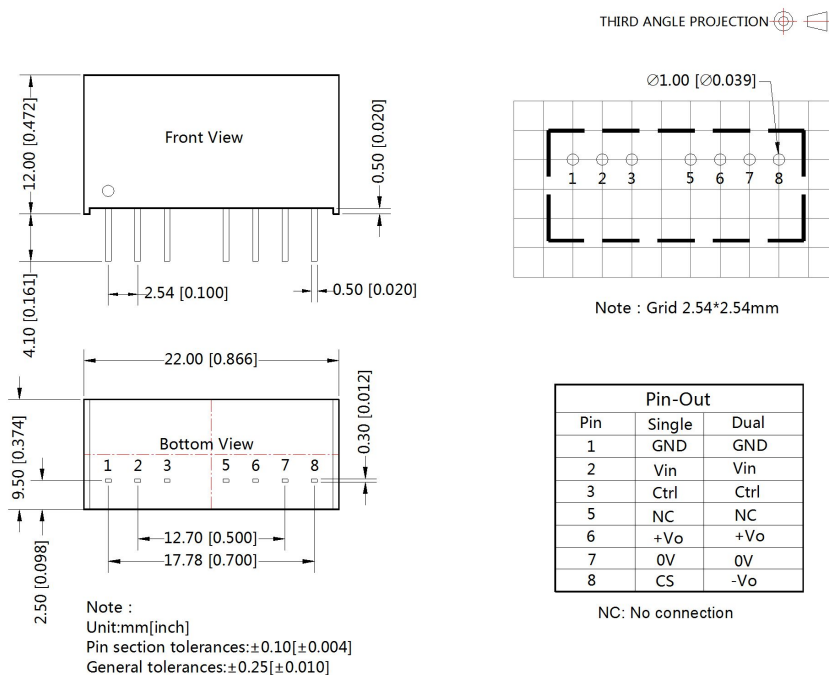

Notes:

1. Packing information please refer to Product Packing Information which can be downloaded from [www.mornsun-power.com](http://www.mornsun-power.com). Packing bag number: 58210004;
2. Recommend to use module with more than 5% load, if not, the ripple of the product may exceeds the specification, but does not affect the reliability of the product;
3. The recommended unbalance degree of the dual output module load is  $\leq \pm 5\%$ ; if the degree exceeds  $\pm 5\%$ , than the product performance cannot be guaranteed to comply with all parameters in the datasheet. Please contact our technicians directly for specific information;
4. The maximum capacitive load offered were tested at nominal input voltage and full load;
5. Unless otherwise specified, parameters in this datasheet were measured under the conditions of  $T_a=25^\circ\text{C}$ , humidity $<75\%$  with nominal input voltage and rated output load;
6. All index testing methods in this datasheet are based on Company's corporate standards;
7. The performance parameters of the product models listed in this manual are as above, but some parameters of non-standard model products may exceed the requirements mentioned above. Please contact our technicians directly for specific information;
8. We can provide product customization service;
9. Specifications are subject to change without prior notice.

MORNSUN Guangzhou Science & Technology Co., Ltd.

Address: No. 5, Kehui St. 1, Kehui Development Center, Science Ave., Guangzhou Science City, Luogang District, Guangzhou, P. R. China  
Tel: 86-20-38601850-8801 Fax: 86-20-38601272 E-mail: info@mornsun.cn