

WIZ200WEB

User's Manual (Ver. 1.0)



©2007 WIZnet Inc. All Rights Reserved.

For more information, visit our website at www.wiznet.co.kr

Document History Information

Revision	Date	Description
Ver. 1.0	2008. 12.	Release with WIZ200WEB launching

WIZnet's Online Technical Support

If you have any questions or want more information about WIZnet products, submit your question to the Q&A Board on the WIZnet website.(www.wiznet.co.kr) A WIZnet engineer will have an answer for you as soon as possible.

The screenshot shows the WIZnet website interface. At the top, there is a navigation menu with links for Home, Sitemap, Contact us, and 한국어. Below this is a secondary menu with links for Products, Technology, Technical Q & A, Library, Where to buy, Value Chain, and About us. The main content area features a large banner for the W5100 chip, described as a '3 in 1' solution for embedded Internet, consisting of TCP/IP Core, MAC, and PHY. To the right, there is a section for 'New Products' featuring the WIZ100SR Serial-to-Ethernet module. Below the banner, there are three main sections: 'Application Reference' with a list of projects like Solar Cell Inverter and Mobile Base Station; 'Solution Provider' with products like Single Board Computer plus Ethernet and Evaluation Board; and 'WIZnet News' with recent news items. A large blue arrow labeled 'Click !!' points to the 'Technical Support' link in the bottom right navigation area. The footer contains copyright information for WIZnet Inc. and logos for NEC, AMTEL, and MICROCHIP.

Table of Contents

1. Introduction	7
1.1. Main Function.....	7
1.2. Specification	8
1.3. Contents (WIZ200WEB-EVB).....	8
2. Block Diagram	9
3. WIZ200WEB Base Board.....	11
4. Getting Started.....	16
4.1. Configuration Tool.....	16
4.1.1. Basic Configuration	16
4.1.2. Firmware Upload	17
4.1.3. Webpage Upload	19
4.1.4. Use of Rom File Maker rev3.0.....	20
4.2. Operation Test.....	22
4.2.1. Hardware Interface	22
4.2.2. Testing the Function of Web Server.....	23
5. Programmer's Guide	26
5.1. Memory Map.....	26
5.2. WIZ200WEB Firmware.....	26
5.3. Compile.....	28
5.4. Downloading.....	28
6. WIZ200WEB Hardware Specification	31
6.1. Parameters	31
6.2. Specification	31
6.3. Board Dimensions and Pin Assignment.....	31
6.3.1. Pin Assignment	31
6.3.2. Size	32
6.3.3. Connector Specification.....	33
7. Warranty	35

Tables

Table 1. WIZ200WEB Specification.....	8
Table 2. Contents of WIZ200WEB.....	9
Table 3. WIZ200WEB PIN MAP.....	12
Table 4. Expansion Connector.....	15
Table 5. WIZ200WEB Testing Environment.....	22
Table 6. WIZ200WEB Main Source.....	27
Table 7. WIZ200WEB PINMAP.....	31

Figures

Figure 1. Block Diagram	10
Figure 2. WIZ200WEB Base Board Layout	11
Figure 3. AVR JTAG Connector.....	12
Figure 4. AVR ISP Connector.....	12
Figure 5. WIZ200WEB PIN MAP.....	12
Figure 6. WIZ200WEB LED.....	13
Figure 7. WIZ200WEB Switch	13
Figure 8. WIZ200WEB 16x2 LCD	14
Figure 9. WIZ200WEB VR.....	14
Figure 10. WIZ200WEB Temperature Sensor	15
Figure 11. Configuration Tool	16
Figure 12. Board Search Window	18
Figure 13. Open dialog box for uploading	19
Figure 14. Firmware uploading window	19
Figure 15. Complete Uploading	19
Figure 16. Flash Rom Image File.....	20
Figure 17. ROM File Maker	21
Figure 18. ROM Image File Make.....	21
Figure 19. WIZ200WEB External Interface.....	22
Figure 20. WIZ200WEB index page	23
Figure 21. WIZ200WEB Digital Output Page	24
Figure 22. WIZ200WEB Digital Input Page.....	24
Figure 23. WIZ200WEB Analog Input Page.....	25
Figure 24. WIZ200WEB Memory Map.....	26
Figure 25. AVR Studio	28
Figure 26. ATmega128 ISP	29
Figure 27. WIZ200WEB Boot Loader Program.....	30
Figure 28. WIZ200WEB Pin Map.....	31
Figure 29. WIZ200WEB Module Dimension	32
Figure 30. WIZ200WEB Base Board Size.....	33
Figure 31. RJ-45 PIN Assignment.....	33
Figure 32. RJ-45 PIN Assignment.....	34
Figure 34. RS-232 PIN Assignment.....	34

1. Introduction

WIZ200WEB provides the tiny embedded web server operating on low-speed MCU. It controls digital output or monitors digital and analogue input through web browser. The webpage is stored in the serial flash memory of the board, and can be updated through network.

1.1. Main Function

- Operates as HTTP Server
- Guarantee system stability and reliability by using W5300, the hardwired chip
- Provides Configuration Tool Program for easy control and configuration
- Supports 10/100 Mbps Ethernet
- RoHS Compliant

1.2. Specification

ITEM	Description
MCU	ATmega128 (having internal 128K Flash, 4K SRAM, 4K EEPROM, external 32K SRAM, 512K Serial Flash)
Protocols	TCP/IP - W5300 (Ethernet MAC & PHY Embedded) UDP – Configuration HTTP Server DHCP
Network Interface	10/100 Mbps Auto-sensing, RJ-45 Connector
Input Voltage	DC 5V
Power Consumption	Under 180mA
Temperature	0°C ~ 80°C (Operation), -40°C ~ 85°C (Storage)
Humidity	10 ~ 90%

Table 1. WIZ200WEB Specification

1.3. Contents (WIZ200WEB-EVB)

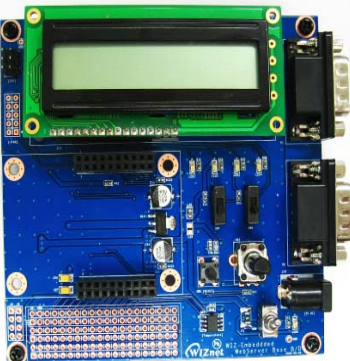
	<p>WIZ200WEB Module</p>
	<p>WIZ200WEB Base Board</p>

	<p>CD (Configuration Tool Program, Firmware, Manual are included)</p>
	<p>LAN Cable</p>
	<p>5V Power Adaptor</p>

Table 2. Contents of WIZ200WEB

☞ If any missing item is found, contact to the shop you purchased.

2. Block Diagram

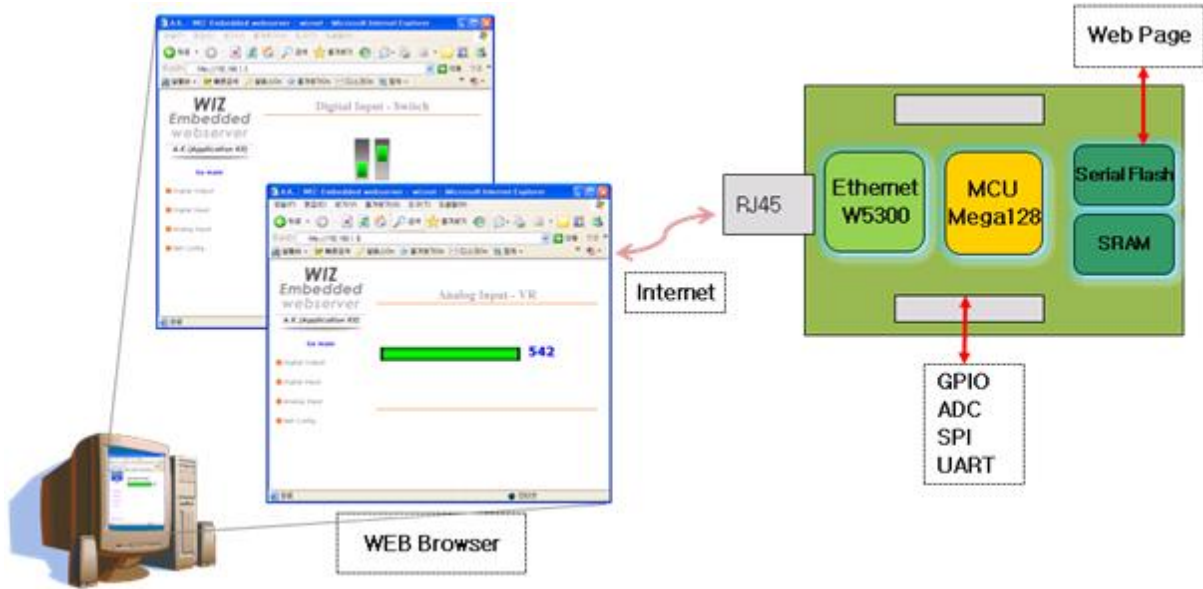
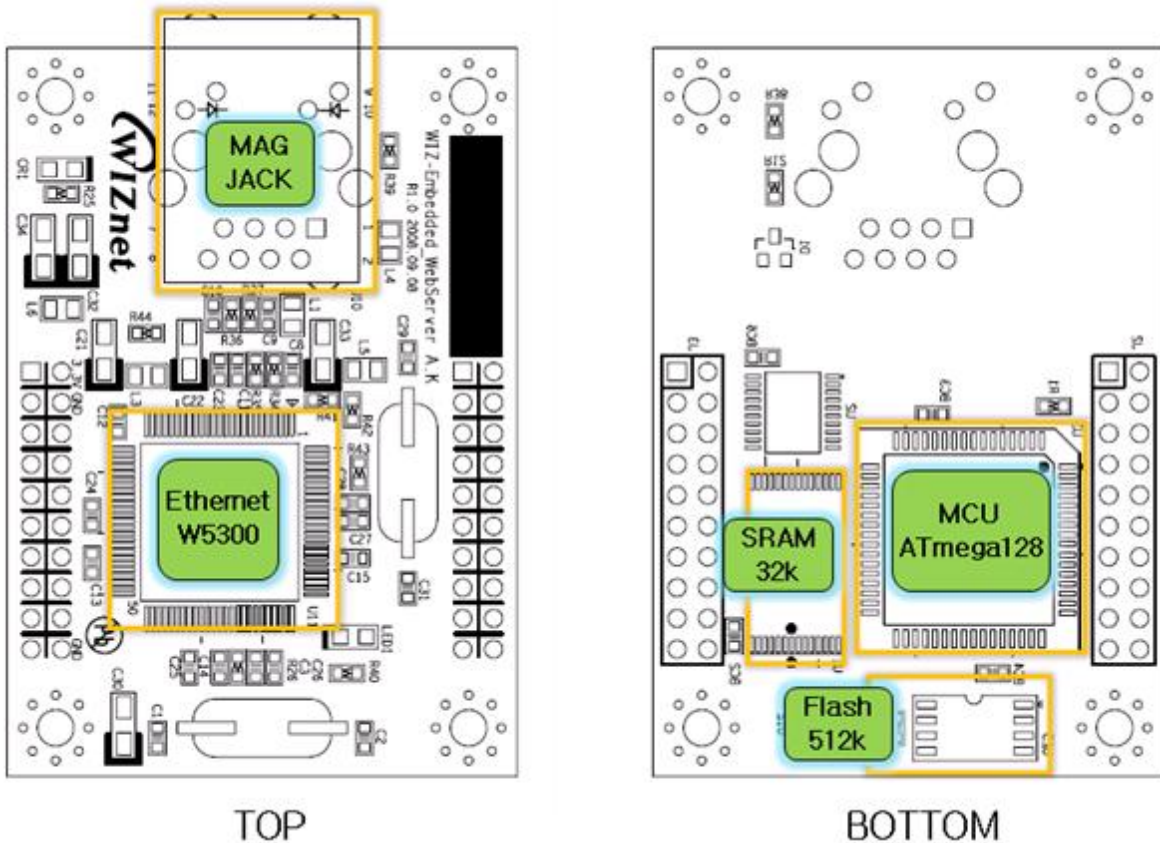

Figure 1. Block Diagram

The main MCU of WIZ200WEB is 8 bit AVR (ATmega128). The Ethernet is processed by W5300, the hardwired TCP/IP chip. When connected to the IP address of the board at the web browser, the webpage in the serial flash memory is transmitted and displayed. Each webpage enables control of digital input & output, analogue input and network configuration on the web.



3. WIZ200WEB Base Board

WIZ200WEB module can be tested by using base board.

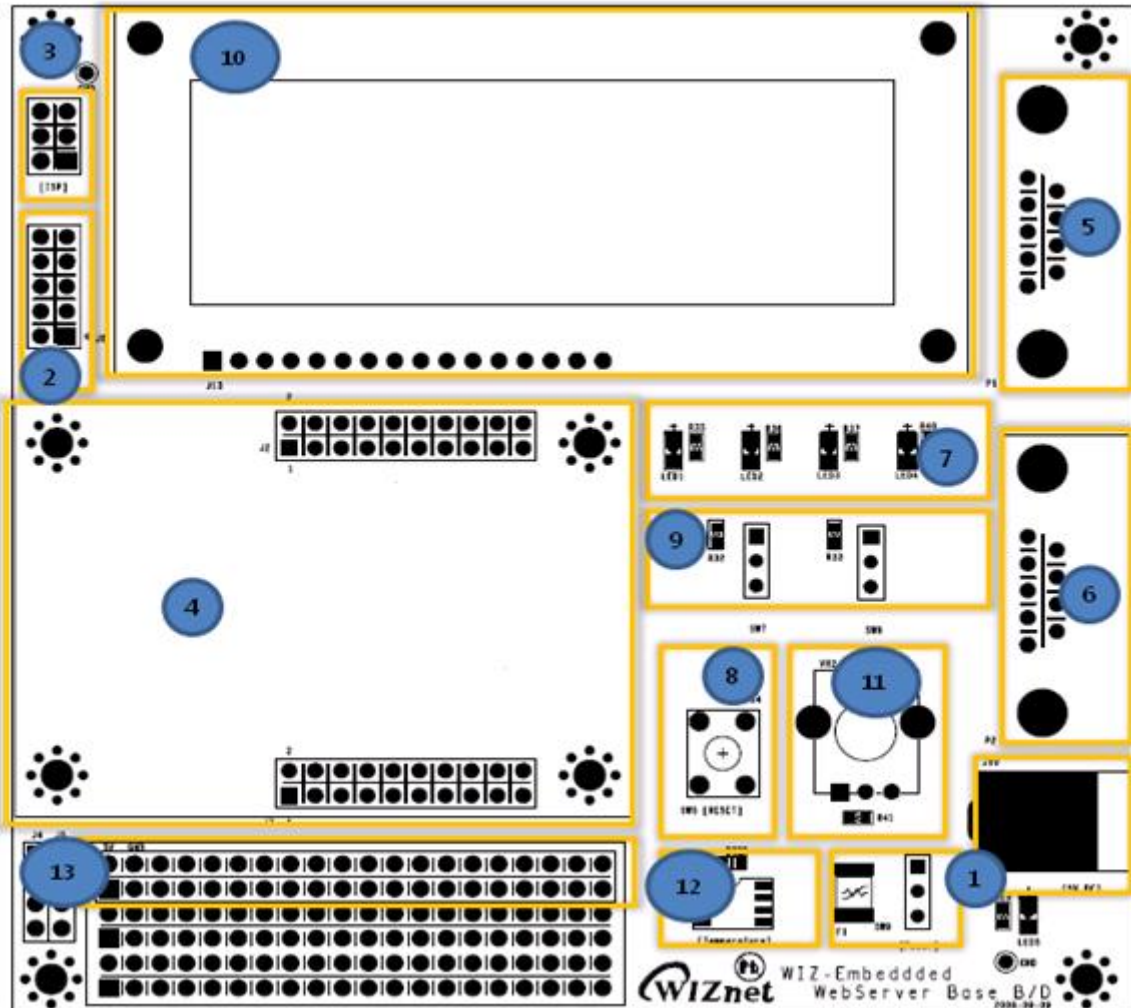

11

Figure 2. WIZ200WEB Base Board Layout

① Power

The power can be controlled by using power switch after connecting the DC 5V (500mA) adaptor.



② ATmega128 JTAG Connector

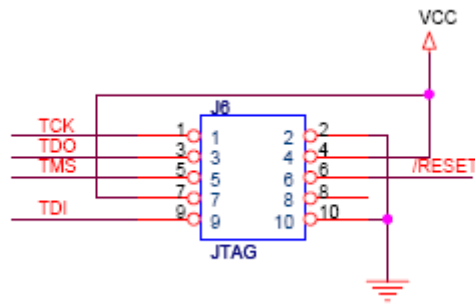

Figure 3. AVR JTAG Connector

③ ATmega128 ISP Connector

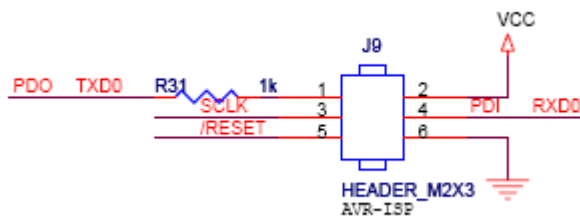

Figure 4. AVR ISP Connector

④ WIZ200WEB Module Connector

The connector has below pin map.

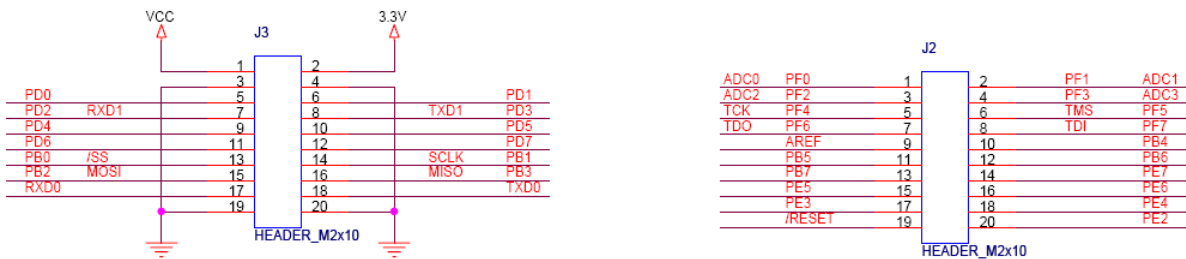

Figure 5. WIZ200WEB PIN MAP

J3		J2	
3.3V	3.3V	ADC0/PF0	ADC1/PF1
GND	GND	ADC2/PF2	ADC3/PF3
SCL/INT0/PD0	SDA/INT0/PD1	ADC4/PF4	ADC5/PF5
RXD1/INT2/PD2	TXD1/INT3/PD3	ADC6/PF6	ADC7/PF7
ICP1/PD4	XCK1/PD5	AREF	PB4
T1/PD6	T2/PD7	PB5	PB6
SS/PB0	SCK/PB1	PB7	PE7
MOSI/PB2	MISO/PB3	PE5	PE6
RXD0/PE0	TXD0/PE1	PE3	PE4
GND	GND	/RESET	PE2

Table 3. WIZ200WEB PIN MAP

⑤ Serial Connector(UART0)

The debugging information is transmitted through Serial connector when proceeding development.

⑥ Serial Connector(UART1)

The debugging information is transmitted through Serial connector when proceeding development.

⑦ LED

4 LEDs are installed in the WebServer Base Board, and connected to PORTB.4~7.

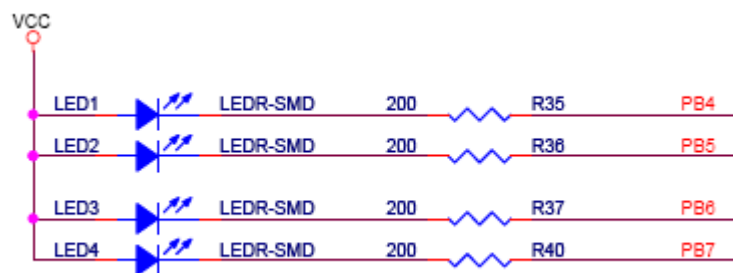

Figure 6. WIZ200WEB Base Board LED

⑧ System Reset Switch

⑨ Switch

Switch is connected to PORTE.5~6. It is the slide switch.

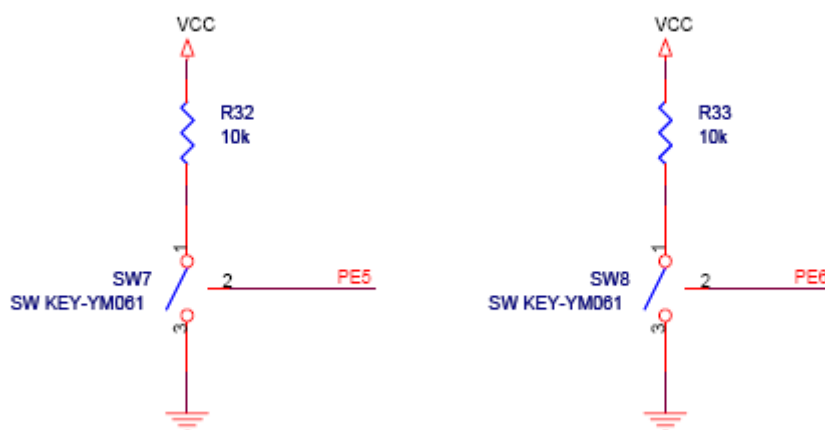

Figure 7. WIZ200WEB Base Board Switch

⑩ 16X2 character LCD

16x2 LCD is controlled with the method of 4 bit control It is connected to PORTD and

PORTE.

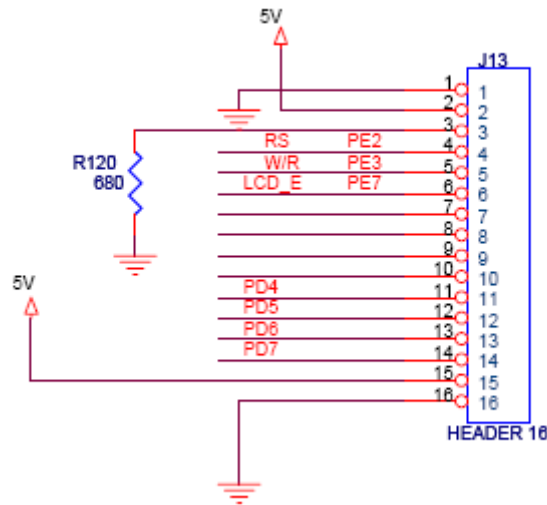

Figure 8. WIZ200WEB Base Board 16x2 LCD

⑪ Variable Resistor

In order to test the analog data easily, you can use variable resistor and get the input value of analog variable. Variable resistor is connected to ADC0 channel.

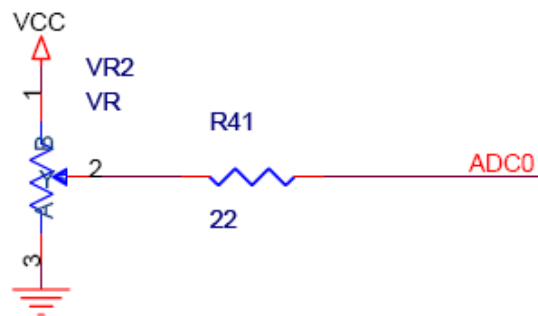

Figure 9. WIZ200WEB Base Board VR

⑫ Digital Temperature Sensor

Microchip's TC77 having 12bit resolutions is used for temperature sensor. Temperature sensor can be controlled by SPI and selected through PB0.

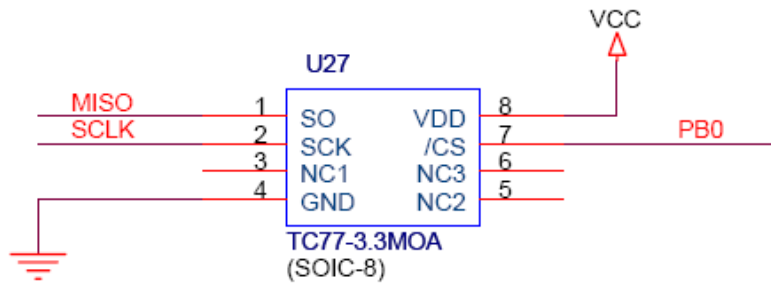

Figure 10. WIZ200WEB Base Board Temperature Sensor

⑬ Extension Connector

It is the connector (J12) to extend to GPIO and the function pins of ATmega128

NO	FUNCTION	NO	FUNCTION
1	NC	2	5V
3	NC	4	GND
5	SCL/INT0/PD0	6	ADC0/PF0
7	SDA/INT0/PD1	8	ADC1/PF1
9	RXD1/INT2/PD2	10	ADC2/PF2
11	TXD1/INT3/PD3	12	ADC3/PF3
13	ICP1/PD4	14	ADC4/PF4
15	XCK1/PD5	16	ADC5/PF5
17	T1/PD6	18	ADC6/PF6
19	T2/PD7	20	ADC7/PF7
21	SS/PB0	22	AREF
23	SCK/PB1	24	PE7
25	MOSI/PB2	26	PB6
27	MISO/PB3	28	PE5
29	PB4	30	PE4
31	PB5	32	PE3
33	PB6	34	PE2
35	PB7	36	/RESET
37	PE1/TXD0	38	NC
39	PE0/RXD0	40	NC

Table 4. Expansion Connector

4. Getting Started

4.1. Configuration Tool

4.1.1. Basic Configuration

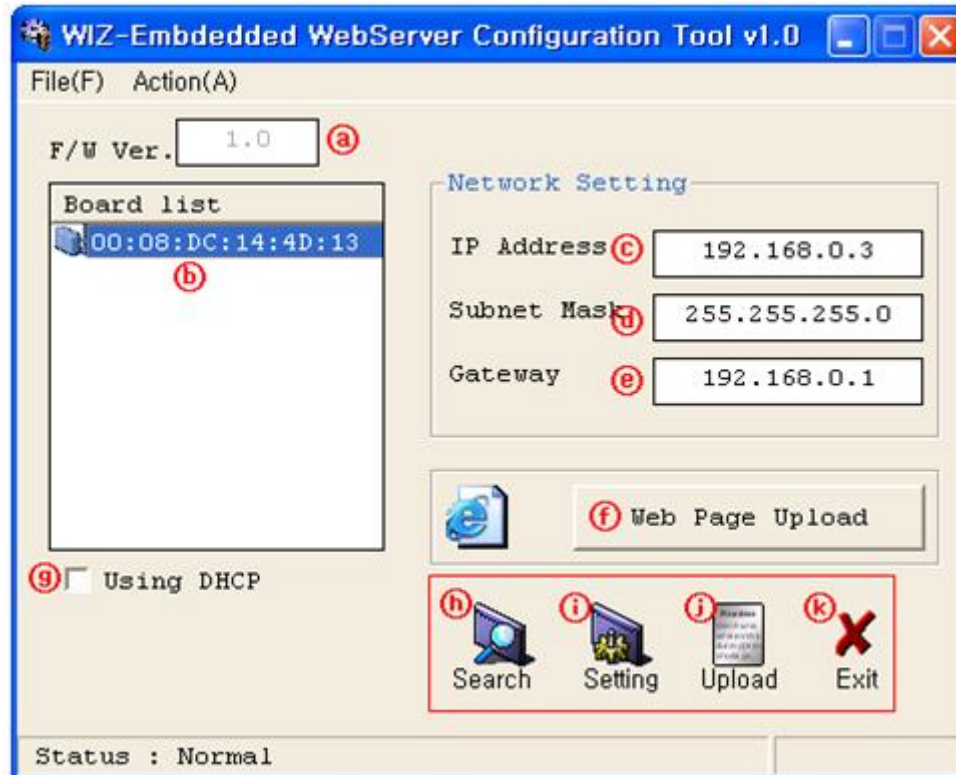

Figure 11. Configuration Tool

- Ⓐ Version : It displays Firmware version.
- Ⓑ Board List : If "Search" button is clicked, all MAC address of WIZ200WEB modules are displayed in the Board List.
- Ⓒ Local IP/Port : IP Address of WIZ200WEB
- Ⓓ Subnet : Subnet Mask of WIZ200WEB
- Ⓔ Gateway : Gateway Address of WIZ200WEB
- Ⓕ Web Page Upload : It is possible to upload ROM Image file to the internal flash memory of WIZ200WEB. For the detail, refer to "4.1.3. Webpage Upload".
- Ⓖ Enable DHCP Mode : It is the option for DHCP mode. Select a MAC Address to be used for

'Enable DHCP mode' at the 'board list'. If you click "Setting" button, the board acquires IP and Subnet Mask by using DHCP. (By acquiring IP address from DHCP server, it can take some time) After acquiring network information from DHCP, re-booting is processed. If you click "Search" button again, you can check changed values. If you click MAC Address on the 'Board list', IP Address, Subnet Mask and Gateway information are displayed. If network information is not acquired due to any problem, IP, Subnet and Gateway Address are initialized to 0.0.0.0.

㉞ Search : "Search" function is used for searching module on the same LAN. If all the modules on the same subnet are searched by using UDP broadcast, their MAC addresses are displayed on the "Board List".

㉟ Setting

This function is used for changing the configuration values of WIZ200WEB. After changing any configuration value, "Setting" button should be clicked for applying the value. With this, the values can be saved in the EEPROM and maintained even after shutting down the power of module.

The process is as below.

- ① Select a MAC address at the "Board list". The configuration values of selected module are displayed in each field.
- ② Change the value of each field.
- ③ If you click "Setting" button, the configuration is completed.
- ④ The module is initialized with the changed configuration. (automatically re-booted)
- ⑤ In order to check changed value, search the module with "Search" button.

㊱ Upload

Firmware is uploaded through network.

Firmware upload process is described in detail at the "4.1.2 Firmware Upload"

☞ The initialization takes about 20~30 seconds after uploading the firmware.

㊲ Exit : It closes Configuration tool program.

4.1.2. Firmware Upload

- ① Execute Configuration Tool program and click 'Search' button.
- ② If the module is correctly connected to the network, its MAC address is displayed on the 'Board list'.

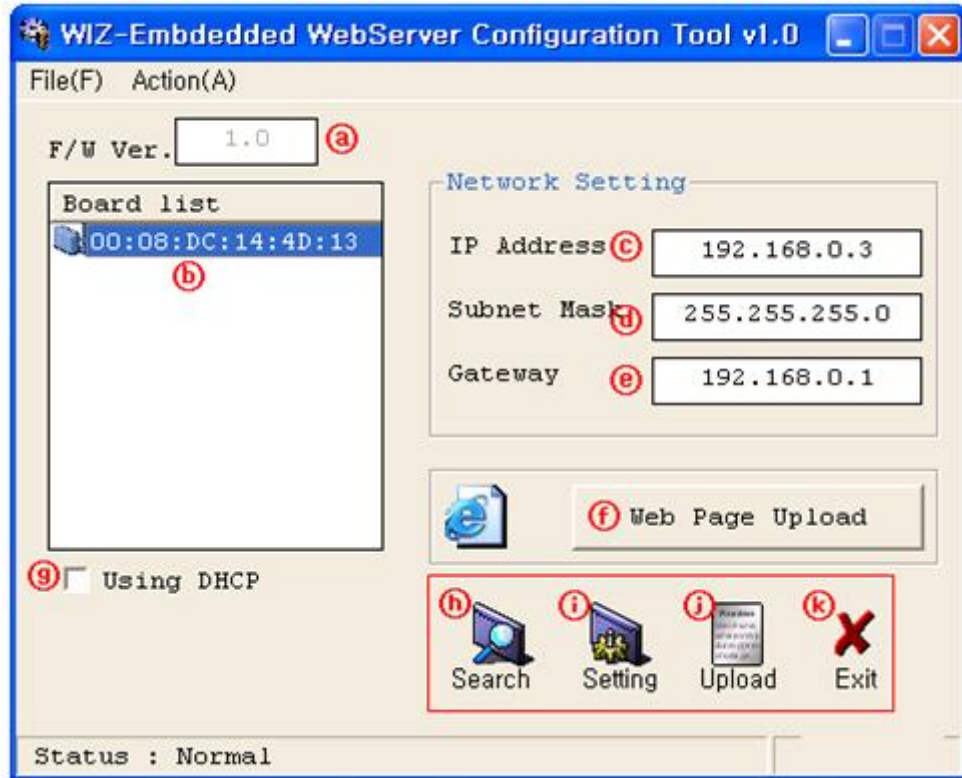

Figure 12. Board Search Window

- ③ Select a module at the 'Board list' and click 'Upload' button.

⚠ Before uploading through Ethernet, the network information should be set for correct network communication. By using PING test, it is possible to check if the value is appropriate for network communication.

- ④ As below dialog box is shown, select the Binary file and click 'OPEN' button.

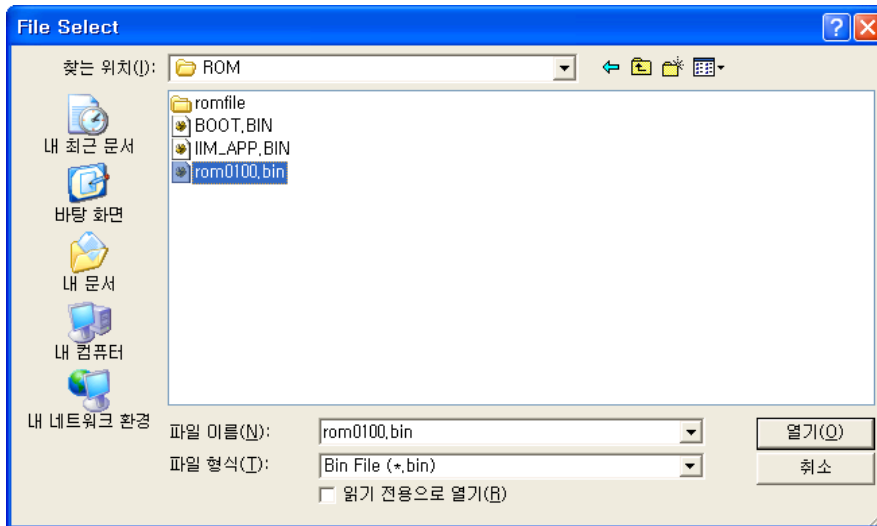

Figure 13. Open dialog box for uploading

☞ Be sure to use the firmware only for WIZ200WEB.

- ⑤ You can see below status window showing 'Processing'.

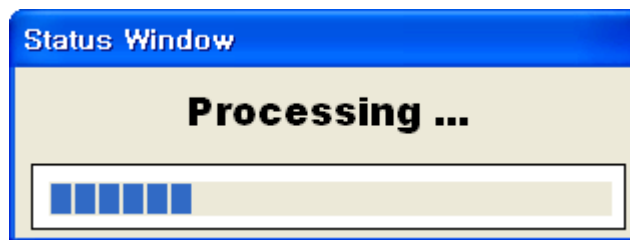

Figure 14. Firmware uploading window

- ⑥ If the file is uploaded, 'Complete Uploading' message is displayed.

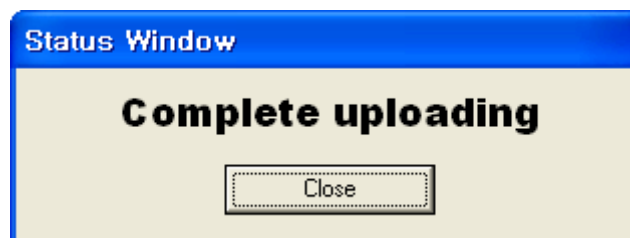

Figure 15. Complete Uploading

4.1.3. Webpage Upload

- ① Execute Configuration Tool program and click 'Search' button.
- ② If the module is correctly connected to the network, its MAC address is displayed on the

'Board list'.

- ③ Select the board at the 'Board list' and click 'web page Upload' button.

☞ Before uploading through Ethernet, the network information should be set for correct network communication. By using PING test, it is possible to check if the value is appropriate for network communication.

- ④ As below dialog box shows, select the Flash Rom File System (*.rom) file and click 'OPEN' button.

20

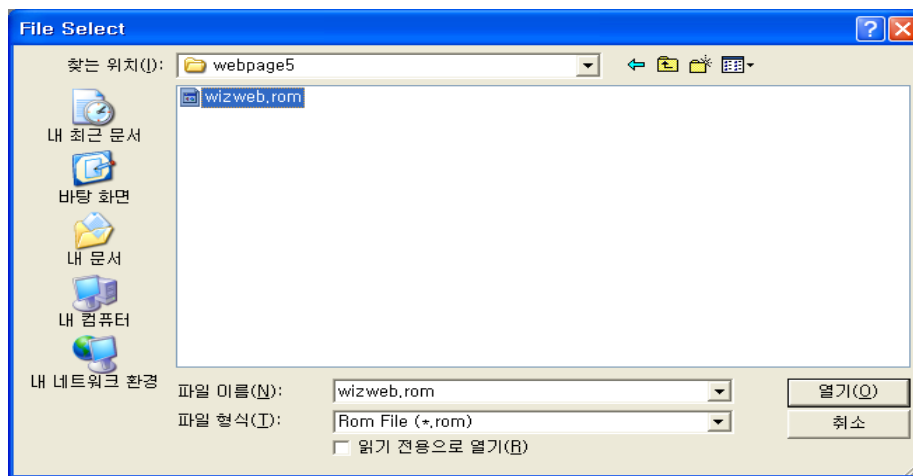

Figure 16. Flash Rom Image File

☞ The Flash Rom File System should be created by using "Rom File Maker Tool rev3.0". For the detail, refer to "4.1.4. Use of Rom File Maker rev3.0"

- ⑤ If the file is uploaded, 'Complete Uploading' message is displayed.

4.1.4. Use of Rom File Maker rev3.0

Rom File Maker rev3.0 is the tool for creating ROM Image which enables the webpage to be stored in the Flash memory.

Select the webpage by using 'Add Files' button.

☞ There is limitation of file number in selecting at a time. (Normally, max 15 files can be selected simultaneously). If there are more files, use "Add Files" button for the several times.

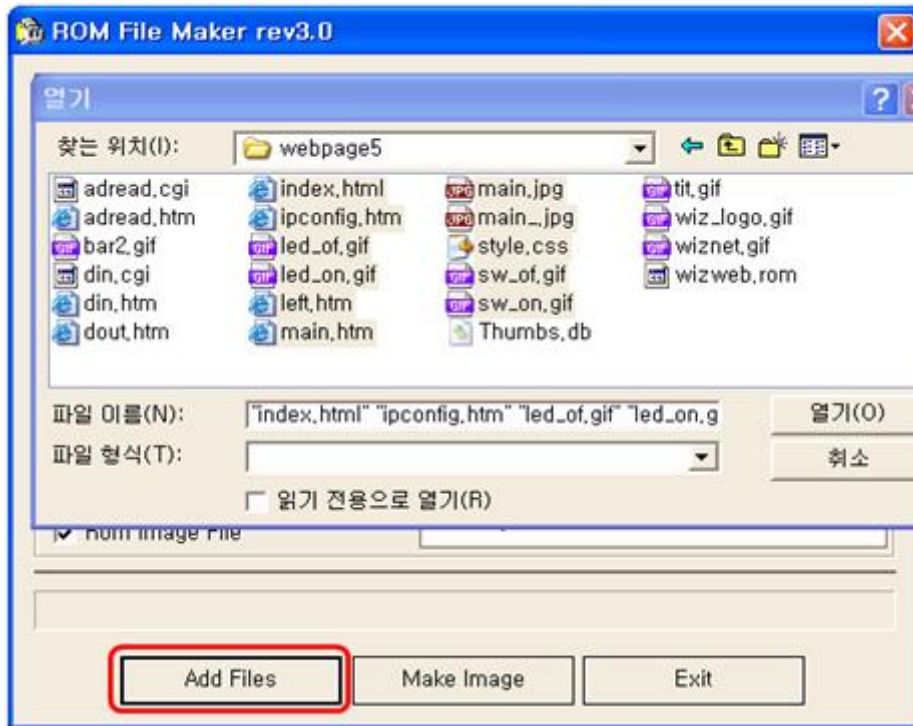

Figure 17. ROM File Maker

Select 'Rom Image File' option. If you click 'Make Image' button, '*.rom' file can be created.

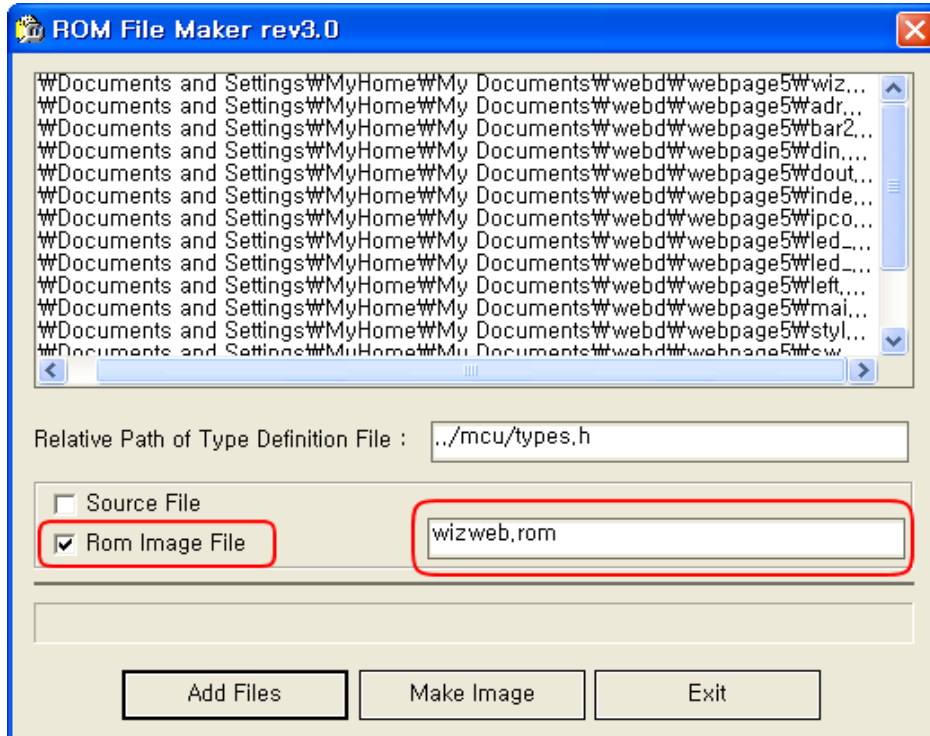

Figure 18. ROM Image File Make

4.2. Operation Test

In this chapter, we will show how WIZ200WEB operates through a sample testing. The hardware and software requirements for testing are as below.

	PC	WIZ200WEB
Hardware	1) LAN Port	1) WIZ200WEB Board 2) LAN Cable 3) DC5V Power Adaptor
Software	1) Configuration Tool Program 2) Web Browser	

Table 5. WIZ200WEB Testing Environment

4.2.1. Hardware Interface

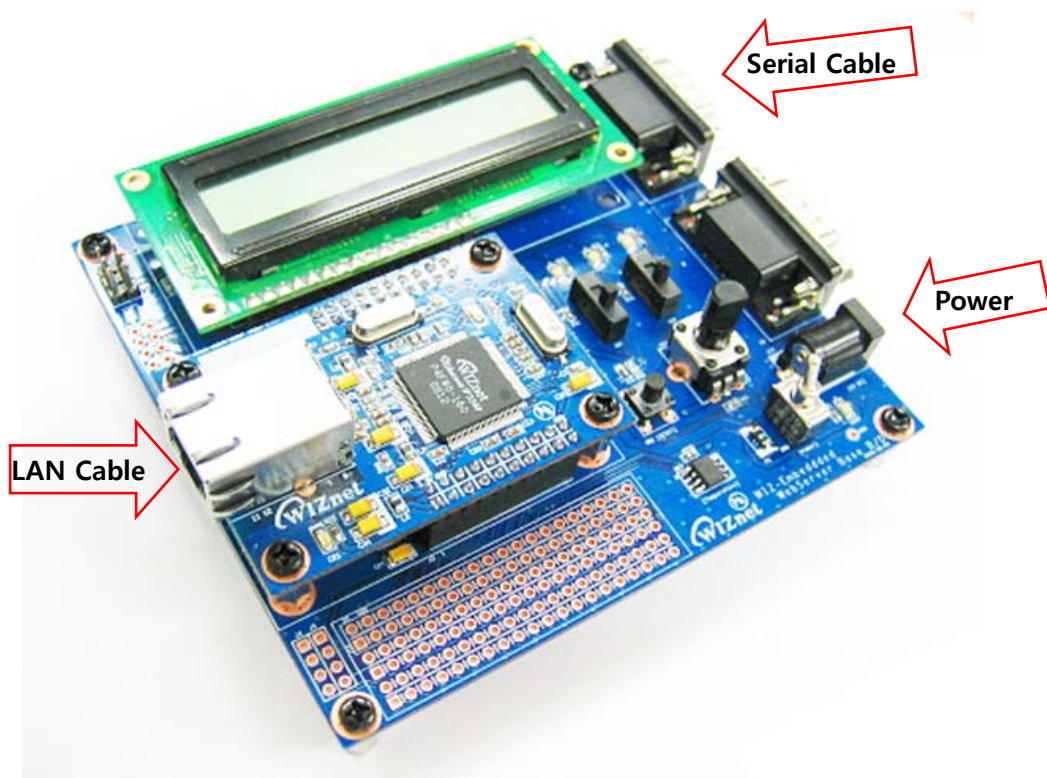

Figure 19. WIZ200WEB External Interface

Hardware installation process is as below.

STEP 1: By using RJ45 Ethernet cable, connect the board to the network.

STEP 2: Connect 5V DC adaptor to WIZ200WEB board.

4.2.2. Testing the Function of Web Server

STEP1: Supply the power to WIZ200WEB board.

STEP2: Configure the board by using Configuration Tool.

STEP3: Execute the web browser and input the IP address of the WIZ200WEB to access the webpage.

STEP4: If connection is appropriately processed, 'index.html' page is displayed on the web browser.



Figure 20. WIZ200WEB index page

STEP5: Click 'Digital Ouput' menu at the web browser, and control the LED and LCD installed on the WIZ200WEB Base Board.

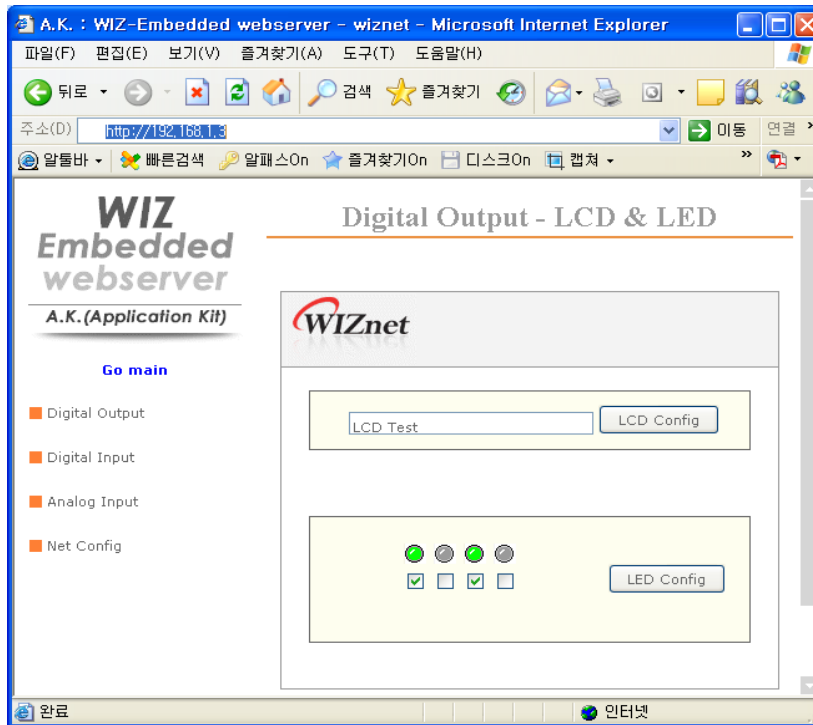

Figure 21. WIZ200WEB Digital Output Page

STEP6: Click 'Digital Input' menu, and check the status of switch installed on the WIZ200WEB Base Board. Switch status is updated every one second.

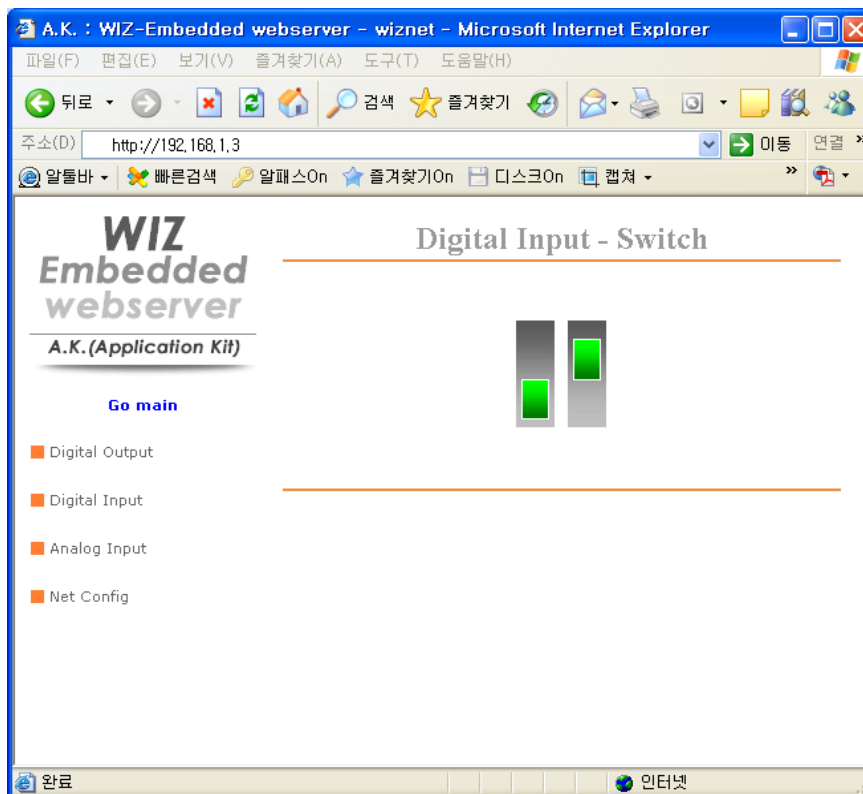

Figure 22. WIZ200WEB Digital Input Page

STEP7: Click 'Analog Input' menu and check the voltage level according to Variable Resistor(VR) which is installed on the WIZ200WEB Base Board. The VR is updated every second.

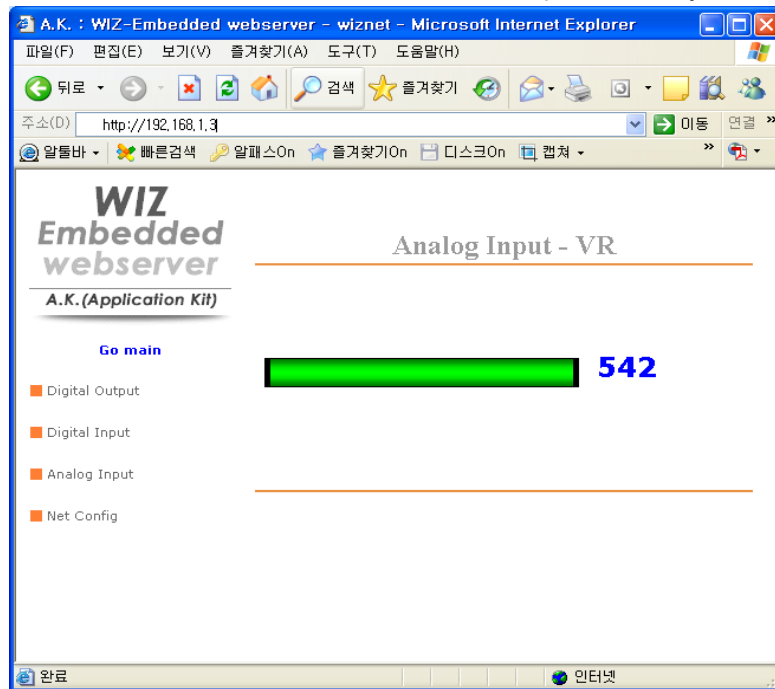
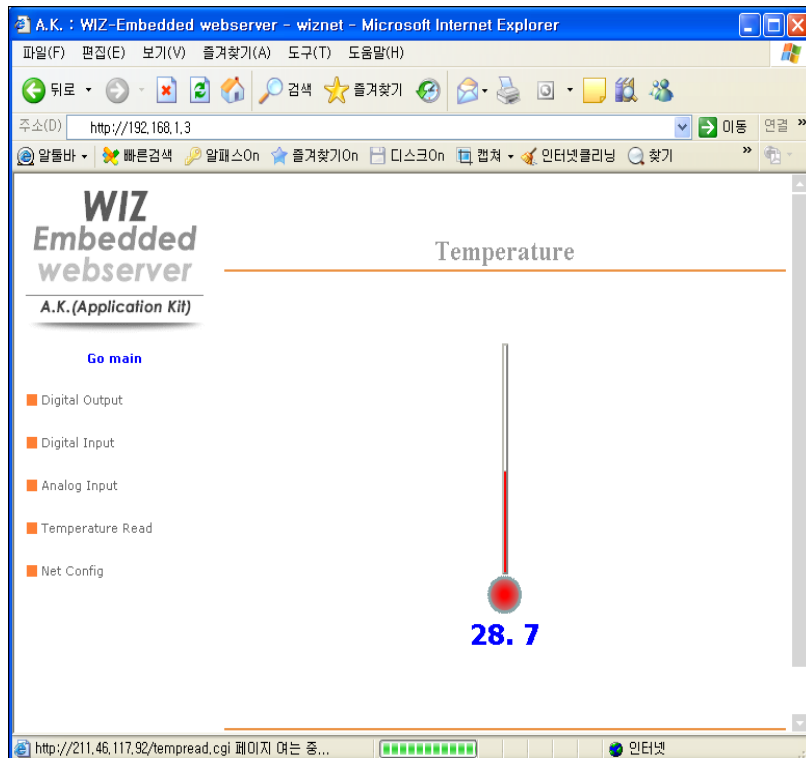

Figure 23. WIZ200WEB Analog Input Page

STEP8: Click "Temperature Read" menu and check current temperature by using the temperature sensor, TC77 installed on the WIZ200WEB Base Board.



5. Programmer's Guide

5.1. Memory Map

The memory map of WIZ200WEB is composed of 128Kbyte code memory and 64Kbyte data memory. The data memory is composed of internal SRAM and W5300. In addition, 4Kbyte EEPROM is built in AVR. Environment variables of the board are saved in this EEPROM.

Below figure shows the system memory map of the test board.

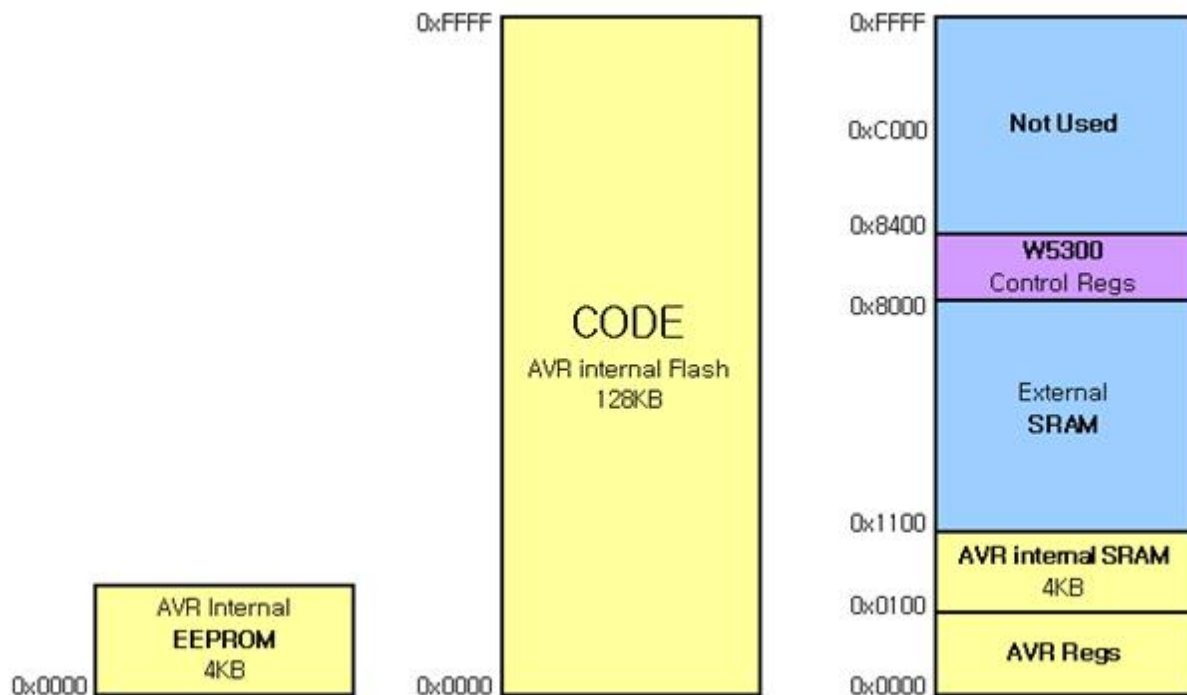

Figure 24. WIZ200WEB Memory Map

5.2. WIZ200WEB Firmware

The firmware performs ProcessWebServer, ProcessDhcp and ProcessConfig in the main() Function. ProcessWebServer() operates as webserver. It processes HTTP protocol from web browser, reads the web page in the Flash memory, and sends it. ProcessConfig() function processes network related configuration. ProcessDhcp() function does DHCP related functions.

ITEM(Folder name)	File	Function
main	main.c	WIZ200WEB F/W main()
	config_task.c	Net Configuration Task
	dhcp_task.c	DHCP Client Management

iinchip	iinchip_conf.h	System Dependant Definition of W5300
	w5300.c	w5300 I/O Function
	socket.c	w5300 Socket API
inet	dhcp.c	Processing DHCP Client Protocol
	httpd.c	Processing HTTP Protocol
mcu	delay.c	Processing the delay of ATmega128
	serial.c	UART related Function
	timer.c	Timer interrupt Process Function
	types.h	AVR Data Type & Global Definition
util	sockutil.c	Socket related Utility Function
	util.c	Utility Function
evb	config.c	Function to configure network related information
	dataflash.c	Function to process Serial Flash
	evb.c	Function to control devices on the board such as LED, Switch & LCD
	lcd.c	Function to process LCD
	spi.c	Function to process SPI
	romfile.c	Function to process ROM File System

Table 6. WIZ200WEB Main Source

5.3. Compile

The sources mentioned in the Chapter 5.2, are compiled by aligning in the SRC.

The firmware compile can be performed by using WINAVR and AVRSTUDIO.

Install the WINAVR and AVRSTUDIO in the PC. For the easy working, open the firmware project file "`~/main/ex03_webserver/wiz-web.apr`" through AVRSTUDIO project file.

Check compile setting of Configuration option of 'Project' menu. For the setting method, refer to 'AVR Studio User Guide'.

The firmware provided by WIZnet is based on AVR-GCC 3.4.6. In another version, the operation can be abnormal.

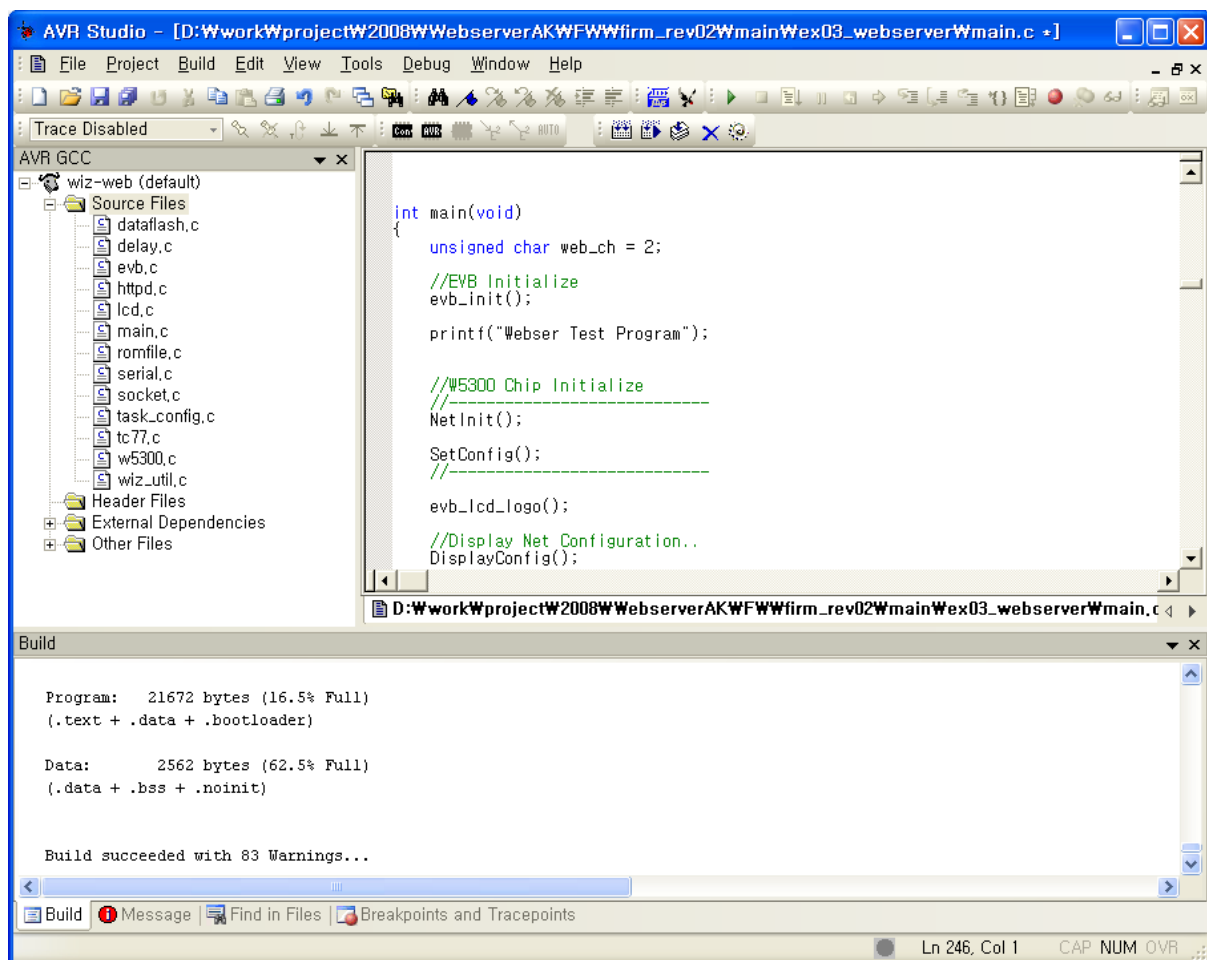

Figure 25. AVR Studio

When compile is completed, hex file is created in the folder that user defined before. This file is programmed to ATmega128.

5.4. Downloading

For the Hex file downloading, use AVR Studio and AVR ISP cable.

- 1) Connect the AVRISP cable to J9 of the Base Board.
- 2) Connect the power adaptor and turn on the switch.
- 3) Execute AVRStudio.exe
- 4) Select Atmega128 at the Device section
- 5) Select HEX file at the FLASH section
- 6) Click Program button.

For more detail, refer to 'AVR Tool Guide.pdf'.

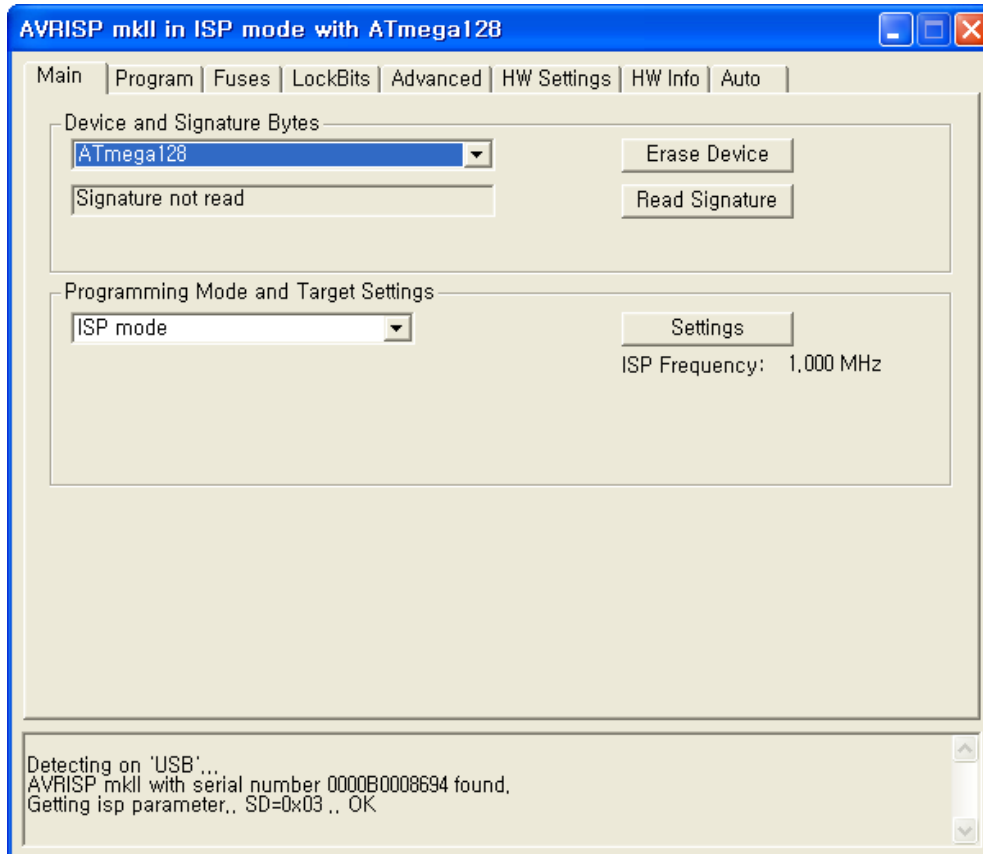

Figure 26. ATmega128 ISP

In order to update the firmware through network, the bootloader should be programmed first. Bootloader is written to be input at 0x1E000. For the re-programming the firmware file, remove the Atmega128 and program the 'Boot.hex' file. At this time, do not check the option of "Erase Device Before Programming" for not removing the bootloader.

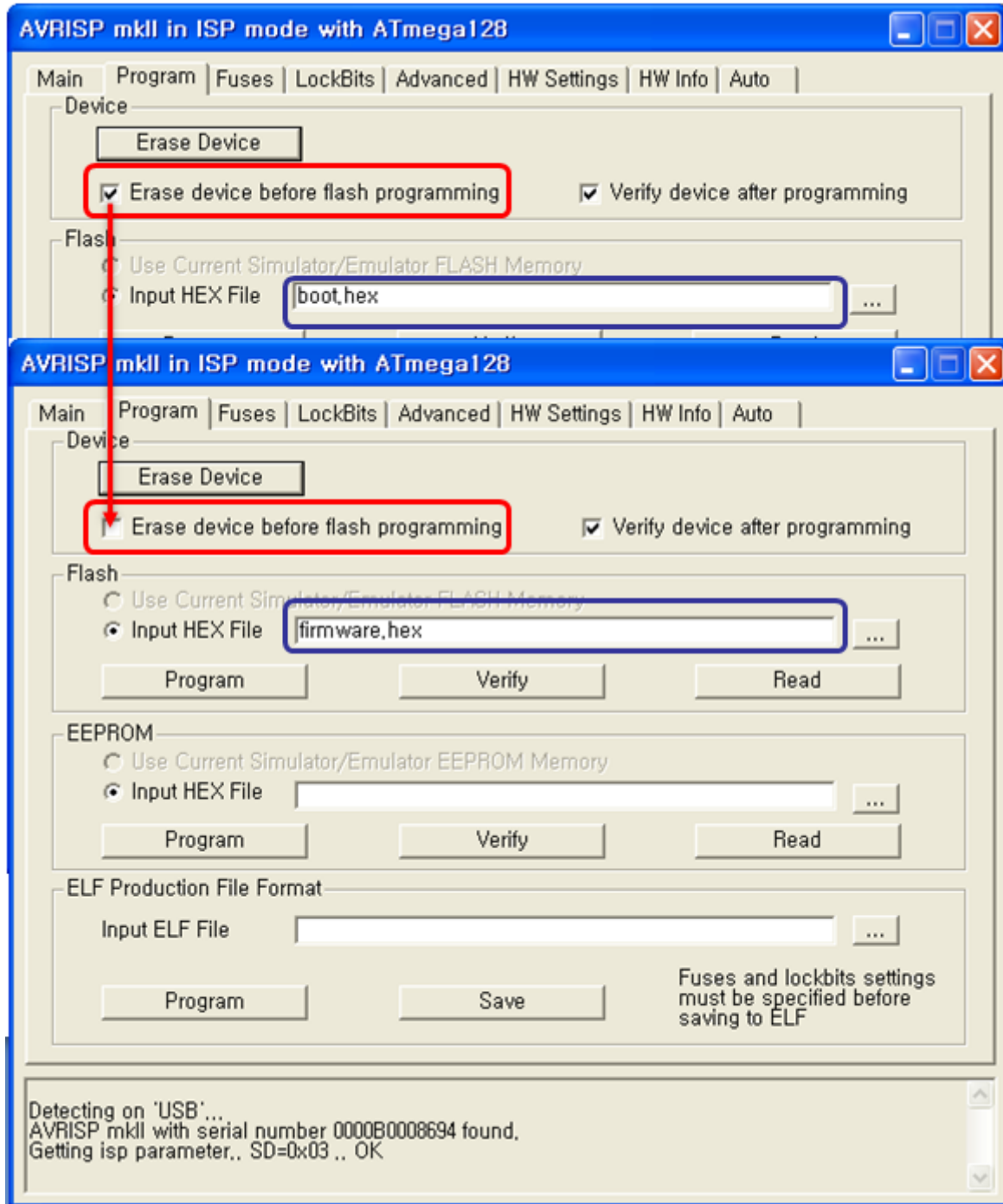

Figure 27. WIZ200WEB Boot Loader Program

6. WIZ200WEB Hardware Specification

6.1. Parameters

- Power 5V DC, 3.3V
- Dimension 60 x 42 x 14 (L x W x H)
- Temperature Operating : 0 ~ 80 °C
- Ethernet 10/100 Base-T Ethernet (Auto detection)

6.2. Specification

- MCU ATmega128
- FLASH 128KByte (MCU Internal) + 512Kbyte(External Serial Flash)
- SRAM 4KByte (MCU Internal) + 32Kbyte (External)
- EEPROM 4KByte (MCU Internal)

6.3. Board Dimensions and Pin Assignment

6.3.1. Pin Assignment

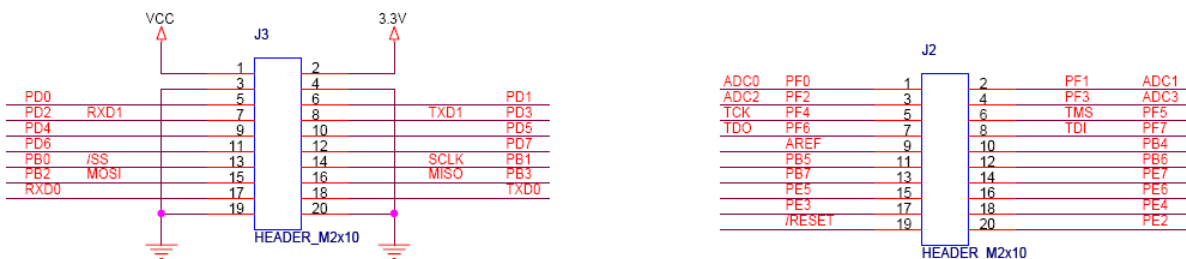

Figure 28. WIZ200WEB Pin Map

J3		J2	
3.3V	3.3V	ADC0/PF0	ADC1/PF1
GND	GND	ADC2/PF2	ADC3/PF3
SCL/INT0/PD0	SDA/INT0/PD1	ADC4/PF4	ADC5/PF5
RXD1/INT2/PD2	TXD1/INT3/PD3	ADC6/PF6	ADC7/PF7
ICP1/PD4	XCK1/PD5	AREF	PB4
T1/PD6	T2/PD7	PB5	PB6
SS/PB0	SCK/PB1	PB7	PE7
MOSI/PB2	MISO/PB3	PE5	PE6
RXD0/PE0	TXD0/PE1	PE3	PE4
GND	GND	/RESET	PE2

Table 7. WIZ200WEB PINMAP

6.3.2. Size

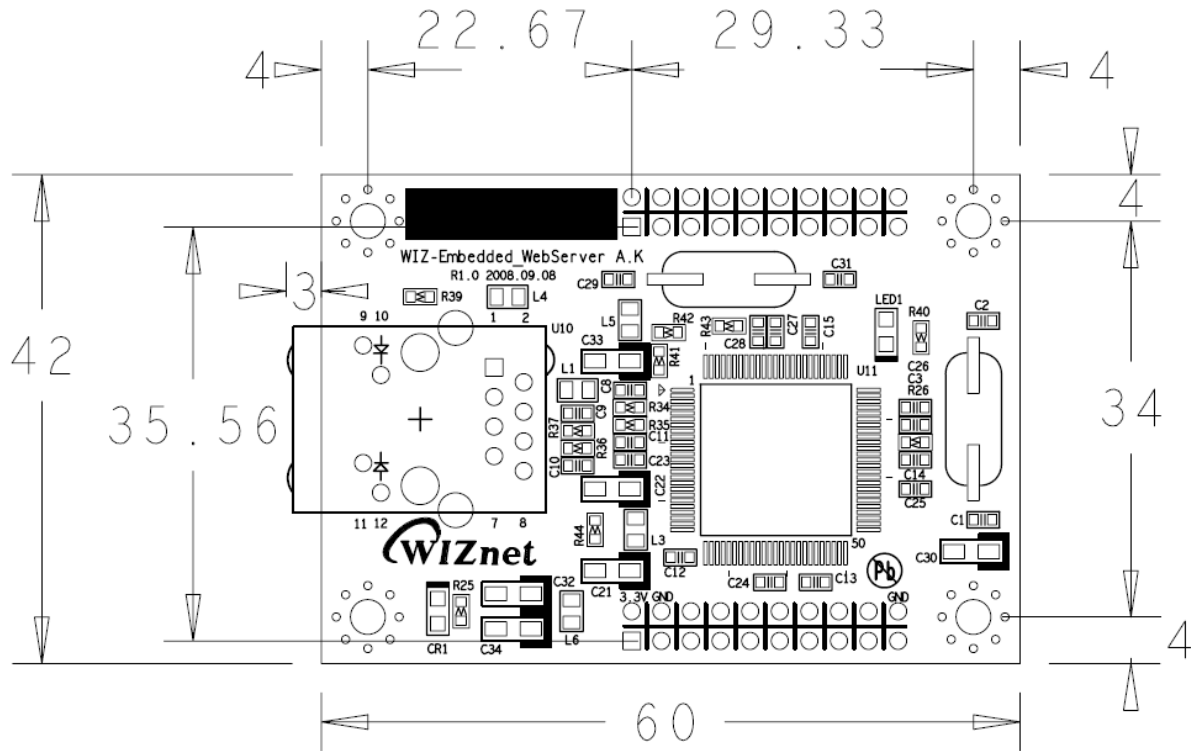

Figure 29. WIZ200WEB Module Dimension

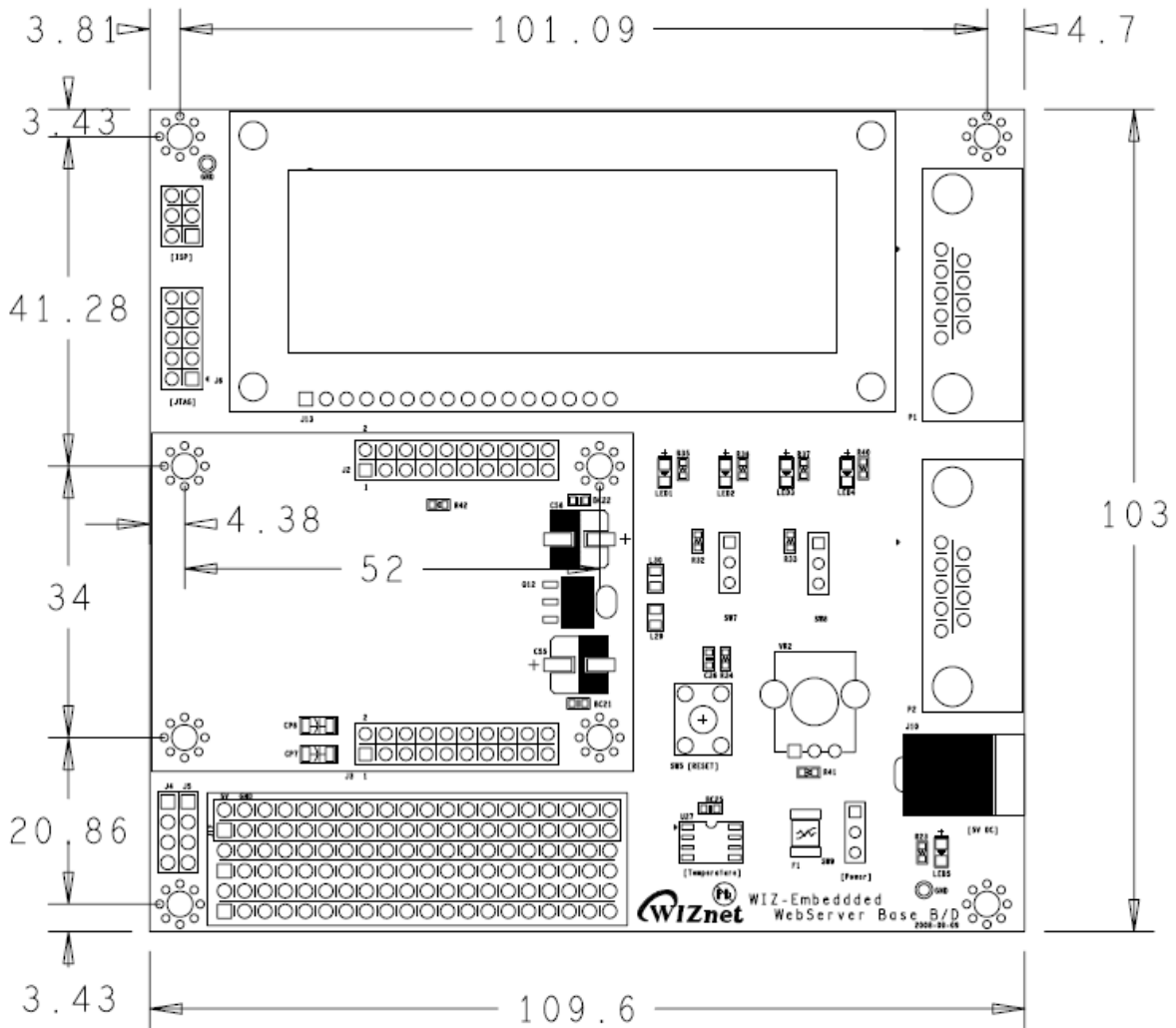

Figure 30. WIZ200WEB Base Board Size

6.3.3. Connector Specification

RJ45 : Ethernet Port Pinouts

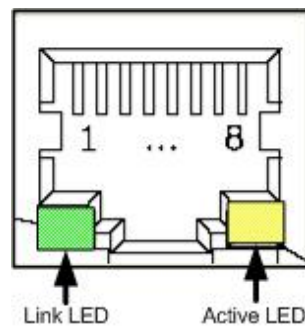
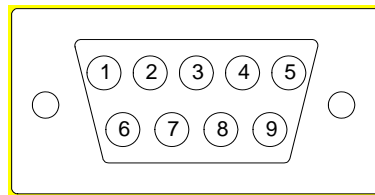

Figure 31. RJ-45 PIN Assignment

Pin	Signal
1	TX+
2	TX-
3	RX+
6	RX-

Figure 32. RJ-45 PIN Assignment

RS-232

Pin Number	Signal	Description
1	NC	Not Connected
2	RxD	Receive Data
3	TxD	Transmit Data
4	NC	Not Connected
5	GND	Ground
6	NC	Not Connected
7	NC	Not Connected
8	NC	Not Connected
9	NC	Not Connected

Figure 33. RS-232 PIN Assignment

7. Warranty

WIZnet Co., Ltd offers the following limited warranties applicable only to the original purchaser. This offer is non-transferable.

WIZnet warrants our products and its parts against defects in materials and workmanship under normal use for period of standard ONE(1) YEAR for the WIZ200WEB board and labor warranty after the date of original retail purchase. During this period, WIZnet will repair or replace a defective products or part free of charge.

35

Warranty Conditions:

The warranty applies only to products distributed by WIZnet or our official distributors.

1. The warranty applies only to defects in material or workmanship as mentioned above in 7. Warranty.
2. The warranty applies only to defects which occur during normal use and does not extend to damage to products or parts which results from alternation, repair, modification, faulty installation or service by anyone other than someone authorized by WIZnet Inc. ; damage to products or parts caused by accident, abuse, or misuse, poor maintenance, mishandling, misapplication, or used in violation of instructions furnished by us ; damage occurring in shipment or any damage caused by an act of God, such as lightening or line surge.

Procedure for Obtaining Warranty Service

1. Contact an authorized distributors or dealer of WIZnet Inc. for obtaining an RMA (Return Merchandise Authorization) request form within the applicable warranty period.
2. Send the products to the distributors or dealers together with the completed RMA request form. All products returned for warranty must be carefully repackaged in the original packing materials.
3. Any service issue, please contact to sales@wiznet.co.kr