

FEATURES

- Fast Response Time 180ns Max
- High Input Slew Rate 92V/ μ s
- Low Offset Voltage 0.3mV Typical, 0.8mV Max
- Low Offset Current 4nA Typical, 25nA Max
- Low Offset Drift 1 μ V/ $^{\circ}$ C, 30pA/ $^{\circ}$ C
- Standard Power Supplies +5V or \pm 5V to \pm 18V
- Guaranteed Operation from Single +5V Supply
- No Pull-Up Resistor Required for TTL Drive
- Wired OR Capability
- Fits 111, 106, 710 Sockets
- Easy Offset Nulling Single 2k Ω Potentiometer
- Easy to Use Free from Oscillations
- Available in Die Form

GENERAL DESCRIPTION

The CMP-01 is a monolithic fast precision voltage comparator using an advanced NPN-Schottky Barrier Diode process. It features fast response time to both large and small input signals, while maintaining excellent input characteristics. The CMP-01 is capable of operating over a wide range of supply voltages including single ended 5 volt supply. The large output current sinking and high output voltage capability assure good application flexibility, while the combination of fast response, high accuracy, and freedom from oscillation assure performance in precision level detectors and 12 and 13-bit A/D converters. The CMP-01 is pin-compatible to earlier 111, 106, and 710 types. For applications requiring lower input offset and bias currents, refer to the CMP-02 data sheet.

ORDERING INFORMATION †

T _A = +25°C V _{OS} MAX (mV)	PACKAGE			OPERATING TEMPERATURE RANGE
	TO-99	CERDIP 8-PIN	PLASTIC 8-PIN	
0.8	CMP01J*	CMP01Z/883	—	MIL
0.8	CMP01EJ	CMP01EZ	CMP01EP	COM
2.8	CMP01CJ	CMP01CZ	CMP01CP	COM

* For devices processed in total compliance to MIL-STD-883, add /883 after part number. Consult factory for 883 data sheet.
 † Burn-in is available on commercial and industrial temperature range parts in CerDIP, plastic DIP, and TO-can packages.

PIN CONNECTIONS

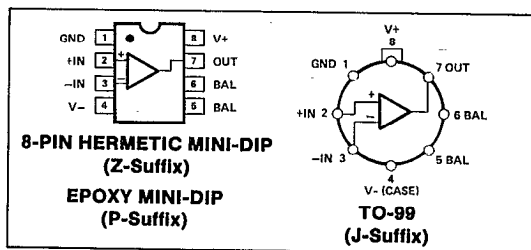

SIMPLIFIED SCHEMATIC

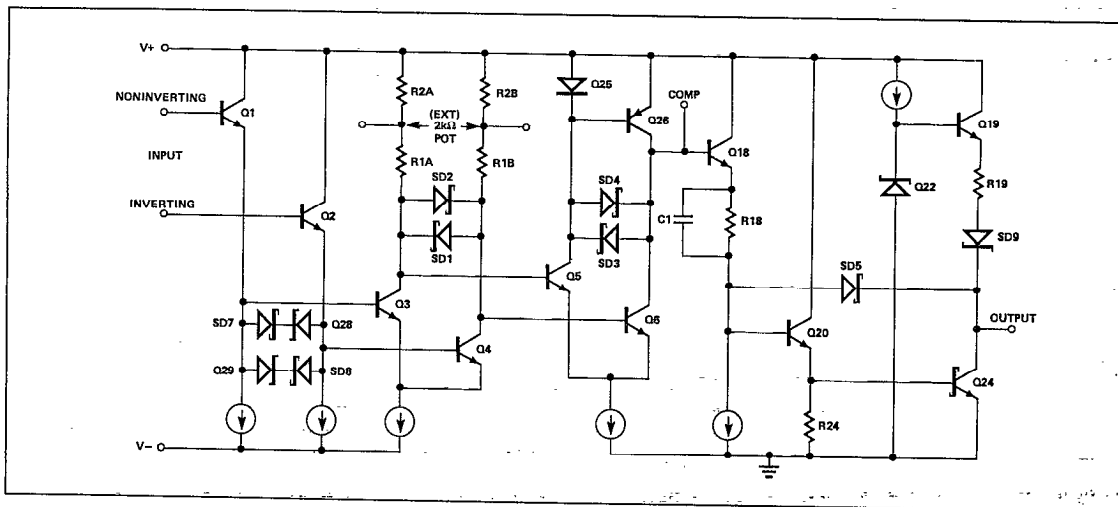

CMP-01

ABSOLUTE MAXIMUM RATINGS (Note 1)

Total Supply Voltage, V+ to V-	36V
Output to Ground	-5V to +32V
Output to Negative Supply Voltage	50V
Ground to Negative Supply Voltage	30V
Positive Supply Voltage to Ground	+30V
Positive Supply Voltage to Offset Null	0 to 2V
Differential Input Voltage	±11V
Input Voltage (V _S = ±15V)	±15V
Output Sink Current (Continuous Operation)	75mA
Operating Temperature Range	
CMP-01	-55°C to +125°C
CMP-01E, CMP-01C	0°C to +70°C
Junction Temperature (T _J)	-65°C to +150°C
Storage Temperature Range	-65°C to +150°C
P-Suffix	-65°C to +125°C

Lead Temperature (Soldering, 60 sec)	300°C
Output Short-Circuit Duration	
To Ground	Indefinite
To V+	1 Minute

PACKAGE TYPE	θ _{JA} (Note 2)	θ _{JC}	UNITS
TO-99 (J)	150	18	°C/W
8-Pin Plastic DIP (P)	148	16	°C/W
8-Pin SO (S)	103	43	°C/W

NOTES:

1. Absolute ratings apply to both DICE and packaged parts, unless otherwise noted.
2. θ_{JA} is specified for worst case mounting conditions, i.e., θ_{JA} is specified for device in socket for TO and P-DIP packages.

ELECTRICAL CHARACTERISTICS at V_S = ±15V, T_A = 25°C, unless otherwise noted.

PARAMETER	SYMBOL	CONDITIONS	CMP-01 CMP-01E			CMP-01C			UNITS
			MIN	TYP	MAX	MIN	TYP	MAX	
Input Offset Voltage	V _{OS}	R _G ≤ 5kΩ, (Note 1)	—	0.3	0.8	—	0.4	2.8	mV
Input Offset Current	I _{OS}	(Note 1)	—	4	25	—	5	80	nA
Input Bias Current	I _B		—	350	600	—	400	900	nA
Differential Input Resistance	R _{IN}	(Note 2)	150	300	—	100	200	—	kΩ
Voltage Gain	A _V	V _O = 0.4V to 2.4V, (Notes 1, 2)	200	500	—	100	500	—	V/mV
Response Time (Note 3)	t _r	100mV step, 5mV Overdrive No Load (No Pull-Up)	—	110	180	—	110	180	ns
		5kΩ to 5v (Pull-Up)	—	110	—	—	110	—	
		TTL Fan-Out = 4, No Pull-Up	—	110	—	—	110	—	
		5V Step 5mV Overdrive No Load (No Pull-Up)	—	160	—	—	160	—	
		5kΩ to 5v (Pull-Up)	—	160	—	—	160	—	
TTL Fan-Out = 4, No Pull-Up	—	160	—	—	160	—			
Input Slew Rate			—	92	—	—	92	—	V/μs
Input Voltage Range	CMVR		±12.5	±13	—	±12.5	±13	—	V
Common-Mode Rejection Ratio	CMRR		94	110	—	90	110	—	dB
Power Supply Rejection Ratio	PSRR	5V ≤ V _{S+} ≤ 18V, -18V ≤ V _{S-} ≤ 0V	80	100	—	74	98	—	dB
Positive Output Voltage	V _{OH}	V _{IN} ≥ 3mV, I _O = 320μA	2.4	3.2	—	—	—	—	V
		V _{IN} ≥ 3mV, I _O = 240μA	—	—	—	2.4	3.4	—	
		V _{IN} ≥ 3mV, I _O = 0mA	2.4	4.8	—	2.4	4.8	—	
Saturation Voltage	V _{OL}	V _{IN} ≤ -10mV, I _{sink} = 0mA	—	0.16	0.4	—	0.16	0.4	V
		V _{IN} ≤ -10mV, I _{sink} ≤ 6.4mA	—	0.3	0.45	—	0.31	0.45	
		V _{IN} ≤ -10mV, I _{sink} ≤ 12mA (CMP-01 only)	—	0.36	0.5	—	—	—	
Output Leakage Current	I _{LEAK}	V _{IN} ≥ 10mV, V _O = +30V	—	0.03	2	—	0.05	8	μA
Positive Supply Current	I ₊	V _{IN} ≤ -10mV	—	5.6	8	—	5.6	8.5	mA
Negative Supply Current	I ₋	V _{IN} ≤ -10mV	—	1.3	2.2	—	1.3	2.2	mA
Power Dissipation	P _d	V _{IN} ≤ -10mV	—	103	153	—	103	161	mW
Offset Voltage Adjustment Range		Nulling Pot ≥ 2kΩ	—	±5	—	—	±5	—	mV

NOTES:

1. These parameters are specified as the maximum values required to drive the output between the logic levels of 0.4V and 2.4V with a 1kΩ load tied to +5V; thus, these parameters define an error band which takes into

- account the worst case effects of voltage gain and input impedance.
2. Guaranteed by design.
3. Sample tested.

ELECTRICAL CHARACTERISTICS at $V_{S+} = 5V$, $V_{S-} = 0V$, $T_A = 25^\circ C$, unless otherwise noted.

PARAMETER	SYMBOL	CONDITIONS	CMP-01 CMP-01E			CMP-01C			UNITS
			MIN	TYP	MAX	MIN	TYP	MAX	
Input Offset Voltage	V_{OS}	$R_S \leq 5k\Omega$, (Note 1)	—	0.4	1.5	—	0.5	3.5	mV
Input Offset Current	I_{OS}	(Note 1)	—	3	21	—	4	65	nA
Input Bias Current	I_B		—	250	500	—	300	720	nA
Voltage Gain	A_V	$V_O = 0.4V$ to $2.4V$, (Notes 1, 2)	—	50	—	—	50	—	V/mV
Response Time	t_r	100mV Step, 5mV Overdrive	—	150	—	—	150	—	ns
		5k Ω to 5V (Pull-Up) TTL Fan-Out = 4, 5k Ω to 5V (Pull-Up)	—	150	—	—	150	—	
Input Voltage Range	CMVR		1.8	1.7-3.8	3.5	1.8	1.7-3.8	3.5	V
Saturation Voltage	V_{OL}	$V_{IN} \leq -10mV$, $I_{sink} \leq 6.4mA$	—	0.3	0.45	—	0.3	0.45	V
Positive Supply Current	I_+	$V_{IN} \leq -10mV$	—	2.3	3.2	—	2.4	3.8	mA
Power Dissipation	P_d	$V_{IN} \leq -10mV$	—	11.5	16	—	12	19	mW

3

ELECTRICAL CHARACTERISTICS at $V_S = \pm 15V$, $-55^\circ C \leq T_A \leq 125^\circ C$, unless otherwise noted.

PARAMETER	SYMBOL	CONDITIONS	CMP-01			UNITS
			MIN	TYP	MAX	
Input Offset Voltage	V_{OS}	$R_S \leq 5k\Omega$, (Note 1) $V_{S+} = 5V$, $V_{S-} = 0V$, (Note 1)	—	0.5	1.6	mV
Average Input Offset Voltage Drift			—	0.6	2.8	
Without External Trim	TCV_{OS}	$R_S = 50\Omega$	—	1.5	—	$\mu V/^\circ C$
With External Trim	TCV_{OSn}		—	1	—	
Input Offset Current	I_{OS}	$T_A = +125^\circ C$, (Note 1) $T_A = -55^\circ C$, (Note 1)	—	4	25	nA
Average Input Offset Current Drift	TCI_{OS}	$+25^\circ C \leq T_A \leq +125^\circ C$ $-55^\circ C \leq T_A \leq +25^\circ C$	—	5	45	
Input Bias Current	I_B	$T_A = +125^\circ C$ $T_A = -55^\circ C$	—	12	—	$pA/^\circ C$
Voltage Gain	A_V	$V_O = 0.4V$ to $2.4V$, (Notes 1, 2)	—	35	—	
Response Time	t_r	100mV Step, 5mV Overdrive, (Note 2) $T_A = +125^\circ C$, No Load $T_A = -55^\circ C$, No Load	—	330	600	ns
Input Voltage Range	CMVR		—	550	1400	
Common-Mode Rejection Ratio	CMRR		± 12	± 13	—	V
Power Supply Rejection Ratio	PSRR	$5V \leq V_{S+} \leq 15V$, $-15V \leq V_{S-} \leq 0V$	88	106	—	dB
Positive Output Voltage	V_{OH}	$V_{IN} \geq 4mV$, $I_O = 200\mu A$	75	96	—	dB
Saturation Voltage	V_{OL}	$V_{IN} \leq -10mV$, $I_{sink} = 0mA$ $V_{IN} \leq -10mV$, $I_{sink} = 6.4mA$	2.4	3	—	V
			—	0.20	0.4	V
			—	0.32	0.5	V

NOTES:

1. These parameters are specified as the maximum values required to drive the output between the logic levels of 0.4V and 2.4V with a 1k Ω load tied to +5V; thus, these parameters define an error band which takes into account the worst case effects of voltage gain and input impedance.
2. Guaranteed by design.

CMP-01

ELECTRICAL CHARACTERISTICS at $V_S = \pm 15V$, $0^\circ C \leq T_A \leq 70^\circ C$, unless otherwise noted.

PARAMETER	SYMBOL	CONDITIONS	CMP-01E			CMP-01C			UNITS
			MIN	TYP	MAX	MIN	TYP	MAX	
Input Offset Voltage	V_{OS}	$R_B \leq 5k\Omega$, (Note 1) $V_{S+} = 5V, V_{S-} = 0V$, (Note 1)	—	0.4	1.4	—	0.5	3.5	mV
Average Input Offset Voltage Drift									
Without External Trim	TCV_{OS}	$R_B = 50\Omega$	—	1.5	—	—	1.8	—	$\mu V/^\circ C$
With External Trim	TCV_{OSn}		—	1.0	—	—	1.2	—	
Input Offset Current	I_{OS}	$T_A = +70^\circ C$, (Note 1) $T_A = 0^\circ C$, (Note 1)	—	4	25	—	5	80	nA
Average Input Offset Current Drift	TCI_{OS}	$+25^\circ C \leq T_A \leq +70^\circ C$ $0^\circ C \leq T_A \leq +25^\circ C$	—	12	—	—	12	—	$pA/^\circ C$
Input Bias Current	I_B	$T_A = +70^\circ C$ $T_A = 0^\circ C$	—	330	600	—	340	900	nA
Voltage Gain	A_V	$V_O = 0.4V$ to $2.4V$, (Notes 1, 2)	100	500	—	70	500	—	V/mV
Response Time	t_r	100mV Step, 5mV Overdrive $T_A = +70^\circ C$, No Load $T_A = 0^\circ C$, No Load	—	150	—	—	150	—	ns
Input Voltage Range	CMVR		± 12.0	± 13.3	—	± 12.0	± 13.3	—	V
Common-Mode Rejection Ratio	CMRR		90	108	—	86	108	—	dB
Power Supply Rejection Ratio	PSRR	$5V \leq V_{S+} \leq 15V, -15V \leq V_{S-} \leq 0V$	77	98	—	70	88	—	dB
Positive Output Voltage	V_{OH}	$V_{IN} \geq 4mV, I_O = 200\mu A$	2.4	3.2	—	2.4	3.2	—	V
Saturation Voltage	V_{OL}	$V_{IN} \leq -10mV, I_{sink} = 0$ $V_{IN} \leq -10mV, I_{sink} = 6.4mA$	—	0.17	0.4	—	0.17	0.4	V

NOTES:

1. These parameters are specified as the maximum values required to drive the output between the logic levels of 0.4V and 2.4V with a 1k Ω load tied to +5V; thus, these parameters define an error band which takes into account the worst case effects of voltage gain and input impedance.
2. Guaranteed by design.

DICE CHARACTERISTICS

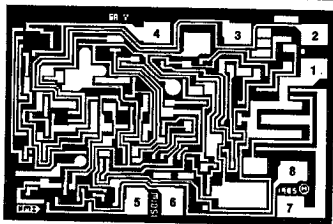

- 1. GROUND
- 2. NONINVERTING INPUT
- 3. INVERTING INPUT
- 4. NEGATIVE SUPPLY (SUBSTRATE)
- 5. BALANCE
- 6. BALANCE
- 7. OUTPUT
- 8. POSITIVE SUPPLY

DIE SIZE 0.065 × 0.043 inch, 2730 sq. mils
(1.651 × 1.092 mm, 1.803 sq. mm)

WAFER TEST LIMITS at $V_S = \pm 15V$, $T_A = 25^\circ C$.

3

PARAMETER	SYMBOL	CONDITIONS	CMP-01N LIMIT	CMP-01GR LIMIT	UNITS
Input Offset Voltage	V_{OS}	$R_S \leq 5k\Omega$, (Note 1)	0.8	2.8	mV MAX
Input Offset Current	I_{OS}	(Note 1)	25	80	nA MAX
Input Bias Current	I_B		600	900	nA MAX
Differential Input Resistance	R_{IN}	(Note 2)	150	100	k Ω MIN
Input Voltage Range	CMVR		± 12.5	± 12.5	V MIN
Common-Mode Rejection Ratio	CMRR	$V_{CM} = \pm CMVR$	94	90	dB MIN
Power Supply Rejection Ratio	PSRR	$5V \leq V_S + \leq 18V$ $-18V \leq V_S - \leq 0V$	80	74	dB MIN
Positive Output Voltage	V_{OH}	$V_{IN} \geq 3mV$, $I_O = 320\mu A$ $V_{IN} \geq 3mV$, $I_O = 240\mu A$	2.4	—	V MIN
Saturation Voltage	V_{OL}	$I_{sink} = 6.4mA$	0.45	0.45	V MAX
Output Leakage Current	I_{LEAK}	$V_{IN} \geq 10mV$, $V_O = 30V$	2	8	μA MAX
Positive Supply Current	I+	$V_{IN} \leq -10mV$	8.0	8.5	mA MAX
Negative Supply Current	I-	$V_{IN} \leq -10mV$	2.2	2.2	mA MAX
Power Consumption	P_d	$V_{IN} \leq -10mV$	153	161	mW MAX

NOTES:

- 1. These parameters are specified as the maximum values required to drive the output between the logic levels of 0.4V and 2.4V with a 1k Ω load tied to +5V; thus, these parameters define an error band which takes into account the worst case effects of voltage gain and input impedance.
- 2. Guaranteed by design.

WAFER TEST LIMITS at $V_{S+} = 5V$ and $V_{S-} = 0V$, $T_A = 25^\circ C$.

PARAMETER	SYMBOL	CONDITIONS	CMP-01N LIMIT	CMP-01GR LIMIT	UNITS
Input Offset Voltage	V_{OS}	$R_S \leq 5k\Omega$, (Note 1)	1.5	3.5	mV MAX
Input Offset Current	I_{OS}		21	65	nA MAX

NOTE:

Electrical tests are performed at wafer probe to the limits shown. Due to variations in assembly methods and normal yield loss, yield after packaging is not guaranteed for standard product dice. Consult factory to negotiate specifications based on dice lot qualification through sample lot assembly and testing.

TYPICAL ELECTRICAL CHARACTERISTICS at $V_S = \pm 15V$, and $25^\circ C$.

PARAMETER	SYMBOL	CONDITIONS	CMP-01N TYPICAL	CMP-01GR TYPICAL	UNITS
Average Input Offset Voltage Drift	TCV_{OS}	$R_S = 50\Omega$	1.5	1.8	$\mu V/^\circ C$
Average Input Offset Current Drift	TCI_{OS}		35	40	pA/°C
Response Time	t_r	100mV Step, 5mV Overdrive No Load (No Pull-Up), $T_A = 25^\circ C$	110	110	ns

CMP-01

TYPICAL PERFORMANCE CHARACTERISTICS

**RESPONSE TIME,
100mV STEP, 5mV OVERDRIVE, VARIOUS LOADS**

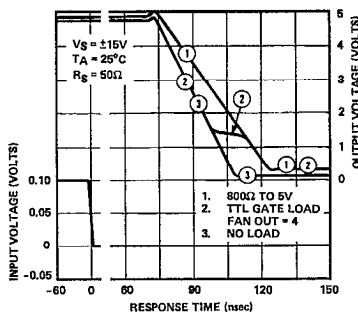
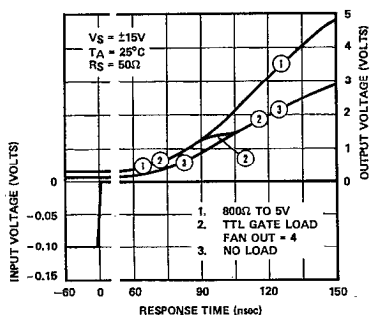

RESPONSE TIME TEST CIRCUIT

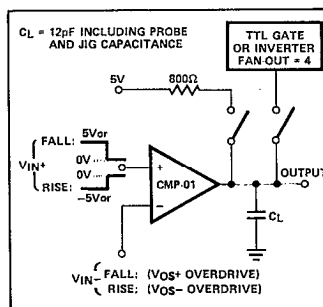

**INPUT OFFSET ERROR vs
SOURCE RESISTANCE**

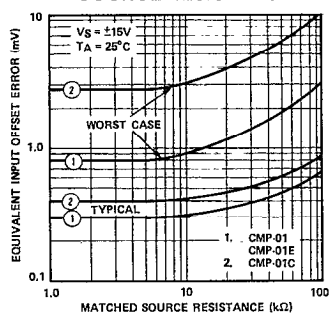

**OFFSET VOLTAGE vs
TEMPERATURE**

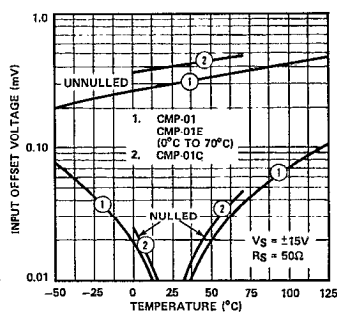

**INPUT OFFSET CURRENT
vs TEMPERATURE**

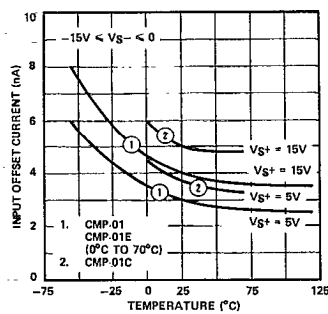

**INPUT BIAS CURRENT
vs TEMPERATURE**

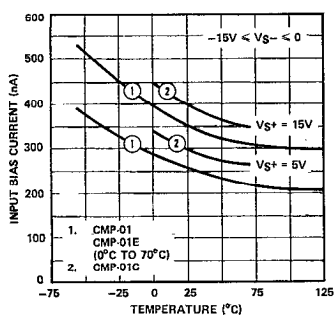

**INPUT BIAS CURRENT
vs DIFFERENTIAL
INPUT VOLTAGE**

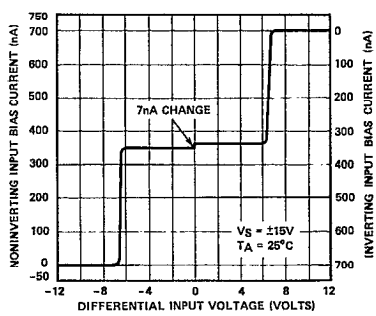

**INPUT VOLTAGE RANGE
vs TEMPERATURE**

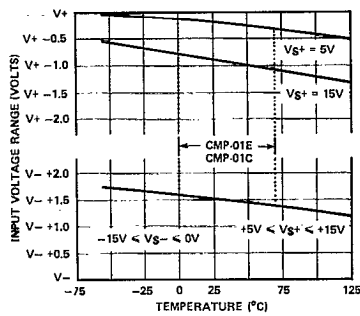

TYPICAL PERFORMANCE CHARACTERISTICS

RESPONSE TIME FOR 100mV STEP AND VARIOUS INPUT OVERDRIVES

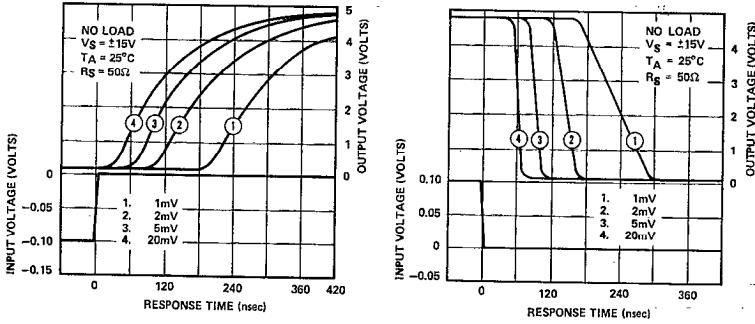

RESPONSE TIME vs SOURCE RESISTANCE

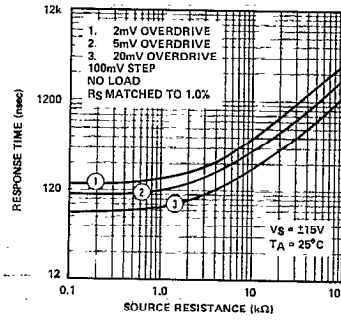

3

SATURATION VOLTAGE vs SINK CURRENT

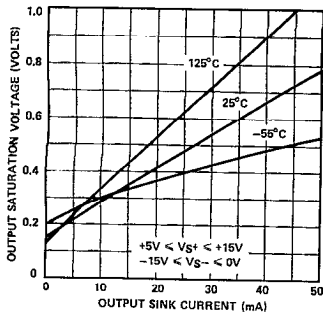

SUPPLY CURRENT vs SUPPLY VOLTAGE

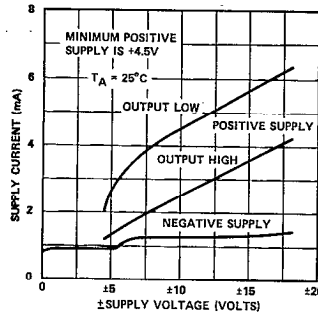

POWER CONSUMPTION vs TEMPERATURE

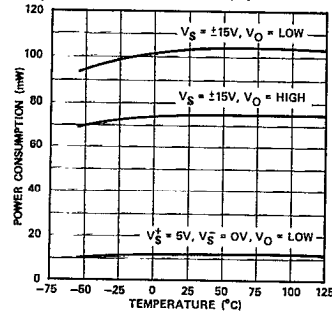

OFFSET TRIMMING AND STROBE CIRCUIT

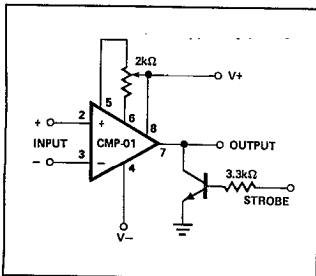

RESPONSE TIME FOR 5V STEP AND 5mV OVERDRIVE

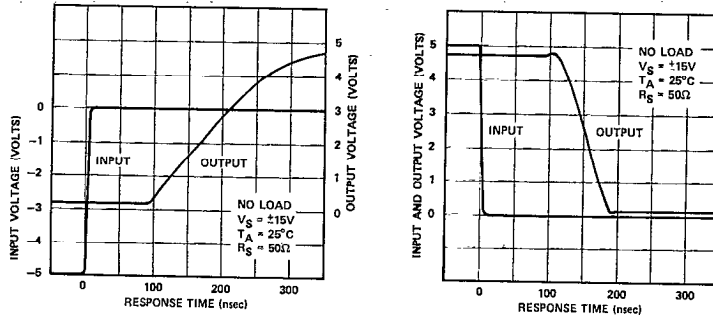

CMP-01

APPLICATIONS INFORMATION

The CMP-01 provides fast response times even with small overdrives; to achieve this performance requires very high gain at high frequencies. The CMP-01 is completely free of oscillations; however, small values of stray capacitance from output to input when combined with high-source resistances can cause an unstable condition. DC characteristics are not affected, but when the input is within a few microvolts of the transition level, certain conditions can create an oscillation region. The width of this oscillatory region and the size of source resistance where oscillations begin is a strong function of the stray coupling present. The following suggestions are offered as a guide towards minimizing the conditions for oscillation: matched source resistors, minimized stray capacitances (e.g., a ground plane between output and input), or capacitive output loading (C_L). The capacitive loading techniques will eliminate the oscillations, but result in slower response time. Matched bypass capacitors across the input resistors also can eliminate the instability,

$$\text{and if } C_S \geq 20\text{pF} \left(\begin{array}{l} \text{maximum step size} \\ \text{minimum overdrive} \end{array} \right)$$

the response time will approximate the response time for low values of R_S . It should be noted that the offset nulling terminals do not require bypassing for stability. As with all

wideband circuits, it is recommended that the supplies be bypassed near the socket of the device.

MINIMIZING OSCILLATION

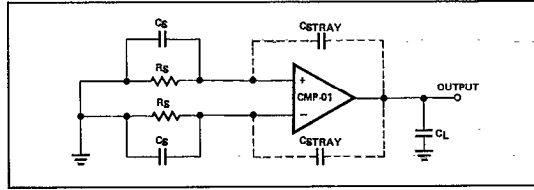

BURN-IN CIRCUIT

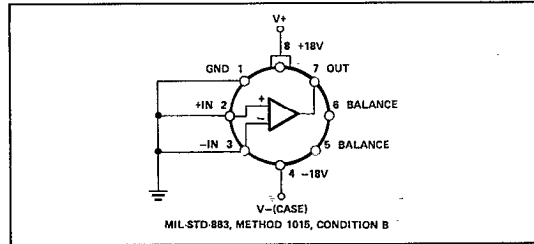

8-BIT TRACKING A/D CONVERTER

