

## TUNING FORK CRYSTAL UNIT (SMD · Cylinder Type)

RoHS compliant / Pb free

# CMR200T

2,000pcs/reel



### FEATURES

- Reflowable cylinder type
- Frequency range : 32.768kHz
- External dimensions (mm)  
Φ : 2.0 x L : 6.1
- Applications  
Smart Meters / Consumer products

### DIMENSION [mm]

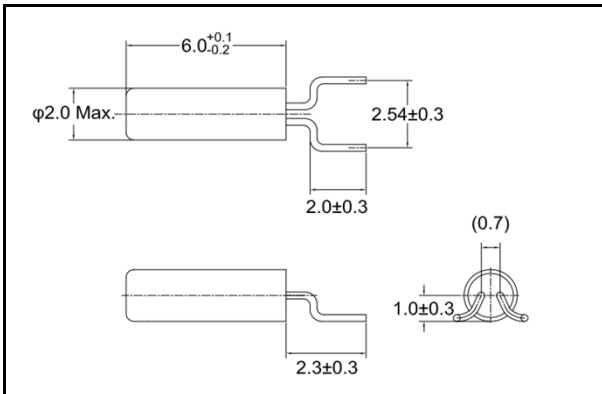

### SOLDER PAD LAYOUT [mm]

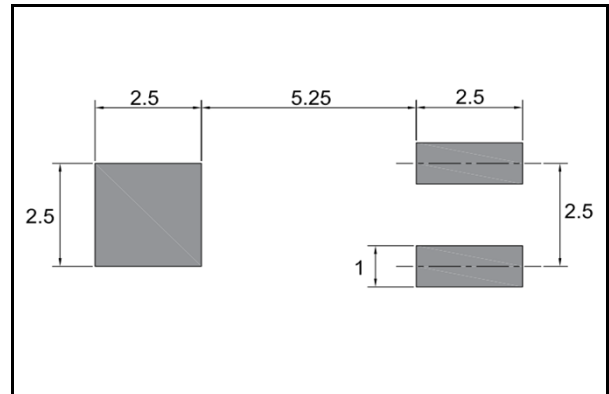

### STANDARD SPECIFICATIONS

Item	Model	CMR200T	Conditions
Nominal Frequency	$f_0$	32.768kHz	
Frequency Tolerance	$\Delta f/f_0$	$\pm 10\text{ppm} / \pm 20\text{ppm}$	at 25°C
Load capacitance	$C_L$	6.0pF / 7.0pF / 12.5pF	Please specify your requirement
Operating Temperature Range	$T_{OPR}$	-40°C ~ +85°C	
Storage Temperature Range	$T_{STR}$	-55°C ~ +125°C	
Turnover Temperature	$T_M$	25°C±5°C	
Temperature Coefficient	$\beta$	-0.034±0.006ppm/°C <sup>2</sup>	
Motional (series) resistance	$R_1$	50K Ω Max.	at 25°C
Level of drive	$D_L$	1 μW Max.	
Aging (first year)	$\Delta f/f_0$	±3ppm Max.	25°C±3°C
Shunt capacitance	$C_0$	1.35pF Typ.	

## ■ PART NUMBERING SYSTEM

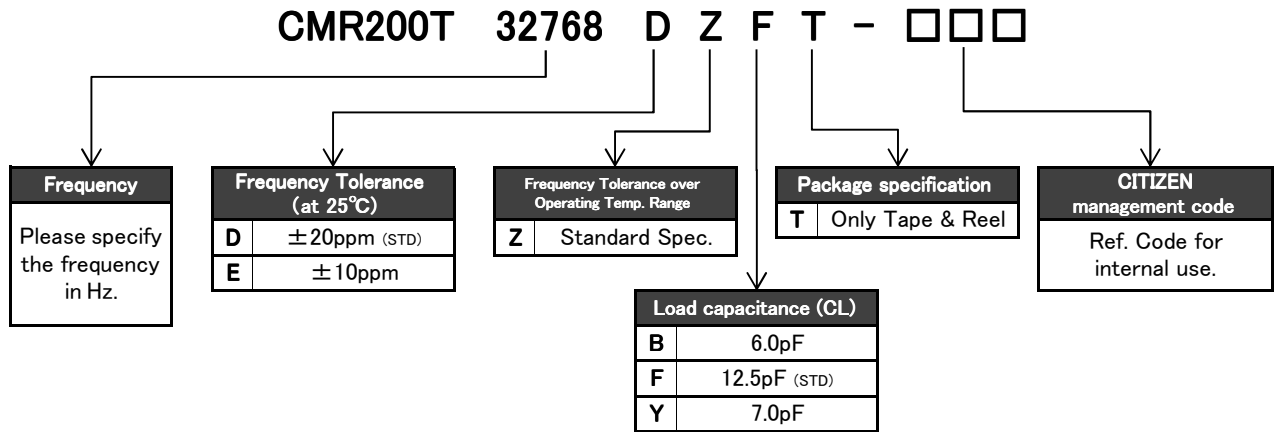

\*Please contact us for specifications available.

## ■ Part Marking [standard]

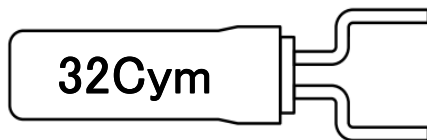

32C : Manufacture's ID Code

y : The last digit of production year

m : Production month (See Table.1)

Table.1

Month	Jan	Feb	...	Sep	Oct	Nov	Dec
Code	1	2	...	9	X	Y	Z

## ■ Reflow profile

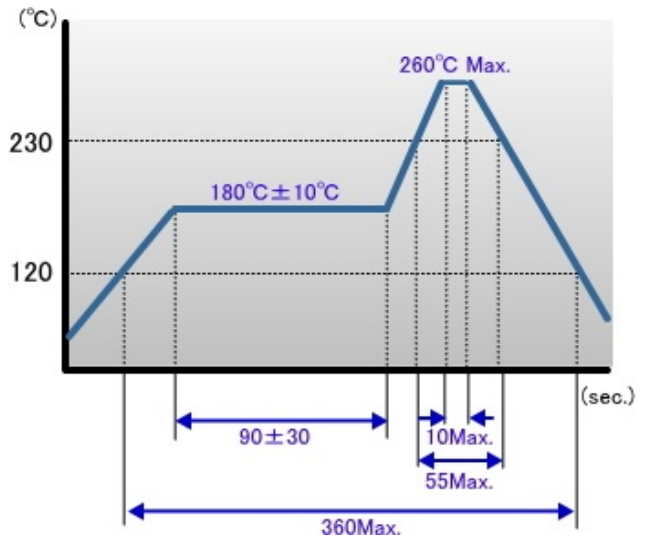

## ■ Packing

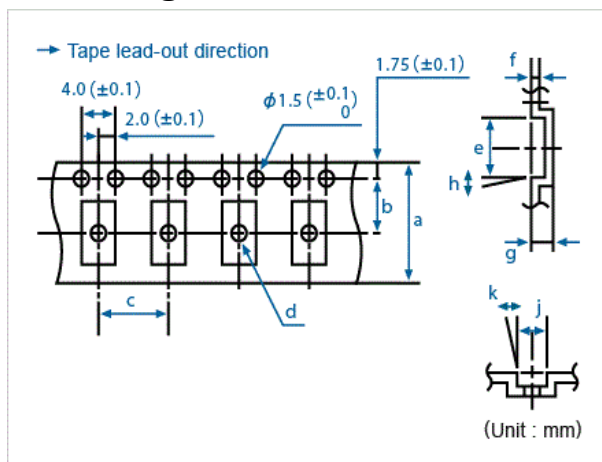

Conforming to JIS C 0806 TB1208NEIAJ and RC-1009B TE1208N

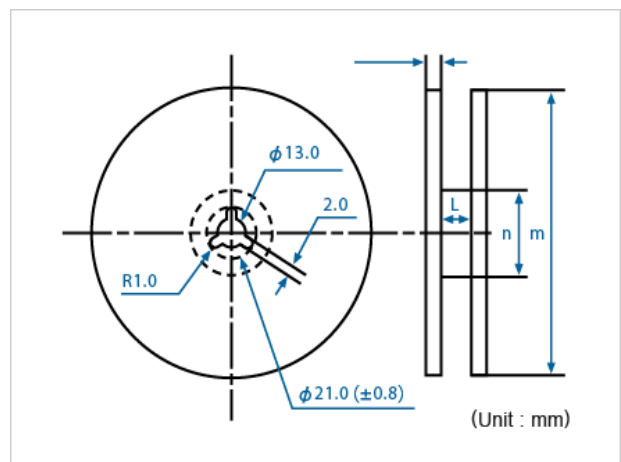

Conforming to JIS C 0806 R12R and EIAJ RC-1009B R15

Q'ty/reel	a	b	c	d (φ)	e	f	g	h	j	k	l	m (φ)	n (φ)
2,000	16.0	7.5	8.0	-	9.4	0.3	2.15	-	5.0	-	17.5	330	100

Rev.1