

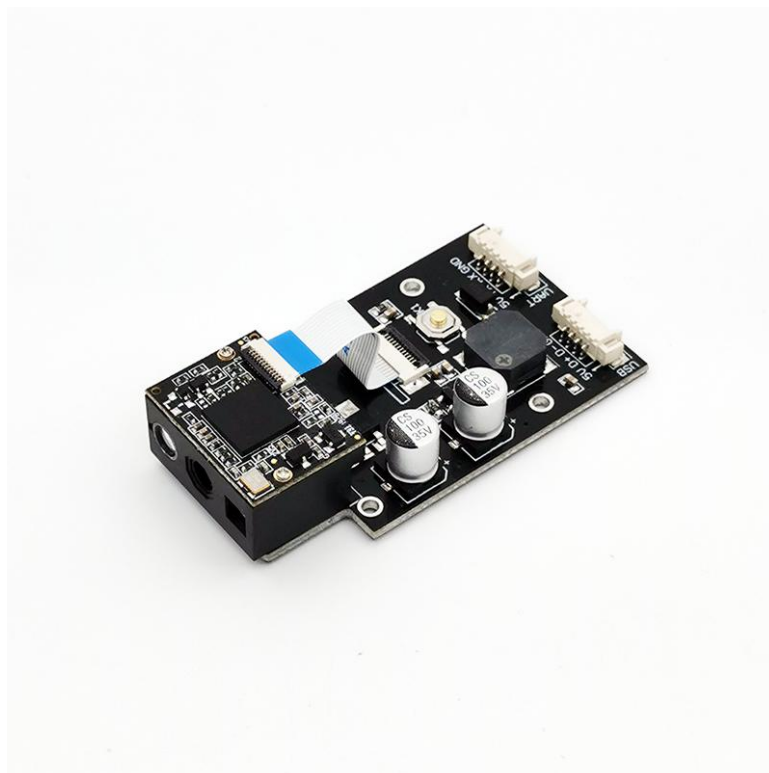

GM69 Bar Code Reader Module User Manual



Hangzhou Grow Technology Co., Ltd.
V1.3 Oct. 2020

Catalog

1 Introduction of Module	1
1.1 Introduction	1
1.2 Technical Specification	1
1.3 Dimension (mm)	2
1.4 Scan Head Definition	3
1.5 Circuit Board Communication Interface	4
1.6 Scanning Area Map	5
1.7 Readable Barcode Type	5
2 Factory Mode Information	7
2.1 Factory Default Configuration	7
2.2 Setup Code	7
3 Communication Interface	8
3.1 Serial Port	8
3.1.1 Baud rate	8
3.1.2 Parity Bit	9
3.1.3 Stop Bit	9
3.1.4 Software Shake Hand	9
3.2 USB KBW	9
3.3 USB COM Keyboard	9
4 Read Mode	10
4.1 Manual Mode	10
4.1.1 Button Holding Mode	10
4.1.2 Button Trigger Mode	10
4.2 Continuous Mode(Default)	10
4.2.1 Break Time Settlement	11
4.3 Induction Mode	11
4.3.1 Stable Induction Time	11
4.3.2 Sensitivity Rating Setting	12
4.4 Host Mode	12
4.5 Single Scan Time	12

4.5.1 Single Scan Time Quickly Set Up	13
4.6 Time Interval For The Same Code Read	13
4.6.1 Same Code Quickly Set Up	13
5 Lighting and Collimate	14
5.1 Lighting	14
5.2 Collimation	14
6 Prompts	15
6.1 Keyboard	15
6.1.1 Keyboard Settlement	15
6.1.2 Keyboard Type	16
6.1.3 Keyboard Output Character Time Interval	17
6.1.4 ASCII Control Character Output Mode Selection	17
6.2 Prompts Tone	18
6.2.1 Buzzer Type	18
6.2.2 Silent Mode	18
6.2.3 Volume Level	18
6.2.4 Decoding Successful Prompt Tone	18
6.2.5 Starting Up Prompt	18
6.2.6 Setup Code Prompt	19
6.3 Decoding Successful Prompt Light	19
6.4 Decoding Prompt Working Mode	19
6.5 Decoding Prompt	19
6.6 Keyboard Output Force Letter Case Conversion	20
6.7 Output Data Code Format	20
6.8 Input Data Code Format	21
7 Data Edition	22
7.1 CODE ID	22
7.2 Terminator Character	22
7.3 Add Prefix and Suffix	23
7.3.1 Prefix	23
7.3.2 Suffix(Similar to a prefix, you can add a newline to suffix if you need a newline)	23
7.3.3 Prefix Suffix Take Effect	24
7.4 Hide Header, Middle and Tail Characters	24

7.4.1 Hide Header Characters	24
7.4.2 Hide Middle Characters	25
7.4.3 Hide Tail Characters	26
7.5 Set STX and ETX	26
7.6 Any Character Replacement Function	27
7.6.1 First scan "Set the Replaced Object"	27
7.6.2 Scan "Set Replacement Data"	27
7.6.3 Complete Setting	27
7.6.4 Scan "Allow Data Replacement" to Enable the Replacement Function	27
8 All Types of Bar Code Can be Decoded	28
8.1 Global Enable Switch	28
8.2 1D Code Global Enable Switch	28
8.3 2D Code Global Enable Switch	28
8.4 Forward and backward reading	28
8.5 UPC-A	29
8.5.1 UPC-A	29
8.5.2 UPC-A Leading Code	29
8.5.3 UPC-A Check Bit	29
8.6 UPC-A Extra Code	29
8.6.1 UPC-A 2-bit Extra Code	29
8.6.2 UPC-A 5-bit Extra Code	30
8.6.3 UPC-A Extra Code Must be Identified	30
8.7 UPC-E	30
8.7.1 UPC-E	30
8.7.2 UPC-E Leading Code	30
8.7.3 UPC-E Check Bit	30
8.8 UPC-E Extra Code	31
8.8.1 UPC-E 2-bit Extra Code	31
8.8.2 UPC-E 5-bit Extra Code	31
8.8.3 UPC-E Extra Code Must be Identified	31
8.9 UPC-E Turn UPC-A	31
8.10 UPC-A Turn EAN-13	31
8.11 UPC-E1	32

8.12 EAN-8	32
8.12.1 EAN-8	32
8.12.2 EAN-8 Check Bit	32
8.13 EAN-8 Extra Code	32
8.13.1 EAN-8 2-bit Extra Code	32
8.13.2 EAN-8 5-bit Extra Code	33
8.13.3 EAN-8 Extra Code Must be Identified	33
8.14 EAN-13	33
8.14.1 EAN-13	33
8.14.2 EAN-13 Check Bit	33
8.15 Bookland EAN(ISBN)	34
8.16 EAN-13 Extra Code	34
8.16.1 EAN-13 2-bit Extra Code	34
8.16.2 EAN-13 5-bit Extra Code	34
8.16.3 EAN-13 Extra Code Must be Identified	34
8.17 CODE 128	35
8.18 GS1-128(UCC/EAN-128)	35
8.19 Interleaved 2 of 5	35
8.19.1 2 of 5	35
8.19.2 Interleaved 2 of 5 Identify Length	35
8.19.3 Interleaved 2 of 5 Check Bit Verification	36
8.19.4 Interleaved 2 of 5 Check Bit Transmission	36
8.20 Matrix 2 of 5	36
8.20.1 Matrix 2 of 5	36
8.20.2 Matrix 2 of 5 Identify Length	36
8.20.3 Matrix 2 of 5 Check Bit Verification	37
8.20.4 Matrix 2 of 5 Check Bit Transmission	37
8.21 Industrial 2 of 5	37
8.21.1 Industrial 2 of 5	37
8.21.2 Industrial 2 of 5 Identify Length	37
8.22 Standard 2 of 5	38
8.22.1 Standard 2 of 5	38
8.22.2 Standard 2 of 5 Identify Length	38

8.23 Code 39	39
8.23.1 Code 39	39
8.23.2 Code 39 Length	39
8.23.3 Code 39 Check Bit Verification	39
8.23.4 Code 39 Check Bit	39
8.23.5 Code39 Transmit Start Character and Stop Character	39
8.24 Code 39 Full ASCII	40
8.25 Code 32	40
8.25.1 Code 32	40
8.25.2 Code 32 Add the Prefix A	40
8.26 Code 93	40
8.26.1 Code93	40
8.26.2 Code93 Length	41
8.27 Code 11	41
8.27.1 Code 11	41
8.27.2 Code 11 Length	41
8.27.3 Code 11 Check Bit Verification	41
8.27.4 Code 11 Check Bit Transmission	41
8.28 Codabar	42
8.28.1 Codabar	42
8.28.2 Codabar Length	42
8.28.3 Start and End Character Formats	42
8.28.4 Start and End Character Send	42
8.29 MSI	43
8.29.1 MSI	43
8.29.2 MSI Length	43
8.30 GS1-Databar	43
8.31 GS1 Composite Code	43
8.32 QR Code	44
8.32.1 QR Code	44
8.32.2 Forward and Backward Reading	44
8.33 Data Matrix	44
8.33.1 Data Matrix	44

8.33.2 Forward and Backward Reading	44
8.34 PDF 417	45
8.34.1 PDF 417	45
8.35 Aztec Code	45
8.36 Maxi Code	45
8.37 Han Xin Codes	45
8.38 Mirror	46
8.38.1 QR Mirror	46
8.38.2 DM Mirror	46
Appendix 1: Digital Setting Code	47
Appendix 2: Cancel Barcode	48
Appendix 3: Code ID	49
Appendix 4: Character Comparison Table	50
Appendix 5: Supported Barcode Type	55
Appendix 6: Serial Port Instruction	56

1 Introduction of Module

1.1 Introduction

GM69 1D 2D barcode scanner, with high integration and compact size, can be easily integrated into various industrial equipment and application environments. It can not only read various 1d barcode easily, but also read 2d barcode at high speed. It has a very high scanning rate for linear bar codes. For barcode on paper and screen, can also be easily scanned.



1.2 Technical Specification

Scanning Performance	Scan Mode		1280*800 CMOS		
	Lighting		White LED		
	Collimate		Red LED		
	Read Code Type	2D	QR Code, Data Matrix, PDF417, Aztec, Micro QR, Micro PDF417, Maxicode, Hanxin Code		
		1D	EAN, UPC, Code 39, Code 93, Code 128, UCC/EAN 128, Codabar,		
			Interleaved 2 of 5, ITF-6, ITF-14, ISBN, ISSN, MSI-Plessey		
			GS1 Databar, Code 11, Industrial 25, GS1 Composite		
			Standard 25, Plessey, Matrix 2 of 5		
	Accuracy of reading		1D ≥ 4mil, 2D ≥ 7.54mil		
	Depth of Field	EAN-13	35mm-220mm (13mil 13byte)		
		Code 39	30mm-135mm (5mil 4 byte)		
		QR Code	45mm-460mm (20mil 16 byte)		
		Data Marix	25mm-180mm (10mil 20 byte)		
PDF417		30mm-160mm (6.67mil 7 byte)			
Contrast		≥25%			
Scanning angle		Intersection angle 360°, Elevation ± 55° Deflection angle ± 55°			
Viewing Angle		H:52° V:38°			

Mechanical/ Electrical Parameters	Interface	TTL-232 , USB (HID-KBW, Virtual serial port)
	Dimension	54.8(W)*31.5(D)*13(H)mm
	Operating Voltage	DC 5 V
	Operating Current	180mA
	Standby Current	USB:25mA; TTL:10mA
Environmental Parameters	Operating Temperature	-20°C~+50°C
	Storage Temperature	-40°C~+70°C
	Operating Humidity	5%~95% (Non-Condensing)
	Environmental Light	0~100000LUX

1.3 Dimension (mm)

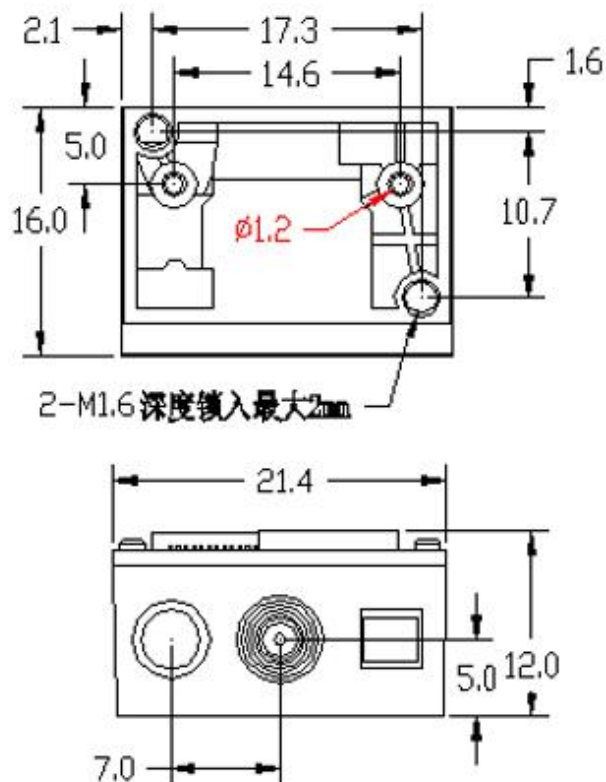

Circuit Board Diagram:

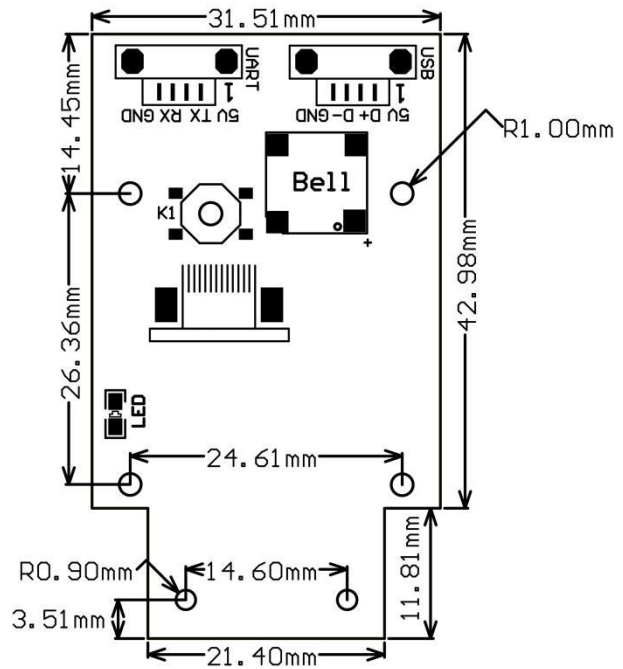
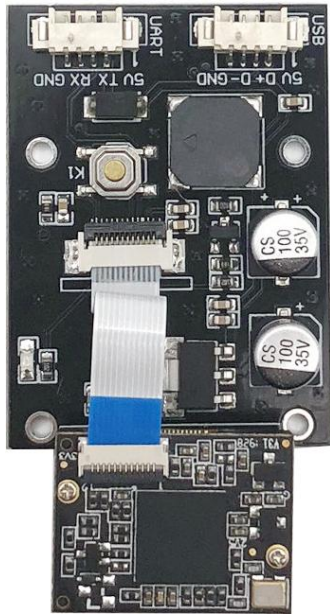

1.4 Scan Head Definition

The cable is 12PIN directly connected with FPC flexible line, with an interval of 0.5mm

PIN	Input/Output	Definition	Introductions
PIN 1	-	NC	Dangling
PIN 2	Power	VCC	Input+3.3V
PIN 3	Ground	GND	-
PIN 4	Input	RX	Serial port receiver signal
PIN 5	Output	TX	Serial port send signal
PIN 6	Input	D-	USB : D-singal
PIN 7	Output	D+	USB : D+singal
PIN 8	-	NC	-
PIN 9	Output	BEEPER	sfn output, low level when free
PIN10	Output	DLED	Decoding success light, low level when free
PIN11	-	NC	-
PIN12	Input	TRIG	Weak Pull-up, Low level trigger engine decoding

1.5 Circuit Board Communication Interface

UART Communication interface definition:

Pin	Name	Definition	Description
1	5V	Power Input	Power input 5V
2	TX	Out	Data output. TTL logical level
3	RX	In	Data input. TTL logical level
4	GND	-	Signal ground

USB Communication interface definition:

Pin	Name	Definition	Description
1	5V	Power Input	Power input 5V
2	D+	Out	USB data output
3	D-	In	USB data input
4	GND	-	Signal ground

1.6 Scanning Area Map

Target area 4° , Viewl angle 52° , lighting area 90°

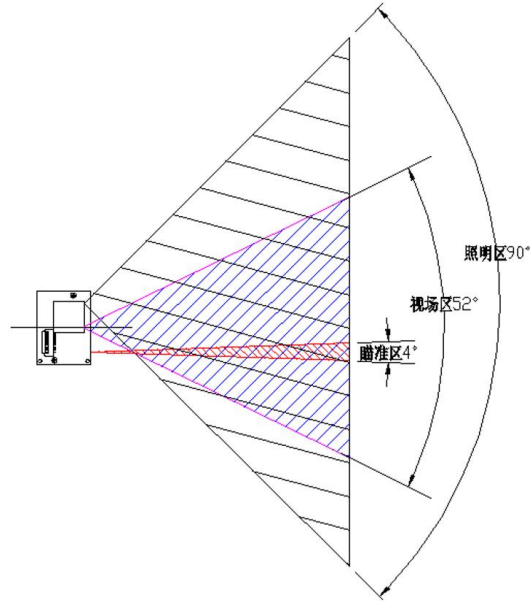

1.7 Readable Barcode Type

Type	Readable	Default
UPC/EAN	✓	✓
Code 128/EAN128	✓	✓
GS1-128	✓	✓
ISBT-128	✓	✓
Standard 2 of 5	✓	x
Interleaved 2 of 5	✓	✓
Industrial 2 of 5	✓	x
Matrix 2 of 5	✓	x
Code 39	✓	✓
Code 32	✓	x
Code 93	✓	x
Code 11	✓	x
Codabar	✓	x

PLESSEY	✓	x
MSI	✓	x
GS1 Databar	✓	x
ITF-14	✓	x
GS1 Composite	✓	x
QR code	✓	✓
Data Matrix	✓	✓
PDF417	✓	✓
Aztec	✓	x
Micro QR	✓	✓
Micro PDF417	✓	✓
Maxicode	✓	x
Hanxin Code	✓	x

2 Factory Mode Information

2.1 Factory Default Configuration



Factory default setting

2.2 Setup Code



*Setup code on



Off

3 Communication Interface

3.1 Serial Port

It's default and common to connect module and mainframe(such as PC, POS) by serial communication interface. Make sure communication parameter for module and mainframe are same, then it will communicate smooth and correctly. **Serial port related configuration: Baud rate:9600, Data bit:8, Verification: No, Stop bit:1**



TTL 232 Interface

3.1.1 Baud rate



1200bps



2400bps



4800bps



*9600bps(Default)



19200bps



38400bps



57600bps



115200bps

3.1.2 Parity Bit



Odd number



Even number



*No parity

3.1.3 Stop Bit



*1 bit stop bit



2 bit stop bit

3.1.4 Software Shake Hand



Forbid ACK/NAK



*Allow ACK/NAK

3.2 USB KBW



USB KBW Keyboard

3.3 USB COM Keyboard



USB COM

4 Read Mode

4.1 Manual Mode

4.1.1 Button Holding Mode

Set to button holding mode, press the button to trigger reading, and release the button to end reading. If the reading is successful or the reading time exceeds the single reading time, the reading will be finished.



Manual Mode- Button Holding

4.1.2 Button Trigger Mode

Set to the button trigger mode, press the button to start reading, release the button, read will not stop. If the reading is successful or the reading time exceeds the single reading time, the reading will be finished.



Manual Mode- Button Trigger

4.2 Continuous Mode(Default)

On this mode, reading module read code continuous and automatic. Read successfully or the reading time exceeds the single reading time,the reading will be finished,and automatically trigger the next reading.



***Continuous Mode**

4.2.1 Break Time Settlement

Time between two read.

Default:500ms, Unit:100ms, Range:0-9900ms

You can set the break time by scanning the bar code, example:

Set 0.5ms, first scan the bar code below. Then scan the “0” and “5” bar code in the Digital Setting Code (Appendix 1).



Break time settlement

4.3 Induction Mode

In automatic sensing mode, the reading engine detects the brightness of the surrounding environment. When the brightness changes, module will begin to read, read successfully or the reading time exceeds the single reading time, the reading will be finished. Regardless of the last read success or failure, the module will be redetects the brightness of the surrounding environment.



Induction Mode

4.3.1 Stable Induction Time

Stable time before entering the test environment. Default: 500ms, Unit:100ms, Range:0-9900ms

You can set the stable time by scanning the bar code, example:

Set 200ms, first scan the bar code below. Then scan the “0” and “2” bar code in the Digital Setting Code (Appendix 1).

Set 1500ms, first scan the bar code below. Then scan the “1” and “5” bar code in the Digital Setting Code (Appendix 1).



Stable Induction Time

4.3.2 Sensitivity Rating Setting

There are three levels of sensitivity to choose from, default: high sensitivity.



*High Sensitivity



Medium Sensitivity



Low Sensitivity

4.4 Host Mode

Through the instruction to trigger the reading engine, and it can end the reading by instruction, read successfully or the reading time exceeds the single reading time, the reading will be finished.

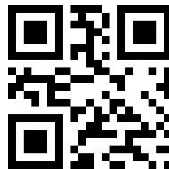

Host Mode

4.5 Single Scan Time

This parameter is the duration of a single decoding. Time from 0.5s to 25.5s, step size 0.1s. **Default 3s.** Example:

Set 0.5s, first scan the bar code below. Then scan the “0”, “0” and “5” bar code in the Digital Setting Code (Appendix 1).

Set 10.5s, first scan the bar code below. Then scan the “1”, “0” and “5” bar code in the Digital Setting Code (Appendix 1).



Single scan time

4.5.1 Single Scan Time Quickly Set Up



Infinite



3s



5s



10s



15s



20s

4.6 Time Interval For The Same Code Read

It means, after reading a barcode, refuse to read the same code for a set period of time. Only after a set period of time, it can be able to read and output. Default: 500ms, Unit:100ms, Range:0-9900ms.

Mainly for continuous mode and automatic induction mode.

Example: Set 0.5s, first scan the bar code below. Then scan the “0” and “5” bar code in the Digital Setting Code (Appendix 1).



Time Interval For The Same Code Read

4.6.1 Same Code Quickly Set Up



No delay



Delay 1s



Delay 3s



Delay 5s



Delay 7s



Infinite delay

5 Lighting and Collimate

5.1 Lighting

Head lamp is used to additional lighting when read.



*The light turn on only when read
(Default)



Always on



Always off

5.2 Collimation

There will be a pointing light beam which can help user to find best distance.

Note: Flashing and non-flashing functions only work if the collimation LED is set to be **Always on** or **on when read**. After the LED is set to be off, if you want to set the LED flashing function, please first set the collimation LED to be **Always on** or **on when reading**.



*The light turn on only when read
(Default)



Always on



Always off



Flashing



Non-Flashing

6 Prompts

6.1 Keyboard

6.1.1 Keyboard Settlement

Scan following code to change keyboard.



*American English(Default)



Belgium



Finland



Austria,Germany



France



Italy



Sweden



UK



Denmark



Spain



Norway



Portugal



Turkey F



Turkey Q



Japan



Russia



Czech

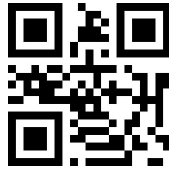

Thailand



Ukraine



Brazil(ABNT2)



Greek



Hungary



Netherlands



Poland(214)



Romania (standard)



Slovakia



Multi-country General

6.1.2 Keyboard Type

After enabling the virtual keyboard, you can output the correct data in any keyboard language mode.

When using virtual keyboard, you must make sure the keypad number keys are valid.



*Standard Keyboard



Virtual Keyboard

6.1.3 Keyboard Output Character Time Interval

Time from 0ms to 1000ms Unit: 5ms Default: 5ms



0ms



10ms

6.1.4 ASCII Control Character Output Mode Selection

Control character (0x00-0x20) output mode selection in ASCII code

Output function keys: control characters are used as custom function keys. See appendix 4 for specific functions

Output Ctrl combination key (this function is used with prefix and suffix) : Ctrl combination key output control characters, specific functions are shown in appendix 4

ALT output control characters: full control character output is supported in Chinese environment, refer to standard ASCII table for details

Output Enter and DownArrow: mask other control characters, output only: 0x07 output Enter, 0x0A output DownArrow, 0x0D output Enter.



Output function keys(0x00)



Output Ctrl combination key(0x01)



ALT output control characters(0x02)



Output Enter and DownArrow(0x03)

6.2 Prompts Tone

6.2.1 Buzzer Type



*Passive Buzzer



Active Buzzer

6.2.2 Silent Mode



Close All Prompts



*Forbid to Close All Prompts

6.2.3 Volume Level

Default: high pitch



*High Pitch



Middle



Low

6.2.4 Decoding Successful Prompt Tone



*Decoding Successful Prompt Tone ON



Decoding Successful Prompt Tone OFF

6.2.5 Starting Up Prompt



***Starting Up Prompt ON**



Starting Up Prompt OFF

6.2.6 Setup Code Prompt



***Setup Code Prompt ON**



Setup Code Prompt OFF

6.3 Decoding Successful Prompt Light

Decoding success prompt light on a certain time, the premise is that the prompt light is used as a decoding prompt.



Forbid



***Allow**

6.4 Decoding Prompt Working Mode



***Power on Always off**



Power on Always on

6.5 Decoding Prompt

If the barcode cannot be decoded within the timeout period before releasing the trigger button, it is allowed to send "unread" messages. Any possible prefix or suffix can be attached to this message.

When this function is disabled, no message can be sent to the host even if the barcode cannot be decoded.



***Forbid sending NR**



Allow sending NR

6.6 Keyboard Output Force Letter Case Conversion

Example: If the barcode is ab123dE, if scan the "convert to uppercase" bar code, the output is AB123DE; if scan the "convert to lowercase" bar code, the output is abc123de.

Default: Keyboard case is not converted.



***Keyboard case is not converted**



All uppercase



All lowercase



Case reversal

6.7 Output Data Code Format

Read following to print Chinese data according to specified code format

0: Original type 1:GBK format: notepad, EXCEL

2: UNICODE format: WORD and input box for chat tools



Original Type



***GBK**



Unicode

6.8 Input Data Code Format



***AUTO**
(0x00)



GBK(GB2312)
(0x01)



UTF8
(0x02)



ASCII
(0x03)



Japanese



DEC Multinational Character Set(MCS)



Japanese single byte

7 Data Edition

7.1 CODE ID

Users can identify different types of bar code by CODE ID.

CODE ID use one character to identify and can be self- defined. Pls see the Appendix 3.



***Not allowed to send ID**



Allowed to send ID

7.2 Terminator Character

Terminator character is add character format after decoding data: decoded data + terminator character.



***No Terminator**



#&CR LF



%CR



TAB



CR CR



CR LF CR LF

7.3 Add Prefix and Suffix

7.3.1 Prefix

- 1) Scan "Set Multiple Prefixes" setting code



Set Multiple Prefixes in succession

- 2) Scan the digital setting code in turn, and there will be a successful tone for every four
- 3) Scan "Finish Setting Multiple Prefixes Suffixes" setting code and finish setting



Finish Setting Multiple Prefixes Suffixes

7.3.2 Suffix(Similar to a prefix, you can add a newline to suffix if you need a newline)

- 1) Scan "Set Multiple Suffixes" setting code



Set Multiple Suffixes in succession

- 2) Set Suffixes
- 3) Scan "Finish Setting Multiple Prefixes Suffixes" setting code and finish setting



Finish Setting Multiple Prefixes Suffixes

7.3.3 Prefix Suffix Take Effect



*Only output the decoded data



Output multiple Suffixes



Output multiple Prefixes



Output multiple Prefixes and Suffixes

7.4 Hide Header, Middle and Tail Characters

7.4.1 Hide Header Characters

Decoding data for header data hiding, it can be configured to hide any length.

If the configured length exceeds the barcode data length, all contents of the current barcode are hidden



*Forbid



Allow

Set the number of Hide Header Characters

Set the number of Hide Header Characters, ranging from 1 to 255.

Scan the follow barcode and then scan the digital setting code. For example, if 16 characters need to be hidden, then scan the digital setting code sequentially: 0, 1 and 6.



The number of Hide Header Characters

7.4.2 Hide Middle Characters

Decoding data for middle data hiding, and any starting position and length can be configured.

If the starting position of the configuration exceeds the barcode data length, the current barcode is not hidden.

If the configured length exceeds the remaining barcode data length, all barcode data after the start location is hidden.



***Forbid**



Follow

Sets the Start Location of Hide Middle Characters

Sets the start location of hide middle characters, ranging from 1 to 255.

Scan the follow barcode and then scan the digital setting code. For example, if you need to hide data after the third character (starting with the fourth character), scan the digital setting code successively: 0 0 3.



The start bit of Hide Middle Characters

Sets the Length of Hide Middle Characters

Sets the length of hide middle characters, ranging from 1 to 255.

Scan the follow barcode and then scan the digital setting code. For example, if 16 characters need to be hidden, then scan the digital setting code sequentially: 0, 1 and 6.



The Length of Hide Middle Characters

7.4.3 Hide Tail Characters

Decoding data for tail data hiding, it can be configured to hide any length.

If the configured length exceeds the barcode data length, all contents of the current barcode are hidden.



***Forbid**



Follow

Set the number of Tail Header Characters

Set the number of Tail Header Characters, ranging from 1 to 255.

Scan the follow barcode and then scan the digital setting code. For example, if 16 characters need to be hidden, then scan the digital setting code sequentially: 0, 1 and 6.



The number of Tail Header Characters

7.5 Set STX and ETX



Forbid



STX Prefix



ETX Suffix 1



STX(Prefix)+ETX(Suffix 1)

7.6 Any Character Replacement Function

This function can replace any character in barcode data with another character, supporting data number 1:1 or 1:n replacement, such as the replacement of A--B, A--BC, A--BCD...

Operation brief Description:

7.6.1 First scan "Set the Replaced Object"



Set the Replaced Object

For example: Separator GS, corresponding digital setting code is 1029, respectively scan 1,0,2,9

7.6.2 Scan "Set Replacement Data"



Set Replacement Data

For example: Symbol }, corresponding digital setting code is 1125, respectively scan 1,1,2,5

7.6.3 Complete Setting



Complete Setting

7.6.4 Scan "Allow Data Replacement" to Enable the Replacement Function



Allow Replacement



Forbid Replacement

8 All Types of Bar Code Can be Decoded

8.1 Global Enable Switch



Allow



Forbid

8.2 1D Code Global Enable Switch



Allow



Forbid

8.3 2D Code Global Enable Switch



Allow



Forbid

8.4 Forward and backward reading



Allow



Forbid

8.5 UPC-A

8.5.1 UPC-A



***Allow**



Forbid

8.5.2 UPC-A Leading Code



No Leading Code



***System Characters (Default)**



System Character & Country Code

8.5.3 UPC-A Check Bit



UPC-A Check bit is not transmitted



***Transmit UPC-A Check bit**

8.6 UPC-A Extra Code

8.6.1 UPC-A 2-bit Extra Code



Allow



***Forbid**

8.6.2 UPC-A 5-bit Extra Code



Allow



*Forbid

8.6.3 UPC-A Extra Code Must be Identified



Allow



*Forbid

8.7 UPC-E

8.7.1 UPC-E



*Allow



Forbid

8.7.2 UPC-E Leading Code



*No Leading Code



System Characters (Default)



System Character & Country Code

8.7.3 UPC-E Check Bit



UPC-E Check bit is not transmitted



*Transmit UPC-E Check bit

8.8 UPC-E Extra Code

8.8.1 UPC-E 2-bit Extra Code



Allow



*Forbid

8.8.2 UPC-E 5-bit Extra Code



Allow



*Forbid

8.8.3 UPC-E Extra Code Must be Identified



Allow



*Forbid

8.9 UPC-E Turn UPC-A



Allow



*Forbid

8.10 UPC-A Turn EAN-13



Allow



*Forbid

8.11 UPC-E1



Allow



Forbid

8.12 EAN-8

8.12.1 EAN-8



*Allow



Forbid

8.12.2 EAN-8 Check Bit



Forbid



Allow

8.13 EAN-8 Extra Code

8.13.1 EAN-8 2-bit Extra Code



Allow



*Forbid

8.13.2 EAN-8 5-bit Extra Code



Allow



*Forbid

8.13.3 EAN-8 Extra Code Must be Identified



Allow



*Forbid

8.14 EAN-13

8.14.1 EAN-13



*Allow



Forbid

8.14.2 EAN-13 Check Bit



Forbid



*Allow

8.15 Bookland EAN(ISBN)

When ISBN are forbidden, they are treated as EAN13



Allow (0x01)



*Forbid (0x00)

8.16 EAN-13 Extra Code

8.16.1 EAN-13 2-bit Extra Code



Allow



*Forbid

8.16.2 EAN-13 5-bit Extra Code



Allow



*Forbid

8.16.3 EAN-13 Extra Code Must be Identified



Allow



*Forbid

8.17 CODE 128



***Allow**



Forbid

8.18 GS1-128(UCC/EAN-128)



***Allow**



Forbid

8.19 Interleaved 2 of 5

8.19.1 | 2 of 5



***Allow**



Forbid

8.19.2 Interleaved 2 of 5 Identify Length

Users can set to decode Interleaved 2 of 5 within a certain length range.

Example:Set to decode only Interleaved 2 of 5 within 4-20 bit length range.

First scan the bar code below, and then scan 0,4,2,0 bar code in Appendix 1 in sequence. Change the selection or cancel an incorrect input setting, scan the bar code in Appendix 2.



Industrial 2 of 5 within a certain length range



Industrial 2 of 5 in any length range

8.19.3 Interleaved 2 of 5 Check Bit Verification



Allow



*Forbid

8.19.4 Interleaved 2 of 5 Check Bit Transmission



Allow



*Forbid

8.20 Matrix 2 of 5

8.20.1 Matrix 2 of 5



Allow



*Forbid

8.20.2 Matrix 2 of 5 Identify Length

Users can set to decode Matrix 2 of 5 within a certain length range.

Example: Set to decode only Matrix 2 of 5 within 4-20 bit length range.

First scan the bar code below, and then scan 0,4,2,0 bar code in Appendix 1 in sequence. Change the selection or cancel an incorrect input setting, scan the bar code in Appendix 2.



Matrix 2 of 5 within a certain length range



Matrix 2 of 5 in any length range

8.20.3 Matrix 2 of 5 Check Bit Verification



Allow



*Forbid

8.20.4 Matrix 2 of 5 Check Bit Transmission



Allow



*Forbid

8.21 Industrial 2 of 5

8.21.1 Industrial 2 of 5



Allow



*Forbid

8.21.2 Industrial 2 of 5 Identify Length

Users can set to decode Industrial 2 of 5 within a certain length range.

Example: Set to decode only Industrial 2 of 5 within 4-20 bit length range.

First scan the bar code below, and then scan 0,4,2,0 bar code in Appendix 1 in sequence. Change

the selection or cancel an incorrect input setting, scan the bar code in Appendix 2.



Industrial 2 of 5 within a certain length range



Industrial 2 of 5 in any length range

8.22 Standard 2 of 5

8.22.1 Standard 2 of 5



Allow



***Forbid**

8.22.2 Standard 2 of 5 Identify Length

Users can set to decode Standard 2 of 5 within a certain length range.

Example: Set to decode only Standard 2 of 5 within 4-20 bit length range.

First scan the bar code below, and then scan 0,4,2,0 bar code in Appendix 1 in sequence. Change the selection or cancel an incorrect input setting, scan the bar code in Appendix 2.



Standard 2 of 5 within a certain length range



Standard 2 of 5 in any length range

8.23 Code 39

8.23.1 Code 39



*Allow



Forbid

8.23.2 Code 39 Length



Can solve for any length of code39

8.23.3 Code 39 Check Bit Verification



Verification check bit



*Check bits are not validated

8.23.4 Code 39 Check Bit



Transmission Check Bit



*No check bits are transmitted

8.23.5 Code39 Transmit Start Character and Stop Character



Allow



*Forbid

8.24 Code 39 Full ASCII



Allow



*Forbid

8.25 Code 32

8.25.1 Code 32



Allow



*Forbid

8.25.2 Code 32 Add the Prefix A



Allow



*Forbid

8.26 Code 93

8.26.1 Code93



Allow



*Forbid

8.26.2 Code93 Length



Can read for any length of code93

8.27 Code 11

8.27.1 Code 11



Allow



*Forbid

8.27.2 Code 11 Length



Can solve for any length of code11

8.27.3 Code 11 Check Bit Verification



Allow



One check bit



Two check bit

8.27.4 Code 11 Check Bit Transmission



Allow



*Forbid

8.28 Codabar

8.28.1 Codabar



Allow



*Forbid

8.28.2 Codabar Length



Can solve for any length of Codabar

8.28.3 Start and End Character Formats

T initiators and terminators are allowed to be one of the four characters: "A", "B", "C", "D";The terminator is also allowed to be one of the four characters "T", "N", "*", "E".



*ABCD/ABCD



ABCD/TN*E

8.28.4 Start and End Character Send



Remove the start and stop characters



*Allow start and stop characters

8.29 MSI

8.29.1 MSI



Allow



*Forbid

8.29.2 MSI Length



Can read for any length of MSI

8.30 GS1-Databar



Allow



*Forbid

8.31 GS1 Composite Code



Allow



*Forbid

8.32 QR Code

8.32.1 QR Code



***Allow**



Forbid

8.32.2 Forward and Backward Reading



***Only read Forward**



Forward and Backward both can read

8.33 Data Matrix

8.33.1 Data Matrix



***Allow**



Forbid

8.33.2 Forward and Backward Reading



Only read Forward



Only read Backward



Forward and Backward both can read

8.34 PDF 417

8.34.1 PDF 417



*Allow



Forbid

8.35 Aztec Code



Allow



*Forbid

8.36 Maxi Code



Allow



*Forbid

8.37 Han Xin Codes



Allow



*Forbid

8.38 Mirror

8.38.1 QR Mirror



*Forbid



Allow

8.38.2 DM Mirror



*Forbid



Allow

Appendix 1: Digital Setting Code



0



1



2



3



4



5



6



7



8



9

Appendix 2: Cancel Barcode

Change the selection or cancel an incorrect input, scan the bar code below.



Cancel

Appendix 3: Code ID

Code Characters	Bar code Type
A	UPC-A, UPC-E, EAN-8, EAN-13
B	Code 39, Code 32
C	Codabar
D	Code 128, ISBT 128
E	Code 93
F	Interleaved 2 of 5/ITF, ITF14
G	Industrial 2 of 5, Standard 2 of 5
H	CODE11
J	MSI, MSI/Plessey
K	UCC/EAN-128/GS1-128
L	Bookland EAN/ISBN, ISSN
R	GS1 DataBar-14, GS1 DataBar Limited, GS1 DataBar Expanded, RSS
V	Matrix 25
r	PDF417
u	DataMatrix(DM)
q	QR
a	Aztec Code
x	Maxi Code
c	HanXin

Appendix 4: Character Comparison Table

Scan Value	Hexadecimal value	Keyboard Operation	Keyboard+Ctrl Operation
1000	00h	Null	CTRL 2
1001	01h	Keypad Enter	CTRL A
1002	02h	Caps lock	CTRL B
1003	03h	Right Arrow	CTRL C
1004	04h	Up Arrow	CTRL D
1005	05h	Null	CTRL E
1006	06h	Null	CTRL F
1007	07h	Enter	CTRL G
1008	08h	Left Arrow	CTRL H
1009	09h	Horizontal Tab	CTRL I
1010	0Ah	Down Arrow	CTRL J
1011	0Bh	Vertical Tab	CTRL K
1012	0Ch	Backspace	CTRL L
1013	0Dh	Enter	CTRL M
1014	0Eh	Insert	CTRL N
1015	0Fh	Esc	CTRL O
1016	10h	F11	CTRL P
1017	11h	Home	CTRL Q
1018	12h	Print Screen	CTRL R
1019	13h	Delete	CTRL S
1020	14h	tab+shift	CTRL T
1021	15h	F12	CTRL U
1022	16h	F1	CTRL V
1023	17h	F2	CTRL W
1024	18h	F3	CTRL X
1025	19h	F4	CTRL Y
1026	1Ah	F5	CTRL Z
1027	1Bh	F6	CTRL [

1028	1Ch	F7	CTRL \
1029	1Dh	F8	CTRL]
1030	1Eh	F9	CTRL 6
1031	1Fh	F10	CTRL -
1032	20h	Space	Space
1033	21h	/A	!
1034	22h	/B	'
1035	23h	/C	#
1036	24h	/D	\$
1037	25h	/E	%
1038	26h	/F	&
1039	27h	/G	'
1040	28h	/H	(
1041	29h	/I)
1042	2Ah	/J	*
1043	2Bh	/K	+
1044	2Ch	/L	,
1045	2Dh	-	-
1046	2Eh	.	.
1047	2Fh	/	/
1048	30h	0	0
1049	31h	1	1
1050	32h	2	2
1051	33h	3	3
1052	34h	4	4
1053	35h	5	5
1054	36h	6	6
1055	37h	7	7
1056	38h	8	8
1057	39h	9	9
1058	3Ah	/Z	:
1059	3Bh	%F	;

1060	3Ch	%G	<
1061	3Dh	%H	=
1062	3Eh	%I	>
1063	3Fh	%J	?
1064	40h	%V	@
1065	41h	A	A
1066	42h	B	B
1067	43h	C	C
1068	44h	D	D
1069	45h	E	E
1070	46h	F	F
1071	47h	G	G
1072	48h	H	H
1073	49h	I	I
1074	4Ah	J	J
1075	4Bh	K	K
1076	4Ch	L	L
1077	4Dh	M	M
1078	4Eh	N	N
1079	4Fh	O	O
1080	50h	P	P
1081	51h	Q	Q
1082	52h	R	R
1083	53h	S	S
1084	54h	T	T
1085	55h	U	U
1086	56h	V	V
1087	57h	W	W
1088	58h	X	X
1089	59h	Y	Y
1090	5Ah	Z	Z
1091	5Bh	%K	[

1092	5Ch	%L	\
1093	5Dh	%M]
1094	5Eh	%N	^
1095	5Fh	%O	_
1096	60h	%W	'
1097	61h	+A	a
1098	62h	+B	b
1099	63h	+C	c
1100	64h	+D	d
1101	65h	+E	e
1102	66h	+F	f
1103	67h	+G	g
1104	68h	+H	h
1105	69h	+I	i
1106	6Ah	+J	j
1107	6Bh	+K	k
1108	6Ch	+L	l
1109	6Dh	+M	m
1110	6Eh	+N	n
1111	6Fh	+O	o
1112	70h	+P	p
1113	71h	+Q	q
1114	72h	+R	r
1115	73h	+S	s
1116	74h	+T	t
1117	75h	+U	u
1118	76h	+V	v
1119	77h	+W	w
1120	78h	+X	x
1121	79h	+Y	y
1122	7Ah	+Z	z
1123	7Bh	%P	{

1124	7Ch	%Q	
1125	7Dh	%R	}
1126	7Eh	%S	~
1127	7Fh		Undefined

Appendix 5: Supported Barcode Type

Barcode Type	Hexadecimal Value	Barcode Type	Hexadecimal Value
Not Applicable	0x00	EAN 13 with 5 Supps.	0x8B
Code 39	0x01	EAN 13	0x0B
Codabar	0x02	EAN 13 with 2 Supps.	0x4B
Code 128, Setup128	0x03	EAN 13 with 5 Supps.	0x8B
Discrete 2 of 5	0x04	MSI	0x0E
IATA 2 of 5	0x05	GS1-128	0x0F
Interleaved 2 of 5	0x06	UPC E1	0x10
Code 93	0x07	UPC E1 with 2 Supps.	0x50
UPC A	0x08	UPC E1 with 5 Supps.	0x90
UPC A with 2 Supps.	0x48	Trioptic Code 39	0x15
UPC A with 5 Supps.	0x88	Bookland EAN	0x16
UPC E0	0x09	Coupon Code	0x17
UPC E0 with 2 Supps.	0x49	GS1 DataBar-14	0x30
UPC E0 with 5 Supps.	0x89	GS1 DataBar Limited	0x31
EAN 8	0x0A	GS1 DataBar Expanded	0x32
EAN 8 with 2 Supps	0x4A	Code11	0x0C
EAN 8 with 5 Supps	0x8A	PDF417	0xF0
QR	0xF1	Data Matrix(DM)	0xF2
Aztec Code	0xF3	Maxi Code	0xF4
Veri Code	0xF5	Han Xin	0xF7
AIM128	0xA2	ISSN	0xA3
PLESSEY	0xA4		

Appendix 6: Serial Port Instruction

When the scanner is not working, it is in sleep mode. Under the sleep mode, need to wake up first, then send the effective command. (Wake up command: 0x00, 50ms, then send the effective command)

To start decoding and stop decoding the serial port command needs to be valid in host mode. Please switch to the host mode first.

Table 6-1

Name	Instructions
CMD_ACK	04 D0 04 00 FF 28
CMD_NAK	RESEND: 05 D1 04 00 01 FF 25 BAD_CONTEXT: 05 D1 04 00 02 FF 24 DENIED: 05 D1 04 00 06 FF 20
DECODE_DATA	None
LED_OFF	05 E8 04 00 01 FF 0E
LED_ON	05 E7 04 00 01 FF 0F
PARAM_DEFAULTS	04 C8 04 00 FF 30
PARAM_REQUEST	Listed in the table below
PARAM_SEND	Listed in the table below
REQUEST_REVISION	04 A3 04 00 FF 55
REPLY_REVISION	None
SCAN_DISABLE	04 EA 04 00 FF 0E
SCAN_ENABLE	04 E9 04 00 FF 0F
SLEEP	04 EB 04 00 FF 0D
START_DECODE	04 E4 04 00 FF 14
STOP_DECODE	04 E5 04 00 FF 13
WAKEUP	None
RESET	04 FA 04 00 FE FE
Custom buzzer sound	05 E6 04 00 00 FF 11 05 E6 04 00 01 FF 10

Table 6-2

Parameter Name	Serial Instructions
Default Configuration	Factory Default Configuration:08 C6 04 08 00 F2 FF 00 FD 35
Scanning duration	4s: 07 C6 04 08 00 88 28 FE 77 10s:07 C6 04 08 00 88 64 FE 3B
Single Scan Time(Scanning duration)Quickly Set Up	Infinite: 08 C6 04 08 00 F2 FA 00 FD 3A 3s: 08 C6 04 08 00 F2 FA 03 FD 37 5s: 08 C6 04 08 00 F2 FA 05 FD 35 10s: 08 C6 04 08 00 F2 FA 0A FD 30 15s: 08 C6 04 08 00 F2 FA 0B FD 2F 20s: 08 C6 04 08 00 F2 FA 0C FD 2E 30s: 08 C6 04 08 00 F2 FA 0D FD 2D 60s: 08 C6 04 08 00 F2 FA 0E FD 2C
Trigger Mode	Button Holding: 07 C6 04 08 00 8A 00 FE 9D Button Trigger: 07 C6 04 08 00 8A 02 FE 9B Continuous scanning: 07 C6 04 08 00 8A 04 FE 99 Automatic Induction: 07 C6 04 08 00 8A 09 FE 94 Host: 07 C6 04 08 00 8A 08 FE 95
Break Time Settlement	0s:07 C6 04 08 00 89 00 FE 9E 0.5s: 07 C6 04 08 00 89 05 FE 99 3s: 07 C6 04 08 00 89 1E FE 80
Buzzer Voice	Low: 07 C6 04 08 00 8C 02 FE 99 Middle: 07 C6 04 08 00 8C 01 FE 9A High: 07 C6 04 08 00 8C 00 FE 9B
Buzzer Type	*Passive Buzzer: 08 C6 04 08 00 F2 D8 00 FD 5C Active Buzzer: 08 C6 04 08 00 F2 D8 01 FD 5B

Decoding Successful Prompt Tone	On: 07 C6 04 08 00 38 01 FE EE Off: 07 C6 04 08 00 38 00 FE EF
Terminator Character Setting	Forbid:08 C6 04 08 00 F2 05 00 FE 2F CR LF:08 C6 04 08 00 F2 05 01 FE 2E CR:08 C6 04 08 00 F2 05 02 FE 2D TAB: 08 C6 04 08 00 F2 05 03 FE 2C CR CR: 08 C6 04 08 00 F2 05 04 FE 2B CR LF CR LF: 08 C6 04 08 00 F2 05 05 FE 2A
Decoding Successful Prompt Light	Forbid: 08 C6 04 08 00 F2 0B 00 FE 29 Allow: 08 C6 04 08 00 F2 0B 01 FE 28
Decoding Prompt Light Control	Power on Always off: 08 C6 04 08 00 F2 CB 00 FD 69 Power on Always on: 08 C6 04 08 00 F2 CB 01 FD 68
Silent	Forbid: 08 C6 04 08 00 F2 0C 00 FE 28 Allow: 08 C6 04 08 00 F2 0C 01 FE 27
Starting Up Prompt	Forbid: 08 C6 04 08 00 F2 0D 00 FE 27 Allow: 08 C6 04 08 00 F2 0D 01 FE 26
Setup Code Prompt	Forbid: 08 C6 04 08 00 F2 0E 00 FE 26 Allow: 08 C6 04 08 00 F2 0E 01 FE 25
Send "Not read" message	On: 07 C6 04 08 00 5E 01 FE C8 Off: 07 C6 04 08 00 5E 00 FE C9
Allows scan configuration bar code	On: 07 C6 04 08 00 EC 01 FE 3A Off: 07 C6 04 08 00 EC 00 FE 3B
Send the Setup Code Information	On: 08 C6 04 08 00 F1 71 01 FD C3 Off: 08 C6 04 08 00 F1 71 00 FD C4
Prefix/Suffix Value Prefix Suffix 1 Suffix 2	Prefix string setting 31 Suffix string setting 32 33 : 0B C6 04 08 00 69 31 68 32 6A 33 FD 52 Prefix:0x00 Suffix 0x0D 0x0A Implement a newline:

	0B C6 04 08 00 69 00 68 0D 6A 0A FD D1
Scan Data Send Format	Code: 07 C6 04 08 00 EB 00 FE 3C Code+Suffix: 07 C6 04 08 00 EB 01 FE 3B Code+Suffix 2: 07 C6 04 08 00 EB 02 FE 3A Code+Suffix 1+Suffix 2: 07 C6 04 08 00 EB 03 FE 39 Prefix+Code: 07 C6 04 08 00 EB 04 FE 38 Prefix+Code+Suffix 1: 07 C6 04 08 00 EB 05 FE 37 Prefix+Code+Suffix 2: 07 C6 04 08 00 EB 06 FE 36 Prefix+Code+Suffix 1+Suffix 2: 07 C6 04 08 00 EB 07 FE 35
Baud rate	1200: 07 C6 04 08 00 9C 03 FE 88 2400: 07 C6 04 08 00 9C 04 FE 87 4800: 07 C6 04 08 00 9C 05 FE 86 9600: 07 C6 04 08 00 9C 06 FE 85 19200: 07 C6 04 08 00 9C 07 FE 84 38400: 07 C6 04 08 00 9C 08 FE 83 57600: 07 C6 04 08 00 9C 09 FE 82 115200: 07 C6 04 08 00 9C 0A FE 81
Parity	Odd number: 07 C6 04 08 00 9E 00 FE 89 Even number: 07 C6 04 08 00 9E 01 FE 88 Tag: 07 C6 04 08 00 9E 02 FE 87 Black space: 07 C6 04 08 00 9E 03 FE 86 None: 07 C6 04 08 00 9E 04 FE 85
Software Shake Hand	Allow: 07 C6 04 08 00 9F 01 FE 87

	Forbid: 07 C6 04 08 00 9F 00 FE 88
Decoded packet format	Send the original decoded data: 07 C6 04 08 00 EE 00 FE 39 Send the decoded data of data packet: 07 C6 04 08 00 EE 01 FE 38
Host serial response times out	0.1s: 07 C6 04 08 00 9B 01 FE 8B
Stop Bit	1 bit stop bit: 07 C6 04 08 00 9D 01 FE 89 2 bit stop bit: 07 C6 04 08 00 9D 02 FE 88
Intercharacter Delay	1s: 07 C6 04 08 00 6E 01 FE B8
Host Character Timeout	500ms: 07 C6 04 08 00 EF 32 FE 06 200ms: 07 C6 04 08 00 EF 14 FE 24 50ms: 07 C6 04 08 00 EF 05 FE 33
Communication Interface	Serial: 08 C6 04 08 00 F2 01 00 FE 33 USB KBW: 08 C6 04 08 00 F2 01 01 FE 32 USB Serial: 08 C6 04 08 00 F2 01 02 FE 31 HID POS: 08 C6 04 08 00 F2 01 0E FE 25
PS2 Mode	AUTO: 08 C6 04 08 00 F2 A6 00 FD 8E Single PS2: 08 C6 04 08 00 F2 A6 01 FD 8D
Lighting Control	The light turn on only when read : 08 C6 04 08 00 F2 02 00 FE 32 Always on : 08 C6 04 08 00 F2 02 01 FE 31 Always off : 08 C6 04 08 00 F2 02 02 FE 30
Collimation Control	The light turn on only when read : 08 C6 04 08 00 F2 03 00 FE 31 Always on : 08 C6 04 08 00 F2 03 01 FE

	30 Always off : 08 C6 04 08 00 F2 03 02 FE 2F
Collimation whether flashing	*Flashing: 08 C6 04 08 00 F2 B8 00 FD 7C Not Flashing: 08 C6 04 08 00 F2 B8 01 FD 7B
Sensitivity Rating	Super High Sensitivity:08 C6 04 08 00 F2 04 00 FE 30 High Sensitivity:08 C6 04 08 00 F2 04 01 FE 2F Medium Sensitivity:08 C6 04 08 00 F2 04 02 FE 2E Low Sensitivity:08 C6 04 08 00 F2 04 03 FE 2D
Custom Sensitivity	00:08 C6 04 08 00 F3 01 00 FE 32 01:08 C6 04 08 00 F3 01 01 FE 31 05:08 C6 04 08 00 F3 01 05 FE 2D 10:08 C6 04 08 00 F3 01 0A FE 28 15:08 C6 04 08 00 F3 01 0F FE 23
Stable Induction Time	500ms:08 C6 04 08 00 F3 02 05 FE 2C 1000ms:08 C6 04 08 00 F3 02 0A FE 27 300ms: 08 C6 04 08 00 F3 02 03 FE 2E
1D Backward Barcode Reading	Forbid: 08 C6 04 08 00 F2 91 00 FD A3 Allow: 08 C6 04 08 00 F2 91 01 FD A2
Output Character Set Type	Original: 08 C6 04 08 00 F2 06 00 FE 2E GBK:08 C6 04 08 00 F2 06 01 FE 2D UNICODE:08 C6 04 08 00 F2 06 02 FE 2C
Keyboard Settlement	America: 08 C6 04 08 00 F6 01 01 FE 2E Belgium: 08 C6 04 08 00 F6 01 02 FE

2D

Brazil (ABNT2) : 08 C6 04 08 00 F6 01
03 FE 2C

Denmark: 08 C6 04 08 00 F6 01 06 FE
29

Finland: 08 C6 04 08 00 F6 01 07 FE
28

France: 08 C6 04 08 00 F6 01 08 FE 27

Austria,Germany: 08 C6 04 08 00 F6 01
09 FE 26

Greek: 08 C6 04 08 00 F6 01 0A FE 25

Hungary: 08 C6 04 08 00 F6 01 0B FE
24

Italy: 08 C6 04 08 00 F6 01 0D FE 22

Netherlands: 08 C6 04 08 00 F6 01 0F
FE 20

Norway: 08 C6 04 08 00 F6 01 10 FE
1F

Poland: 08 C6 04 08 00 F6 01 11 FE 1E

Portugal : 08 C6 04 08 00 F6 01 12 FE
1D

Romania (Standard) : 08 C6 04 08 00
F6 01 13 FE 1C

Russia: 08 C6 04 08 00 F6 01 14 FE 1B

Slovakia: 08 C6 04 08 00 F6 01 15 FE
1A

Spain: 08 C6 04 08 00 F6 01 16 FE 19

Sweden: 08 C6 04 08 00 F6 01 17 FE
18

Turkey_F: 08 C6 04 08 00 F6 01 19 FE
16

Turkey_Q: 08 C6 04 08 00 F6 01 1A FE
15

UK: 08 C6 04 08 00 F6 01 1B FE 14

Japan: 08 C6 04 08 00 F6 01 1C FE 13

	<p>Czech: 08 C6 04 08 00 F6 01 1D FE 12</p> <p>Thailand Keyboard Kedmanee: 08 C6 04 08 00 F6 01 1E FE 11</p> <p>Ukraine: 08 C6 04 08 00 F6 01 1F FE 10</p> <p>Arabic Language_101: 08 C6 04 08 00 F6 01 20 FE 0F</p> <p>Croatia: 08 C6 04 08 00 F6 01 21 FE 0E</p> <p>Korea: 08 C6 04 08 00 F6 01 22 FE 0D</p> <p>Bulgaria: 08 C6 04 08 00 F6 01 23 FE 0C</p>
Keyboard Output Character Time Interval	<p>0ms: 08 C6 04 08 00 F3 04 00 FE 2F</p> <p>5ms: 08 C6 04 08 00 F3 04 01 FE 2E</p> <p>10ms: 08 C6 04 08 00 F3 04 02 FE 2D</p>
Keyboard Output Character Time Interval Quickly Set Up	<p>0ms: 08 C6 04 08 00 F2 B2 00 FD 82</p> <p>10ms: 08 C6 04 08 00 F2 B2 01 FD 81</p> <p>50ms: 08 C6 04 08 00 F2 B2 02 FD 80</p>
Keyboard Output Force Letter Case Conversion	<p>Keyboard case is not converted: 08 C6 04 08 00 F2 A1 00 FD 93</p> <p>All uppercase: 08 C6 04 08 00 F2 A1 01 FD 92</p> <p>All lowercase: 08 C6 04 08 00 F2 A1 02 FD 91</p> <p>Case reversal: 08 C6 04 08 00 F2 A1 03 FD 90</p>
Keyboard Type	<p>Standard Keyboard: 08 C6 04 08 00 F2 B4 00 FD 80</p> <p>Virtual Keyboard: 08 C6 04 08 00 F2 B4 01 FD 7F</p>
STX and ETX Setting	<p>Forbid: 08 C6 04 08 00 F2 B7 00 FD 7D</p> <p>STX(Prefix): 08 C6 04 08 00 F2 B7 01 FD 7C</p> <p>ETX(Suffix 1): 08 C6 04 08 00 F2 B7 02</p>

	<p>FD 7B</p> <p>STX(Prefix)+ETX(Suffix 1): 08 C6 04 08 00 F2 B7 03 FD 7A</p>
ASCII Control Character Output Mode Selection	<p>Output function keys:08 C6 04 08 00 F2 AD 00 FD 87</p> <p>Output Ctrl combination key:08 C6 04 08 00 F2 AD 01 FD 86</p> <p>ALT output control characters:08 C6 04 08 00 F2 AD 02 FD 85</p> <p>Output Enter、 DownArrow:08 C6 04 08 00 F2 AD 03 FD 84</p>
1D Code Global Enable Switch	<p>Forbid: 08 C6 04 08 00 F2 11 00 FE 23</p> <p>Allow: 08 C6 04 08 00 F2 11 01 FE 22</p>
2D Code Global Enable Switch	<p>Forbid: 08 C6 04 08 00 F2 50 00 FD E4</p> <p>Allow: 08 C6 04 08 00 F2 50 01 FD E3</p>
All Code Global Enable Switch	<p>Forbid: 08 C6 04 08 00 F2 90 00 FD A4</p> <p>Allow: 08 C6 04 08 00 F2 90 01 FD A3</p>
Hide Header Characters	<p>Forbid: 08 C6 04 08 00 F2 C6 00 FD 6E</p> <p>Allow: 08 C6 04 08 00 F2 C6 01 FD 6D</p>
Hide Middle Characters	<p>Forbid: 08 C6 04 08 00 F2 C7 00 FD 6D</p> <p>Allow: 08 C6 04 08 00 F2 C7 01 FD 6C</p>
Hide Tail Characters	<p>Forbid: 08 C6 04 08 00 F2 C8 00 FD 6C</p> <p>Allow: 08 C6 04 08 00 F2 C8 01 FD 6B</p>
Same Code Delay	<p>1500ms:08 C6 04 08 00 F3 03 0F FE 21</p> <p>500ms:08 C6 04 08 00 F3 03 05 FE 2B</p> <p>300ms: 08 C6 04 08 00 F3 03 03 FE 2D</p>
Same Code Delay Quickly Set Up	<p>No delay: 08 C6 04 08 00 F2 C9 00 FD 6B</p> <p>Delay 1s: 08 C6 04 08 00 F2 C9 01 FD 6A</p> <p>Delay 3s: 08 C6 04 08 00 F2 C9 03 FD 68</p> <p>Delay 5s: 08 C6 04 08 00 F2 C9 05 FD</p>

	66 Delay 7s: 08 C6 04 08 00 F2 C9 07 FD 64 Infinite delay (Forbid Same Code Read): 08 C6 04 08 00 F2 C9 09 FD 62
Set Multiple Prefixes in succession	SetMultiple Prefixes in succession: 08 C6 04 08 00 F3 10 00 FE 23
Set Multiple Suffixes in succession	Set Multiple Suffixes in succession: 08 C6 04 08 00 F3 11 00 FE 22
Finish Setting Multiple Prefixes Suffixes in succession	Finish Setting Multiple Prefixes Suffixes in succession: 08 C6 04 08 00 FF F6 00 FD 31
Setting Multiple Prefixes Suffixes Data Transfer Format	Data+Multiple Suffixes: 07 C6 04 08 00 EB 08 FE 34 Multiple Prefixes+Data: 07 C6 04 08 00 EB 09 FE 33 Multiple Prefixes+Data+Multiple Suffixes: 07 C6 04 08 00 EB 0A FE 32
Heartbeat Control	Forbid: 08 C6 04 08 00 F2 CD 00 FD 67 Heartbeat don't need ACK: 08 C6 04 08 00 F2 CD 01 FD 66 Heartbeat need ACK: 08 C6 04 08 00 F2 CD 02 FD 65
UPC-A	
Read	Forbid: 07 C6 04 08 00 01 00 FF 26 Allow: 07 C6 04 08 00 01 01 FF 25
Transmit UPC-A Check Character	Forbid: 07 C6 04 08 00 28 00 FE FF Allow: 07 C6 04 08 00 28 01 FE FE
Extra Code	None(00): 07 C6 04 08 00 10 00 FF 17 Allow (01) : 07 C6 04 08 00 10 01 FF 16 Automatic differentiation(02): 07 C6 04 08 00 10 02 FF 15
Leading Code	None(00): 07 C6 04 08 00 22 00 FF 05

	System identification (01) : 07 C6 04 08 00 22 01 FF 04 Country\System identification(02) : 07 C6 04 08 00 22 02 FF 03
UPC-A 2 Bit Extra Code	Allow: 08 C6 04 08 00 F2 40 01 FD F3 Forbid: 08 C6 04 08 00 F2 40 00 FD F4
UPC-A 5 Bit Extra Code	Allow: 08 C6 04 08 00 F2 41 01 FD F2 Forbid: 08 C6 04 08 00 F2 41 00 FD F3
UPC-A Extra Code Must be Identified	Allow: 08 C6 04 08 00 F2 42 01 FD F1 Forbid: 08 C6 04 08 00 F2 42 00 FD F2
UPC-E	
Read	Forbid: 07 C6 04 08 00 02 00 FF 25 Allow: 07 C6 04 08 00 02 01 FF 24
Transmit UPC-E Check bit	Forbid: 07 C6 04 08 00 29 00 FE FE Allow: 07 C6 04 08 00 29 01 FE FD
Extra Code	None(00): 07 C6 04 08 00 10 00 FF 17 Allow (01) : 07 C6 04 08 00 10 01 FF 16 Automatic differentiation(02): 07 C6 04 08 00 10 02 FF 15
Leading Code	None(00): 07 C6 04 08 00 23 00 FF 04 System identification (01) : 07 C6 04 08 00 23 01 FF 03 Country\System identification(02) : 07 C6 04 08 00 23 02 FF 02
UPC-E Turn UPC-A	Forbid: 07 C6 04 08 00 25 00 FF 02 Allow: 07 C6 04 08 00 25 01 FF 01
UPC-E 2 Bit Extra Code	Allow: 08 C6 04 08 00 F2 3D 01 FD F6 Forbid: 08 C6 04 08 00 F2 3D 00 FD F7
UPC-E 5 Bit Extra Code	Allow: 08 C6 04 08 00 F2 3E 01 FD F5 Forbid: 08 C6 04 08 00 F2 3E 00 FD F6
UPC-E Extra Code Must be Identified	Allow: 08 C6 04 08 00 F2 3F 01 FD F4

	Forbid: 08 C6 04 08 00 F2 3F 00 FD F5
UPC-E1	Forbid: 08 C6 04 08 00 F2 15 00 FE 1F Allow: 08 C6 04 08 00 F2 15 01 FE 1E
EAN-8	
Read	Forbid: 07 C6 04 08 00 04 00 FF 23 Allow: 07 C6 04 08 00 04 01 FF 22
Extra Code	None(00): 07 C6 04 08 00 10 00 FF 17 Allow (01) : 07 C6 04 08 00 10 01 FF 16
EAN-8 2 Bit Extra Code	Allow: 08 C6 04 08 00 F2 37 01 FD FC Forbid: 08 C6 04 08 00 F2 37 00 FD FD
EAN-8 5 Bit Extra Code	Allow: 08 C6 04 08 00 F2 38 01 FD FB Forbid: 08 C6 04 08 00 F2 38 00 FD FC
EAN-8 Extra Code Must be Identified	Allow: 08 C6 04 08 00 F2 39 01 FD FA Forbid: 08 C6 04 08 00 F2 39 00 FD FB
EAN-8 Send Check Bit	Forbid: 08 C6 04 08 00 F2 80 00 FD B4 Allow: 08 C6 04 08 00 F2 80 01 FD B3
EAN-13	
Read	Forbid: 07 C6 04 08 00 03 00 FF 24 Allow: 07 C6 04 08 00 03 01 FF 23
EAN-13 2 Bit Extra Code	Allow: 08 C6 04 08 00 F2 3A 01 FD F9 Forbid: 08 C6 04 08 00 F2 3A 00 FD FA
EAN-13 5 Bit Extra Code	Allow: 08 C6 04 08 00 F2 3B 01 FD F8 Forbid: 08 C6 04 08 00 F2 3B 00 FD F9
EAN-13 Extra Code Must be Identified	Allow: 08 C6 04 08 00 F2 3C 01 FD F7 Forbid: 08 C6 04 08 00 F2 3C 00 FD F8
EAN-13 Send Check Character	Forbid: 08 C6 04 08 00 F2 16 00 FE 1E Allow: 08 C6 04 08 00 F2 16 01 FE 1D
Extra Code	None(00): 07 C6 04 08 00 10 00 FF 17

	Allow (01) : 07 C6 04 08 00 10 01 FF 16
Bookland EAN(ISBN)	
Read	Forbid: 07 C6 04 08 00 53 00 FE D4 Allow: 07 C6 04 08 00 53 01 FE D3
Format	Output 10 Bit:08 C6 04 08 00 F1 40 00 FD F5 Output 13 Bit:08 C6 04 08 00 F1 40 01 FD F4
Code 128 Code system switch	Forbid: 07 C6 04 08 00 08 00 FF 1F Allow: 07 C6 04 08 00 08 01 FF 1E
Code 128 Length	One Single length: 06: 0B C6 04 08 00 F5 04 06 F5 05 00 FD 2A Two Single length: 04 and 06: 0B C6 04 08 00 F5 04 06 F5 05 04 FD 26 Within a certain length range: 04 to 09: 0B C6 04 08 00 F5 04 04 F5 05 09 FD 23 Any length range: 0B C6 04 08 00 F5 04 00 F5 05 00 FD 30
GS1-128 (UCC/EAN-128)	Forbid: 07 C6 04 08 00 0E 00 FF 19 Allow: 07 C6 04 08 00 0E 01 FF 18
UCC/EAN-128 Send Check Character	Allow: 08 C6 04 08 00 F2 36 01 FD FD Forbid: 08 C6 04 08 00 F2 36 00 FD FE
UCC/EAN-128 Length	One Single length: 06: 0B C6 04 08 00 F5 06 06 F5 07 00 FD 26 Two Single length: 04 and 06: 0B C6 04 08 00 F5 06 06 F5 07 04 FD 22 Within a certain length range:

	<p>04 to 09: 0B C6 04 08 00 F5 06 04 F5 07 09 FD 1F</p> <p>Any length range :</p> <p>0B C6 04 08 00 F5 06 00 F5 07 00 FD 2C</p>
ISBT 128	<p>Forbid: 07 C6 04 08 00 54 00 FE D3</p> <p>Allow: 07 C6 04 08 00 54 01 FE D2</p>
Code 39	<p>Forbid: 07 C6 04 08 00 00 00 FF 27</p> <p>Allow: 07 C6 04 08 00 00 01 FF 26</p>
Code 39 Length	<p>One Single length:</p> <p>Length 06:</p> <p>09 C6 04 08 00 12 06 13 00 FE FA</p> <p>Length 16:</p> <p>09 C6 04 08 00 12 10 13 00 FE F0</p> <p>Length14:</p> <p>09 C6 04 08 00 12 0E 13 00 FE F2</p> <p>Two Single length:</p> <p>02 and 04:</p> <p>09 C6 04 08 00 12 04 13 02 FE FA</p> <p>16 and 14:</p> <p>09 C6 04 08 00 12 10 13 0E FE E2</p> <p>Within a certain length range:</p> <p>02 to 09:</p> <p>09 C-6 04 08 00 12 02 13 09 FE F5</p> <p>0x02 to 0x37(55)Default:</p> <p>09 C6 04 08 00 12 02 13 37 FE C7</p> <p>14 to 15:</p> <p>09 C6 04 08 00 12 0E 13 0F FE E3</p> <p>15 to 16:</p> <p>09 C6 04 08 00 12 0F 13 10 FE E1</p> <p>Any length range: 09 C6 04 08 00 12 00 13 00 FE F0</p>
Code 39	<p>Forbid: 07 C6 04 08 00 30 00 FE F7</p>

Check Bit Verification	Allow: 07 C6 04 08 00 30 01 FE F6
Send Code 39 Check Bit	Forbid: 07 C6 04 08 00 2B 00 FE FC Allow: 07 C6 04 08 00 2B 01 FE FB
Code 39 Full ASCII	07 C6 04 08 00 11 01 FF 15
Code 39 Transmit Start Character and Stop Character	Forbid: 08 C6 04 08 00 F2 30 00 FE 04 Allow: 08 C6 04 08 00 F2 30 01 FE 03
Convert Code 39 to Code 32 (Italian medical code)	Forbid: 07 C6 04 08 00 56 00 FE D1 Allow: 07 C6 04 08 00 56 01 FE D0
Code 32 Prefixes	Forbid: 07 C6 04 08 00 E7 00 FE 40 Allow: 07 C6 04 08 00 E7 01 FE 3F
Code 93	Forbid: 07 C6 04 08 00 09 00 FF 1E Allow: 07 C6 04 08 00 09 01 FF 1D
Code 93 Length	One Single length: 04: 09 C6 04 08 00 1A 04 1B 00 FE EC Two Single length: 04 and 06: 09 C6 04 08 00 1A 06 1B 04 FE E6 Within a certain length range: 04 to 09: 09 C6 04 08 00 1A 04 1B 09 FE E3 Any length range : 09 C6 04 08 00 1A 00 1B 00 FE F0
Code 11	Forbid: 07 C6 04 08 00 0A 00 FF 1D Allow: 07 C6 04 08 00 0A 01 FF 1C
Set Code 11 Length	One Single length: 06: 09 C6 04 08 00 1C 06 1D 00 FE E6 Two Single length: 04 and 06: 09 C6 04 08 00 1C 06 1D 04 FE E2 Within a certain length range: 04 to 09: 09 C6 04 08 00 1C 04 1D

	<p>09 FE DF</p> <p>Any length range : 09 C6 04 08 00 1C 00 1D 00 FE EC</p>
Code 11 Check Bit Verification	<p>None: 07 C6 04 08 00 34 00 FE F3</p> <p>1 Bit: 07 C6 04 08 00 34 01 FE F2</p> <p>2 Bit: 07 C6 04 08 00 34 02 FE F1</p>
Send Code 11 Check Bit	<p>Forbid: 07 C6 04 08 00 2F 00 FE F8</p> <p>Allow: 07 C6 04 08 00 2F 01 FE F7</p>
Interleaved 2 of 5/ITF/ Corss 25 Code	<p>Forbid: 07 C6 04 08 00 06 00 FF 21</p> <p>Allow: 07 C6 04 08 00 06 01 FF 20</p>
Set Interleaved 2 of 5 Length	<p>One Single length:</p> <p>06: 09 C6 04 08 00 16 06 17 00 FE F2</p> <p>Two Single length:</p> <p>04 and 06: 09 C6 04 08 00 16 06 17 04 FE EE</p> <p>Within a certain length range:</p> <p>04 to 09: 09 C6 04 08 00 16 04 17 09 FE EB</p> <p>Any length range: 09 C6 04 08 00 16 00 17 00 FE F8</p>
Interleaved 2 of 5 Check Bit Verification	<p>Forbid: 07 C6 04 08 00 31 00 FE F6</p> <p>Allow: 07 C6 04 08 00 31 01 FE F5</p>
Send Interleaved 2 of 5 Check Bit	<p>Forbid: 07 C6 04 08 00 2C 00 FE FB</p> <p>Allow: 07 C6 04 08 00 2C 01 FE FA</p>
Industrial 2 of 5	<p>Forbid: 07 C6 04 08 00 05 00 FF 22</p> <p>Allow: 07 C6 04 08 00 05 01 FF 21</p>
Set Industrial 2 of 5 Length	<p>One Single length:</p> <p>06: 09 C6 04 08 00 14 06 15 00 FE F6</p> <p>Two Single length:</p> <p>04 和 06: 09 C6 04 08 00 14 06 15 04 FE F2</p>

	<p>Within a certain length range:</p> <p>04 到 09: 09 C6 04 08 00 14 04 15 09 FE EF</p> <p>Any length range: 09 C6 04 08 00 14 00 15 00 FE FC</p>
Matrix 25 matrix 25	<p>Forbid: 08 C6 04 08 00 F2 20 00 FE 14</p> <p>Allow: 08 C6 04 08 00 F2 20 01 FE 13</p>
Matrix 25 Check Bit Verification	<p>Forbid: 08 C6 04 08 00 F2 21 00 FE 13</p> <p>Allow: 08 C6 04 08 00 F2 21 01 FE 12</p>
Transfer Matrix 25 Check Character	<p>Forbid: 08 C6 04 08 00 F2 22 00 FE 12</p> <p>Allow: 08 C6 04 08 00 F2 22 01 FE 11</p>
Matrix 25 Length	<p>One Single length:</p> <p>06: 0B C6 04 08 00 F5 00 06 F5 01 00 FD 32</p> <p>Two Single length:</p> <p>04 and 06: 0B C6 04 08 00 F5 00 06 F5 01 04 FD 2E</p> <p>Within a certain length range:</p> <p>04 to 09: 0B C6 04 08 00 F5 00 04 F5 01 09 FD 2B</p> <p>Any length range :</p> <p>0B C6 04 08 00 F5 00 00 F5 01 00 FD 38</p>
Standard 25 / IATA 25/Standard 25	<p>Forbid: 08 C6 04 08 00 F2 23 00 FE 11</p> <p>Allow: 08 C6 04 08 00 F2 23 01 FE 10</p>
Standard 25 Length	<p>One Single length:</p> <p>06: 09 C6 04 08 00 F5 02 06 F5 03 00 FD 2E</p> <p>Two Single length:</p> <p>04 and 06: 09 C6 04 08 00 F5 02 06 F5 03 04 FD 2A</p> <p>Within a certain length range:</p> <p>04 to 09: 09 C6 04 08 00 F5 02 04</p>

	<p>F5 03 09 FD 27</p> <p>Any length range : 09 C6 04 08 00 F5 02 00 F5 03 00 FD 34</p>
Codabar	<p>Forbid: 07 C6 04 08 00 07 00 FF 20</p> <p>Allow: 07 C6 04 08 00 07 01 FF 1F</p>
Set Codabar Length	<p>One Single length:</p> <p>04: 09 C6 04 08 00 18 04 19 00 FE F0</p> <p>Two Single length:</p> <p>09 C6 04 08 00 18 05 19 04 FE EB</p> <p>Within a certain length range:</p> <p>04 to 09: 09 C6 04 08 00 18 04 19 09 FE E7</p> <p>Any length range : 09 C6 04 08 00 18 00 19 00 FE F4</p>
Codabar Check	<p>Allow: 08 C6 04 08 00 F2 4C 01 FD E7</p> <p>Forbid: 08 C6 04 08 00 F2 4C 00 FD E8</p>
Codabar Send Check Character	<p>Allow: 08 C6 04 08 00 F2 4D 01 FD E6</p> <p>Forbid: 08 C6 04 08 00 F2 4D 00 FD E7</p>
NOTIS Transmission Format	<p>Forbid: 07 C6 04 08 00 37 00 FE F0</p> <p>Allow: 07 C6 04 08 00 37 01 FE EF</p>
Start Character and End Character Formats	<p>ABCD/ABCD: 08 C6 04 08 00 F2 31 00 FE 03</p> <p>ABCD/TN*E: 08 C6 04 08 00 F2 31 01 FE 02</p>
Set the upper and lower case of the start and end characters	<p>Upper Case: 08 C6 04 08 00 F2 32 00 FE 02</p> <p>Lower Case: 08 C6 04 08 00 F2 32 01 FE 01</p>
MSI /MSI PLESSEY	<p>Forbid: 07 C6 04 08 00 0B 00 FF 1C</p> <p>Allow: 07 C6 04 08 00 0B 01 FF 1B</p>
Set MSI Length	<p>One Single length:</p> <p>04: 09 C6 04 08 00 1E 04 1F 00 FE E4</p>

	<p>Two Single length:</p> <p>04 and 05: 09 C6 04 08 00 1E 05 1F 04 FE DF</p> <p>Within a certain length range:</p> <p>02 to 09: 09 C6 04 08 00 1E 02 1F 09 FE DD</p> <p>Any length range : 09 C6 04 08 00 1E 00 1F 00 FE E8</p>
MSI Check Bit	<p>1 Bit: 07 C6 04 08 00 32 00 FE F5</p> <p>2 Bit: 07 C6 04 08 00 32 01 FE F4</p>
Send MSI Check Bit	<p>Forbid: 07 C6 04 08 00 2E 00 FE F9</p> <p>Allow: 07 C6 04 08 00 2E 01 FE F8</p>
GS1 DataBar(RSS) 14	<p>Forbid: 08 C6 04 08 00 F0 52 00 FD E4</p> <p>Allow: 08 C6 04 08 00 F0 52 01 FD E3</p>
PDF417	<p>Allow: 07 C6 04 08 00 0F 01 FF 17</p> <p>Forbid: 07 C6 04 08 00 0F 00 FF 18</p>
QRCode	<p>Allow: 08 C6 04 08 00 F0 25 01 FE 10</p> <p>Forbid: 08 C6 04 08 00 F0 25 00 FE 11</p>
QR Forward and Backward Reading	<p>Only read Forward: 08 C6 04 08 00 F2 67 00 FD CD</p> <p>Only read Backward: 08 C6 04 08 00 F2 67 01 FD CC</p> <p>Forward and Backward both can read: 08 C6 04 08 00 F2 67 02 FD CB</p>
MicroQRCode	<p>Allow: 08 C6 04 08 00 F1 3D 01 FD F7</p> <p>Forbid: 08 C6 04 08 00 F1 3D 00 FD F8</p>
DataMatrix	<p>Allow: 08 C6 04 08 00 F0 24 01 FE 11</p> <p>Forbid: 08 C6 04 08 00 F0 24 00 FE 12</p>
Forward and Backward Reading	<p>Only read Forward: 08 C6 04 08 00 F2 6B 00 FD C9</p> <p>Only read Backward: 08 C6 04 08 00 F2 6B 01 FD C8</p> <p>Forward and Backward both can read: 08 C6 04 08 00 F2 6B 02 FD C7</p>

MaxiCode	Forbid: 08 C6 04 08 00 F0 26 00 FE 10 Allow: 08 C6 04 08 00 F0 26 01 FE 0F
Aztec	Forbid: 08 C6 04 08 00 F0 28 00 FE 0E Allow: 08 C6 04 08 00 F0 28 01 FE 0D
Han Xin Code	Forbid: 08 C6 04 08 00 F0 2F 00 FE 07 Allow: 08 C6 04 08 00 F0 2F 01 FE 06
GS1 COMPOSITE COD	Forbid: 08 C6 04 08 00 F2 17 00 FE 1D Allow: 08 C6 04 08 00 F2 17 01 FE 1C