

Wavespectrum Laser, Inc.

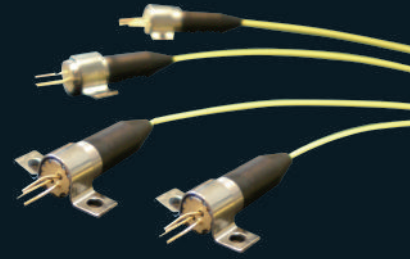

Catalog

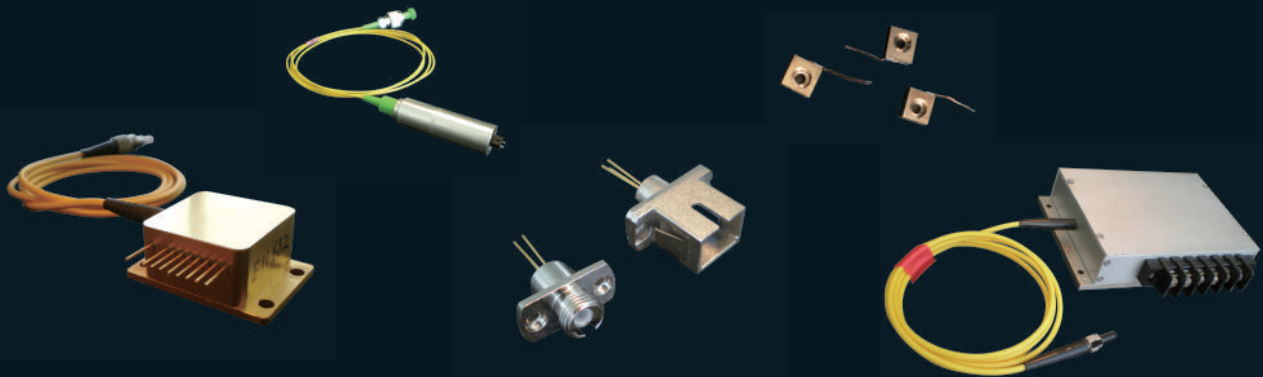



CONTENTS

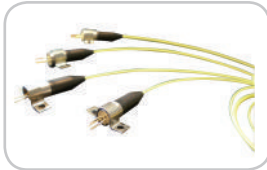

Single Mode Fiber Coupled Laser Diode/1th Page

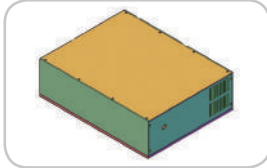

405nm High Power Fiber Coupled Laser System/8th Page



Single Mode TO Package Laser Diode/9th Page



High Power Multimode Laser Diode/11th Page



Single Mode Fiber Coupled Laser System/14th Page



Multimode Fiber Coupled Laser Diode/20th Page



Dual(Tri)-wavelength Fiber Coupled Laser Diode/27th Page



3-Channel Fiber Coupled Laser System/28th Page

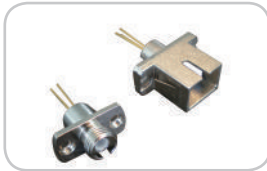

Coaxial & Receptacle Package Photodiodes/29th Page

Single Mode Fiber Coupled Laser Diode

- 375nm~1610nm
- SM and PM Fiber
- Coaxial Package
- 1mW~200mW
- High Coupling Efficiency
- Long Lifetime
- High Stability
- Customized Wavelength
- Customized Output Power

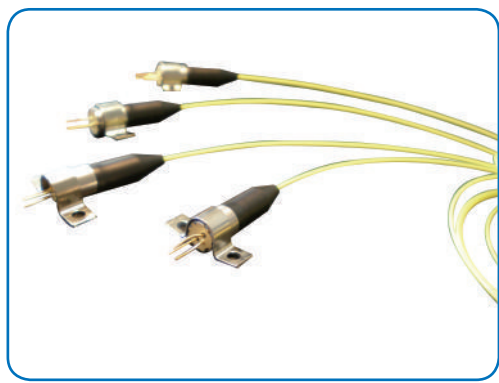

Wavelength	Part Number	Output Power	Fiber Type	Fiber Core	Package	Connector
375nm	WSLP-375-004m-4-PD	4mW	UV SM	3um	Coaxial	FC
	WSLP-375-040m-4	40mW	UV SM	3um	Coaxial	FC
	WSLP-375-004m-PM-PD	4mW	UV PM	3um	Coaxial	FC
	WSLP-375-040m-PM	40mW	UV PM	3um	Coaxial	FC
	WSLP-375-XXXm	Customized	Customized	Customized	Coaxial	FC

Wavelength	Part Number	Output Power	Fiber Type	Fiber Core	Package	Connector
405nm	WSLP-405-015m-4	15mW	UV SM	3um	Coaxial	FC
	WSLP-405-050m-4	50mW	UV SM	3um	Coaxial	FC
	WSLP-405-015m-PM	15mW	UV PM	3um	Coaxial	FC
	WSLP-405-050m-PM	50mW	UV PM	3um	Coaxial	FC
	WSLP-405-XXXm	Customized	Customized	Customized	Coaxial	FC

Wavelength	Part Number	Output Power	Fiber Type	Fiber Core	Package	Connector
445nm	WSLP-445-015m-4	15mW	UV SM	3um	Coaxial	FC
	WSLP-445-030m-4	30mW	UV SM	3um	Coaxial	FC
	WSLP-445-015m-PM	15mW	UV PM	3um	Coaxial	FC
	WSLP-445-030m-PM	30mW	UV PM	3um	Coaxial	FC
	WSLP-445-XXXm	Customized	Customized	Customized	Coaxial	FC

Wavelength	Part Number	Output Power	Fiber Type	Fiber Core	Package	Connector
473nm	WSLP-473-004m-4-PD	4mW	UV SM	3um	Coaxial	FC
	WSLP-473-004m-PM-PD	4mW	UV PM	3um	Coaxial	FC
	WSLP-473-XXXm	Customized	Customized	Customized	Coaxial	FC



Wavelength	Part Number	Output Power	Fiber Type	Fiber Core	Package	Connector
488nm	WSLP-488-012m-4-PD	12mW	UV SM	3um	Coaxial	FC
	WSLP-488-012m-PM-PD	12mW	UV PM	3um	Coaxial	FC
	WSLP-488-XXXm	Customized	Customized	Customized	Coaxial	FC

Wavelength	Part Number	Output Power	Fiber Type	Fiber Core	Package	Connector
635nm	WSLP-635-005m-4-PD	5mW	SM	4um	Coaxial	FC
	WSLP-635-005m-PM-PD	5mW	PM	4um	Coaxial	FC
	WSLP-635-040m-4	40mW	SM	4um	Coaxial	FC
	WSLP-635-040m-PM	40mW	PM	4um	Coaxial	FC
	WSLP-635-XXXm	Customized	Customized	Customized	Coaxial	FC

Wavelength	Part Number	Output Power	Fiber Type	Fiber Core	Package	Connector
650nm	WSLP-650-002m-9-PD	2mW	SM	9um	Coaxial	FC
	WSLP-650-030m-4	30mW	SM	4um	Coaxial	FC
	WSLP-650-030m-PM	30mW	PM	4um	Coaxial	FC
	WSLP-650-050m-4	50mW	SM	4um	Coaxial	FC
	WSLP-650-050m-PM	50mW	PM	4um	Coaxial	FC
	WSLP-650-XXXm	Customized	Customized	Customized	Coaxial	FC

Wavelength	Part Number	Output Power	Fiber Type	Fiber Core	Package	Connector
670nm	WSLP-670-001m-4-PD	1mW	SM	4um	Coaxial	FC
	WSLP-670-001m-PM-PD	1mW	PM	4um	Coaxial	FC
	WSLP-670-005m-4-PD	5mW	SM	4um	Coaxial	FC
	WSLP-670-005m-PM-PD	5mW	PM	4um	Coaxial	FC
	WSLP-670-XXXm	Customized	Customized	Customized	Coaxial	FC

Wavelength	Part Number	Output Power	Fiber Type	Fiber Core	Package	Connector
685nm	WSLP-685-015m-4-PD	15mW	SM	4um	Coaxial	FC
	WSLP-685-015m-PM-PD	15mW	PM	4um	Coaxial	FC
	WSLP-685-025m-4-PD	25mW	SM	4um	Coaxial	FC
	WSLP-685-025m-PM-PD	25mW	PM	4um	Coaxial	FC
	WSLP-685-XXXm	Customized	Customized	Customized	Coaxial	FC

Wavelength	Part Number	Output Power	Fiber Type	Fiber Core	Package	Connector
690nm	WSLP-690-010m-4-PD	10mW	SM	4um	Coaxial	FC
	WSLP-690-010m-PM-PD	10mW	PM	4um	Coaxial	FC
	WSLP-690-XXXm	Customized	Customized	Customized	Coaxial	FC

Leading Supplier of Fiber Coupled Diode Laser

Wavelength	Part Number	Output Power	Fiber Type	Fiber Core	Package	Connector
705nm	WSLP-705-012m-4-PD	12mW	SM	4um	Coaxial	FC
	WSLP-705-012m-PM-PD	12mW	PM	4um	Coaxial	FC
	WSLP-705-XXXm	Customized	Customized	Customized	Coaxial	FC

Wavelength	Part Number	Output Power	Fiber Type	Fiber Core	Package	Connector
730nm	WSLP-730-002m-4-PD	2mW	SM	4um	Coaxial	FC
	WSLP-730-002m-PM-PD	2mW	PM	4um	Coaxial	FC
	WSLP-730-012m-4-PD	12mW	SM	4um	Coaxial	FC
	WSLP-730-012m-PM-PD	12mW	PM	4um	Coaxial	FC
	WSLP-730-XXXm	Customized	Customized	Customized	Coaxial	FC

Wavelength	Part Number	Output Power	Fiber Type	Fiber Core	Package	Connector
760nm	WSLP-760-002m-4-PD	2mW	SM	4um	Coaxial	FC
	WSLP-760-002m-PM-PD	2mW	PM	4um	Coaxial	FC
	WSLP-760-XXXm	Customized	Customized	Customized	Coaxial	FC

Wavelength	Part Number	Output Power	Fiber Type	Fiber Core	Package	Connector
785nm	WSLP-785-030m-4-PD	30mW	SM	4um	Coaxial	FC
	WSLP-785-030m-PM-PD	30mW	PM	4um	Coaxial	FC
	WSLP-785-050m-4	50mW	SM	4um	Coaxial	FC
	WSLP-785-045m-PM	45mW	PM	4um	Coaxial	FC
	WSLP-785-XXXm	Customized	Customized	Customized	Coaxial	FC

Wavelength	Part Number	Output Power	Fiber Type	Fiber Core	Package	Connector
795nm	WSLP-795-045m-4-PD	45mW	SM	4um	Coaxial	FC
	WSLP-795-045m-PM-PD	45mW	PM	4um	Coaxial	FC
	WSLP-795-XXXm	Customized	Customized	Customized	Coaxial	FC





Wavelength	Part Number	Output Power	Fiber Type	Fiber Core	Package	Connector
808nm	WSLP-808-015m-4	15mW	SM	5um	Coaxial	FC
	WSLP-808-015m-PM	15mW	PM	5um	Coaxial	FC
	WSLP-808-040m-4	40mW	SM	5um	Coaxial	FC
	WSLP-808-040m-PM	40mW	PM	5um	Coaxial	FC
	WSLP-808-090m-4-PD	90mW	SM	5um	Coaxial	FC
	WSLP-808-090m-PM-PD	90mW	PM	5um	Coaxial	FC
	WSLP-808-XXXm	Customized	Customized	Customized	Coaxial	FC

Wavelength	Part Number	Output Power	Fiber Type	Fiber Core	Package	Connector
830nm	WSLP-830-015m-4-PD	15mW	SM	5um	Coaxial	FC
	WSLP-830-010m-PM-PD	10mW	PM	5um	Coaxial	FC
	WSLP-830-025m-4	25mW	SM	5um	Coaxial	FC
	WSLP-830-025m-PM	25mW	PM	5um	Coaxial	FC
	WSLP-830-090m-4-PD	90mW	SM	5um	Coaxial	FC
	WSLP-830-090m-PM-PD	90mW	PM	5um	Coaxial	FC
	WSLP-830-XXXm	Customized	Customized	Customized	Coaxial	FC

Wavelength	Part Number	Output Power	Fiber Type	Fiber Core	Package	Connector
850nm	WSLP-850-002m-9-PD	2mW	SM	9um	Coaxial	FC
	WSLP-850-015m-4-PD	15mW	SM	5um	Coaxial	FC
	WSLP-850-010m-PM-PD	10mW	PM	5um	Coaxial	FC
	WSLP-850-090m-4-PD	90mW	SM	5um	Coaxial	FC
	WSLP-850-090m-PM-PD	90mW	PM	5um	Coaxial	FC
	WSLP-850-XXXm	Customized	Customized	Customized	Coaxial	FC

Wavelength	Part Number	Output Power	Fiber Type	Fiber Core	Package	Connector
880nm	WSLP-880-002m-9-PD	2mW	SM	9um	Coaxial	FC
	WSLP-880-002m-4-PD	2mW	SM	6um	Coaxial	FC
	WSLP-880-001m-PM-PD	1mW	PM	6um	Coaxial	FC
	WSLP-880-XXXm	Customized	Customized	Customized	Coaxial	FC

Wavelength	Part Number	Output Power	Fiber Type	Fiber Core	Package	Connector
905nm	WSLP-905-020m-4-PD	20mW	SM	6um	Coaxial	FC
	WSLP-905-020m-PM-PD	20mW	PM	6um	Coaxial	FC
	WSLP-905-050m-4-PD	50mW	SM	6um	Coaxial	FC
	WSLP-905-050m-PM-PD	50mW	PM	6um	Coaxial	FC
	WSLP-905-XXXm	Customized	Customized	Customized	Coaxial	FC

Wavelength	Part Number	Output Power	Fiber Type	Fiber Core	Package	Connector
915nm	WSLP-915-050m-4-PD	50mW	SM	6um	Coaxial	FC
	WSLP-915-050m-PM-PD	50mW	PM	6um	Coaxial	FC
	WSLP-915-180m-4-PD	180mW	SM	6um	Coaxial	FC
	WSLP-915-180m-PM-PD	180mW	PM	6um	Coaxial	FC
	WSLP-915-XXXm	Customized	Customized	Customized	Coaxial	FC

Wavelength	Part Number	Output Power	Fiber Type	Fiber Core	Package	Connector
940nm	WSLP-940-020m-4-PD	20mW	SM	6um	Coaxial	FC
	WSLP-940-020m-PM-PD	20mW	PM	6um	Coaxial	FC
	WSLP-940-050m-4-PD	50mW	SM	6um	Coaxial	FC
	WSLP-940-050m-PM-PD	50mW	PM	6um	Coaxial	FC
	WSLP-940-180m-4-PD	180mW	SM	6um	Coaxial	FC
	WSLP-940-180m-PM-PD	180mW	PM	6um	Coaxial	FC
	WSLP-940-XXXm	Customized	Customized	Customized	Coaxial	FC

Wavelength	Part Number	Output Power	Fiber Type	Fiber Core	Package	Connector
980nm	WSLP-980-005m-9-PD	5mW	SM	9um	Coaxial	FC
	WSLP-980-090m-4-PD	90mW	SM	6um	Coaxial	FC
	WSLP-980-090m-PM-PD	90mW	PM	6um	Coaxial	FC
	WSLP-980-180m-4-PD	180mW	SM	6um	Coaxial	FC
	WSLP-980-180m-PM-PD	180mW	PM	6um	Coaxial	FC
	WSLP-980-XXXm	Customized	Customized	Customized	Coaxial	FC

Wavelength	Part Number	Output Power	Fiber Type	Fiber Core	Package	Connector
1060nm	WSLP-1060-020m-4-PD	20mW	SM	6um	Coaxial	FC
	WSLP-1060-020m-PM-PD	20mW	PM	6um	Coaxial	FC
	WSLP-1060-050m-4-PD	50mW	SM	6um	Coaxial	FC
	WSLP-1060-050m-PM-PD	50mW	PM	6um	Coaxial	FC
	WSLP-1060-180m-4-PD	180mW	SM	6um	Coaxial	FC
	WSLP-1060-180m-PM-PD	180mW	PM	6um	Coaxial	FC
	WSLP-1060-XXXm	Customized	Customized	Customized	Coaxial	FC

Wavelength	Part Number	Output Power	Fiber Type	Fiber Core	Package	LD Type
1270nm	WSLP-1270-002m-9-DFB	2mW	SM	9um	Coaxial	DFB
	WSLP-1270-002m-PM-DFB	2mW	PM	9um	Coaxial	DFB

Wavelength	Part Number	Output Power	Fiber Type	Fiber Core	Package	LD Type
1290nm	WSLP-1290-002m-9-DFB	2mW	SM	9um	Coaxial	DFB
	WSLP-1290-002m-PM-DFB	2mW	PM	9um	Coaxial	DFB



Wavelength	Part Number	Output Power	Fiber Type	Fiber Core	Package	LD Type
1310nm	WSLP-1310-004m-9-DFB	4mW	SM	9um	Coaxial	DFB
	WSLP-1310-010m-PM-DFB	10mW	PM	9um	Coaxial	DFB
	WSLP-1310-010m-9-DFB	10mW	SM	9um	Coaxial	DFB
	WSLP-1310-002m-9-FP	2mW	SM	9um	Coaxial	FP
	WSLP-1310-XXXm	Customized	Customized	Customized	Coaxial	FP/DFB

Wavelength	Part Number	Output Power	Fiber Type	Fiber Core	Package	LD Type
1330nm	WSLP-1330-002m-9-DFB	2mW	SM	9um	Coaxial	DFB
	WSLP-1330-002m-PM-DFB	2mW	PM	9um	Coaxial	DFB

Wavelength	Part Number	Output Power	Fiber Type	Fiber Core	Package	LD Type
1350nm	WSLP-1350-002m-9-DFB	2mW	SM	9um	Coaxial	DFB
	WSLP-1350-002m-PM-DFB	2mW	PM	9um	Coaxial	DFB

Wavelength	Part Number	Output Power	Fiber Type	Fiber Core	Package	LD Type
1370nm	WSLP-1370-002m-9-DFB	2mW	SM	9um	Coaxial	DFB
	WSLP-1370-002m-PM-DFB	2mW	PM	9um	Coaxial	DFB

Wavelength	Part Number	Output Power	Fiber Type	Fiber Core	Package	LD Type
1390nm	WSLP-1390-002m-9-DFB	2mW	SM	9um	Coaxial	DFB
	WSLP-1390-002m-PM-DFB	2mW	PM	9um	Coaxial	DFB

Wavelength	Part Number	Output Power	Fiber Type	Fiber Core	Package	LD Type
1410nm	WSLP-1410-002m-9-DFB	2mW	SM	9um	Coaxial	DFB
	WSLP-1410-002m-PM-DFB	2mW	PM	9um	Coaxial	DFB

Wavelength	Part Number	Output Power	Fiber Type	Fiber Core	Package	LD Type
1430nm	WSLP-1430-002m-9-DFB	2mW	SM	9um	Coaxial	DFB
	WSLP-1430-002m-PM-DFB	2mW	PM	9um	Coaxial	DFB

Wavelength	Part Number	Output Power	Fiber Type	Fiber Core	Package	LD Type
1450nm	WSLP-1450-002m-9-DFB	2mW	SM	9um	Coaxial	DFB
	WSLP-1450-002m-PM-DFB	2mW	PM	9um	Coaxial	DFB

Wavelength	Part Number	Output Power	Fiber Type	Fiber Core	Package	LD Type
1470nm	WSLP-1470-002m-9-DFB	2mW	SM	9um	Coaxial	DFB
	WSLP-1470-002m-PM-DFB	2mW	PM	9um	Coaxial	DFB

Wavelength	Part Number	Output Power	Fiber Type	Fiber Core	Package	LD Type
1490nm	WSLP-1490-002m-9-DFB	2mW	SM	9um	Coaxial	DFB
	WSLP-1490-002m-PM-DFB	2mW	PM	9um	Coaxial	DFB

Wavelength	Part Number	Output Power	Fiber Type	Fiber Core	Package	LD Type
1510nm	WSLP-1510-002m-9-DFB	2mW	SM	9um	Coaxial	DFB
	WSLP-1510-002m-PM-DFB	2mW	PM	9um	Coaxial	DFB

Wavelength	Part Number	Output Power	Fiber Type	Fiber Core	Package	LD Type
1530nm	WSLP-1530-002m-9-DFB	2mW	SM	9um	Coaxial	DFB
	WSLP-1530-002m-PM-DFB	2mW	PM	9um	Coaxial	DFB

Wavelength	Part Number	Output Power	Fiber Type	Fiber Core	Package	LD Type
1550nm	WSLP-1550-003m-9-DFB	3mW	SM	9um	Coaxial	DFB
	WSLP-1550-008m-9-DFB	8mW	SM	9um	Coaxial	DFB
	WSLP-1550-010m-9-DFB	10mW	SM	9um	Coaxial	DFB
	WSLP-1550-010m-PM-DFB	10mW	PM	9um	Coaxial	DFB
	WSLP-1550-002m-9-FP	2mW	SM	9um	Coaxial	FP
	WSLP-1550-XXXm	Customized	Customized	Customized	Coaxial	FP/DFB

Wavelength	Part Number	Output Power	Fiber Type	Fiber Core	Package	LD Type
1570nm	WSLP-1570-002m-9-DFB	2mW	SM	9um	Coaxial	DFB
	WSLP-1570-002m-PM-DFB	2mW	PM	9um	Coaxial	DFB

Wavelength	Part Number	Output Power	Fiber Type	Fiber Core	Package	LD Type
1590nm	WSLP-1590-002m-9-DFB	2mW	SM	9um	Coaxial	DFB
	WSLP-1590-002m-PM-DFB	2mW	PM	9um	Coaxial	DFB

Wavelength	Part Number	Output Power	Fiber Type	Fiber Core	Package	LD Type
1610nm	WSLP-1610-002m-9-DFB	2mW	SM	9um	Coaxial	DFB
	WSLP-1610-002m-PM-DFB	2mW	PM	9um	Coaxial	DFB

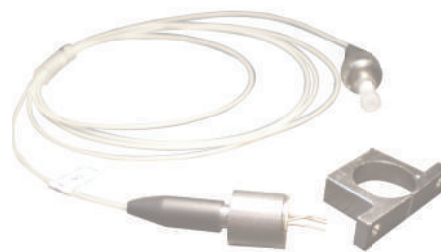

405nm High Power Fiber Coupled Laser System

- 405nm
- 60mW~10W Power
- Turnkey Laser System
- Built-in TEC Cooling
- 10k Hours Long Lifetime
- External Modulation
- Customized Output Power

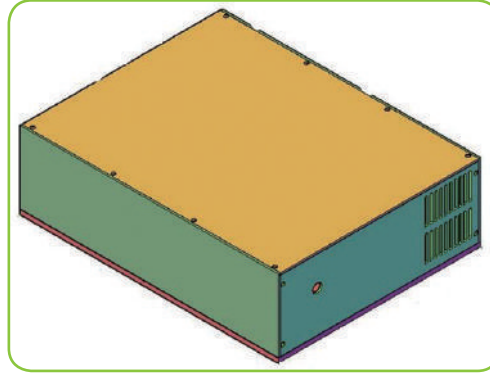

Part Number	Wavelength	Output Power	Fiber Core	Laser Type	Cooling
WSLS-405-060m	405nm	60mW	50um,60um 105um,200um	Turnkey System	TEC
WSLS-405-140m	405nm	140mW	50um,60um 105um,200um	Turnkey System	TEC
WSLS-405-220m	405nm	220mW	50um,60um, 105um,200um	Turnkey System	TEC
WSLS-405-450m	405nm	450mW	200um,400um	Turnkey System	TEC
WSLS-405-800m	405nm	800mW	400um,600um	Turnkey System	TEC
WSLS-405-001	405nm	1W	400um,600um	Turnkey System	TEC
WSLS-405-002	405nm	2W	600um,800um	Turnkey System	TEC
WSLS-405-005	405nm	5W	800um,1000um	Turnkey System	TEC
WSLS-405-010	405nm	10W	1200um,1500um	Turnkey System	TEC
WSLS-405-XXX	405nm	Customized	Customized	Turnkey System	TEC

445nm 635nm 650nm 785nm 793nm 808nm 830nm 880nm 940nm 980nm 1060nm Optional



Single Mode TO Package Laser Diode

- 405nm~1550nm
- Single Mode Laser Diode
- TO18 Package
- 20mW~100mW
- Long Lifetime
- High Stability

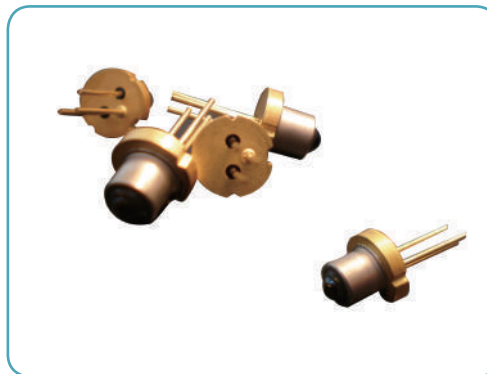

Wavelength	Part Number	Output Power	Mode Type	Laser Type	Photodiodes	Package
405nm	WSLD-405-020m-1-PD	20mW	SM	FP	Yes	5.6mm
	WSLD-405-020m-1	20mW	SM	FP	No	5.6mm
	WSLD-405-060m-1	60mW	SM	FP	No	5.6mm
	WSLD-405-100m-1	100mW	SM	FP	No	5.6mm

Wavelength	Part Number	Output Power	Mode Type	Laser Type	Photodiodes	Package
635nm	WSLD-635-030m-1-PD	30mW	SM	FP	Yes	5.6mm

Wavelength	Part Number	Output Power	Mode Type	Laser Type	Photodiodes	Package
658nm	WSLD-650-080m-1	80mW	SM	FP	No	5.6mm
	WSLD-650-150m-1	150mW	SM	FP	No	5.6mm

Wavelength	Part Number	Output Power	Mode Type	Laser Type	Photodiodes	Package
670nm	WSLD-670-005m-1-PD	5mW	SM	FP	Yes	5.6mm

Wavelength	Part Number	Output Power	Mode Type	Laser Type	Photodiodes	Package
785nm	WSLD-785-090m-1-PD	90mW	SM	FP	Yes	5.6mm
	WSLD-785-150m-1	150mW	SM	FP	Optional	5.6mm





Wavelength	Part Number	Output Power	Mode Type	Laser Type	Photodiodes	Package
808nm	WSLD-808-050m-1	50mW	SM	FP	Optional	5.6mm
	WSLD-808-100m-1	100mW	SM	FP	Optional	5.6mm

Wavelength	Part Number	Output Power	Mode Type	Laser Type	Photodiodes	Package
830nm	WSLD-830-030m-1-PD	30mW	SM	FP	Yes	5.6mm
	WSLD-830-100m-1	100mW	SM	FP	Optional	5.6mm

Wavelength	Part Number	Output Power	Mode Type	Laser Type	Photodiodes	Package
850nm	WSLD-850-050m-1-PD	50mW	SM	FP	Yes	5.6mm
	WSLD-850-100m-1-PD	100mW	SM	FP	Yes	5.6mm

Wavelength	Part Number	Output Power	Mode Type	Laser Type	Photodiodes	Package
870nm	WSLD-870-010m-1-PD	10mW	SM	FP	Yes	5.6mm

Wavelength	Part Number	Output Power	Mode Type	Laser Type	Photodiodes	Package
980nm	WSLD-980-050m-1-PD	50mW	SM	FP	Yes	5.6mm

Wavelength	Part Number	Output Power	Mode Type	Laser Type	Photodiodes	Package
1310nm	WSLD-1310-020m-1-PD	20mW	SM	DFB	Yes	5.6mm

Wavelength	Part Number	Output Power	Mode Type	Laser Type	Photodiodes	Package
1550nm	WSLD-1550-020m-1-PD	20mW	SM	DFB	Yes	5.6mm

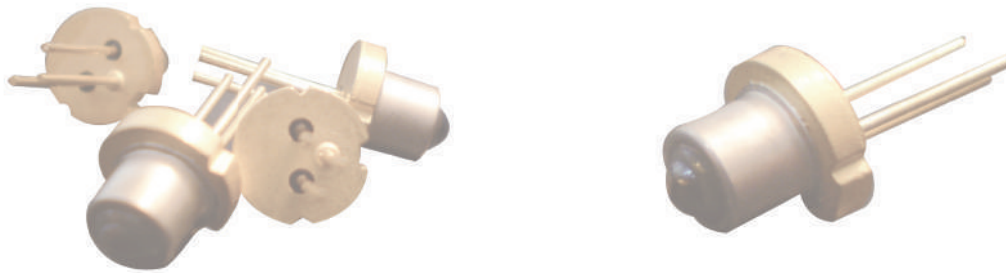



High Power Multimode Laser Diode

- 405nm~1550nm
- Multimode Laser Diode
- TO18,TO5,TO3,C-mount Package
- 50mW~10W
- Long Lifetime
- High Stability



Wavelength	Part Number	Output Power	Mode Type	Photodiodes	Package
405nm	WSLD-405-200m-1	200mW	MM	No	5.6mm
	WSLD-405-500m-1	500mW	MM	No	5.6mm

Wavelength	Part Number	Output Power	Mode Type	Photodiodes	Package
445nm	WSLD-445-500m-1	500mW	MM	No	5.6mm
	WSLD-445-001-1	1W	MM	No	5.6mm

Wavelength	Part Number	Output Power	Mode Type	Photodiodes	Package
635nm	WSLD-635-300m-1	300mW	MM	No	5.6mm
	WSLD-635-500m-C	500mW	MM	No	C-mount or TO3
	WSLD-635-001-C	1W	MM	No	C-mount or TO3

Wavelength	Part Number	Output Power	Mode Type	Photodiodes	Package
650nm	WSLD-650-500m-C	500mW	MM	No	C-mount or TO3
	WSLD-650-001-C	1W	MM	No	C-mount or TO3

Wavelength	Part Number	Output Power	Mode Type	Photodiodes	Package
785nm	WSLD-785-001-C	1W	MM	No	C-mount or TO3
	WSLD-785-1500m-C	1.5W	MM	No	C-mount or TO3





Wavelength	Part Number	Output Power	Mode Type	Photodiodes	Package
793nm	WSLD-793-003-C	3W	MM	No	C-mount
	WSLD-793-003-3	3W	MM	No	TO3

Wavelength	Part Number	Output Power	Mode Type	Photodiodes	Package
808nm	WSLD-808-200m-1-PD	200mW	MM	Yes	5.6mm
	WSLD-808-300m-1-PD	300mW	MM	Yes	5.6mm
	WSLD-808-500m-2-PD	500mW	MM	Yes	9mm
	WSLD-808-001-2-PD	1W	MM	Optional	9mm
	WSLD-808-002-C	2W	MM	No	C-mount or TO3
	WSLD-808-003-C	3W	MM	No	C-mount or TO3
	WSLD-808-005-C	5W	MM	No	C-mount or TO3
	WSLD-808-006-C	6W	MM	No	C-mount or TO3
	WSLD-808-008-C	8W	MM	No	C-mount or TO3
	WSLD-808-010-C	10W	MM	No	C-mount or TO3

Wavelength	Part Number	Output Power	Mode Type	Photodiodes	Package
830nm	WSLD-830-100m-1-PD	100mW	MM	Yes	5.6mm
	WSLD-830-001-2-PD	1W	MM	Optional	9mm
	WSLD-830-001-C	1W	MM	No	C-mount or TO3
	WSLD-830-002-C	2W	MM	No	C-mount or TO3
	WSLD-830-003-C	3W	MM	No	C-mount or TO3

Wavelength	Part Number	Output Power	Mode Type	Photodiodes	Package
850nm	WSLD-850-300m-1-PD	300mW	MM	Yes	5.6mm
	WSLD-850-500m-2-PD	500mW	MM	Yes	9mm

Wavelength	Part Number	Output Power	Mode Type	Photodiodes	Package
880nm	WSLD-880-003-C	3W	MM	No	C-mount or TO3
	WSLD-880-003-3	3W	MM	No	C-mount or TO3

Wavelength	Part Number	Output Power	Mode Type	Photodiodes	Package
940nm	WSLD-940-001-2-PD	1W	MM	Optional	9mm
	WSLD-940-002-C	2W	MM	No	C-mount or TO3
	WSLD-940-003-C	3W	MM	No	C-mount or TO3
	WSLD-940-005-C	5W	MM	No	C-mount or TO3
	WSLD-940-010-C	10W	MM	No	C-mount or TO3

Wavelength	Part Number	Output Power	Mode Type	Photodiodes	Package
980nm	WSLD-980-200m-1-PD	200mW	MM	Yes	5.6mm
	WSLD-980-250m-2-PD	250mW	MM	Yes	9mm
	WSLD-980-500m-2-PD	500mW	MM	Yes	9mm
	WSLD-980-001-2-PD	1W	MM	Optional	9mm
	WSLD-980-002-C	2W	MM	No	C-mount or TO3
	WSLD-980-003-C	3W	MM	No	C-mount or TO3
	WSLD-980-005-C	5W	MM	No	C-mount or TO3
	WSLD-980-010-C	10W	MM	No	C-mount or TO3

Wavelength	Part Number	Output Power	Mode Type	Photodiodes	Package
1064nm	WSLD-1064-002-C	2W	MM	No	C-mount or TO3
	WSLD-1064-003-C	3W	MM	No	C-mount or TO3

Wavelength	Part Number	Output Power	Mode Type	Photodiodes	Package
1450nm	WSLD-1450-500m-C	500mW	MM	No	C-mount
	WSLD-1450-500m-3	500mW	MM	No	TO3

Wavelength	Part Number	Output Power	Mode Type	Photodiodes	Package
1470nm	WSLD-1470-001-C	1W	MM	No	C-mount
	WSLD-1470-001-3	1W	MM	No	TO3

Wavelength	Part Number	Output Power	Mode Type	Photodiodes	Package
1550nm	WSLD-1550-001-C	1W	MM	No	C-mount
	WSLD-1550-001-3	1W	MM	No	TO3

Single Mode Fiber Coupled Laser System

- 375nm~1610nm
- Turnkey Laser System
- With SM or PM Fiber
- 1mW~200mW
- High Stability
- Built-in TEC Cooling
- External Modulation
- Customized Wavelength
- Customized Output Power



Wavelength	Part Number	Output Power	Fiber Type	Fiber Core	Laser Type
375nm	WSLS-375-040m-4	0~40mW Adjustable	UV SM	3um	Turnkey System
	WSLS-375-040m-PM	0~40mW Adjustable	UV PM	3um	Turnkey System
	WSLS-375-XXXm	Customized	Customized	Customized	Turnkey System

Wavelength	Part Number	Output Power	Fiber Type	Fiber Core	Laser Type
405nm	WSLS-405-015m-4	0~15mW Adjustable	UV SM	3um	Turnkey System
	WSLS-405-015m-PM	0~15mW Adjustable	UV PM	3um	Turnkey System
	WSLS-405-050m-4	0~50mW Adjustable	UV SM	3um	Turnkey System
	WSLS-405-050m-PM	0~50mW Adjustable	UV PM	3um	Turnkey System
	WSLS-405-XXXm	Customized	Customized	Customized	Turnkey System

Wavelength	Part Number	Output Power	Fiber Type	Fiber Core	Laser Type
445nm	WSLS-445-025m-4	0~25mW Adjustable	UV SM	3um	Turnkey System
	WSLS-445-025m-PM	0~25mW Adjustable	UV PM	3um	Turnkey System
	WSLS-445-XXXm	Customized	Customized	Customized	Turnkey System

Wavelength	Part Number	Output Power	Fiber Type	Fiber Core	Laser Type
488nm	WSLS-488-012m-4	0~12mW Adjustable	UV SM	3um	Turnkey System
	WSLS-488-012m-PM	0~12mW Adjustable	UV PM	3um	Turnkey System
	WSLS-488-XXXm	Customized	Customized	Customized	Turnkey System

Wavelength	Part Number	Output Power	Fiber Type	Fiber Core	Laser Type
532nm	WSLS-532-010m-4	0~10mW Adjustable	SM	4um	Turnkey System
	WSLS-532-010m-PM	0~10mW Adjustable	PM	4um	Turnkey System
	WSLS-532-020m-4	0~20mW Adjustable	SM	4um	Turnkey System
	WSLS-532-020m-PM	0~20mW Adjustable	PM	4um	Turnkey System
	WSLS-532-XXXm	Customized	Customized	Customized	Turnkey System

Wavelength	Part Number	Output Power	Fiber Type	Fiber Core	Laser Type
635nm	WSLS-635-005m-4	0~5mW Adjustable	SM	4um	Turnkey System
	WSLS-635-005m-PM	0~5mW Adjustable	PM	4um	Turnkey System
	WSLS-635-040m-4	0~40mW Adjustable	SM	4um	Turnkey System
	WSLS-635-040m-PM	0~40mW Adjustable	PM	4um	Turnkey System
	WSLS-635-XXXm	Customized	Customized	Customized	Turnkey System

Wavelength	Part Number	Output Power	Fiber Type	Fiber Core	Laser Type
650nm	WSLS-650-020m-4	0~20mW Adjustable	SM	4um	Turnkey System
	WSLS-650-020m-PM	0~20mW Adjustable	PM	4um	Turnkey System
	WSLS-650-050m-4	0~50mW Adjustable	SM	4um	Turnkey System
	WSLS-650-050m-PM	0~50mW Adjustable	PM	4um	Turnkey System
	WSLS-650-XXXm	Customized	Customized	Customized	Turnkey System

Wavelength	Part Number	Output Power	Fiber Type	Fiber Core	Laser Type
670nm	WSLS-670-002m-4	0~2mW Adjustable	SM	4um	Turnkey System
	WSLS-670-002m-PM	0~2mW Adjustable	PM	4um	Turnkey System
	WSLS-670-005m-4	0~5mW Adjustable	SM	4um	Turnkey System
	WSLS-670-005m-PM	0~5mW Adjustable	PM	4um	Turnkey System
	WSLS-670-XXXm	Customized	Customized	Customized	Turnkey System

Wavelength	Part Number	Output Power	Fiber Type	Fiber Core	Laser Type
685nm	WSLS-685-015m-4	0~15mW Adjustable	SM	4um	Turnkey System
	WSLS-685-015m-PM	0~15mW Adjustable	PM	4um	Turnkey System
	WSLS-685-025m-4	0~25mW Adjustable	SM	4um	Turnkey System
	WSLS-685-025m-PM	0~25mW Adjustable	PM	4um	Turnkey System
	WSLS-685-XXXm	Customized	Customized	Customized	Turnkey System



Wavelength	Part Number	Output Power	Fiber Type	Fiber Core	Laser Type
690nm	WSLS-690-010m-4	0~10mW Adjustable	SM	4um	Turnkey System
	WSLS-690-010m-PM	0~10mW Adjustable	PM	4um	Turnkey System
	WSLS-690-XXXm	Customized	Customized	Customized	Turnkey System

Wavelength	Part Number	Output Power	Fiber Type	Fiber Core	Laser Type
705nm	WSLS-705-010m-4	0~10mW Adjustable	SM	4um	Turnkey System
	WSLS-705-010m-PM	0~10mW Adjustable	PM	4um	Turnkey System
	WSLS-705-020m-4	0~20mW Adjustable	SM	4um	Turnkey System
	WSLS-705-020m-PM	0~20mW Adjustable	PM	4um	Turnkey System
	WSLS-705-XXXm	Customized	Customized	Customized	Turnkey System

Wavelength	Part Number	Output Power	Fiber Type	Fiber Core	Laser Type
730nm	WSLS-730-010m-4	0~10mW Adjustable	SM	4um	Turnkey System
	WSLS-730-010m-PM	0~10mW Adjustable	PM	4um	Turnkey System
	WSLS-730-020m-4	0~20mW Adjustable	SM	4um	Turnkey System
	WSLS-730-020m-PM	0~20mW Adjustable	PM	4um	Turnkey System
	WSLS-730-XXXm	Customized	Customized	Customized	Turnkey System

Wavelength	Part Number	Output Power	Fiber Type	Fiber Core	Laser Type
760nm	WSLS-760-002m-4	0~2mW Adjustable	SM	4um	Turnkey System
	WSLS-760-002m-PM	0~2mW Adjustable	PM	4um	Turnkey System
	WSLS-760-XXXm	Customized	Customized	Customized	Turnkey System

Wavelength	Part Number	Output Power	Fiber Type	Fiber Core	Laser Type
785nm	WSLS-785-020m-4	0~20mW Adjustable	SM	4um	Turnkey System
	WSLS-785-020m-PM	0~20mW Adjustable	PM	4um	Turnkey System
	WSLS-785-040m-4	0~40mW Adjustable	SM	4um	Turnkey System
	WSLS-785-040m-PM	0~40mW Adjustable	PM	4um	Turnkey System
	WSLS-785-XXXm	Customized	Customized	Customized	Turnkey System

Leading Supplier of Fiber Coupled Diode Laser

Wavelength	Part Number	Output Power	Fiber Type	Fiber Core	Laser Type
795nm	WSLS-795-040m-4	0~40mW Adjustable	SM	4um	Turnkey System
	WSLS-795-040m-PM	0~40mW Adjustable	PM	4um	Turnkey System
	WSLS-795-XXXm	Customized	Customized	Customized	Turnkey System

Wavelength	Part Number	Output Power	Fiber Type	Fiber Core	Laser Type
808nm	WSLS-808-015m-4	0~15mW Adjustable	SM	5um	Turnkey System
	WSLS-808-010m-PM	0~10mW Adjustable	PM	5um	Turnkey System
	WSLS-808-080m-4	0~80mW Adjustable	SM	5um	Turnkey System
	WSLS-808-080m-PM	0~80mW Adjustable	PM	5um	Turnkey System
	WSLS-808-XXXm	Customized	Customized	Customized	Turnkey System

Wavelength	Part Number	Output Power	Fiber Type	Fiber Core	Laser Type
830nm	WSLS-830-015m-4	0~15mW Adjustable	SM	5um	Turnkey System
	WSLS-830-010m-PM	0~10mW Adjustable	PM	5um	Turnkey System
	WSLS-830-080m-4	0~80mW Adjustable	SM	5um	Turnkey System
	WSLS-830-080m-PM	0~80mW Adjustable	PM	5um	Turnkey System
	WSLS-830-XXXm	Customized	Customized	Customized	Turnkey System

Wavelength	Part Number	Output Power	Fiber Type	Fiber Core	Laser Type
850nm	WSLS-850-015m-4	0~15mW Adjustable	SM	5um	Turnkey System
	WSLS-850-010m-PM	0~10mW Adjustable	PM	5um	Turnkey System
	WSLS-850-080m-4	0~80mW Adjustable	SM	5um	Turnkey System
	WSLS-850-080m-PM	0~80mW Adjustable	PM	5um	Turnkey System
	WSLS-850-XXXm	Customized	Customized	Customized	Turnkey System

Wavelength	Part Number	Output Power	Fiber Type	Fiber Core	Laser Type
880nm	WSLS-880-002m-4	0~2mW Adjustable	SM	5um	Turnkey System
	WSLS-880-002m-PM	0~2mW Adjustable	PM	5um	Turnkey System
	WSLS-880-XXXm	Customized	Customized	Customized	Turnkey System

Single Mode Fiber Coupled Laser Diodes

405nm High Power Fiber Coupled Laser System

Single Mode TO Package Laser Diodes

Multimode High Power Laser Diodes

Single Mode Fiber Coupled Laser System

Multimode Fiber Coupled Laser Diodes

Dual(Tri)-Wavelength Fiber Coupled Laser Diodes

3-Channel Fiber Coupled Laser System

Coaxial & Receptacle Package Photodiodes



Wavelength	Part Number	Output Power	Fiber Type	Fiber Core	Laser Type
905nm	WSLS-905-020m-4	0~20mW Adjustable	SM	6um	Turnkey System
	WSLS-905-020m-PM	0~20mW Adjustable	PM	6um	Turnkey System
	WSLS-905-050m-4	0~50mW Adjustable	SM	6um	Turnkey System
	WSLS-905-050m-PM	0~50mW Adjustable	PM	6um	Turnkey System
	WSLS-905-XXXm	Customized	Customized	Customized	Turnkey System

Wavelength	Part Number	Output Power	Fiber Type	Fiber Core	Laser Type
915nm	WSLS-915-050m-4	0~50mW Adjustable	SM	6um	Turnkey System
	WSLS-915-050m-PM	0~50mW Adjustable	PM	6um	Turnkey System
	WSLS-915-180m-4	0~180mW Adjustable	SM	6um	Turnkey System
	WSLS-915-180m-PM	0~180mW Adjustable	PM	6um	Turnkey System
	WSLS-915-XXXm	Customized	Customized	Customized	Turnkey System

Wavelength	Part Number	Output Power	Fiber Type	Fiber Core	Laser Type
940nm	WSLS-940-020m-4	0~20mW Adjustable	SM	6um	Turnkey System
	WSLS-940-020m-PM	0~20mW Adjustable	PM	6um	Turnkey System
	WSLS-940-050m-4	0~50mW Adjustable	SM	6um	Turnkey System
	WSLS-940-050m-PM	0~50mW Adjustable	PM	6um	Turnkey System
	WSLS-940-180m-4	0~180mW Adjustable	SM	6um	Turnkey System
	WSLS-940-180m-PM	0~180mW Adjustable	PM	6um	Turnkey System
WSLS-940-XXXm	Customized	Customized	Customized	Turnkey System	

Wavelength	Part Number	Output Power	Fiber Type	Fiber Core	Laser Type
980nm	WSLS-980-090m-4	0~90mW Adjustable	SM	6um	Turnkey System
	WSLS-980-090m-PM	0~90mW Adjustable	PM	6um	Turnkey System
	WSLS-980-180m-4	0~180mW Adjustable	SM	6um	Turnkey System
	WSLS-980-180m-PM	0~180mW Adjustable	PM	6um	Turnkey System
	WSLS-980-XXXm	Customized	Customized	Customized	Turnkey System

Wavelength	Part Number	Output Power	Fiber Type	Fiber Core	Laser Type
1060nm	WSLS-1060-020m-4	0~20mW Adjustable	SM	6um	Turnkey System
	WSLS-1060-020m-PM	0~20mW Adjustable	PM	6um	Turnkey System
	WSLS-1060-050m-4	0~50mW Adjustable	SM	6um	Turnkey System
	WSLS-1060-050m-PM	0~50mW Adjustable	PM	6um	Turnkey System
	WSLS-1060-180m-4	0~180mW Adjustable	SM	6um	Turnkey System
	WSLS-1060-180m-PM	0~180mW Adjustable	PM	6um	Turnkey System
	WSLS-1060-XXXm	Customized	Customized	Customized	Turnkey System

Wavelength	Part Number	Output Power	Fiber Type	Fiber Core	Laser Type
1310nm	WSLS-1310-010m-9-DFB	0~10mW Adjustable	SM	9um	System
	WSLS-1310-010m-PM-DFB	0~10mW Adjustable	PM	9um	System
	WSLS-1310-XXXm	Customized	Customized	Customized	System

Wavelength	Part Number	Output Power	Fiber Type	Fiber Core	Laser Type
1550nm	WSLS-1550-010m-9-DFB	0~10mW Adjustable	SM	9um	System
	WSLS-1550-010m-PM-DFB	0~10mW Adjustable	PM	9um	System
	WSLS-1550-XXXm	Customized	Customized	Customized	System

Wavelength	Part Number	Output Power	Fiber Type	Fiber Core	Laser Type
1270nm~1610nm	WSLS-1270-002m-9-DFB	0~2mW Adjustable	SM	9um	System
	WSLS-1270-002m-PM-DFB	0~2mW Adjustable	PM	9um	System
	WSLS-1270-XXXm	Customized	Customized	Customized	System
1270nm 1290nm 1310nm 1330nm 1350nm 1370nm 1390nm 1410nm 1430nm 1450nm 1470nm 1490nm 1510nm 1530nm 1550nm 1570nm 1590nm 1610nm Optional					

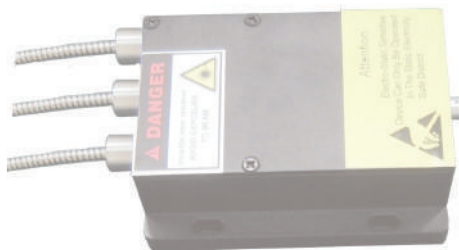

Single Mode Fiber Coupled Laser Diodes

405nm High Power Fiber Coupled Laser System

Single Mode TO Package Laser Diodes

Multimode High Power Laser Diodes

Single Mode Fiber Coupled Laser System

Multimode Fiber Coupled Laser Diodes

Dual(Tri)-Wavelength Fiber Coupled Laser Diodes

3-Channel Fiber Coupled Laser System

Coaxial & Receptacle Package Photodiodes



Multimode Fiber Coupled Laser Diode

- 405nm~1550nm
- With Multimode Fiber
- 2-pin,4-pin,9-pin,P2 Package
- 50mW~30W
- High Coupling Efficiency
- Long Lifetime
- Aiming Beam for IR Laser
- Receptacle Package Optional



Wavelength	Part Number	Output Power	Fiber Core	Package	Connector
405nm	WSLP-405-060m-M	60mW	50um/60um/105um	Coaxial	FC
	WSLP-405-140m-M	140mW	50um/60um/105um	Coaxial	FC
	WSLP-405-220m-M	220mW	50um/60um/105um	Coaxial	FC
	WSLP-405-450m-M	450mW	105um/200um	Coaxial	FC
	WSLB-405-001-H	1W	400um	HHL	FC
	WSLB-405-002-H	2W	400um	HHL	FC
	WSLB-405-005-H	5W	1200um	HHL	FC
	WSLB-405-010-H	10W	1500um	HHL	FC
	WSLB-405-XXX-H	Customized	Customized	HHL	FC

Wavelength	Part Number	Output Power	Fiber Core	Package	Connector
445nm	WSLP-445-500m-M	500mW	50um/60um/105um	Coaxial	FC
	WSLB-445-001-H	1W	400um	HHL	FC
	WSLB-445-002-H	2W	600um	HHL	FC
	WSLB-445-005-H	5W	800um	HHL	FC
	WSLB-445-010-H	10W	1500um	HHL	FC
	WSLB-445-XXX-H	Customized	Customized	HHL	FC



Leading Supplier of Fiber Coupled Diode Laser

Wavelength	Part Number	Output Power	Fiber Core	Package	Connector
635nm	WSLP-635-005m-M-PD	5mW	62.5um/105um	Coaxial	FC
	WSLX-635-350m-H	350mW	105um	4-pin/9-pin	FC
	WSLX-635-700m-H	700mW	105um	4-pin/9-pin	FC
	WSLB-635-001-H	1W	200um	P2	FC
	WSLB-635-002-H	2W	200um/400um	P2	FC
	WSLB-635-003-H	3W	400um/600um	P2	FC
	WSLB-635-005-H	5W	400um/600um	P2	FC
	WSLB-635-XXX-H	Customized	Customized	HHL	FC

Wavelength	Part Number	Output Power	Fiber Core	Package	Connector
650nm	WSLP-650-002m-M-PD	2mW	62.5um/105um	Coaxial	FC
	WSLP-650-030m-M	30mW	62.5um/105um	Coaxial	FC
	WSLP-650-070m-M	70mW	62.5um/105um	Coaxial	FC
	WSLX-650-350m-H	350mW	105um	4-pin/9-pin	FC
	WSLX-650-700m-H	700mW	105um	4-pin/9-pin	FC
	WSLB-650-001-H	1W	200um	P2	FC
	WSLB-650-002-H	2W	200um/400um	P2	FC
	WSLB-650-003-H	3W	400um/600um	P2	FC
	WSLB-650-005-H	5W	400um/600um	P2	FC
	WSLB-650-XXX-H	Customized	Customized	HHL	FC

Wavelength	Part Number	Output Power	Fiber Core	Package	Connector
670nm	WSLP-670-002m-M-PD	2mW	62.5um/105um	Coaxial	FC
	WSLP-670-005m-M-PD	5mW	62.5um/105um	Coaxial	FC
	WSLP-670-XXXm-M	Customized	Customized	Coaxial	FC

Wavelength	Part Number	Output Power	Fiber Core	Package	Connector
690nm	WSLP-690-015m-M-PD	15mW	62.5um/105um	Coaxial	FC
	WSLP-690-XXXm-M	Customized	Customized	Coaxial	FC

Single Mode Fiber Coupled Laser Diodes

405nm High Power Fiber Coupled Laser System

Single Mode TO Package Laser Diodes

Multimode High Power Laser Diodes

Single Mode Fiber Coupled Laser System

Multimode Fiber Coupled Laser Diodes

Dual/Tri-Wavelength Fiber Coupled Laser Diodes

3-Channel Fiber Coupled Laser System

Coaxial & Receptacle Package Photodiodes



Wavelength	Part Number	Output Power	Fiber Core	Package	Connector
705nm	WSLP-705-025m-M-PD	25mW	62.5um/105um	Coaxial	FC
	WSLP-705-XXXm-M	Customized	Customized	Coaxial	FC

Wavelength	Part Number	Output Power	Fiber Core	Package	Connector
730nm	WSLP-730-025m-M-PD	25mW	62.5um/105um	Coaxial	FC
	WSLP-730-XXXm-M	Customized	Customized	Coaxial	FC

Wavelength	Part Number	Output Power	Fiber Core	Package	Connector
785nm	WSLP-785-040m-M-PD	40mW	105um	Coaxial	FC
	WSLP-785-100m-M	100mW	105um	Coaxial	FC
	WSLP-785-700m-M	700mW	105um	Coaxial	FC
	WSLX-785-700m-H	700mW	105um	4-pin	FC
	WSLX-785-001-H	1W	105um	4-pin	FC
	WSLB-785-002-H	2W	200um	P2	FC
	WSLB-785-003-H	3W	200um	P2	FC
	WSLB-785-006-H	6W	400um	P2	FC
	WSLB-785-XXXm-H	Customized	Customized	HHL	FC

Wavelength	Part Number	Output Power	Fiber Core	Package	Connector
793nm	WSLX-793-002-H	2W	105um	4-pin	FC
	WSLB-793-006-H	6W	200um	P2	FC
	WSLB-793-010-H	10W	400um	P2	FC
	WSLB-793-030-H	30W	600um	P2	FC
	WSLB-793-XXX-H	Customized	Customized	HHL	FC

Wavelength	Part Number	Output Power	Fiber Core	Package	Connector
808nm	WSLP-808-080m-M-PD	80mW	105um	Coaxial	FC
	WSLP-808-200m-M-PD	200mW	105um	Coaxial	FC
	WSLP-808-001-M	1.5W	105um	Coaxial	FC
	WSLP-808-002-M	2W	105um	Coaxial	FC
	WSLP-808-003-M	3W	105um	Coaxial	FC
	WSLX-808-001-H	1.5W	105um	2-pin,4-pin	FC
	WSLX-808-002-H	2W	105um	2-pin,4-pin	FC

Wavelength	Part Number	Output Power	Fiber Core	Package	Connector
808nm	WSLX-808-003-H	3.5W	105um	4-pin,9-pin	FC
	WSLX-808-004-H	4W	200um	4-pin,9-pin	FC
	WSLX-808-005-H	5W	200um	4-pin,9-pin	FC
	WSLB-808-010-H	10W	400um	P2	FC
	WSLB-808-012-H	12W	400um	P2	FC
	WSLB-808-015-H	15W	400um	P2	FC
	WSLB-808-XXX-H	Customized	Customized	HHL	FC

Wavelength	Part Number	Output Power	Fiber Core	Package	Connector
830nm	WSLP-830-010m-M-PD	10mW	105um	Coaxial	FC
	WSLP-830-900m-M	900mW	105um	Coaxial	FC
	WSLX-830-001-H	1W	50um,62.5um	2-pin,4-pin	FC
	WSLX-830-1500m-H	1.5W	50um,62.5um	2-pin,4-pin	FC
	WSLX-830-002-H	2W	105um,200um	4-pin	FC
	WSLB-830-010-H	10W	400um	P2	FC
	WSLB-830-012-H	12W	400um	P2	FC
	WSLB-830-015-H	15W	400um	P2	FC
	WSLB-830-XXX-H	Customized	Customized	HHL	FC

Wavelength	Part Number	Output Power	Fiber Core	Package	Connector
850nm	WSLP-850-030m-M-PD	30mW	62.5um,105um	Coaxial	FC
	WSLP-850-800m-M	800mW	105um	Coaxial	FC
	WSLX-850-700m-H	700mW	50um,62.5um	4-pin	FC
	WSLX-850-1500m-H	1.5W	105um	4-pin	FC
	WSLB-850-010-H	10W	400um	P2	FC
	WSLB-850-015-H	15W	600um	P2	FC
	WSLB-850-XXX-H	Customized	Customized	HHL	FC

Wavelength	Part Number	Output Power	Fiber Core	Package	Connector
880nm	WSLP-880-005m-M-PD	5mW	105um	Coaxial	FC
	WSLP-880-002-M	2W	200um	Coaxial	FC
	WSLX-880-002-H	2W	105um,200um	4-pin	FC



Wavelength	Part Number	Output Power	Fiber Core	Package	Connector
880nm	WSLB-880-010-H	10W	400um	P2	FC
	WSLB-880-012-H	12W	400um	P2	FC
	WSLB-880-015-H	15W	400um	P2	FC
	WSLB-880-XXX-H	Customized	Customized	HHL	FC

Wavelength	Part Number	Output Power	Fiber Core	Package	Connector
905nm	WSLP-905-050m-M-PD	50mW	105um	Coaxial	FC
	WSLP-905-XXX-M	Customized	Customized	Coaxial	FC

Wavelength	Part Number	Output Power	Fiber Core	Package	Connector
940nm	WSLP-940-001-M	1.5W	105um	Coaxial	FC
	WSLP-940-002-M	2W	105um	Coaxial	FC
	WSLP-940-003-M	3W	105um	Coaxial	FC
	WSLX-940-002-H	2W	105um	2-pin,4-pin	FC
	WSLX-940-003-H	3.5W	105um	4-pin,9-pin	FC
	WSLX-940-004-H	4W	200um	4-pin,9-pin	FC
	WSLX-940-005-H	5W	200um	4-pin,9-pin	FC
	WSLB-940-010-H	10W	400um	P2	FC
	WSLB-940-012-H	12W	400um	P2	FC
	WSLB-940-015-H	15W	400um	P2	FC
WSLB-940-XXX-H	Customized	Customized	HHL	FC	

Wavelength	Part Number	Output Power	Fiber Core	Package	Connector
980nm	WSLP-980-100m-M-PD	100mW	62.5um,105um	Coaxial	FC
	WSLP-980-001-M	1.5W	105um	Coaxial	FC
	WSLP-980-002-M	2W	105um	Coaxial	FC
	WSLX-980-001-H	1.5W	105um	2-pin,4-pin	FC
	WSLX-980-002-H	2W	105um	2-pin,4-pin	FC
	WSLX-980-003-H	3W	200um	4-pin,9-pin	FC
	WSLX-980-004-H	4W	200um	4-pin,9-pin	FC
	WSLX-980-005-H	5W	200um	4-pin,9-pin	FC
	WSLB-980-010-H	10W	400um	P2	FC

Leading Supplier of Fiber Coupled Diode Laser

Wavelength	Part Number	Output Power	Fiber Core	Package	Connector
980nm	WSLB-980-012-H	12W	400um	P2	FC
	WSLB-980-015-H	15W	400um	P2	FC
	WSLB-980-XXX-H	Customized	Customized	HHL	FC

Wavelength	Part Number	Output Power	Fiber Core	Package	Connector
1060nm	WSLP-1060-001-M	1.5W	105um	Coaxial	FC
	WSLP-1060-002-M	2W	105um	Coaxial	FC
	WSLX-1060-001-H	1.5W	105um	2-pin,4-pin	FC
	WSLX-1060-002-H	2W	105um	2-pin,4-pin	FC
	WSLB-1060-010-H	10W	400um	P2	FC
	WSLB-1060-012-H	12W	400um	P2	FC
	WSLB-1060-015-H	15W	400um	P2	FC
	WSLB-1060-XXX-H	Customized	Customized	HHL	FC

Wavelength	Part Number	Output Power	Fiber Core	Package	Connector
1310nm	WSLP-1310-010m-M-PD	10mW	62.5um,105um	Coaxial	FC
	WSLP-1310-XXX-M	Customized	Customized	Coaxial	FC

Wavelength	Part Number	Output Power	Fiber Core	Package	Connector
1450nm	WSLP-1450-350m-M	350mW	105um	Coaxial	FC
	WSLX-1450-400m-H	400W	105um	4-pin	FC
	WSLB-1450-001-H	1W	200um	P2	FC
	WSLB-1450-002-H	2W	400um	P2	FC
	WSLB-1450-007-H	7W	600um	P2	FC
	WSLB-1450-015-H	15W	800um	P2	FC
	WSLB-1450-XXX-H	Customized	Customized	HHL	FC

Wavelength	Part Number	Output Power	Fiber Core	Package	Connector
1470nm	WSLP-1470-500m-M	500mW	105um	Coaxial	FC
	WSLX-1470-600m-H	600mW	105um	4-pin	FC
	WSLB-1470-003-H	3W	400um	P2	FC
	WSLB-1470-005-H	5W	600um	P2	FC



Wavelength	Part Number	Output Power	Fiber Core	Package	Connector
1470nm	WSLB-1470-012-H	12W	600um	P2	FC
	WSLB-1470-XXX-H	Customized	Customized	HHL	FC

Wavelength	Part Number	Output Power	Fiber Core	Package	Connector
1550nm	WSP-1550-010m-M-PD	10mW	62.5um,105um	Coaxial	FC
	WSP-1550-500m-M	500mW	105um	Coaxial	FC
	WSLX-1550-600m-H	600mW	105um	4-pin	FC
	WSLB-1550-003-H	3W	400um	P2	FC
	WSLB-1550-005-H	5W	600um	P2	FC
	WSLB-1550-012-H	12W	600um	P2	FC
	WSLB-1550-XXX-H	Customized	Customized	HHL	FC

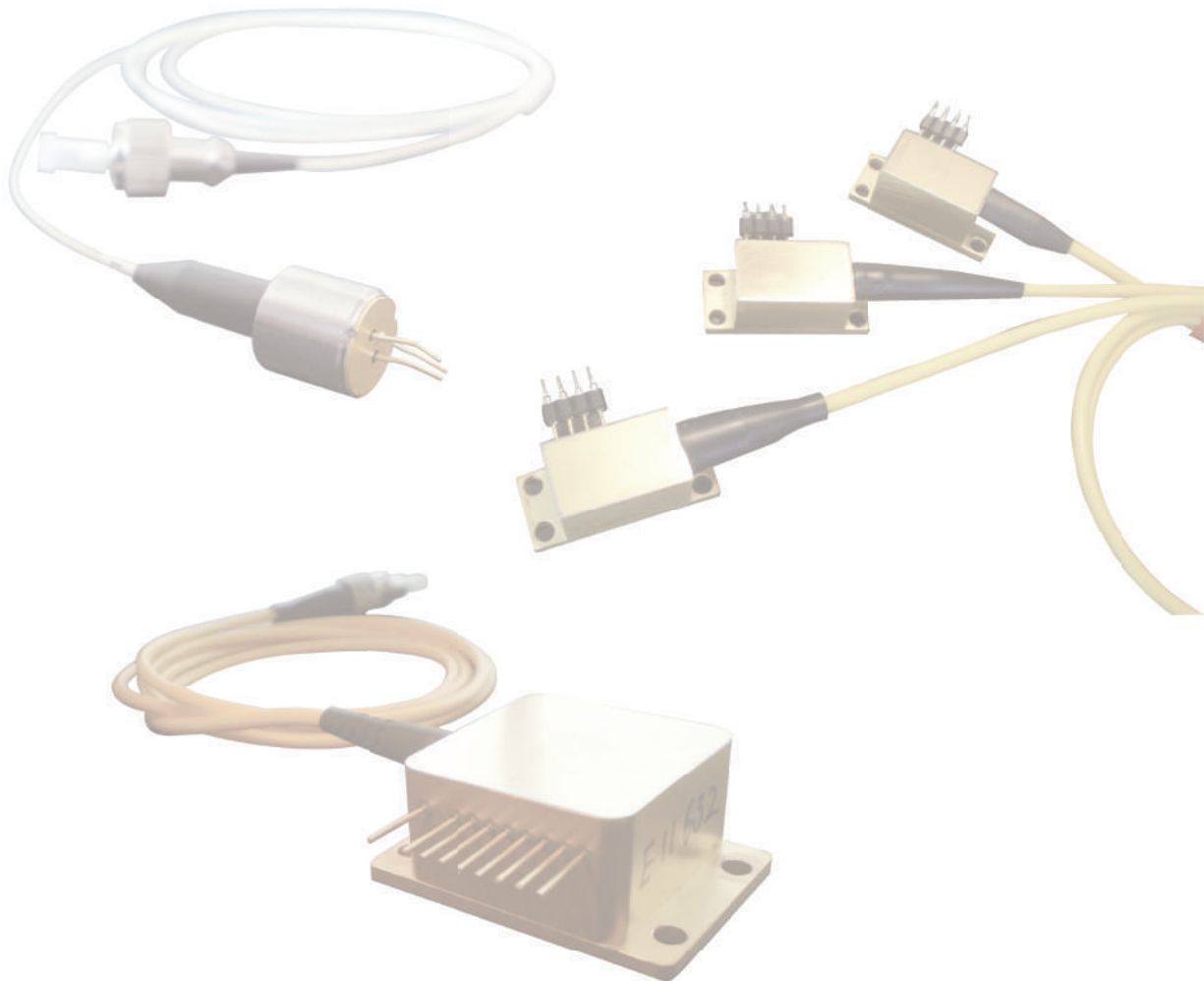



Dual(Tri)-wavelength Fiber Coupled Laser Diode

- 405nm~1550nm Optional
- P2 Package
- 50mW~30W Output Power
- Built-in TEC Cooling
- OEM Multi-wavelength Module
- Customized Wavelength
- Customized Output Power

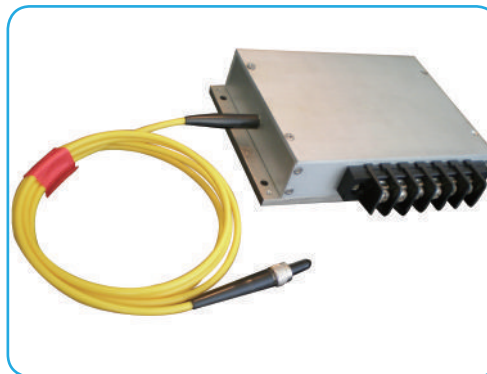

Optional Wavelength	405nm 445nm 635nm 650nm 785nm 793nm 808nm 830nm 850nm 880nm 905nm 915nm 940nm 980nm 1064nm 1450nm 1470nm 1550nm Optional	
Fiber Core	200um 400um 600um 800um Optional	
Connector	SMA905 FC	
Cooling	Built-in TEC Cooling	
Aiming Beam	External Receptacle Aiming Beam for IR Laser	
OEM Design	Dual-Wavelength Module	Such as 350mw@635nm + 10w@808nm
	Tri-Wavelength Module	Such as 450mw@405nm + 350mw@635nm +5W@808nm
	Multi-Wavelength Module	405nm~1550nm Optional

Multi-wavelength Fiber Coupled LD



External Receptacle Aiming Beam





3-Channel Fiber Coupled Laser System

- 375nm~1610nm Optional
- 1mW~200mW
- Turnkey System
- SM/MM/PM Fiber Optional
- Multi-Channel Optional
- Multi-Wavelength Optional



Type	Part Number	Channel	Wavelength	Output Power	Fiber Type	Fiber Core
3-Wavelength Laser System	WSLS-A-3C-010m-4	Channel 1	405nm	10mW	SM	3um
		Channel 2	532nm	10mW	SM	4um
		Channel 3	650nm	10mW	SM	4um

Type	Part Number	Wavelength	Channel Number	Output Power	Fiber Type	Fiber Core
3-Channel Laser System	WSLS-405-3C-010m-4	405nm	3	10mW	SM	3um
	WSLS-670-3C-001m-4	670nm	3	1mW	SM	4um

Offer Customized Multi-Channel Fiber Coupled Laser System

Optional Wavelength	375nm 405nm 445nm 488nm 532nm 635nm 650nm 785nm 793nm 808nm 830nm 850nm 880nm 905nm 915nm 940nm 980nm 1064nm 1450nm 1470nm 1550nm Optional					
Fiber Type	SM PM MM Fiber Optional					
Connector	SMA905 FC					
Cooling	Built-in TEC Cooling					
Channel Number	Customized					
Focus Lens	Optional (spot size@ distance)					
OEM Design	3-Wavelength System	Such as 10mw@405nm+10mw@532nm+10mw@635nm				
	3-Channel System	Such as 1mw@670nm+1mw@670nm+1mw@670nm				
	Multi-Wavelength System	405nm~1550nm Optional				
	Multi-Channel System	Channel Number Optional				



Coaxial & Receptacle Package Photodiodes

- SI and InGaAs Photodiodes
- Coaxial / Receptacle Package

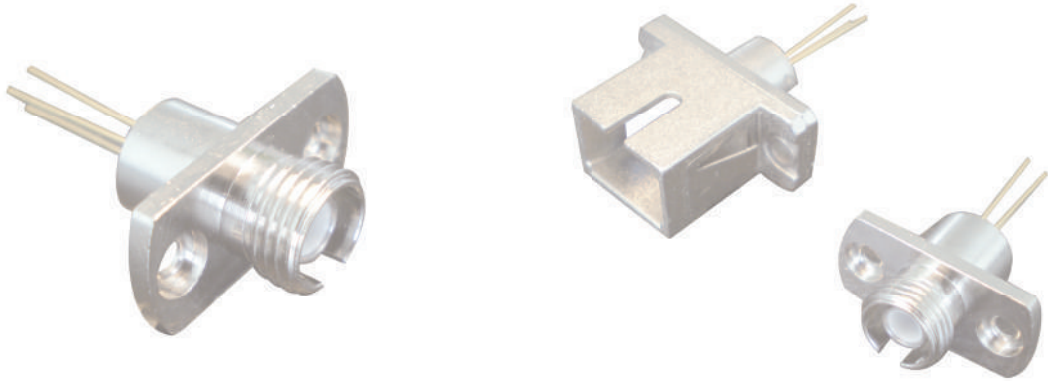
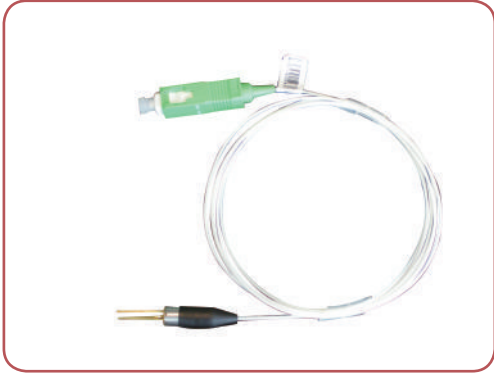

Part Number	PD Type	Response Wavelength	Photosensitive area	Package	Fiber Core
WSPP-IGA-55-9	InGaAs	1100nm~1650nm	55um	Coaxial	9um
WSPP-IGA-80-9	InGaAs	1100nm~1650nm	80um	Coaxial	9um
WSPP-IGA-300-9	InGaAs	1100nm~1650nm	300um	Coaxial	9um
WSPP-IGA-1000-9	InGaAs	1100nm~1650nm	1000um	Coaxial	9um
WSPR-IGA-55	InGaAs	1100nm~1650nm	55um	Receptacle	without Fiber
WSPR-IGA-80	InGaAs	1100nm~1650nm	80um	Receptacle	without Fiber
WSPR-IGA-300	InGaAs	1100nm~1650nm	300um	Receptacle	without Fiber
WSPR-IGA-1000	InGaAs	1100nm~1650nm	1000um	Receptacle	without Fiber

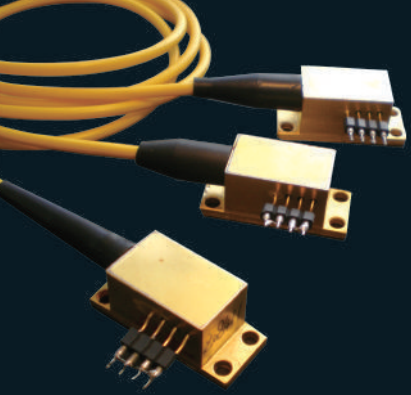

Wavespectrum Laser, Inc.



Wavespectrum Laser, Inc.

Address: 801 Wenlin Plaza Beijing 100081 China

Tel: +86-10-8303 6245

Fax: +86-10-6216 6727

Web: www.wavespectrum-laser.com

Email: info@wavespectrum-laser.com

Germany Distributor:

EQ Photonics GmbH

Address: Obere Hauptstr. 30, 85386 Eching, Germany

Tel: +49-89-319019 0

Fax: +49-89-319019 49

Web: www.eqphotonics.de

E-Mail: info@eqphotonics.de

Distributors Wanted World-Wide!