

TL343 SINGLE LOW-POWER OPERATIONAL AMPLIFIER

SLOS250G – JUNE 1999 – REVISED JANUARY 2005

- Wide Range of Supply Voltages, Single Supply 3 V to 30 V, or Dual Supplies
- Class AB Output Stage
- True Differential-Input Stage
- Low Input Bias Current
- Internal Frequency Compensation
- Short-Circuit Protection

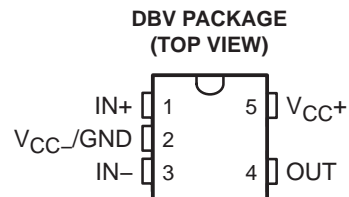

description/ordering information

The TL343 is a single operational amplifier similar in performance to the μ A741, but with several distinct advantages. It is designed to operate from a single supply over a range of voltages from 3 V to 30 V. Operation from split supplies also is possible, provided the difference between the two supplies is 3 V to 30 V. The common-mode input range includes the negative supply. Output range is from the negative supply to $V_{CC} - 1.5$ V.

ORDERING INFORMATION

T_A	$V_{IO\text{MAX}}$ AT 25°C	PACKAGE†	ORDERABLE PART NUMBER	TOP-SIDE MARKING‡
–40°C to 125°C	10 mV	SOT-23-5 (DBV)	Reel of 3000	TL343IDBVR
			Reel of 250	TL343IDBVT
				T4I_

† Package drawings, standard packing quantities, thermal data, symbolization, and PCB design guidelines are available at www.ti.com/sc/package.

‡ The actual top-side marking has one additional character that designates the assembly/test site.

symbol

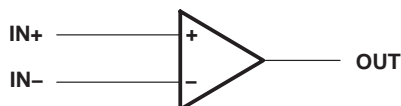

Please be aware that an important notice concerning availability, standard warranty, and use in critical applications of Texas Instruments semiconductor products and disclaimers thereto appears at the end of this data sheet.

PRODUCTION DATA information is current as of publication date. Products conform to specifications per the terms of Texas Instruments standard warranty. Production processing does not necessarily include testing of all parameters.

 **TEXAS
INSTRUMENTS**

POST OFFICE BOX 655303 • DALLAS, TEXAS 75265

Copyright © 2005, Texas Instruments Incorporated

TL343 SINGLE LOW-POWER OPERATIONAL AMPLIFIER

SLOS250G – JUNE 1999 – REVISED JANUARY 2005

schematic

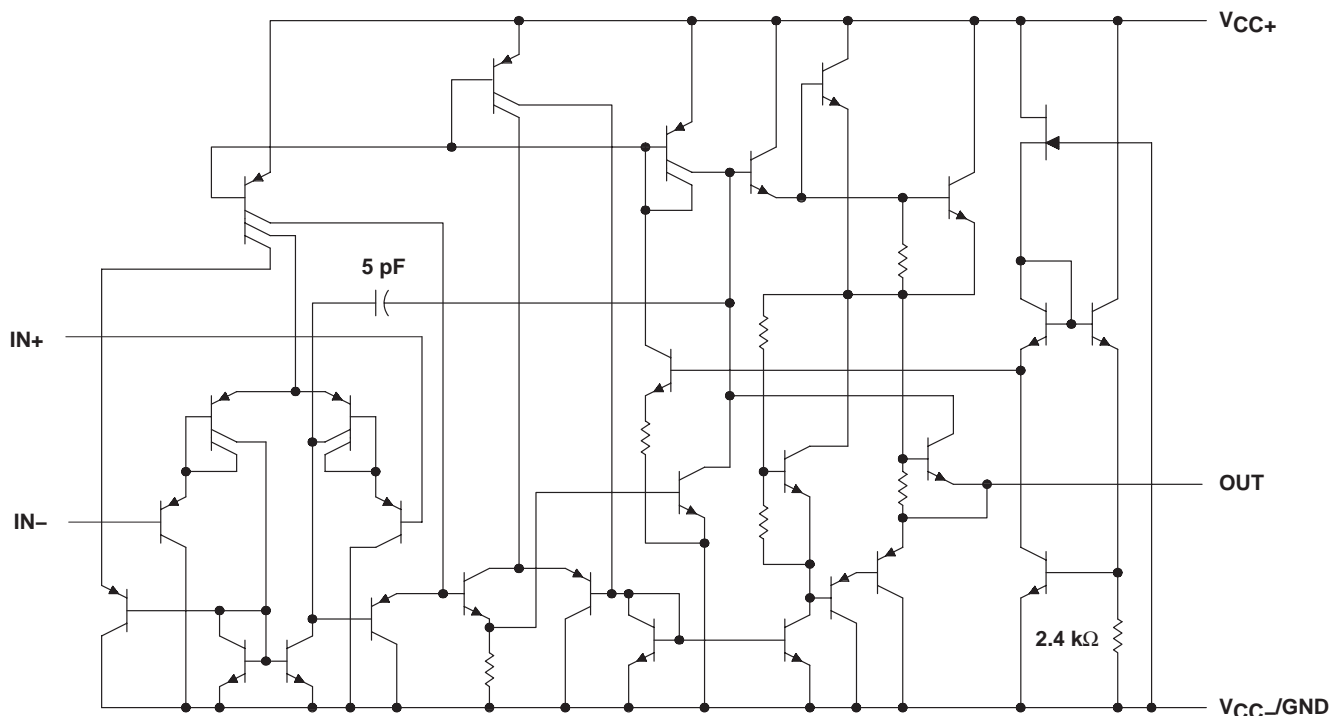

NOTE A: Component values shown are nominal.

absolute maximum ratings over operating free-air temperature range (unless otherwise noted)

	MAX	UNIT	
Supply voltage (see Note 1)	V _{CC+}	18	V
	V _{CC-}	-18	
Supply voltage, V _{CC+} with respect to V _{CC-}	36	V	
Differential input voltage (see Note 2)	±36	V	
Input voltage (see Notes 1 and 3)	±18	V	
Package thermal impedance, θ_{JA} (see Notes 4 and 5)	206	°C/W	
Operating virtual junction temperature, T _J	150	°C	
Storage temperature range, T _{stg}	-65 to 150	°C	

- NOTES:
1. These voltage values are with respect to the midpoint between V_{CC+} and V_{CC-}.
 2. Differential voltages are at IN+ with respect to IN-.
 3. Neither input must ever be more positive than V_{CC+} or more negative than V_{CC-}.
 4. Maximum power dissipation is a function of T_{J(max)}, θ_{JA} , and T_A. The maximum allowable power dissipation at any allowable ambient temperature is $P_D = (T_J(max) - T_A) / \theta_{JA}$. Selecting the maximum of 150°C can affect reliability.
 5. The package thermal impedance is calculated in accordance with JESD 51-7.

TL343

SINGLE LOW-POWER OPERATIONAL AMPLIFIER

SLOS250G – JUNE 1999 – REVISED JANUARY 2005

recommended operating conditions

		MIN	MAX	UNIT
V_{CC}	Single-supply voltage	3	30	V
V_{CC+}	Dual-supply voltage	1.5	15	V
V_{CC-}		-1.5	-15	
T_A	Operating free-air temperature	-40	125	°C

electrical characteristics at specified free-air temperature, $V_{CC\pm} = \pm 15$ V (unless otherwise noted)

PARAMETER	TEST CONDITION [†]	MIN	TYP	MAX	UNIT
V_{IO} Input offset voltage	See Note 6	25°C	2	10	mV
		Full range		12	
$\alpha_{V_{IO}}$ Temperature coefficient of input offset voltage	See Note 6	Full range	10		$\mu\text{V}/^\circ\text{C}$
I_{IO} Input offset current	See Note 6	25°C	30	50	nA
		Full range		200	
$\alpha_{I_{IO}}$ Temperature coefficient of input offset current	See Note 6	Full range	50		$\text{pA}/^\circ\text{C}$
I_{IB} Input bias current	See Note 6	25°C	-200	-500	nA
		Full range		-800	
V_{ICR} Common-mode input voltage range [‡]		25°C	V_{CC-} to 13	V_{CC-} to 13.5	V
V_{OM} Peak output-voltage swing	$R_L = 10\text{ k}\Omega$	25°C	± 12	± 13.5	V
	$R_L = 2\text{ k}\Omega$	25°C	± 10	± 13	
		Full range		± 10	
A_{VD} Large-signal differential voltage amplification	$V_O = \pm 10\text{ V}$, $R_L = 2\text{ k}\Omega$	25°C	20	200	V/mV
		Full range	15		
B_{OM} Maximum-output-swing bandwidth	$V_{OPP} = 20\text{ V}$, $\text{THD} \leq 5\%$, $R_L = 2\text{ k}\Omega$	25°C	9		kHz
B_1 Unity-gain bandwidth	$V_O = 50\text{ mV}$, $R_L = 10\text{ k}\Omega$	25°C	1		MHz
ϕ_m Phase margin	$C_L = 200\text{ pF}$, $R_L = 2\text{ k}\Omega$	25°C	44		Deg
r_i Input resistance	$f = 20\text{ Hz}$	25°C	0.3	1	$\text{M}\Omega$
r_o Output resistance	$f = 20\text{ Hz}$	25°C	75		Ω
CMRR Common-mode rejection ratio	$V_{IC} = V_{ICR}(\text{min})$	25°C	70	90	dB
k_{SVS} Supply-voltage sensitivity ($\Delta V_{IO}/\Delta V_{CC}$)	$V_{CC\pm} = \pm 2.5$ to $\pm 15\text{ V}$	25°C	30	150	$\mu\text{V}/\text{V}$
I_{OS} Short-circuit output current [§]		25°C	± 10	± 30 ± 55	mA
I_{CC} Total supply current	No load, See Note 6	25°C	0.7	2.8	mA

[†] All characteristics are measured under open-loop conditions, with zero common-mode voltage, unless otherwise specified. Full range for T_A is -40°C to 125°C.

[‡] The V_{ICR} limits are linked directly, volt-for-volt, to supply voltage; the positive limit is 2 V less than V_{CC+} .

[§] Temperature and/or supply voltages must be limited to ensure that the dissipation rating is not exceeded.

NOTE 6: V_{IO} , I_{IO} , I_{IB} , and I_{CC} are defined at $V_O = 0$.

TL343

SINGLE LOW-POWER OPERATIONAL AMPLIFIER

SLOS250G – JUNE 1999 – REVISED JANUARY 2005

electrical characteristics, $V_{CC+} = 3\text{ V}$ and 5 V , $V_{CC-} = 0\text{ V}$, $T_A = 25^\circ\text{C}$ (unless otherwise noted)

PARAMETER	TEST CONDITION†	MIN	TYP	MAX	UNIT
V_{IO} Input offset voltage	$V_O = 1.5\text{ V}$ and 2.5 V		2	10	mV
I_{IO} Input offset current	$V_O = 1.5\text{ V}$ and 2.5 V		30	50	nA
I_{IB} Input bias current	$V_O = 1.5\text{ V}$ and 2.5 V		-200	-500	nA
V_{OM} Peak output voltage swing‡	$R_L = 10\text{ k}\Omega$	3.3	3.5		V
A_{VD} Large-signal differential voltage amplification	$V_O = 1.7\text{ V}$ to 3.3 V , $R_L = 2\text{ k}\Omega$	20	200		V/mV
k_{SVS} Supply-voltage sensitivity ($\Delta V_{IO}/\Delta V_{CC\pm}$)	$V_{CC\pm} = \pm 2.5\text{ V}$ to $\pm 15\text{ V}$			150	$\mu\text{V}/\text{V}$
I_{CC} Supply current	$V_O = 1.5\text{ V}$ and 2.5 V , No load		0.7	1.75	mA

† All characteristics are measured under open-loop conditions, with zero common-mode input voltage, unless otherwise specified.

‡ Output swings essentially to ground.

operating characteristics, $V_{CC\pm} = \pm 15\text{ V}$, $T_A = 25^\circ\text{C}$, $A_{VD} = 1$ (unless otherwise noted)

PARAMETER	TEST CONDITIONS	TYP	UNIT
SR Slew rate at unity gain	$V_I = \pm 10\text{ V}$, $C_L = 100\text{ pF}$, $R_L = 2\text{ k}\Omega$, See Figure 1	1	$\text{V}/\mu\text{s}$
t_r Rise time	$\Delta V_O = 50\text{ mV}$, $C_L = 100\text{ pF}$, $R_L = 10\text{ k}\Omega$, See Figure 1	0.35	μs
t_f Fall time	$\Delta V_O = 50\text{ mV}$, $C_L = 100\text{ pF}$, $R_L = 10\text{ k}\Omega$, See Figure 1	0.35	μs
Overshoot factor	$\Delta V_O = 50\text{ mV}$, $C_L = 100\text{ pF}$, $R_L = 10\text{ k}\Omega$, See Figure 1	20%	
Crossover distortion	$V_{I(PP)} = 30\text{ mV}$, $V_{OPP} = 2\text{ V}$, $f = 10\text{ kHz}$	1%	

PARAMETER MEASUREMENT INFORMATION

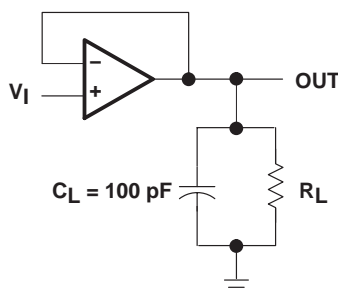

Figure 1. Unity-Gain Amplifier

TYPICAL CHARACTERISTICS†

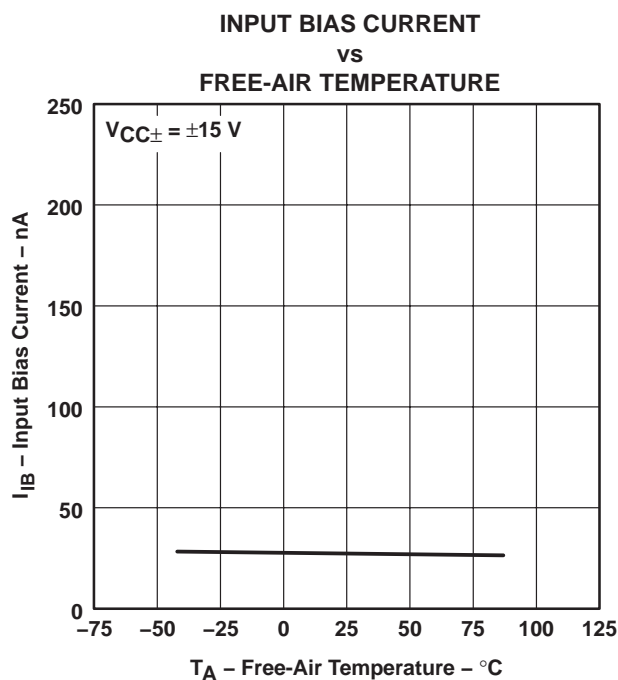

Figure 2

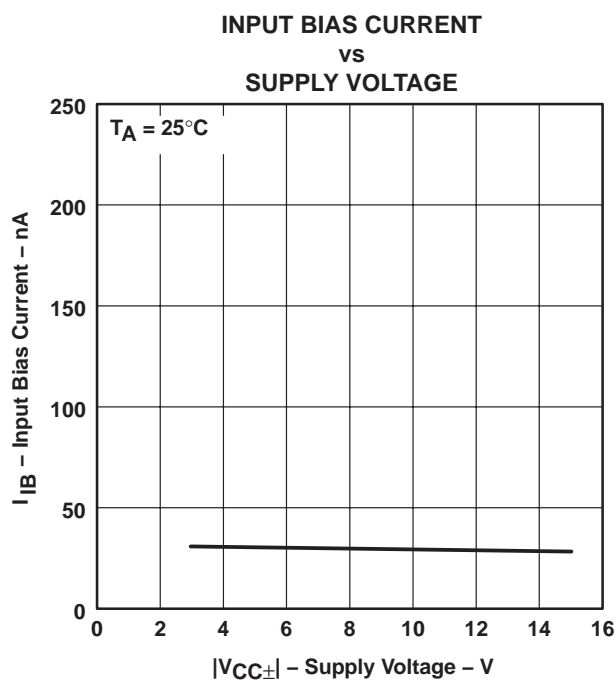

Figure 3

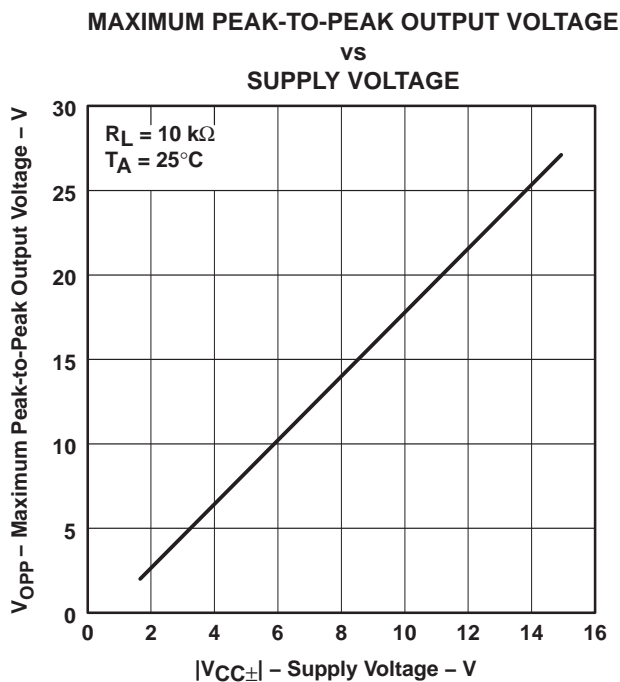

Figure 4

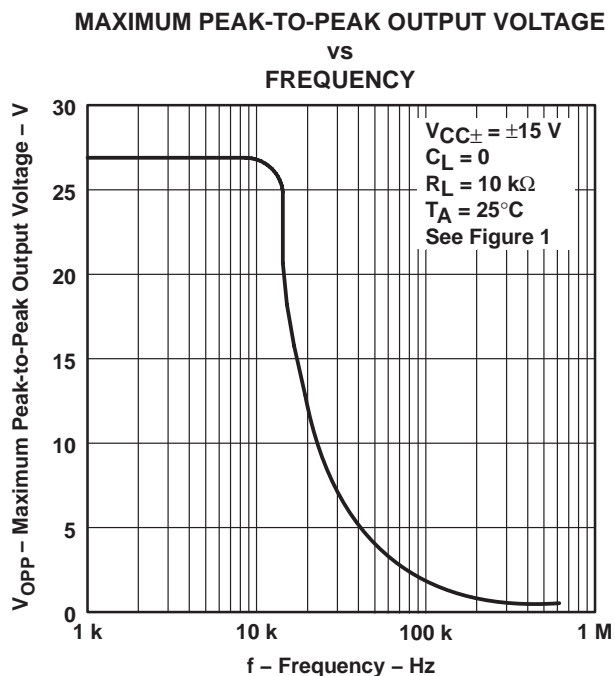

Figure 5

† Operation of the device at these or any other conditions beyond those indicated under "recommended operating conditions" is not implied.

TL343 SINGLE LOW-POWER OPERATIONAL AMPLIFIER

SLOS250G – JUNE 1999 – REVISED JANUARY 2005

TYPICAL CHARACTERISTICS†

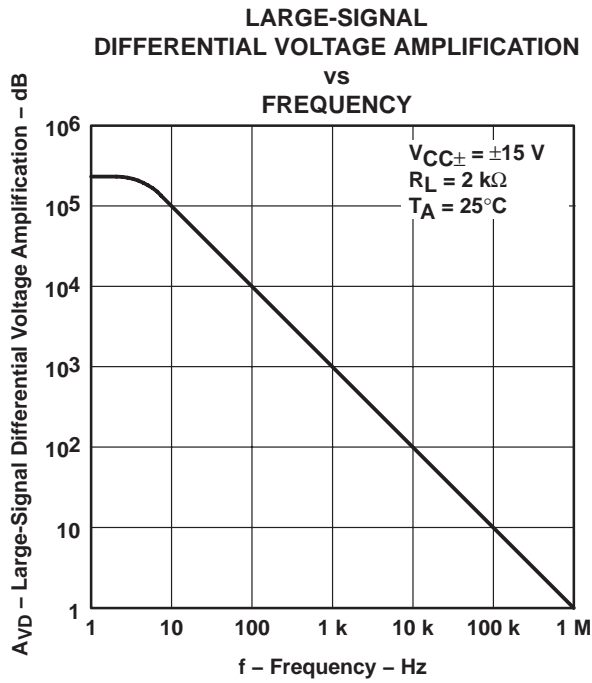

Figure 6

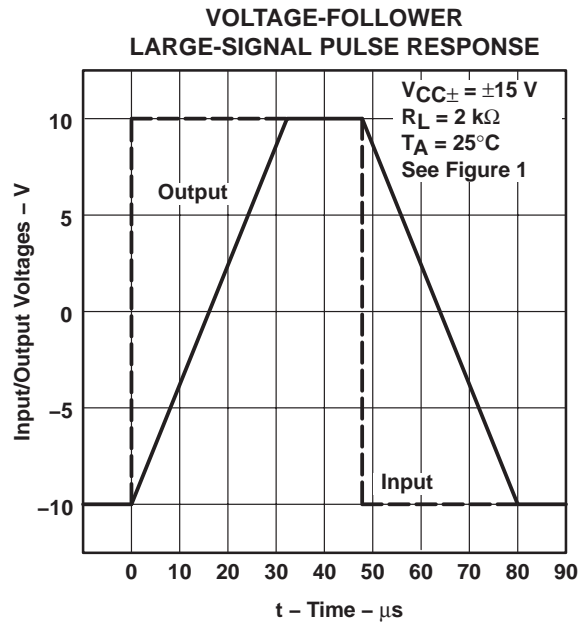

Figure 7

† Operation of the device at these or any other conditions beyond those indicated under “recommended operating conditions” is not implied.

PACKAGING INFORMATION

Orderable Device	Status (1)	Package Type	Package Drawing	Pins	Package Qty	Eco Plan (2)	Lead/Ball Finish (6)	MSL Peak Temp (3)	Op Temp (°C)	Device Marking (4/5)	Samples
TL3431DBVR	ACTIVE	SOT-23	DBV	5	3000	Green (RoHS & no Sb/Br)	CU NIPDAU CU SN	Level-1-260C-UNLIM	-40 to 125	(T4IG, T4IL, T4IS)	Samples
TL3431DBVT	ACTIVE	SOT-23	DBV	5	250	Green (RoHS & no Sb/Br)	CU NIPDAU CU SN	Level-1-260C-UNLIM	-40 to 125	(T4IG, T4IL, T4IU)	Samples

(1) The marketing status values are defined as follows:

ACTIVE: Product device recommended for new designs.

LIFEBUY: TI has announced that the device will be discontinued, and a lifetime-buy period is in effect.

NRND: Not recommended for new designs. Device is in production to support existing customers, but TI does not recommend using this part in a new design.

PREVIEW: Device has been announced but is not in production. Samples may or may not be available.

OBsolete: TI has discontinued the production of the device.

(2) **RoHS:** TI defines "RoHS" to mean semiconductor products that are compliant with the current EU RoHS requirements for all 10 RoHS substances, including the requirement that RoHS substance do not exceed 0.1% by weight in homogeneous materials. Where designed to be soldered at high temperatures, "RoHS" products are suitable for use in specified lead-free processes. TI may reference these types of products as "Pb-Free".

RoHS Exempt: TI defines "RoHS Exempt" to mean products that contain lead but are compliant with EU RoHS pursuant to a specific EU RoHS exemption.

Green: TI defines "Green" to mean the content of Chlorine (Cl) and Bromine (Br) based flame retardants meet JS709B low halogen requirements of <=1000ppm threshold. Antimony trioxide based flame retardants must also meet the <=1000ppm threshold requirement.

(3) MSL, Peak Temp. - The Moisture Sensitivity Level rating according to the JEDEC industry standard classifications, and peak solder temperature.

(4) There may be additional marking, which relates to the logo, the lot trace code information, or the environmental category on the device.

(5) Multiple Device Markings will be inside parentheses. Only one Device Marking contained in parentheses and separated by a "-" will appear on a device. If a line is indented then it is a continuation of the previous line and the two combined represent the entire Device Marking for that device.

(6) Lead/Ball Finish - Orderable Devices may have multiple material finish options. Finish options are separated by a vertical ruled line. Lead/Ball Finish values may wrap to two lines if the finish value exceeds the maximum column width.

Important Information and Disclaimer:The information provided on this page represents TI's knowledge and belief as of the date that it is provided. TI bases its knowledge and belief on information provided by third parties, and makes no representation or warranty as to the accuracy of such information. Efforts are underway to better integrate information from third parties. TI has taken and continues to take reasonable steps to provide representative and accurate information but may not have conducted destructive testing or chemical analysis on incoming materials and chemicals. TI and TI suppliers consider certain information to be proprietary, and thus CAS numbers and other limited information may not be available for release.

In no event shall TI's liability arising out of such information exceed the total purchase price of the TI part(s) at issue in this document sold by TI to Customer on an annual basis.

TAPE AND REEL INFORMATION

QUADRANT ASSIGNMENTS FOR PIN 1 ORIENTATION IN TAPE

*All dimensions are nominal

Device	Package Type	Package Drawing	Pins	SPQ	Reel Diameter (mm)	Reel Width W1 (mm)	A0 (mm)	B0 (mm)	K0 (mm)	P1 (mm)	W (mm)	Pin1 Quadrant
TL343IDBVR	SOT-23	DBV	5	3000	178.0	9.0	3.23	3.17	1.37	4.0	8.0	Q3
TL343IDBVR	SOT-23	DBV	5	3000	180.0	8.4	3.23	3.17	1.37	4.0	8.0	Q3
TL343IDBVT	SOT-23	DBV	5	250	178.0	9.0	3.23	3.17	1.37	4.0	8.0	Q3

TAPE AND REEL BOX DIMENSIONS

*All dimensions are nominal

Device	Package Type	Package Drawing	Pins	SPQ	Length (mm)	Width (mm)	Height (mm)
TL3431DBVR	SOT-23	DBV	5	3000	180.0	180.0	18.0
TL3431DBVR	SOT-23	DBV	5	3000	202.0	201.0	28.0
TL3431DBVT	SOT-23	DBV	5	250	180.0	180.0	18.0

IMPORTANT NOTICE

Texas Instruments Incorporated (TI) reserves the right to make corrections, enhancements, improvements and other changes to its semiconductor products and services per JESD46, latest issue, and to discontinue any product or service per JESD48, latest issue. Buyers should obtain the latest relevant information before placing orders and should verify that such information is current and complete.

TI's published terms of sale for semiconductor products (<http://www.ti.com/sc/docs/stdterms.htm>) apply to the sale of packaged integrated circuit products that TI has qualified and released to market. Additional terms may apply to the use or sale of other types of TI products and services.

Reproduction of significant portions of TI information in TI data sheets is permissible only if reproduction is without alteration and is accompanied by all associated warranties, conditions, limitations, and notices. TI is not responsible or liable for such reproduced documentation. Information of third parties may be subject to additional restrictions. Resale of TI products or services with statements different from or beyond the parameters stated by TI for that product or service voids all express and any implied warranties for the associated TI product or service and is an unfair and deceptive business practice. TI is not responsible or liable for any such statements.

Buyers and others who are developing systems that incorporate TI products (collectively, "Designers") understand and agree that Designers remain responsible for using their independent analysis, evaluation and judgment in designing their applications and that Designers have full and exclusive responsibility to assure the safety of Designers' applications and compliance of their applications (and of all TI products used in or for Designers' applications) with all applicable regulations, laws and other applicable requirements. Designer represents that, with respect to their applications, Designer has all the necessary expertise to create and implement safeguards that (1) anticipate dangerous consequences of failures, (2) monitor failures and their consequences, and (3) lessen the likelihood of failures that might cause harm and take appropriate actions. Designer agrees that prior to using or distributing any applications that include TI products, Designer will thoroughly test such applications and the functionality of such TI products as used in such applications.

TI's provision of technical, application or other design advice, quality characterization, reliability data or other services or information, including, but not limited to, reference designs and materials relating to evaluation modules, (collectively, "TI Resources") are intended to assist designers who are developing applications that incorporate TI products; by downloading, accessing or using TI Resources in any way, Designer (individually or, if Designer is acting on behalf of a company, Designer's company) agrees to use any particular TI Resource solely for this purpose and subject to the terms of this Notice.

TI's provision of TI Resources does not expand or otherwise alter TI's applicable published warranties or warranty disclaimers for TI products, and no additional obligations or liabilities arise from TI providing such TI Resources. TI reserves the right to make corrections, enhancements, improvements and other changes to its TI Resources. TI has not conducted any testing other than that specifically described in the published documentation for a particular TI Resource.

Designer is authorized to use, copy and modify any individual TI Resource only in connection with the development of applications that include the TI product(s) identified in such TI Resource. NO OTHER LICENSE, EXPRESS OR IMPLIED, BY ESTOPPEL OR OTHERWISE TO ANY OTHER TI INTELLECTUAL PROPERTY RIGHT, AND NO LICENSE TO ANY TECHNOLOGY OR INTELLECTUAL PROPERTY RIGHT OF TI OR ANY THIRD PARTY IS GRANTED HEREIN, including but not limited to any patent right, copyright, mask work right, or other intellectual property right relating to any combination, machine, or process in which TI products or services are used. Information regarding or referencing third-party products or services does not constitute a license to use such products or services, or a warranty or endorsement thereof. Use of TI Resources may require a license from a third party under the patents or other intellectual property of the third party, or a license from TI under the patents or other intellectual property of TI.

TI RESOURCES ARE PROVIDED "AS IS" AND WITH ALL FAULTS. TI DISCLAIMS ALL OTHER WARRANTIES OR REPRESENTATIONS, EXPRESS OR IMPLIED, REGARDING RESOURCES OR USE THEREOF, INCLUDING BUT NOT LIMITED TO ACCURACY OR COMPLETENESS, TITLE, ANY EPIDEMIC FAILURE WARRANTY AND ANY IMPLIED WARRANTIES OF MERCHANTABILITY, FITNESS FOR A PARTICULAR PURPOSE, AND NON-INFRINGEMENT OF ANY THIRD PARTY INTELLECTUAL PROPERTY RIGHTS. TI SHALL NOT BE LIABLE FOR AND SHALL NOT DEFEND OR INDEMNIFY DESIGNER AGAINST ANY CLAIM, INCLUDING BUT NOT LIMITED TO ANY INFRINGEMENT CLAIM THAT RELATES TO OR IS BASED ON ANY COMBINATION OF PRODUCTS EVEN IF DESCRIBED IN TI RESOURCES OR OTHERWISE. IN NO EVENT SHALL TI BE LIABLE FOR ANY ACTUAL, DIRECT, SPECIAL, COLLATERAL, INDIRECT, PUNITIVE, INCIDENTAL, CONSEQUENTIAL OR EXEMPLARY DAMAGES IN CONNECTION WITH OR ARISING OUT OF TI RESOURCES OR USE THEREOF, AND REGARDLESS OF WHETHER TI HAS BEEN ADVISED OF THE POSSIBILITY OF SUCH DAMAGES.

Unless TI has explicitly designated an individual product as meeting the requirements of a particular industry standard (e.g., ISO/TS 16949 and ISO 26262), TI is not responsible for any failure to meet such industry standard requirements.

Where TI specifically promotes products as facilitating functional safety or as compliant with industry functional safety standards, such products are intended to help enable customers to design and create their own applications that meet applicable functional safety standards and requirements. Using products in an application does not by itself establish any safety features in the application. Designers must ensure compliance with safety-related requirements and standards applicable to their applications. Designer may not use any TI products in life-critical medical equipment unless authorized officers of the parties have executed a special contract specifically governing such use. Life-critical medical equipment is medical equipment where failure of such equipment would cause serious bodily injury or death (e.g., life support, pacemakers, defibrillators, heart pumps, neurostimulators, and implantables). Such equipment includes, without limitation, all medical devices identified by the U.S. Food and Drug Administration as Class III devices and equivalent classifications outside the U.S.

TI may expressly designate certain products as completing a particular qualification (e.g., Q100, Military Grade, or Enhanced Product). Designers agree that it has the necessary expertise to select the product with the appropriate qualification designation for their applications and that proper product selection is at Designers' own risk. Designers are solely responsible for compliance with all legal and regulatory requirements in connection with such selection.

Designer will fully indemnify TI and its representatives against any damages, costs, losses, and/or liabilities arising out of Designer's non-compliance with the terms and provisions of this Notice.