

Features

- Low-voltage and Standard-voltage Operation
 - 1.8 ($V_{CC} = 1.8V$ to 5.5V)
- Internally Organized as 32,768 x 8
- Two-wire Serial Interface
- Schmitt Trigger, Filtered Inputs for Noise Suppression
- Bidirectional Data Transfer Protocol
- 1 MHz (5.0V, 2.7V, 2.5V), and 400 kHz (1.8V) Compatibility
- Write Protect Pin for Hardware and Software Data Protection
- 64-byte Page Write Mode (Partial Page Writes Allowed)
- Self-timed Write Cycle (5 ms Max)
- High Reliability
 - Endurance: One Million Write Cycles
 - Data Retention: 40 Years
- Lead-free/Halogen-free Devices Available
- 8-lead JEDEC PDIP, 8-lead JEDEC SOIC, EIAJ SOIC, 8-lead Ultra Thin Small Array Package (SAP), 8-lead TSSOP, and 8-ball dBGAs Packages
- Die Sales: Wafer Form, Waffle Pack and Bumped Wafers

Description

The AT24C256B provides 262,144 bits of serial electrically erasable and programmable read-only memory (EEPROM) organized as 32,768 words of 8 bits each. The device's cascadable feature allows up to eight devices to share a common two-wire bus. The device is optimized for use in many industrial and commercial applications where low-power and low-voltage operation are essential. The devices are available in space-saving 8-lead JEDEC PDIP, 8-lead JEDEC SOIC, 8-lead Ultra Thin SAP, 8-lead TSSOP, and 8-ball dBGAs packages. In addition, the entire family is available in a 1.8V (1.8V to 5.5V) version.

Pin Configurations

Pin Name	Function
A0–A2	Address Inputs
SDA	Serial Data
SCL	Serial Clock Input
WP	Write Protect
GND	Ground

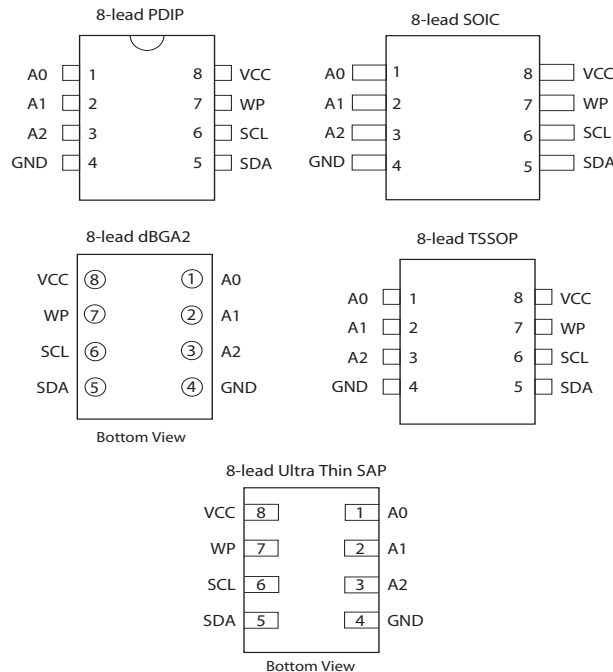

Two-wire Serial EEPROM

256K (32,768 x 8)

AT24C256B

Not Recommended for New Design



1. Absolute Maximum Ratings*

Operating Temperature	- 55°C to +125°C
Storage Temperature.....	- 65°C to +150°C
Voltage on Any Pin with Respect to Ground	- 1.0V to +7.0V
Maximum Operating Voltage	6.25V
DC Output Current.....	5.0 mA

*NOTICE: Stresses beyond those listed under “Absolute Maximum Ratings” may cause permanent damage to the device. This is a stress rating only; functional operation of the device at these or any other conditions beyond those indicated in the operational sections of this specification is not implied. Exposure to absolute maximum rating conditions for extended periods may affect device reliability.

Figure 1-1. Block Diagram

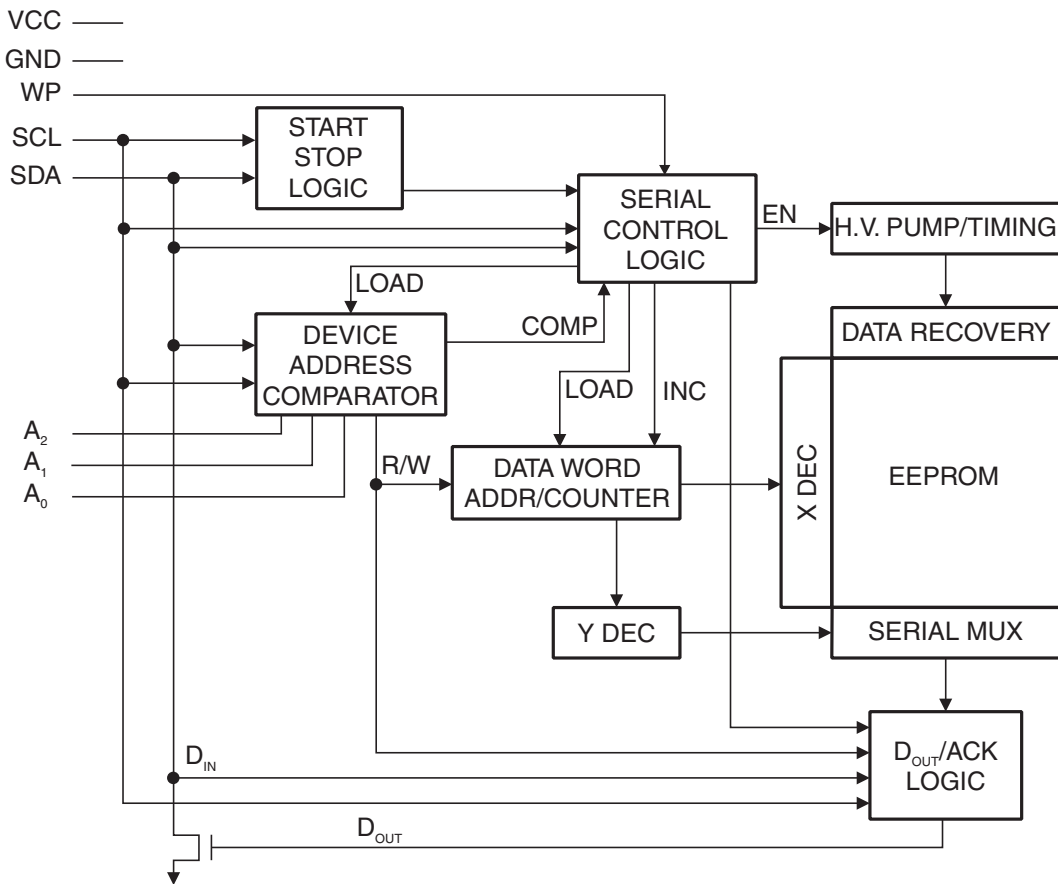

2. Pin Description

SERIAL CLOCK (SCL): The SCL input is used to positive-edge clock data into each EEPROM device and negative-edge clock data out of each device.

SERIAL DATA (SDA): The SDA pin is bidirectional for serial data transfer. This pin is open-drain driven and may be wire-ORed with any number of other open-drain or open-collector devices.

DEVICE/PAGE ADDRESSES (A2, A1, A0): The A2, A1, and A0 pins are device address inputs that are hardwired (directly to GND or to Vcc) for compatibility with other AT24Cxx devices. When the pins are hardwired, as many as eight 256K devices may be addressed on a single bus system. (Device addressing is discussed in detail under “Device Addressing,” page 9.) A device is selected when a corresponding hardware and software match is true. If these pins are left floating, the A2, A1, and A0 pins will be internally pulled down to GND. However, due to capacitive coupling that may appear during customer applications, Atmel recommends always connecting the address pins to a known state. When using a pull-up resistor, Atmel recommends using 10kΩ or less.

WRITE PROTECT (WP): The write protect input, when connected to GND, allows normal write operations. When WP is connected directly to Vcc, all write operations to the memory are inhibited. If the pin is left floating, the WP pin will be internally pulled down to GND. However, due to capacitive coupling that may appear during customer applications, Atmel recommends always connecting the WP pins to a known state. When using a pull-up resistor, Atmel recommends using 10kΩ or less.

3. Memory Organization

AT24C256B, 256K SERIAL EEPROM: The 256K is internally organized as 512 pages of 64 bytes each. Random word addressing requires a 15-bit data word address.

Table 3-1. Pin Capacitance⁽¹⁾

Applicable over recommended operating range from T_A = 25°C, f = 1.0 MHz, V_{CC} = +1.8V

Symbol	Test Condition	Max	Units	Conditions
C _{I/O}	Input/Output Capacitance (SDA)	8	pF	V _{I/O} = 0V
C _{IN}	Input Capacitance (A ₀ , A ₁ , SCL)	6	pF	V _{IN} = 0V

Note: 1. This parameter is characterized and is not 100% tested.

Table 3-2. DC Characteristics

 Applicable over recommended operating range from: $T_{AI} = -40^{\circ}\text{C}$ to $+85^{\circ}\text{C}$, $V_{CC} = +1.8\text{V}$ to $+5.5\text{V}$ (unless otherwise noted)

Symbol	Parameter	Test Condition		Min	Typ	Max	Units
V_{CC1}	Supply Voltage			1.8		5.5	V
I_{CC1}	Supply Current	$V_{CC} = 5.0\text{V}$	READ at 400 kHz		1.0	2.0	mA
I_{CC2}	Supply Current	$V_{CC} = 5.0\text{V}$	WRITE at 400 kHz		2.0	3.0	mA
I_{SB1}	Standby Current (1.8V option)	$V_{CC} = 1.8\text{V}$	$V_{IN} = V_{CC}$ or V_{SS}			1.0	μA
		$V_{CC} = 5.5\text{V}$				6.0	μA
I_{LI}	Input Leakage Current $V_{CC} = 5.0\text{V}$	$V_{IN} = V_{CC}$ or V_{SS}			0.10	3.0	μA
I_{LO}	Output Leakage Current $V_{CC} = 5.0\text{V}$	$V_{OUT} = V_{CC}$ or V_{SS}			0.05	3.0	μA
V_{IL}	Input Low Level ⁽¹⁾			-0.6		$V_{CC} \times 0.3$	V
V_{IH}	Input High Level ⁽¹⁾			$V_{CC} \times 0.7$		$V_{CC} + 0.5$	V
V_{OL2}	Output Low Level	$V_{CC} = 3.0\text{V}$	$I_{OL} = 2.1\text{ mA}$			0.4	V
V_{OL1}	Output Low Level	$V_{CC} = 1.8\text{V}$	$I_{OL} = 0.15\text{ mA}$			0.2	V

 Notes: 1. V_{IL} min and V_{IH} max are reference only and are not tested.

Table 3-3. AC Characteristics (Industrial Temperature)

Applicable over recommended operating range from $T_{AI} = -40^{\circ}\text{C}$ to $+85^{\circ}\text{C}$, $V_{CC} = +1.8\text{V}$ to $+5.5\text{V}$, $CL = 100\text{ pF}$ (unless otherwise noted). Test conditions are listed in Note 2.

Symbol	Parameter	1.8-volt		2.5, 5.0-volt		Units
		Min	Max	Min	Max	
f_{SCL}	Clock Frequency, SCL		400		1000	kHz
t_{LOW}	Clock Pulse Width Low	1.3		0.4		μs
t_{HIGH}	Clock Pulse Width High	0.6		0.4		μs
t_i	Noise Suppression Time ⁽¹⁾		100		50	ns
t_{AA}	Clock Low to Data Out Valid	0.05	0.9	0.05	0.55	μs
t_{BUF}	Time the bus must be free before a new transmission can start ⁽¹⁾	1.3		0.5		μs
$t_{HD,STA}$	Start Hold Time	0.6		0.25		μs
$t_{SU,STA}$	Start Set-up Time	0.6		0.25		μs
$t_{HD,DAT}$	Data In Hold Time	0		0		μs
$t_{SU,DAT}$	Data In Set-up Time	100		100		ns
t_R	Inputs Rise Time ⁽¹⁾		0.3		0.3	μs
t_F	Inputs Fall Time ⁽¹⁾		300		100	ns
$t_{SU,STO}$	Stop Set-up Time	0.6		0.25		μs
t_{DH}	Data Out Hold Time	50		50		ns
t_{WR}	Write Cycle Time		5		5	ms
Endurance ⁽¹⁾	25°C, Page Mode, 3.3V	1,000,000				Write Cycles

Notes: 1. This parameter is ensured by characterization and is not 100% tested.

2. AC measurement conditions:

R_L (connects to V_{CC}): 1.3 k Ω (2.5V, 5.5V), 10 k Ω (1.8V)

Input pulse voltages: 0.3 V_{CC} to 0.7 V_{CC}

Input rise and fall times: $\leq 50\text{ ns}$

Input and output timing reference voltages: 0.5 V_{CC}

4. Device Operation

CLOCK and DATA TRANSITIONS: The SDA pin is normally pulled high with an external device. Data on the SDA pin may change only during SCL low time periods (see [Figure 4-1](#)). Data changes during SCL high periods will indicate a start or stop condition as defined below.

Figure 4-1. Data Validity

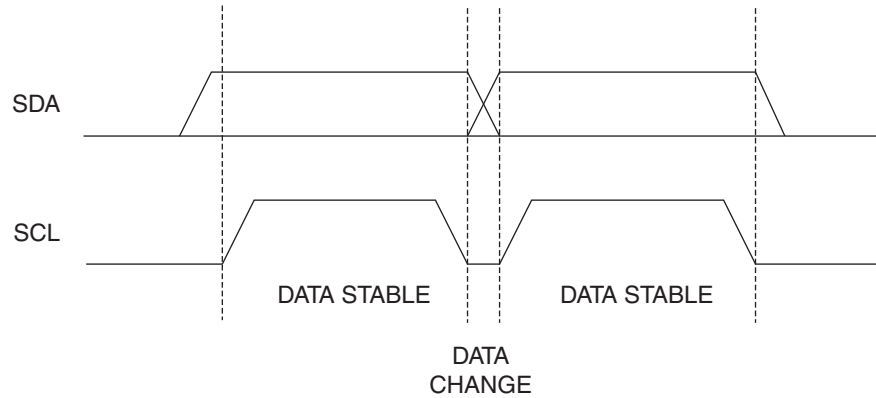

START CONDITION: A high-to-low transition of SDA with SCL high is a start condition that must precede any other command (see [Figure 4-2](#)).

Figure 4-2. Start and Stop Definition

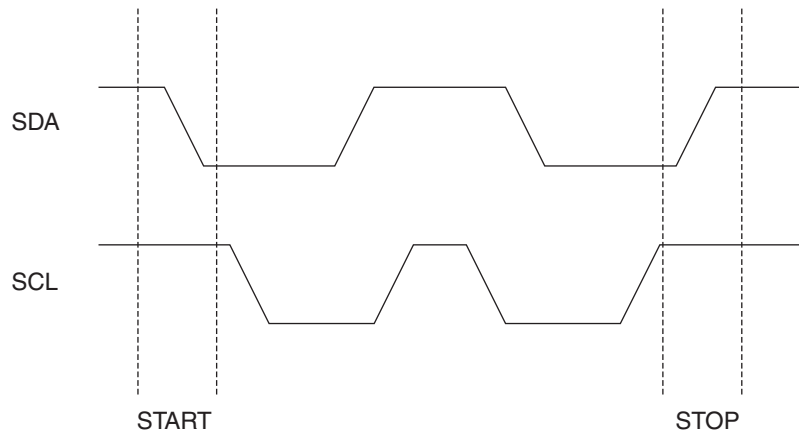

STOP CONDITION: A low-to-high transition of SDA with SCL high is a stop condition. After a read sequence, the stop command will place the EEPROM in a standby power mode (see [Figure 4-2](#)).

ACKNOWLEDGE: All addresses and data words are serially transmitted to and from the EEPROM in 8-bit words. The EEPROM sends a “0” during the ninth clock cycle to acknowledge that it has received each word.

STANDBY MODE: The AT24C256B features a low-power standby mode that is enabled upon power-up and after the receipt of the stop bit and the completion of any internal operations.

SOFTWARE RESET: After an interruption in protocol, power loss or system reset, any 2-wire part can be protocol reset by following these steps: (a) Create a start bit condition, (b) clock 9 cycles, (c) create another start bit followed by stop bit condition as shown below. The device is ready for next communication after above steps have been completed.

Figure 4-3. Software Reset

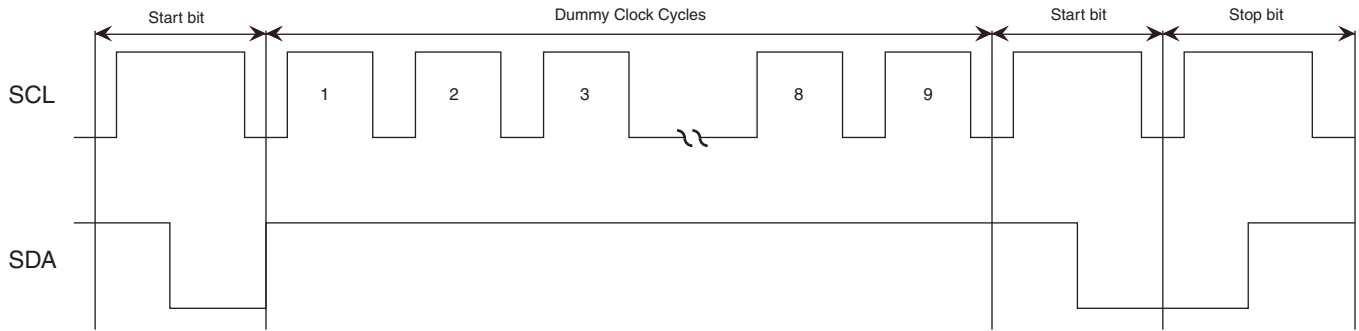

Figure 4-4. Bus Timing

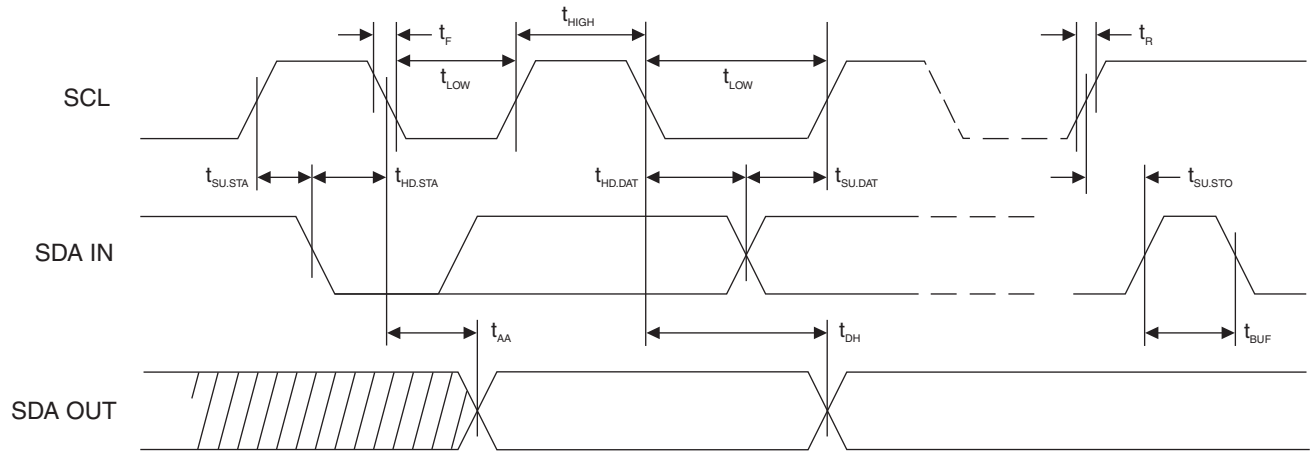
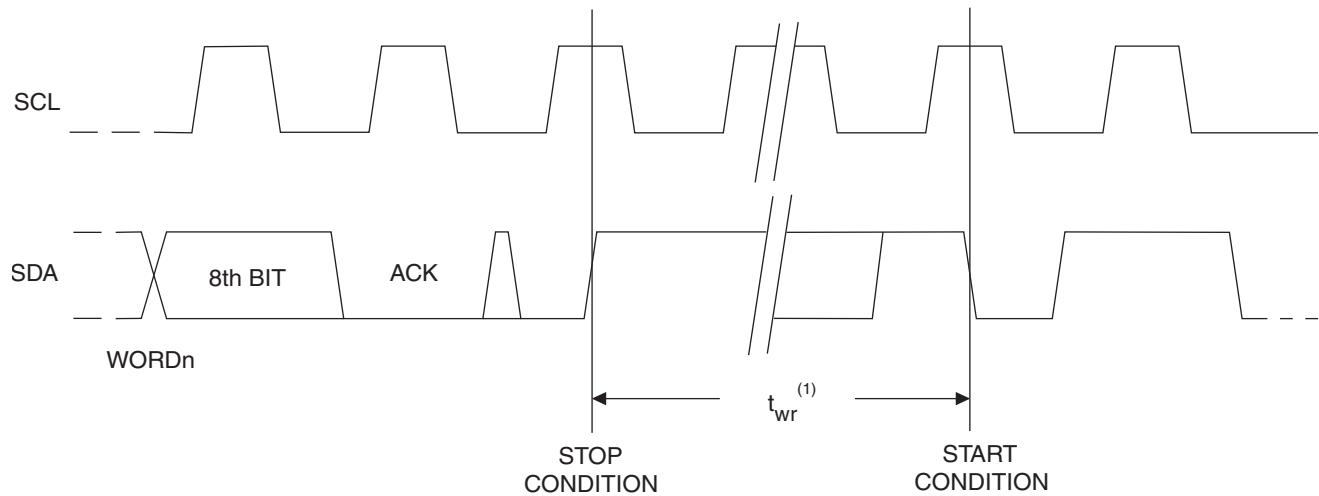
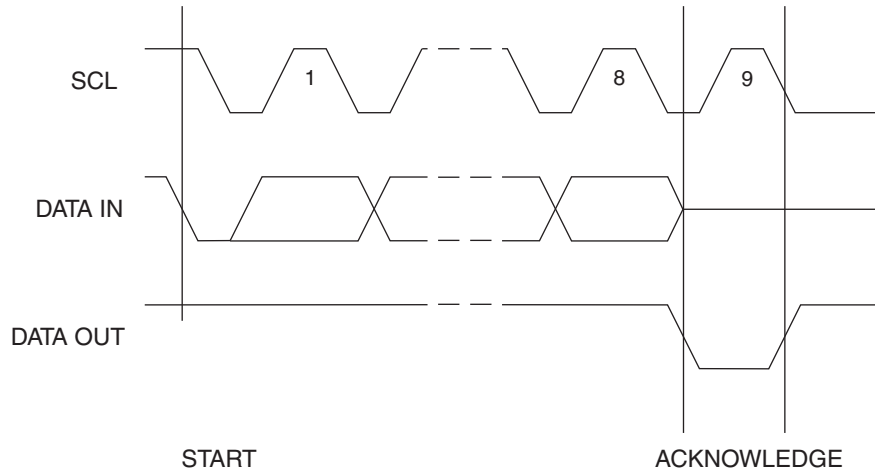

Figure 4-5. Write Cycle Timing



Note: 1. The write cycle time t_{WR} is the time from a valid stop condition of a write sequence to the end of the internal clear/write cycle.

Figure 4-6. Output Acknowledge



5. Device Addressing

The 256K EEPROM requires an 8-bit device address word following a start condition to enable the chip for a read or write operation (see [Figure 5-1](#)). The device address word consists of a mandatory “1”, “0” sequence for the first four most significant bits as shown. This is common to all two-wire EEPROM devices.

Figure 5-1. Device Address

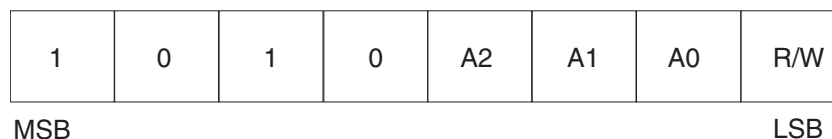

The next three bits are the A2, A1, A0 device address bits to allow as many as eight devices on the same bus. These bits must compare to their corresponding hardwired input pins. The A2, A1, and A0 pins use an internal proprietary circuit that biases them to a logic low condition if the pins are allowed to float.

The eighth bit of the device address is the read/write operation select bit. A read operation is initiated if this bit is high, and a write operation is initiated if this bit is low.

Upon a compare of the device address, the EEPROM will output a “0”. If a compare is not made, the device will return to a standby state.

DATA SECURITY: The AT24C256B has a hardware data protection scheme that allows the user to write protect the whole memory when the WP pin is at V_{CC} .

6. Write Operations

BYTE WRITE: A write operation requires two 8-bit data word addresses following the device address word and acknowledgment. Upon receipt of this address, the EEPROM will again respond with a “0” and then clock in the first 8-bit data word. Following receipt of the 8-bit data word, the EEPROM will output a “0”. The addressing device, such as a microcontroller, must then terminate the write sequence with a stop condition. At this time the EEPROM enters an internally-timed write cycle, t_{WR} , to the nonvolatile memory. All inputs are disabled during this write cycle and the EEPROM will not respond until the write is complete (see Figure 6-1).

Figure 6-1. Byte Write

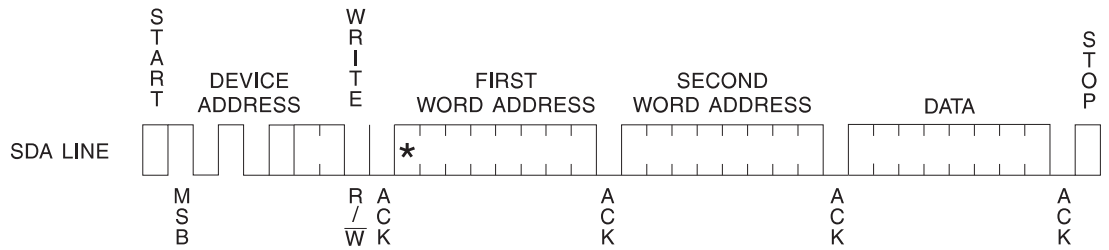

Note: * = DON'T CARE bit

PAGE WRITE: The 256K EEPROM is capable of 64-byte page writes.

A page write is initiated the same way as a byte write, but the microcontroller does not send a stop condition after the first data word is clocked in. Instead, after the EEPROM acknowledges receipt of the first data word, the microcontroller can transmit up to 63 more data words. The EEPROM will respond with a “0” after each data word received. The microcontroller must terminate the page write sequence with a stop condition (see Figure 6-2).

Figure 6-2. Page Write

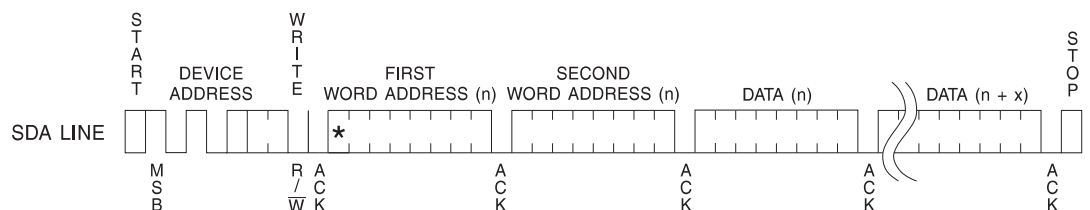

Note: * = DON'T CARE bit

The data word address lower six bits are internally incremented following the receipt of each data word. The higher data word address bits are not incremented, retaining the memory page row location. When the word address, internally generated, reaches the page boundary, the following byte is placed at the beginning of the same page. If more than 64 data words are transmitted to the EEPROM, the data word address will “roll over” and previous data will be overwritten. The address “roll over” during write is from the last byte of the current page to the first byte of the same page.

ACKNOWLEDGE POLLING: Once the internally-timed write cycle has started and the EEPROM inputs are disabled, acknowledge polling can be initiated. This involves sending a start condition followed by the device address word. The read/write bit is representative of the operation desired. Only if the internal write cycle has completed will the EEPROM respond with a “0”, allowing the read or write sequence to continue.

7. Read Operations

Read operations are initiated the same way as write operations with the exception that the read/write select bit in the device address word is set to “1”. There are three read operations: current address read, random address read, and sequential read.

CURRENT ADDRESS READ: The internal data word address counter maintains the last address accessed during the last read or write operation, incremented by one. This address stays valid between operations as long as the chip power is maintained. The address “roll over” during read is from the last byte of the last memory page, to the first byte of the first page.

Once the device address with the read/write select bit set to “1” is clocked in and acknowledged by the EEPROM, the current address data word is serially clocked out. The microcontroller does not respond with an input “0” but does generate a following stop condition (see [Figure 7-1](#)).

Figure 7-1. Current Address Read

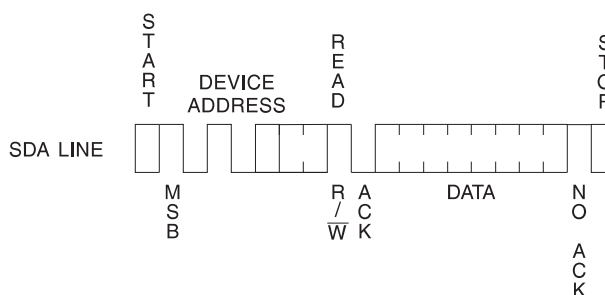

RANDOM READ: A random read requires a “dummy” byte write sequence to load in the data word address. Once the device address word and data word address are clocked in and acknowledged by the EEPROM, the microcontroller must generate another start condition. The microcontroller now initiates a current address read by sending a device address with the read/write select bit high. The EEPROM acknowledges the device address and serially clocks out the data word. The microcontroller does not respond with a “0” but does generate a following stop condition (see [Figure 7-2](#)).

Figure 7-2. Random Read

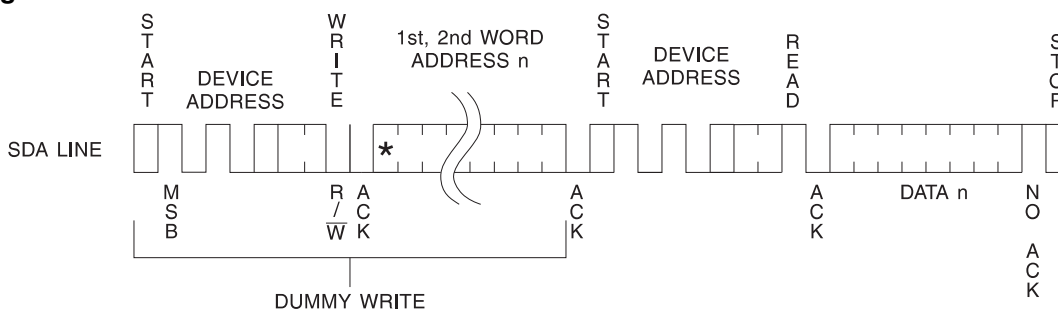

Note: * = DON'T CARE bit

SEQUENTIAL READ: Sequential reads are initiated by either a current address read or a random address read. After the microcontroller receives a data word, it responds with an acknowledge. As long as the EEPROM receives an acknowledge, it will continue to increment the data word address and serially clock out sequential data words. When the memory address limit is reached, the data word address will “roll over” and the sequential read will continue. The sequential read operation is terminated when the microcontroller does not respond with a “0” but does generate a following stop condition (see [Figure 7-3](#)).

Figure 7-3. Sequential Read

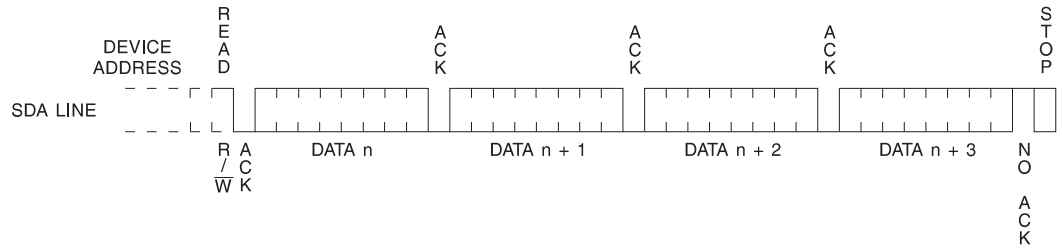

8. AT24C256B Ordering Codes

Ordering Code	Voltage	Package	Operation Range
AT24C256B-PU (Bulk Form Only)	1.8	8P3	Lead-free/Halogen-free Industrial Temperature (-40°C to 85°C)
AT24C256BN-SH-B ⁽¹⁾ (NiPdAu Lead Finish)	1.8	8S1	
AT24C256BN-SH-T ⁽²⁾ (NiPdAu Lead Finish)	1.8	8S1	
AT24C256BW-SH-B ⁽¹⁾ (NiPdAu Lead Finish)	1.8	8S2	
AT24C256BW-SH-T ⁽²⁾ (NiPdAu Lead Finish)	1.8	8S2	
AT24C256B-TH-B ⁽¹⁾ (NiPdAu Lead Finish)	1.8	8A2	
AT24C256B-TH-T ⁽²⁾ (NiPdAu Lead Finish)	1.8	8A2	
AT24C256BY7-YH-T ⁽²⁾ (NiPdAu Lead Finish)	1.8	8Y7	
AT24C256BU2-UU-T ⁽²⁾	1.8	8U2-1	
AT24C256B-W-11	1.8	Die Sale	Industrial Temperature (-40°C to 85°C)

- Notes:
1. “-B” denotes bulk.
 2. “-T” denotes tape and reel. SOIC = 4K per reel. TSSOP and dBGA2 = 5K per reel. SAP = 3K per reel. EIAJ = 2K per reel.
 3. Available in tape & reel and wafer form; order as SL788 for inkless wafer form. Bumped die available upon request. Please contact Serial Interface Marketing.

Package Type	
8P3	8-lead, 0.300" Wide, Plastic Dual Inline Package (PDIP)
8S1	8-lead, 0.150" Wide, Plastic Gull Wing Small Outline Package (JEDEC SOIC)
8S2	8-lead, 0.200" Wide, Plastic Gull Wing Small Outline Package (EIAJ SOIC)
8U2-1	8-ball, die Ball Grid Array Package (dBGA2)
8A2	8-lead, 4.40 mm Body, Plastic Thin Shrink Small Outline Package (TSSOP)
8Y7	8-lead, 6.00 mm x 4.90 mm Body, Ultra Thin, Dual Footprint, Non-leaded, Small Array Package (SAP)
Options	
-1.8	Low-voltage (1.8V to 5.5V)

9. Part Marking Scheme

8-PDIP

TOP MARK

```

                Seal Year
                | Seal Week
                | | |
|---|---|---|---|---|---|---|---|
  A  T  M  L  U  Y  W  W
|---|---|---|---|---|---|---|---|
  2  E  B      1
|---|---|---|---|---|---|---|---|
  *  Lot Number
|---|---|---|---|---|---|---|---|
  |
  Pin 1 Indicator (Dot)

```

Y = SEAL YEAR

```

6: 2006   0: 2010
7: 2007   1: 2011
8: 2008   2: 2012
9: 2009   3: 2013

```

WW = SEAL WEEK

```

02 = Week 2
04 = Week 4
:: : :::: :
:: : :::: ::
50 = Week 50
52 = Week 52

```

Lot Number to Use ALL Characters in Marking

BOTTOM MARK

No Bottom Mark

8-SOIC

TOP MARK

```

                Seal Year
                | Seal Week
                | | |
|---|---|---|---|---|---|---|---|
  A  T  M  L  H  Y  W  W
|---|---|---|---|---|---|---|---|
  2  E  B      1
|---|---|---|---|---|---|---|---|
  *  Lot Number
|---|---|---|---|---|---|---|---|
  |
  Pin 1 Indicator (Dot)

```

Y = SEAL YEAR

```

6: 2006   0: 2010
7: 2007   1: 2011
8: 2008   2: 2012
9: 2009   3: 2013

```

WW = SEAL WEEK

```

02 = Week 2
04 = Week 4
:: : :::: :
:: : :::: ::
50 = Week 50
52 = Week 52

```

Lot Number to Use ALL Characters in Marking

BOTTOM MARK

No Bottom Mark

8-TSSOP

TOP MARK

```

Pin 1 Indicator (Dot)
|
|---|---|---|---|
*  H  Y  W  W
|---|---|---|---|
  2  E  B      1
|---|---|---|---|
    
```

Y = SEAL YEAR

6:	2006	0:	2010
7:	2007	1:	2011
8:	2008	2:	2012
9:	2009	3:	2013

WW = SEAL WEEK

02	=	Week 2
04	=	Week 4
::	:	:::: :
::	:	:::: ::
50	=	Week 50
52	=	Week 52

BOTTOM MARK

```

|---|---|---|---|---|---|
X  X
|---|---|---|---|---|---|
A  A  A  A  A  A  A
|---|---|---|---|---|---|
<- Pin 1 Indicator
    
```

XX = Country of Origin

8-Ultra Thin SAP

TOP MARK

```

Seal Year
| Seal Week
| | |
|---|---|---|---|---|---|---|---|
A  T  M  L  H  Y  W  W
|---|---|---|---|---|---|---|---|
  2  E  B      1
|---|---|---|---|---|---|---|---|
Lot Number
|---|---|---|---|---|---|---|---|
*
|
Pin 1 Indicator (Dot)
    
```

Y = SEAL YEAR

6:	2006	0:	2010
7:	2007	1:	2011
8:	2008	2:	2012
9:	2009	3:	2013

WW = SEAL WEEK

02	=	Week 2
04	=	Week 4
::	:	:::: :
::	:	:::: ::
50	=	Week 50
52	=	Week 52



dBGA2

TOP MARK

```
LINE 1----->    2EBU
LINE 2----->    YMTC
                  |<-- Pin 1 This Corner
```

Y = ONE DIGIT YEAR CODE

4: 2004 7: 2007

5: 2005 8: 2008

6: 2006 9: 2009

M = SEAL MONTH (USE ALPHA DESIGNATOR A-L)

A = JANUARY

B = FEBRUARY

" " " " " " " " " " " "

J = OCTOBER

K = NOVEMBER

L = DECEMBER

TC = TRACE CODE



10. Packaging Information

8P3 – PDIP

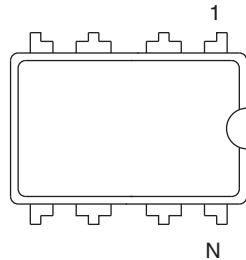

Top View

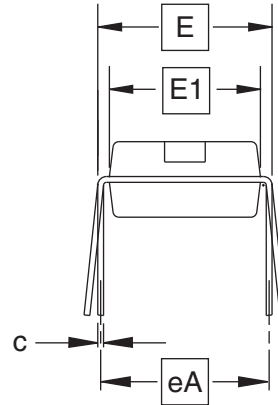

End View

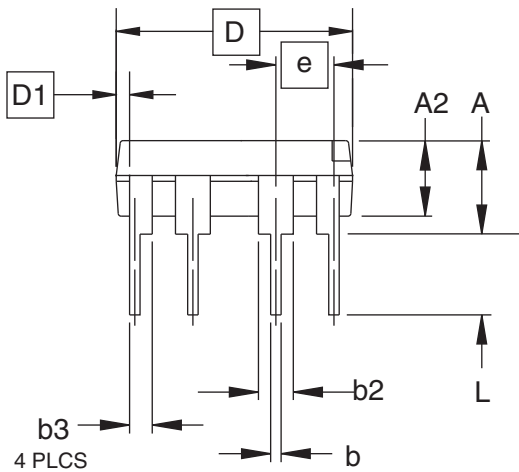

Side View

COMMON DIMENSIONS
(Unit of Measure = inches)

SYMBOL	MIN	NOM	MAX	NOTE
A	–	–	0.210	2
A2	0.115	0.130	0.195	
b	0.014	0.018	0.022	5
b2	0.045	0.060	0.070	6
b3	0.030	0.039	0.045	6
c	0.008	0.010	0.014	
D	0.355	0.365	0.400	3
D1	0.005	–	–	3
E	0.300	0.310	0.325	4
E1	0.240	0.250	0.280	3
e	0.100 BSC			
eA	0.300 BSC			4
L	0.115	0.130	0.150	2

- Notes:
1. This drawing is for general information only; refer to JEDEC Drawing MS-001, Variation BA, for additional information.
 2. Dimensions A and L are measured with the package seated in JEDEC seating plane Gauge GS-3.
 3. D, D1 and E1 dimensions do not include mold Flash or protrusions. Mold Flash or protrusions shall not exceed 0.010 inch.
 4. E and eA measured with the leads constrained to be perpendicular to datum.
 5. Pointed or rounded lead tips are preferred to ease insertion.
 6. b2 and b3 maximum dimensions do not include Dambar protrusions. Dambar protrusions shall not exceed 0.010 (0.25 mm).

01/09/02



2325 Orchard Parkway
San Jose, CA 95131

TITLE
8P3, 8-lead, 0.300" Wide Body, Plastic Dual
In-line Package (PDIP)

DRAWING NO.
8P3

REV.
B



8S1 – JEDEC SOIC

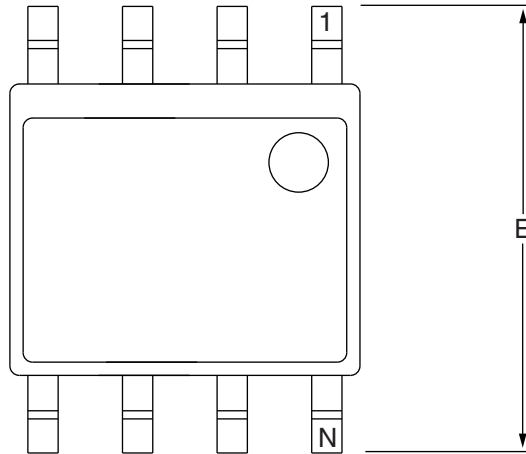

Top View

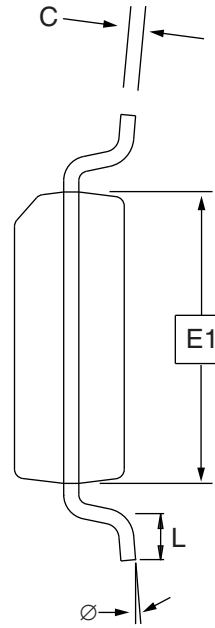

End View

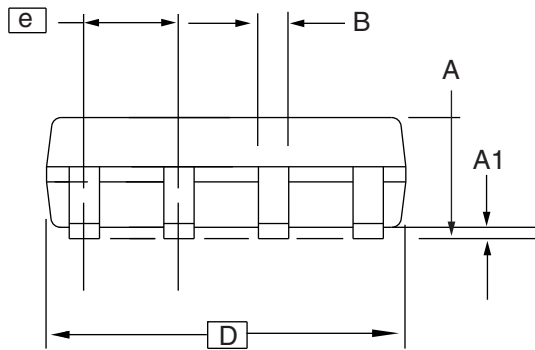

Side View

COMMON DIMENSIONS
(Unit of Measure = mm)

SYMBOL	MIN	NOM	MAX	NOTE
A	1.35	–	1.75	
A1	0.10	–	0.25	
b	0.31	–	0.51	
C	0.17	–	0.25	
D	4.80	–	5.00	
E1	3.81	–	3.99	
E	5.79	–	6.20	
e	1.27 BSC			
L	0.40	–	1.27	
∅	0°	–	8°	

Note: These drawings are for general information only. Refer to JEDEC Drawing MS-012, Variation AA for proper dimensions, tolerances, datums, etc.

10/7/03



1150 E. Cheyenne Mtn. Blvd.
Colorado Springs, CO 80906

TITLE
8S1, 8-lead (0.150" Wide Body), Plastic Gull Wing
Small Outline (JEDEC SOIC)

DRAWING NO.
8S1

REV.
B

8S2 - EIAJ SOIC

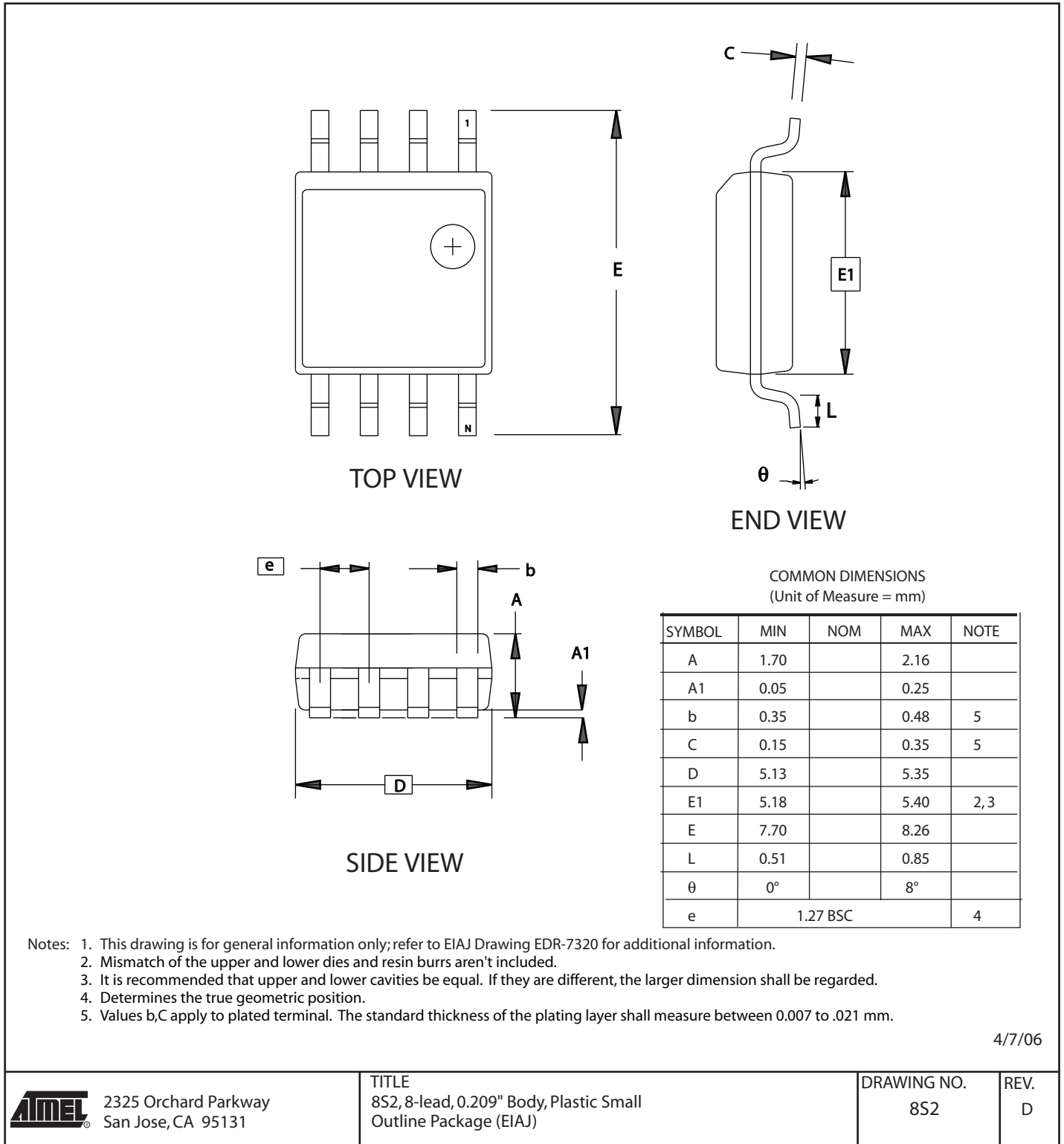

8U2-1 – dBGA2

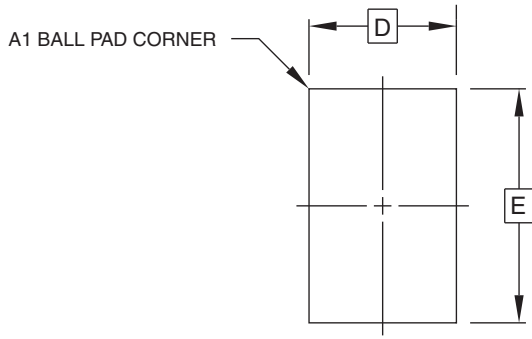

Top View

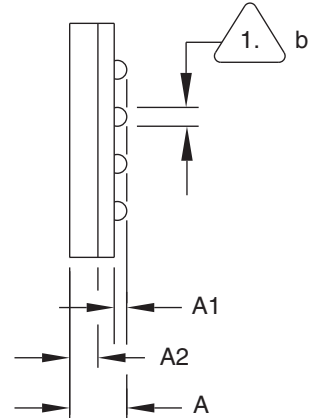

Side View

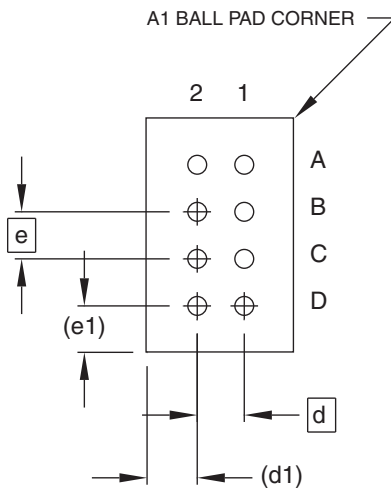

Bottom View
8 Solder Balls

COMMON DIMENSIONS
(Unit of Measure = mm)

SYMBOL	MIN	NOM	MAX	NOTE
A	0.81	0.91	1.00	
A1	0.15	0.20	0.25	
A2	0.40	0.45	0.50	
b	0.25	0.30	0.35	1
D	2.35 BSC			
E	3.73 BSC			
e	0.75 BSC			
e1	0.74 REF			
d	0.75 BSC			
d1	0.80 REF			

1. Dimension 'b' is measured at the maximum solder ball diameter.

This drawing is for general information only.

6/24/03



1150 E. Cheyenne Mtn. Blvd.
Colorado Springs, CO 80906

TITLE

8U2-1, 8-ball, 2.35 x 3.73 mm Body, 0.75 mm pitch,
Small Die Ball Grid Array Package (dBGA2)

DRAWING NO.

PO8U2-1

REV.

A

8A2 – TSSOP

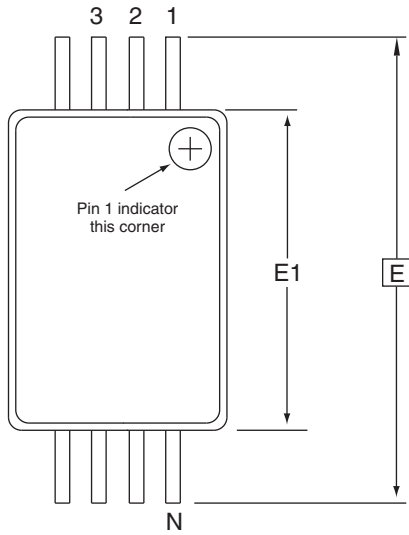

Top View

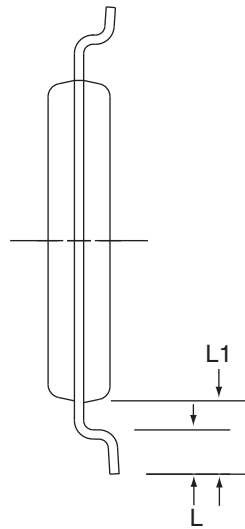

End View

COMMON DIMENSIONS
(Unit of Measure = mm)

SYMBOL	MIN	NOM	MAX	NOTE
D	2.90	3.00	3.10	2, 5
E	6.40 BSC			
E1	4.30	4.40	4.50	3, 5
A	-	-	1.20	
A2	0.80	1.00	1.05	
b	0.19	-	0.30	4
e	0.65 BSC			
L	0.45	0.60	0.75	
L1	1.00 REF			

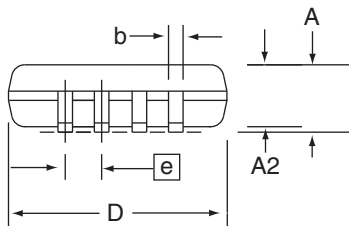

Side View

- Notes:
1. This drawing is for general information only. Refer to JEDEC Drawing MO-153, Variation AA, for proper dimensions, tolerances, datums, etc.
 2. Dimension D does not include mold Flash, protrusions or gate burrs. Mold Flash, protrusions and gate burrs shall not exceed 0.15 mm (0.006 in) per side.
 3. Dimension E1 does not include inter-lead Flash or protrusions. Inter-lead Flash and protrusions shall not exceed 0.25 mm (0.010 in) per side.
 4. Dimension b does not include Dambar protrusion. Allowable Dambar protrusion shall be 0.08 mm total in excess of the b dimension at maximum material condition. Dambar cannot be located on the lower radius of the foot. Minimum space between protrusion and adjacent lead is 0.07 mm.
 5. Dimension D and E1 to be determined at Datum Plane H.

5/30/02

ATMEL 2325 Orchard Parkway
San Jose, CA 95131

TITLE
8A2, 8-lead, 4.4 mm Body, Plastic
Thin Shrink Small Outline Package (TSSOP)

DRAWING NO.
8A2

REV.
B

8Y7 – SAP

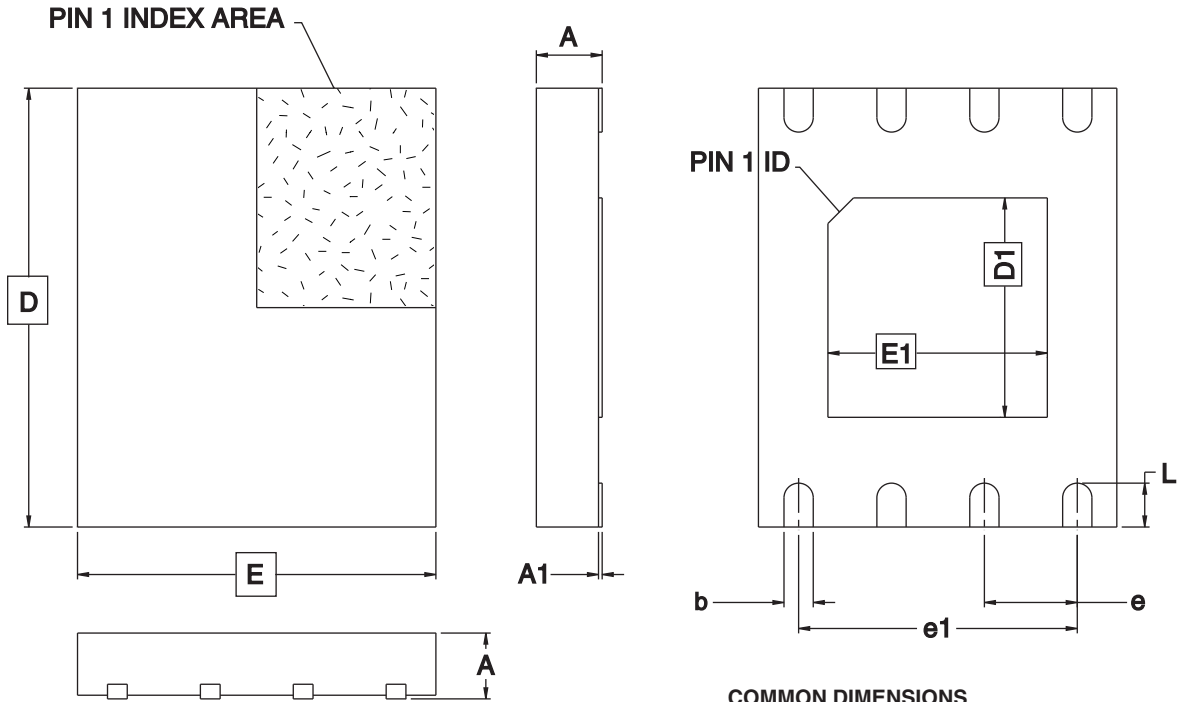

COMMON DIMENSIONS
(Unit of Measure = mm)

SYMBOL	MIN	NOM	MAX	NOTE
A	–	–	0.60	
A1	0.00	–	0.05	
D	5.80	6.00	6.20	
E	4.70	4.90	5.10	
D1	3.30	3.40	3.50	
E1	3.90	4.00	4.10	
b	0.35	0.40	0.45	
e	1.27 TYP			
e1	3.81 REF			
L	0.50	0.60	0.70	

10/13/05



1150 E. Cheyenne Mtn. Blvd.
Colorado Springs, CO 80906

TITLE

8Y7, 8-lead (6.00 x 4.90 mm Body) Ultra-Thin SOIC Array Package (UTSAP) Y7

DRAWING NO.

8Y7

REV.

B

Revision History

Doc. Rev.	Date	Comments
5279C	3/2009	Changed the Vcc to 5.5V in the test condition for Isb1
5279B	3/2008	Format changes to document
5279A	1/2008	AT24C256B product with date code 2008 work week 14 (814) or later supports 5Vcc operation Initial document release



Headquarters

Atmel Corporation
2325 Orchard Parkway
San Jose, CA 95131
USA
Tel: 1(408) 441-0311
Fax: 1(408) 487-2600

International

Atmel Asia
Room 1219
Chinachem Golden Plaza
77 Mody Road Tsimshatsui
East Kowloon
Hong Kong
Tel: (852) 2721-9778
Fax: (852) 2722-1369

Atmel Europe
Le Krebs
8, Rue Jean-Pierre Timbaud
BP 309
78054 Saint-Quentin-en-
Yvelines Cedex
France
Tel: (33) 1-30-60-70-00
Fax: (33) 1-30-60-71-11

Atmel Japan
9F, Tonetsu Shinkawa Bldg.
1-24-8 Shinkawa
Chuo-ku, Tokyo 104-0033
Japan
Tel: (81) 3-3523-3551
Fax: (81) 3-3523-7581

Product Contact

Web Site
www.atmel.com

Technical Support
s_eeeprom@atmel.com

Sales Contact
www.atmel.com/contacts

Literature Requests
www.atmel.com/literature

Disclaimer: The information in this document is provided in connection with Atmel products. No license, express or implied, by estoppel or otherwise, to any intellectual property right is granted by this document or in connection with the sale of Atmel products. **EXCEPT AS SET FORTH IN ATMEL'S TERMS AND CONDITIONS OF SALE LOCATED ON ATMEL'S WEB SITE, ATMEL ASSUMES NO LIABILITY WHATSOEVER AND DISCLAIMS ANY EXPRESS, IMPLIED OR STATUTORY WARRANTY RELATING TO ITS PRODUCTS INCLUDING, BUT NOT LIMITED TO, THE IMPLIED WARRANTY OF MERCHANTABILITY, FITNESS FOR A PARTICULAR PURPOSE, OR NON-INFRINGEMENT. IN NO EVENT SHALL ATMEL BE LIABLE FOR ANY DIRECT, INDIRECT, CONSEQUENTIAL, PUNITIVE, SPECIAL OR INCIDENTAL DAMAGES (INCLUDING, WITHOUT LIMITATION, DAMAGES FOR LOSS OF PROFITS, BUSINESS INTERRUPTION, OR LOSS OF INFORMATION) ARISING OUT OF THE USE OR INABILITY TO USE THIS DOCUMENT, EVEN IF ATMEL HAS BEEN ADVISED OF THE POSSIBILITY OF SUCH DAMAGES.** Atmel makes no representations or warranties with respect to the accuracy or completeness of the contents of this document and reserves the right to make changes to specifications and product descriptions at any time without notice. Atmel does not make any commitment to update the information contained herein. Unless specifically provided otherwise, Atmel products are not suitable for, and shall not be used in, automotive applications. Atmel's products are not intended, authorized, or warranted for use as components in applications intended to support or sustain life.

© 2009 Atmel Corporation. All rights reserved. Atmel®, Atmel logo and combinations thereof, and others, are registered trademarks or trademarks of Atmel Corporation or its subsidiaries. Other terms and product names may be trademarks of others.

Mouser Electronics

Authorized Distributor

Click to View Pricing, Inventory, Delivery & Lifecycle Information:

[Microchip:](#)

[AT24C256B-PU](#) [AT24C256B-TH-B](#)