

μPC251 / 1458

Dual General Purpose Operational Amplifiers

GENERAL DESCRIPTION

The μPC251 and 1458 are dual general purpose operational amplifiers having internal frequency compensating circuits. It is intended for a wide range of analog applications. High common mode voltage range and no latch up tendencies make this amplifier ideal for use as a voltage follower.

Two kinds of ICs are available according to reliability, the μPC251 for industry, the μPC1458 for commercial.

FEATURES

- Dual μPC151/741 Internally Frequency Compensated Operational Amplifier
- Short Circuit Protection
- Large Common Mode and Differential Input Voltage
- No Latch Up
- MC1458 Direct Replacement

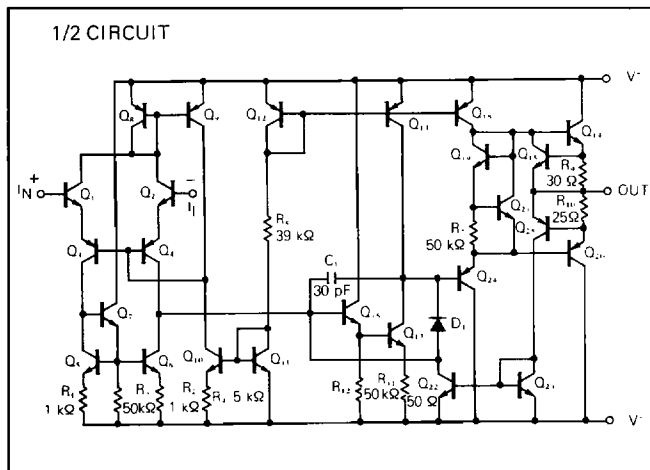

EQUIVALENT CIRCUIT

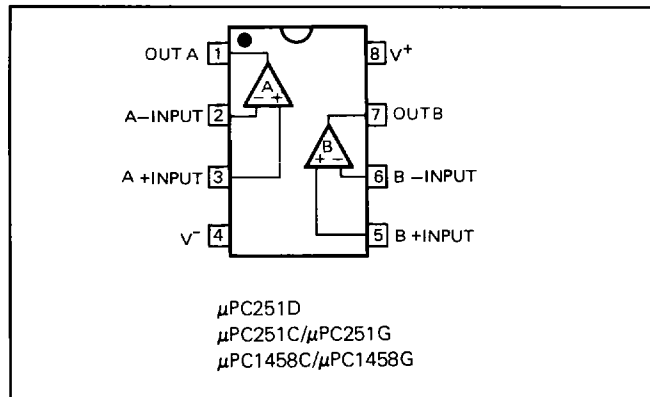

CONNECTION DIAGRAM (Top View)



ORDERING INFORMATION

μPC251D  8 pin Ceramic DIP (Dual In-Line Package)
μPC251C/μPC1458C  8 pin Plastic Molded DIP (Dual In-Line Package)
μPC251G/μPC1458G  8 pin Plastic Molded Flat Package (MINI FLAT IC)

ABSOLUTE MAXIMUM RATINGS (Ta = 25°C)

PARAMETER		μPC251	μPC1458	UNIT
Voltage between V ⁺ and V ⁻		36	36	V
Power Dissipation*	D Package	500	—	mW
	C Package	350	350	
	G Package	440	440	
Differential Input Voltage		±30	±30	V
Input Voltage (Note 1)		±15	±15	V
Output Short Circuit Duration		Indefinite	Indefinite	s
Operating Temperature Range	D Package	-20 to +80	—	°C
	C or G Package	-20 to +70	0 to +70	
Storage Temperature Range	D Package	-55 to +150	—	°C
	C or G Package	-55 to +125	-55 to +125	

Note 1: For supply voltages less than ±15 V, the absolute maximum input voltage is equal to the supply voltage.

* See thermal information in chapter 11.

ELECTRICAL CHARACTERISTICS (V[±] = ±15 V, Ta = 25°C)

CHARACTERISTIC	MIN.	TYP.	MAX.	UNIT	CONDITIONS
Input Offset Voltage		1.0	6.0	mV	R _s ≤ 10 kΩ
Average Input Offset Voltage Drift		3		μV/°C	R _s ≤ 10 kΩ
Input Offset Current		20	200	nA	
Input Bias Current		80	500	nA	
Large Signal Voltage Gain	20,000	160,000			R _L ≥ 2 kΩ, V _o = ±10 V
Channel Separation		120		dB	f = 10 Hz, R _L = 2 kΩ
Supply Current		3.0	5.6	mA	
Power Consumption		90	170	mW	
Common Mode Rejection Ratio	70	90		dB	R _s ≤ 10 kΩ
Supply Voltage Rejection Ratio		30	150	μV/V	R _s ≤ 10 kΩ
Output Voltage Swing	±12	±14		V	R _L ≥ 10 kΩ
Output Voltage Swing	±10	±13		V	R _L ≥ 2 kΩ
Input Impedance	0.3	1.0		MΩ	

TYPICAL PERFORMANCE CHARACTERISTICS ($T_a=25^\circ\text{C}$)

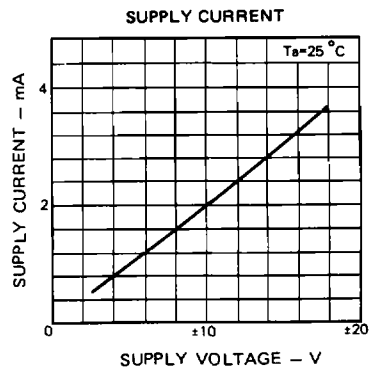
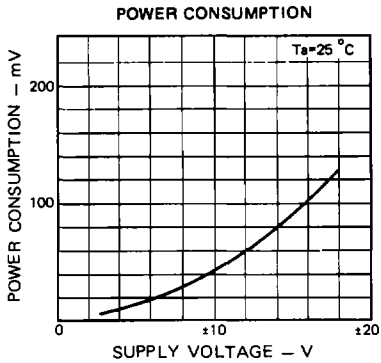
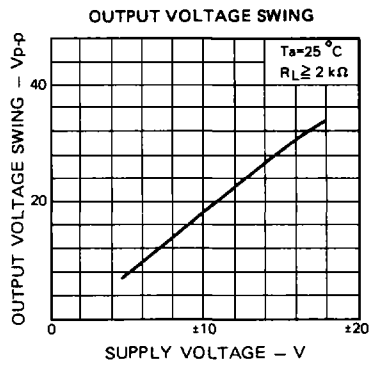
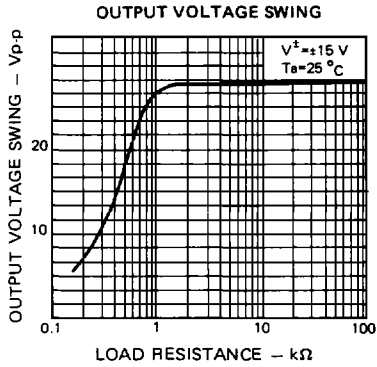
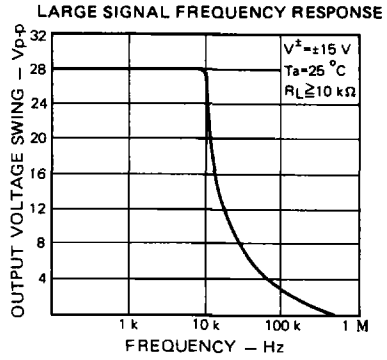
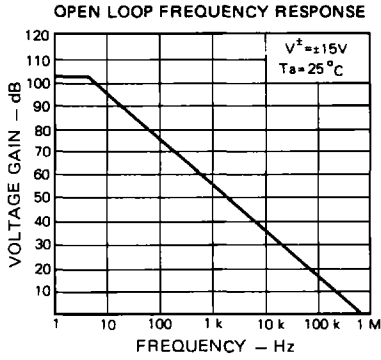

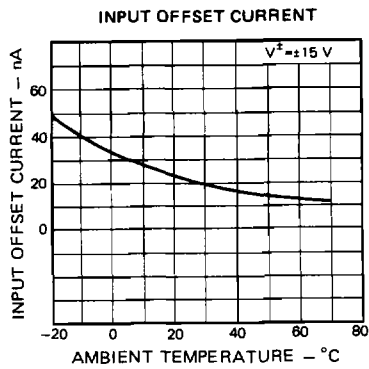
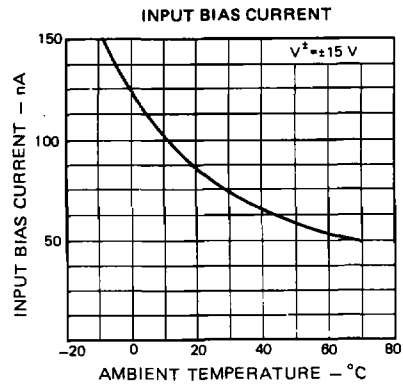
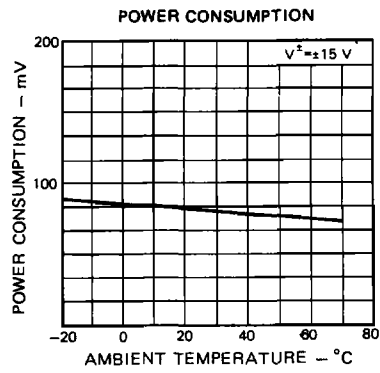
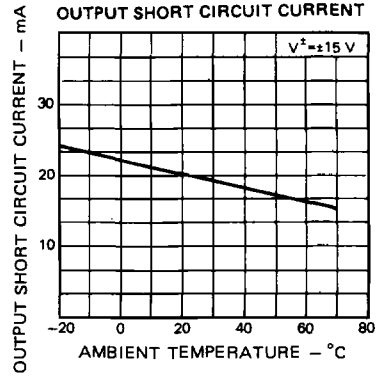
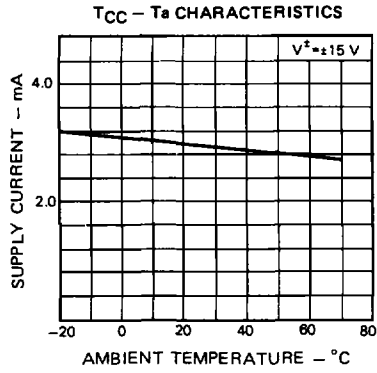

5