

## SEMİTRANS® M Power MOSFET Modules SKM 214 A

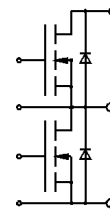

### SEMİTRANS 2



#### Features

- N Channel, enhancement mode
- Avalanche characteristic
- Short internal connections avoid oscillations
- Isolated copper baseplate
- All electrical connections on top for easy busbaring
- Large clearances (10 mm) and creepage distances (20 mm)
- UL recognized, file no. E 63 532

#### Typical Applications

- Switched mode power supplies
- DC servo and robot drives
- DC choppers
- UPS equipment
- Not suitable for linear amplification

**This is an electrostatic discharge sensitive device (ESDS). Please observe the international standard IEC 747-1, Chapter IX.**

Absolute Maximum Ratings			
Symbol	Conditions <sup>1)</sup>	Values	Units
V <sub>DS</sub>		100	V
V <sub>DGR</sub>	R <sub>GS</sub> = 20 kΩ	100	V
I <sub>D</sub>		125	A
I <sub>DM</sub>		375	A
V <sub>GS</sub>		± 20	V
P <sub>D</sub>		400	W
T <sub>j</sub> , (T <sub>stg</sub> )		- 40 ... +150 (125)	°C
V <sub>isol</sub>	AC, 1 min	2 500	V
humidity	DIN 40 040	Class F	
climate	DIN IEC 68 T.1	40/125/56	
Inverse Diode			
I <sub>F</sub> = - I <sub>D</sub>		125	A
I <sub>FM</sub> = - I <sub>DM</sub>		375	A

Characteristics					
Symbol	Conditions <sup>1)</sup>	min.	typ.	max.	Units
V <sub>(BR)DSS</sub>	V <sub>GS</sub> = 0, I <sub>D</sub> = 0,25 mA	100	-	-	V
V <sub>GS(th)</sub>	V <sub>GS</sub> = V <sub>DS</sub> , I <sub>D</sub> = 1 mA	2,1	3,0	4,0	V
I <sub>DSS</sub>	V <sub>GS</sub> = 0, } T <sub>j</sub> = 25 °C	-	50	250	μA
		V <sub>DS</sub> = 100 V } T <sub>j</sub> = 125 °C	-	300	1000
I <sub>GSS</sub>	V <sub>GS</sub> = 20 V, V <sub>DS</sub> = 0		-	10	100
R <sub>DS(on)</sub>	V <sub>GS</sub> = 10 V, I <sub>D</sub> = 78 A	-	10	13	mΩ
g <sub>fs</sub>	V <sub>DS</sub> = 25 V, I <sub>D</sub> = 78 A	40	60	-	S
C <sub>CHC</sub>	per MOSFET	-	-	100	pF
C <sub>iss</sub>	V <sub>GS</sub> = 0 } V <sub>DS</sub> = 25 V } f = 1 MHz	-	9	12	nF
C <sub>oss</sub>		-	4	6	nF
C <sub>rss</sub>		-	1,6	2,4	nF
L <sub>DS</sub>		-	-	20	nH
t <sub>d(on)</sub>	V <sub>DD</sub> = 50 V } I <sub>D</sub> = 78 A	-	50	-	ns
t <sub>r</sub>		-	190	-	ns
t <sub>d(off)</sub>	V <sub>GS</sub> = 10 V } R <sub>GS</sub> = 3,3 Ω	-	190	-	ns
t <sub>f</sub>		-	50	-	ns
Inverse Diode					
V <sub>SD</sub>	I <sub>F</sub> = 250 A, V <sub>GS</sub> = 0	-	1,25	1,6	V
t <sub>rr</sub>	T <sub>j</sub> = 25 °C <sup>2)</sup>	-	320	-	ns
	T <sub>j</sub> = 150 °C <sup>2)</sup>	-	-	-	ns
Q <sub>rr</sub>	T <sub>j</sub> = 25 °C <sup>2)</sup>	-	3,6	-	μC
	T <sub>j</sub> = 150 °C <sup>2)</sup>	-	-	-	
Thermal Characteristics					
R <sub>thjc</sub>	per MOSFET	-	-	0,31	°C/W
R <sub>thch</sub>	per module	-	-	0,07	°C/W

Mechanical Data					
M <sub>1</sub>	to heatsink, SI Units	4	-	5	Nm
	to heatsink, US Units	35	-	44	lb.in.
M <sub>2</sub>	for terminals, SI Units	2,5	-	3,5	Nm
	for terminals, US Units	22	-	24	lb.in.
a		-	-	5x9,81	m/s <sup>2</sup>
w		-	-	160	g
Case	→ page B 5 - 2	D 70			

<sup>1)</sup> T<sub>case</sub> = 25 °C, unless otherwise specified.

<sup>2)</sup> I<sub>F</sub> = - I<sub>D</sub>, V<sub>R</sub> = 100 V, - di<sub>F</sub>/dt = 100 A/μs

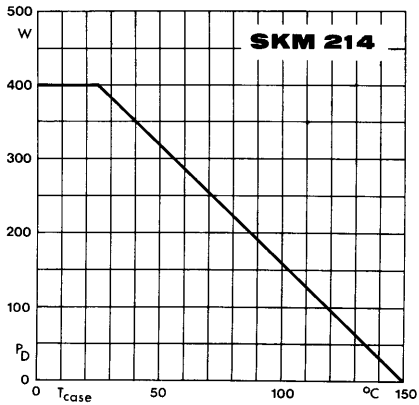

Fig. 1 Rated power dissipation vs. temperature

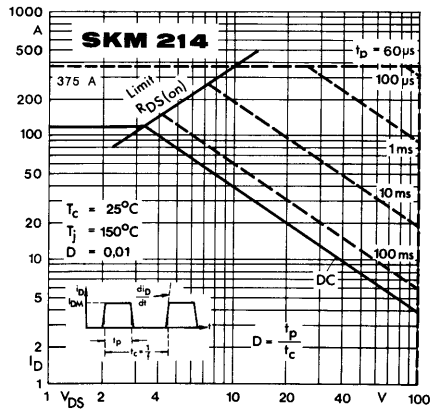

Fig. 2 Maximum safe operating area

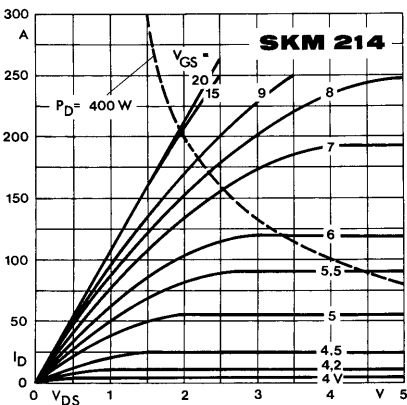

Fig. 3 Output characteristic

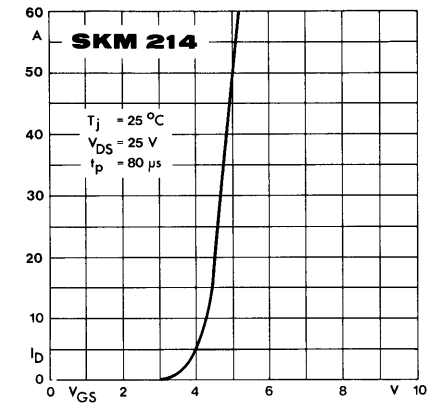

Fig. 4 Transfer characteristic

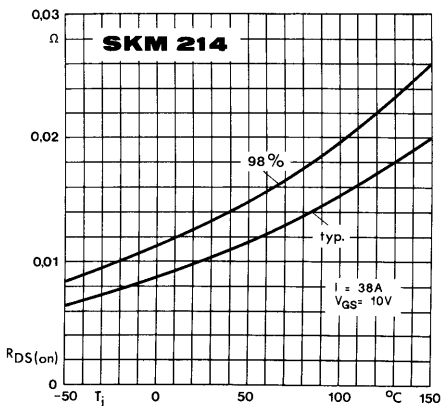

Fig. 5 On-resistance vs. temperature

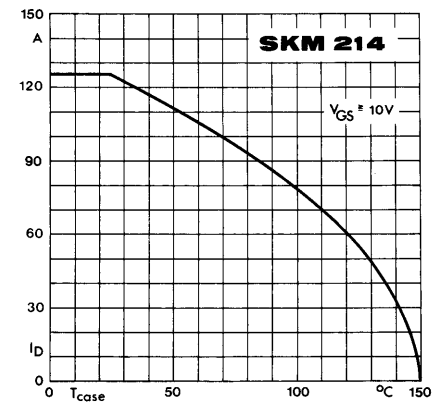

Fig. 6 Rated current vs. temperature

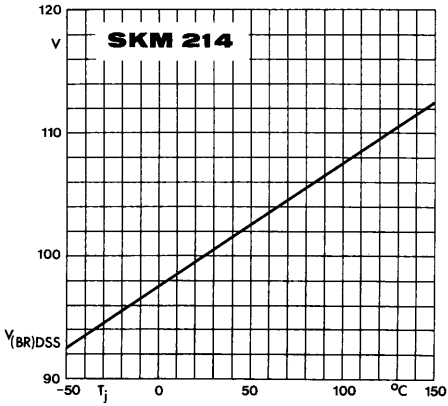

Fig. 7 Breakdown voltage vs. temperature

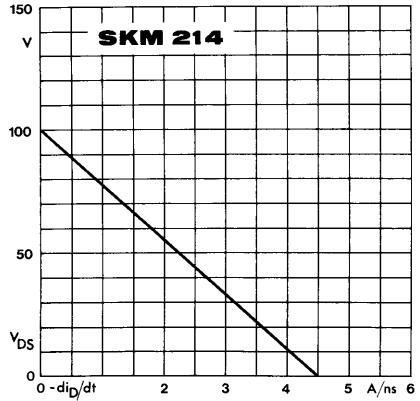

Fig. 8 Drain-source voltage derating

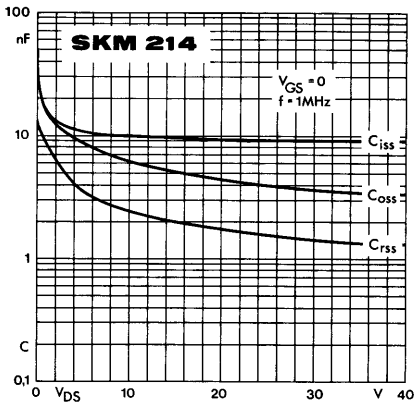

Fig. 9 Capacitances vs. drain-source voltage

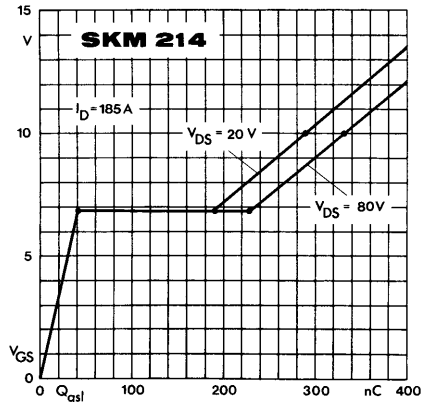

Fig. 10 Gate charge characteristic

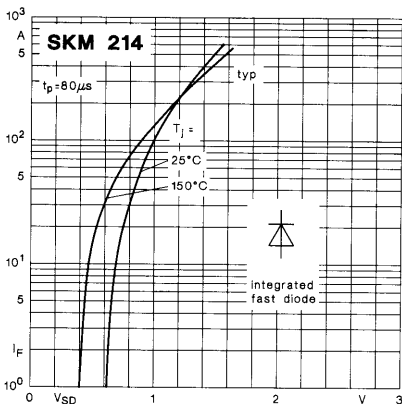

Fig. 11 Diode forward characteristic

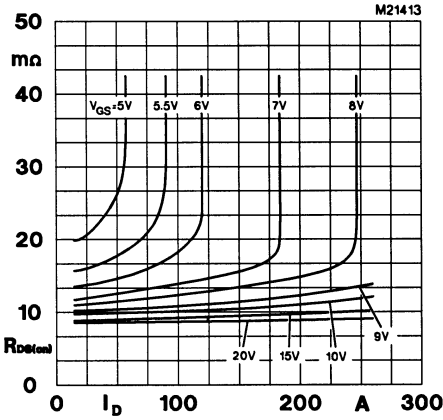

Fig. 13 On-resistance vs. drain current

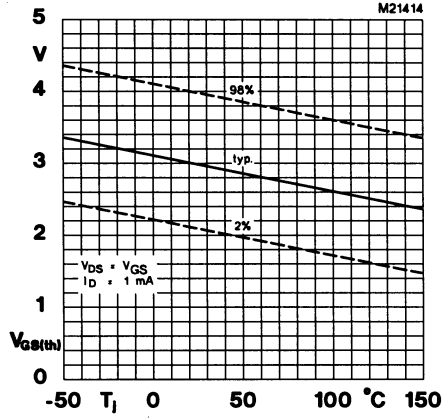

Fig. 14 Gate-source threshold voltage

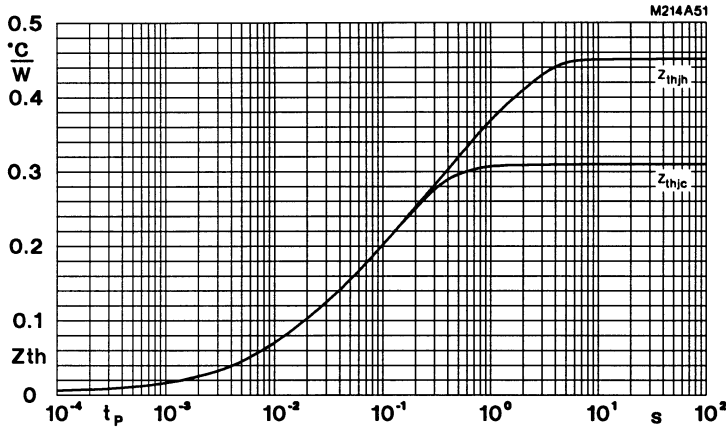

Fig. 51 Transient thermal impedance

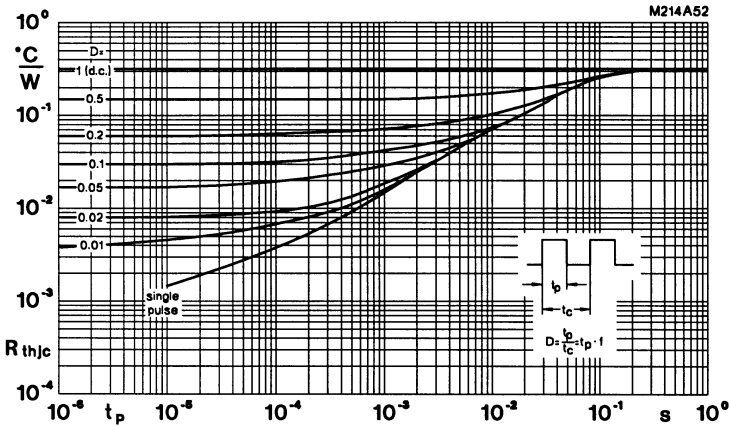
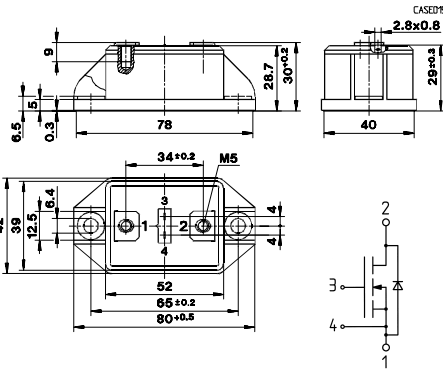

Fig. 52 Thermal impedance under pulse conditions

**SEMISTRANS® M1**

Case D 15  
 SKM 111 AR  
 SKM 121 AR  
 SKM 151 AR  
 SKM 180 A 020  
 SKM 181 A3 (R)

UL recognized  
 File No. E 63 532



Dimensions in mm

w = 130 g

**SEMISTRANS® M2**

Case D 70  
 SKM 120 B 020  
 SKM 204 A  
 SKM 214 A

UL recognized  
 File No. E 63 532

CASED70

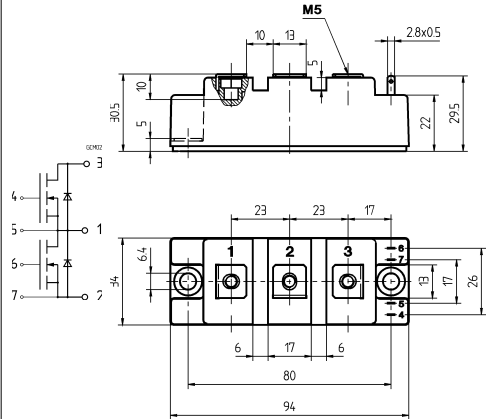

Dimensions in mm

w = 160 g

**SEMISTRANS® M3**

(SINGLE)  
 Case D 71  
 SKM 453 A 020

UL recognized  
 File No. E 63 532

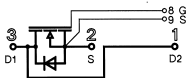

CASED71

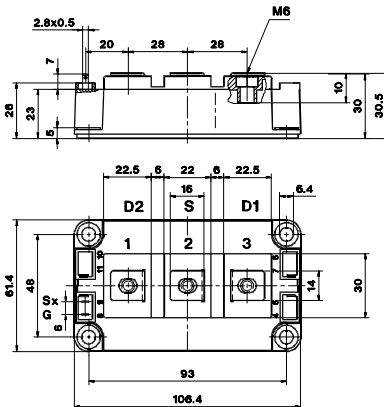

→ B 5 – 18

Dimensions in mm

w = 325 g

**SEMISTRANS® 3**

(DUAL)  
 Case D 56  
 SKM 253 B 020  
 SKM 313 B 010

UL recognized  
 File No. E 63 532

CASED56

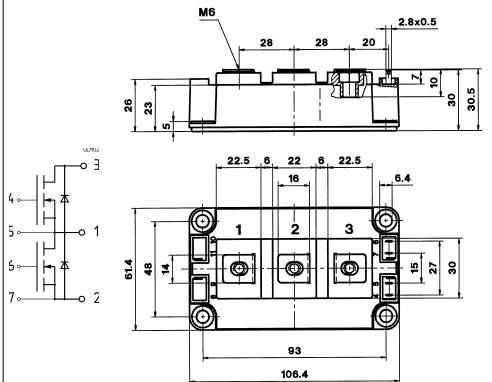

Dimensions in mm

w = 325 g