

173010335, 173010535

## MagI<sup>3</sup>C Power Module

### FDSM – Fixed Step Down Regulator Module



6V – 36V / 1A / 3.3V or 5V Output

#### DESCRIPTION

The FDSM series of the MagI<sup>3</sup>C Power Module family is a fixed output voltage, fully integrated DC-DC power supply including the switching regulator, inductor and capacitors all in one package.

The module requires only an input capacitor and no other external components for operation, reducing design effort and complexity to a minimum.

The FDSM ensures fast time to market and low development costs.

It is pin compatible with the common 78xx linear regulator series. The high efficiency reduces the power dissipation and in many cases a heatsink and assembly parts are unnecessary.

12V to 3.3V conversion achieves up to 87% efficiency.  
12V to 5V conversion achieves up to 92% efficiency.

The standard THT (10.4 x 11.6 x 8mm) package allows for easy assembly.

#### FEATURES

- Peak efficiency up to 94%
- Current capability up to 1A
- Input voltage range: 6V to 36V
- Output voltage: 3.3V or 5V
- Output voltage accuracy:  $\pm 4\%$  max
- No minimum load required
- Partially integrated input and output capacitors
- Integrated inductor
- Low output voltage ripple ( $< 20\text{mV}_{pp}$ )
- Fixed 520kHz switching frequency
- Current mode control
- Pulse skipping for high efficiency at light loads
- Internal soft-start
- Thermal shutdown
- Short circuit protection
- Cycle by cycle current limit
- Pin compatible with the FDSM power modules series
- Operating ambient temperature range: 40°C to 85°C
- RoHS & REACH compliant
- Case and potting material UL 94 Class V0 (flammability testing) certified
- Complies with EN55032 class B conducted and radiated emissions standard

#### TYPICAL APPLICATIONS

- Point-of-Load DC-DC applications from 9V, 12V, 15V, 18V and 24V industrial rails
- Replacement for linear regulator
- Interface and microcontroller supply
- General purpose

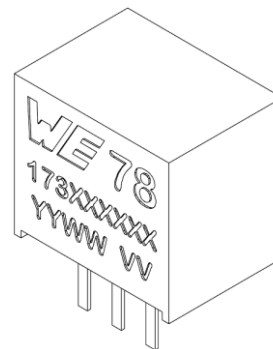

#### TYPICAL CIRCUIT DIAGRAM

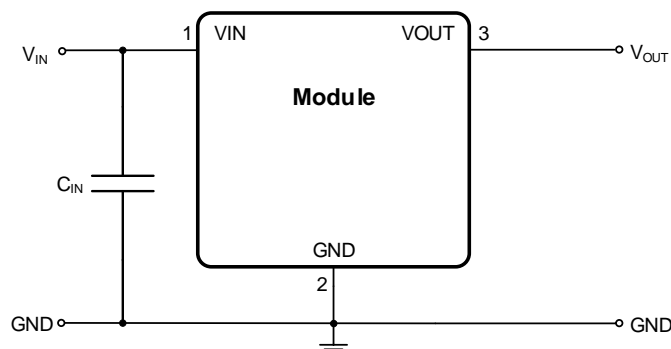

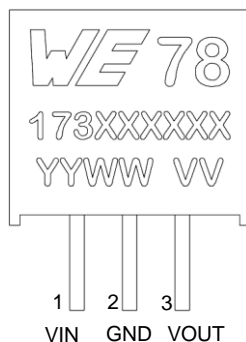
**173010335, 173010535****MagI<sup>3</sup>C** Power Module  
**FDSM** – Fixed Step Down Regulator Module**PACKAGE****MARKING DESCRIPTION**

MARKING	DESCRIPTION
WE	Würth Elektronik tradename
78	Indicates the compatibility with 78xx linear regulator
173010X35	Order code
YY	Year
WW	Calendar week
VV	Output voltage (3.3V or 5V)

**PIN DESCRIPTION**

SYMBOL	PIN	TYPE	DESCRIPTION
VIN	1	Power	The supply input pin is a terminal for an unregulated input voltage source. It is recommended to use a 10 $\mu$ F/50V input capacitor.
GND	2	Power	Ground reference for VIN and VOUT
VOUT	3	Power	Regulated output voltage. There is no need for an external output capacitor.

**ORDERING INFORMATION**

ORDER CODE	SPECIFICATIONS	PACKAGE	PACKAGING UNIT
173010335	36V / 1A / 3.3Vout version	SIP-3	Tube with 43 pieces
173010535	36V / 1A / 5Vout version	SIP-3	Tube with 43 pieces
17800FDSM	4.75 to 42VIN / 3.3 & 5VOUT	Eval Board	1

173010335, 173010535

**MagI<sup>3</sup>C** Power Module  
**FDSM** – Fixed Step Down Regulator Module



#### PIN COMPATIBLE FAMILY MEMBERS

ORDER CODE	SPECIFICATIONS	PACKAGE	PACKAGING UNIT
173950378	28V / 500mA / 3.3Vout version	SIP-3	Tube with 42 pieces
173950578	28V / 500mA / 5Vout version	SIP-3	Tube with 42 pieces
173010378	28V / 1A / 3.3Vout version	SIP-3	Tube with 42 pieces
173010578	28V / 1A / 5Vout version	SIP-3	Tube with 42 pieces
173010342	42V / 1A / 3.3Vout version	SIP-3	Tube with 42 pieces
173010542	42V / 1A / 5Vout version	SIP-3	Tube with 42 pieces
173950336	36V / 500mA / 3.3Vout version	SIP-3	Tube with 43 pieces
173950536	36V / 500mA / 5Vout version	SIP-3	Tube with 43 pieces
173010336	36V / 1A / 3.3Vout version	SIP-3	Tube with 44 pieces
173010536	36V / 1A / 5Vout version	SIP-3	Tube with 44 pieces

#### SALES INFORMATION

SALES CONTACTS
<p>Würth Elektronik eiSos GmbH &amp; Co. KG            EMC &amp; Inductive Solutions            Max-Eyth-Str. 1            74638 Waldenburg            Germany            Tel. +49 (0) 7942 945 0  <a href="http://www.we-online.com/powermodules">www.we-online.com/powermodules</a>            Technical support: <a href="mailto:powermodules@we-online.com">powermodules@we-online.com</a></p>

173010335, 173010535

**MagI<sup>3</sup>C** Power Module  
**FDSM** – Fixed Step Down Regulator Module



## ABSOLUTE MAXIMUM RATINGS

Caution:

Exceeding the listed absolute maximum ratings may affect the device negatively and may cause permanent damage. These are stress ratings only, which do not imply functional operation of the device at these or any other condition beyond those indicated under "Operation Conditions".

SYMBOL	PARAMETER	LIMITS		UNIT
		MIN <sup>(1)</sup>	MAX <sup>(1)</sup>	
V <sub>IN</sub>	Input pin voltage	-0.3	44	V
V <sub>OUT</sub>	Output pin voltage	-0.3	44	V
T <sub>storage</sub>	Assembled, non-operating storage temperature	-55	125	°C
V <sub>ESD</sub>	ESD Voltage (Human Body Model), according to EN61000-4-2 <sup>(2)</sup>	-	±4000	V

## OPERATING CONDITIONS

Operating conditions are conditions under which operation of the device is intended to be functional. All values are referenced to GND.

MIN and MAX limits are valid for the recommended ambient temperature range of **-40°C to 85°C**. Typical values represent statistically the utmost probability at the following conditions: V<sub>IN</sub> = 6V to 36V (173010335), V<sub>IN</sub> = 8V to 36V (173010535), I<sub>OUT</sub> = 1A<sup>(5)</sup>, T<sub>A</sub> = 25°C, unless otherwise specified.

SYMBOL	PARAMETER	MIN <sup>(1)</sup>	TYP <sup>(3)</sup>	MAX <sup>(1)</sup>	UNIT
V <sub>IN</sub>	Input voltage (173010335)	6	-	36	V
V <sub>IN</sub>	Input voltage (173010535)	8	-	36	V
T <sub>A</sub>	Ambient temperature range	-40	-	+85 <sup>(4)</sup>	°C
I <sub>OUT</sub>	Nominal output current	-	-	1	A
C <sub>OUT MAX</sub>	Maximum output capacitor	-	-	680	µF

173010335, 173010535

**Magl<sup>3</sup>C** Power Module  
**FDSM** – Fixed Step Down Regulator Module



### THERMAL SPECIFICATIONS

SYMBOL	PARAMETER	TYP <sup>(3)</sup>	UNIT
$\Theta_{CA}$	Case-to-ambient thermal resistance <sup>(5)</sup>	70	K/W
$T_{case\ max}$	Maximum case temperature <sup>(5)</sup>	100	°C
$T_{SD}$	Thermal shutdown, junction temperature rising	170	°C

### ELECTRICAL SPECIFICATIONS

MIN and MAX limits are valid for the recommended ambient temperature range of **-40°C to 85°C**. Typical values represent statistically the utmost probability at the following conditions:  $V_{IN} = 6V$  to  $36V$  (173010335),  $V_{IN} = 8V$  to  $36V$  (173010535),  $I_{OUT} = 1A$  <sup>(5)</sup>,  $T_A = 25°C$ , unless otherwise specified.

SYMBOL	PARAMETER	TEST CONDITIONS	MIN <sup>(1)</sup>	TYP <sup>(3)</sup>	MAX <sup>(1)</sup>	UNIT
<b>Output current</b>						
$I_{CL}$	Current limit threshold	$V_{IN} = 24V$	2.5	3.2	3.8	A
<b>Output voltage</b>						
$V_{OUT}$	Regulated output voltage	173010335	-	3.3	-	V
	Regulated output voltage	173010535	-	5	-	V
	Line regulation	$I_{OUT} = 1A$	-	$\pm 0.2$	$\pm 0.4$	%
	Load regulation	10% to 100% Load	-	$\pm 0.4$	$\pm 0.6$	%
	Total output voltage variation	Full load, input voltage range	-	$\pm 2$	$\pm 4$	%
	Output voltage ripple	External $C_{OUT} = 22\mu F$ X5R, 20MHz BWL				
		$V_{OUT} = 3.3V, I_{OUT} = 1A$	-	13.5	-	mV <sub>pp</sub>
		$V_{OUT} = 5V, I_{OUT} = 1A$	-	17.5	-	mV <sub>pp</sub>
<b>Switching frequency</b>						
$f_{SW}$	Switching frequency	$V_{IN} = 12V$ , Continuous Conduction Mode (CCM)	-	520	-	kHz
<b>Input current</b>						
$I_{IN}$	No load input current	Operating, switching	-	0.1	1	mA
<b>Efficiency</b>						
$\eta$	Efficiency	$V_{IN} = 6V, V_{OUT} = 3.3V$	-	92	-	%
		$V_{IN} = 36V, V_{OUT} = 3.3V$	-	81	-	%
		$V_{IN} = 8V, V_{OUT} = 5V$	-	94	-	%
		$V_{IN} = 36V, V_{OUT} = 5V$	-	86	-	%

### RELIABILITY

SYMBOL	PARAMETER	TEST CONDITIONS	TYP <sup>(3)</sup>	UNIT
MTBF <sup>(6)</sup>	Mean Time Between Failures	MIL-HDBK-217F, +25°C	$2000 \cdot 10^3$	h

173010335, 173010535

**Magl<sup>3</sup>C** Power Module  
**FDSM** – Fixed Step Down Regulator Module



### RoHS, REACH

RoHS Directive		Directive 2011/65/EU of the European Parliament and the Council of June 8th, 2011 on the restriction of the use of certain hazardous substances in electrical and electronic equipment.
REACH Directive		Directive 1907/2006/EU of the European Parliament and the Council of June 1st, 2007 regarding the Registration, Evaluation, Authorisation and Restriction of Chemicals (REACH)

### PACKAGE SPECIFICATIONS

ITEM	PARAMETER	TYP <sup>(3)</sup>	UNIT
Case	Black flame-retardant and heat-resistant plastic (UL94 V-0)	-	-
Potting material	Silicone, UL94V-0	-	-
Weight		1.8	g
Vibration	5g for 20min	MIL-STD-202, Method 204	

### NOTES

- (1) Min and Max limits are 100% production tested at 25°C. Limits over the operating temperature range are guaranteed through correlation using Statistical Quality Control (SQC) methods.
- (2) The human body model is a 100pF capacitor discharged through a 1.5 kΩ resistor into each pin. Test method is per JESD-22-114.
- (3) Typical numbers are valid at 25°C ambient temperature and represent statistically the utmost probability assuming the Gaussian distribution.
- (4) Depending on load current, see derating diagram.
- (5) Measured without heatsink, no airflow.
- (6) MIL-HDBK-217F; GB Ground, Benign: Non mobile, temperature and humidity controlled environments readily accessible to maintenance; includes laboratory instruments and test equipment, medical electronic equipment, business and scientific computer complexes, and missiles and support equipment in ground silos.

## 173010335, 173010535

### MagI<sup>3</sup>C Power Module FDSM – Fixed Step Down Regulator Module



#### TYPICAL PERFORMANCE CURVES

If not otherwise specified, the following conditions apply:  $V_{IN} = 24V$ ;  $V_{OUT} = 3.3V$  (173010335) &  $5V$  (173010535);  $I_{OUT} = 1A$ ;  $T_{AMB} = 25^{\circ}C$ .

#### RADIATED AND CONDUCTED EMISSIONS (WITH EMI INPUT FILTER)

The 173010335 & 173010535 power modules are tested with standard EMC configuration (1m wire between the module and the load) to give more realistic information about implementation in the applications. The test setup is based on CISPR16 with the limit values CISPR32.

Measured with module on an Evaluation Board 17800FDSM in a Fully Anechoic Room (FAR) at 3m antenna distance.

#### TEST SETUP

Input wire length:

- Radiated Emission: 160cm (80cm Horizontal + 80cm Vertical)
- Conducted Emission: 80cm

Output wire length

- Radiated & Conducted Emission: 1m

173010335, 173010535

**Mag<sup>3</sup>C** Power Module  
**FDSM** – Fixed Step Down Regulator Module



3.3V<sub>OUT</sub>:

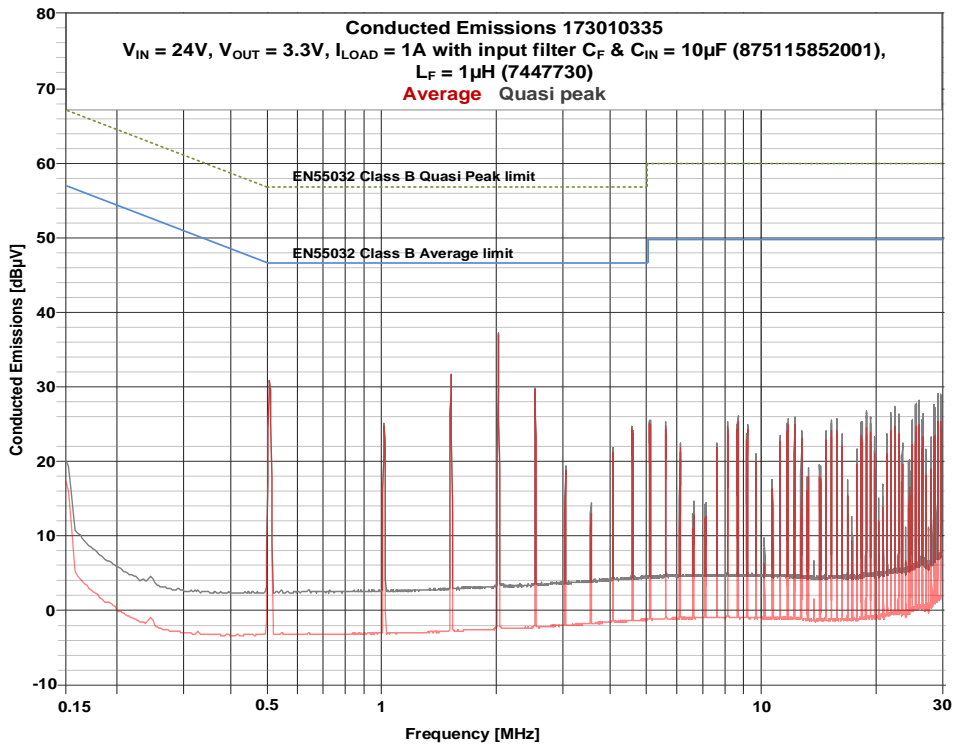
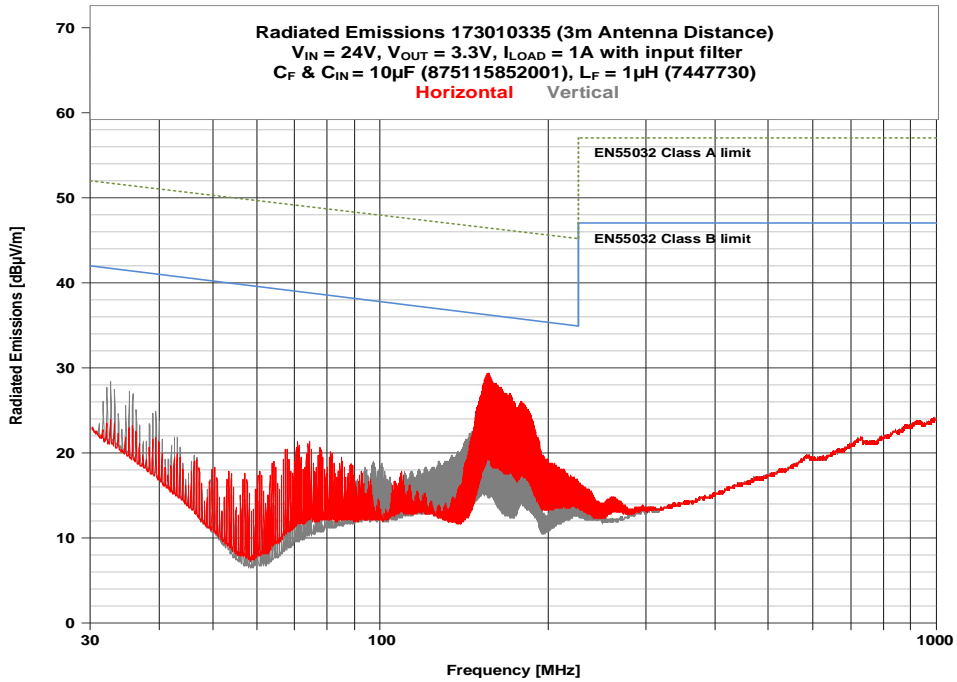



173010335, 173010535

**Magl<sup>3</sup>C** Power Module  
**FDSM** – Fixed Step Down Regulator Module



5V<sub>out</sub>:

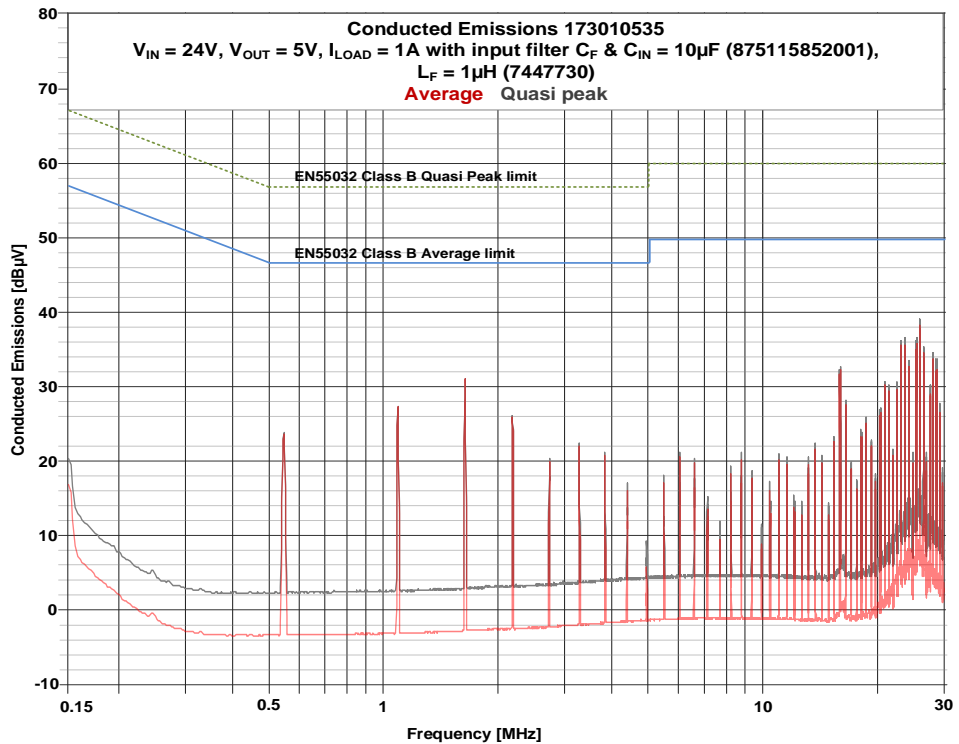
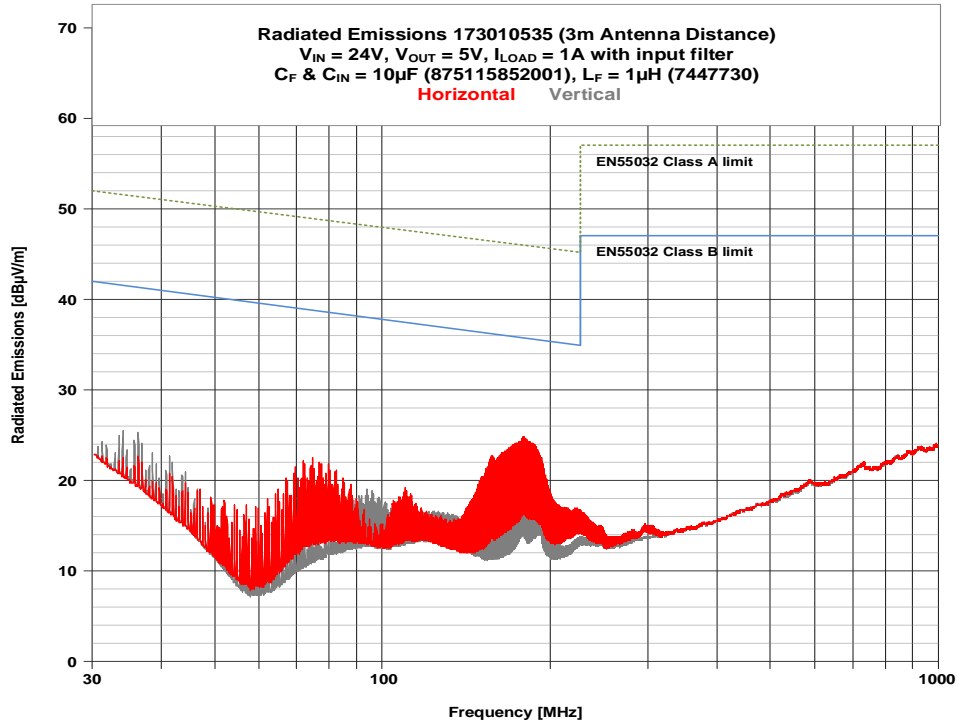

# 173010335, 173010535

**MagI<sup>3</sup>C** Power Module  
**FDSM** – Fixed Step Down Regulator Module



## EFFICIENCY

173010335  $V_{OUT} = 3.3V$ ,  $f_{SW} = 520kHz$ ,  $T_A = 25^\circ C$

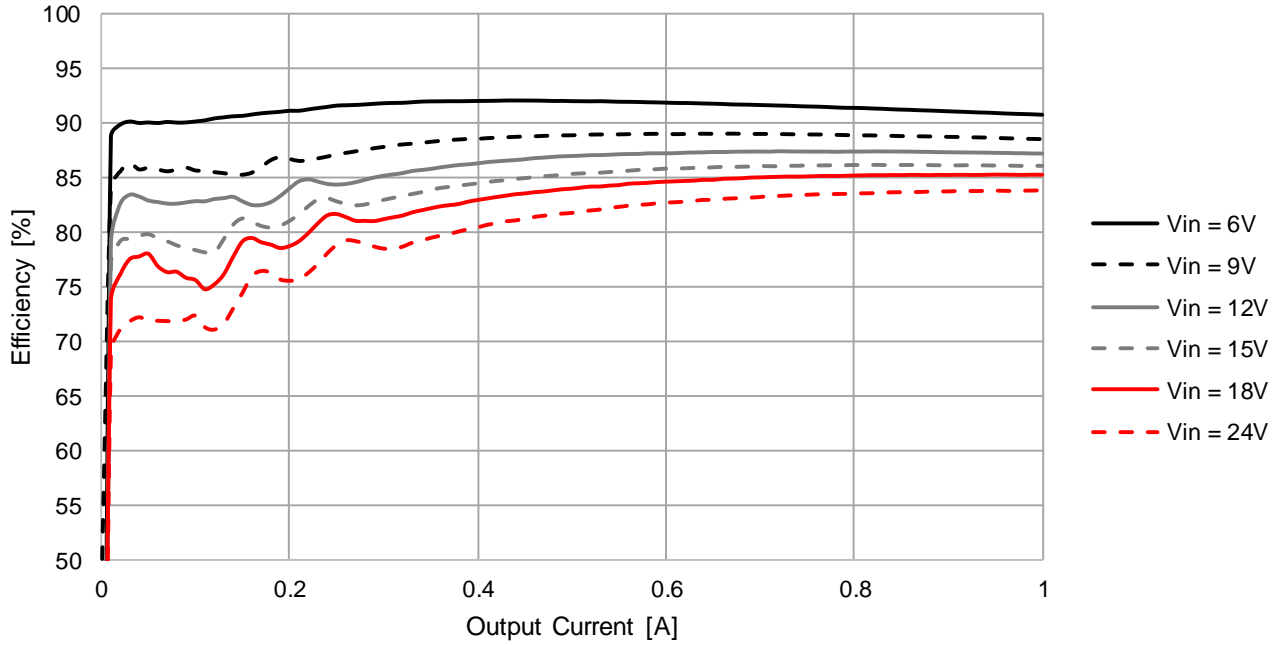

173010335  $V_{OUT} = 3.3V$ ,  $f_{SW} = 520kHz$ ,  $T_A = 85^\circ C$

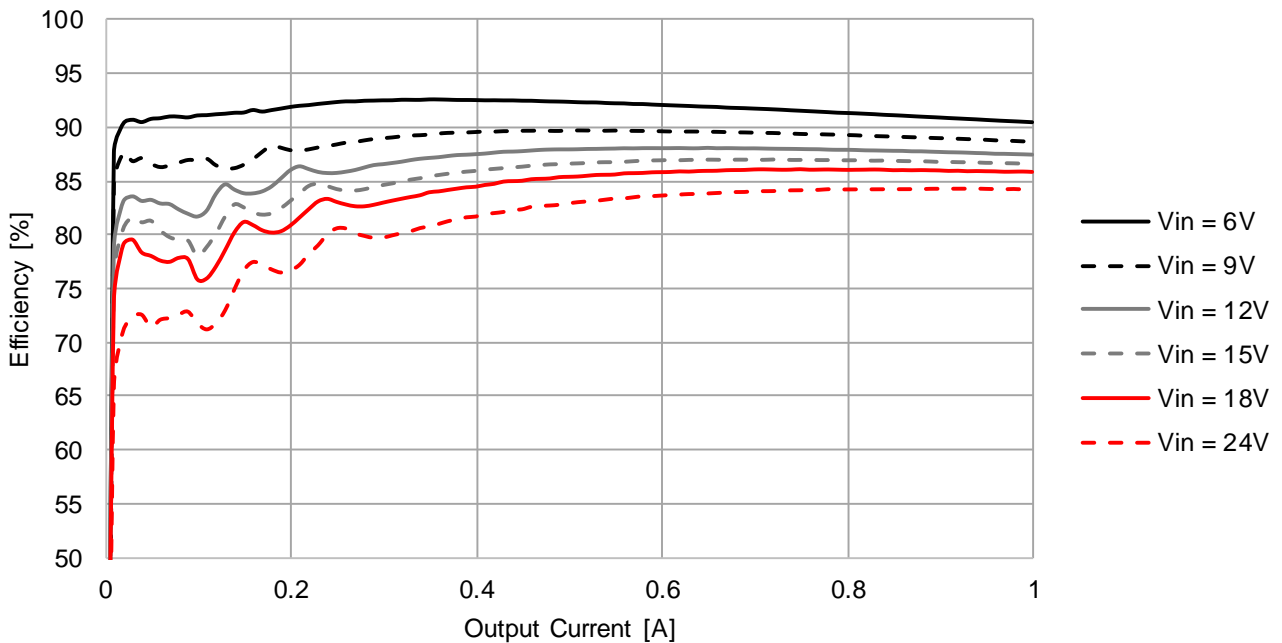

# 173010335, 173010535

**MagI<sup>3</sup>C** Power Module  
**FDSM** – Fixed Step Down Regulator Module



## EFFICIENCY

173010535  $V_{OUT} = 5V$ ,  $f_{SW} = 520kHz$ ,  $T_A = 25^\circ C$

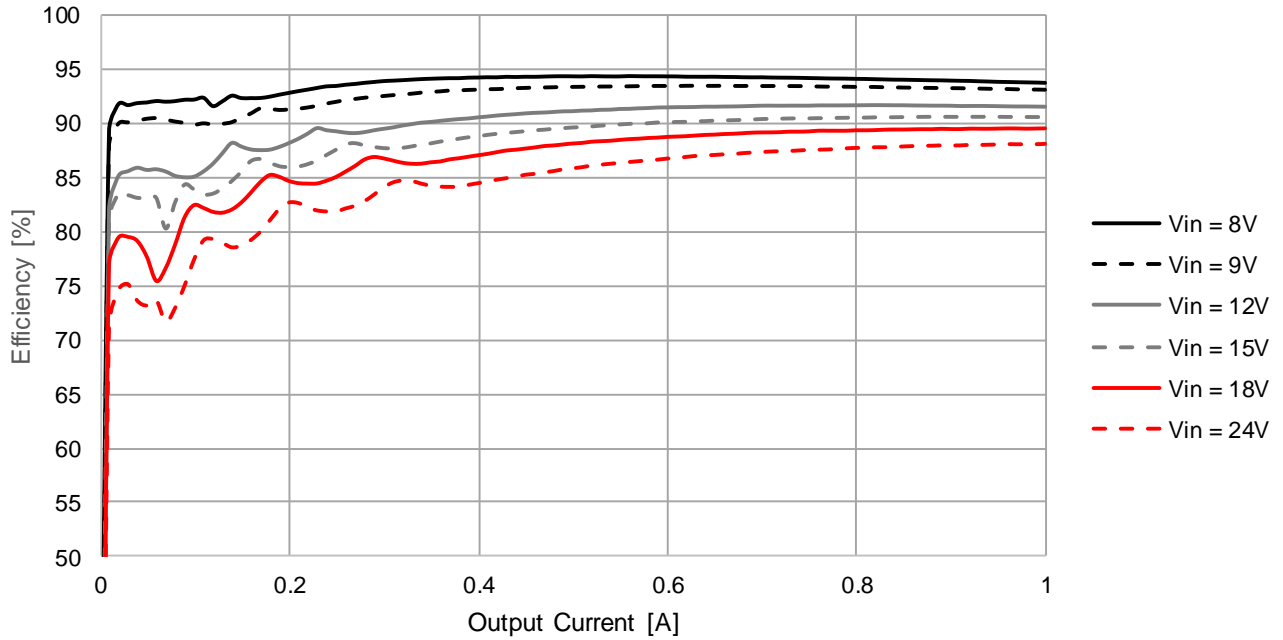

173010535  $V_{OUT} = 5V$ ,  $f_{SW} = 520kHz$ ,  $T_A = 85^\circ C$

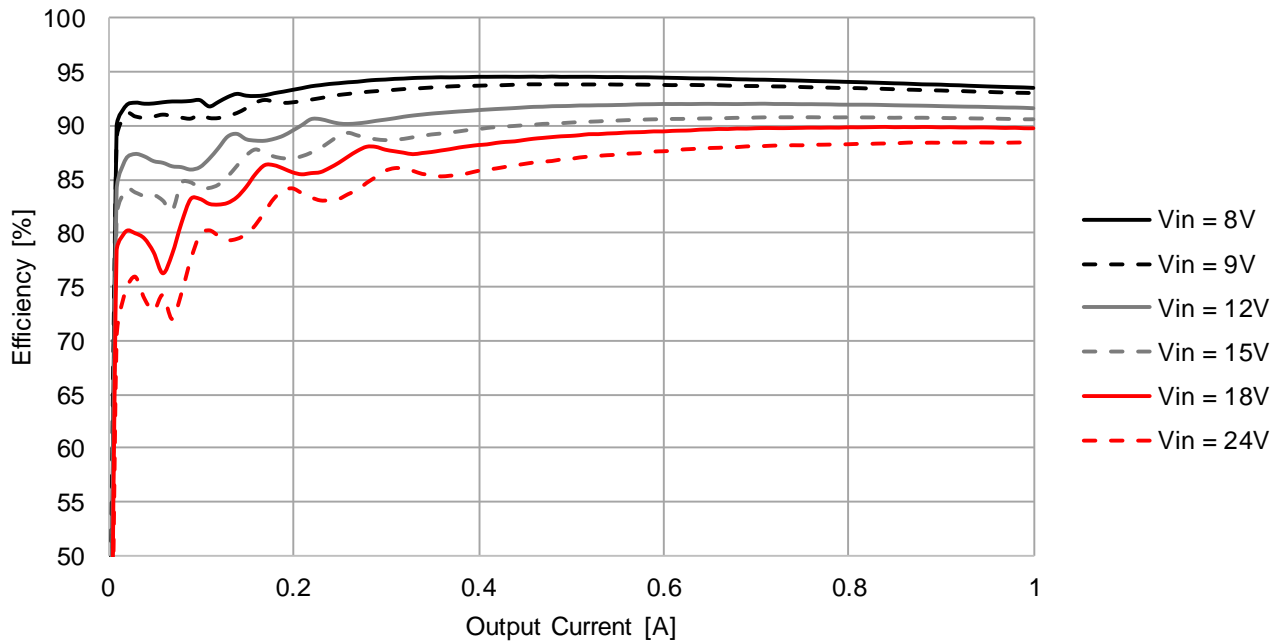

# 173010335, 173010535

**MagI<sup>3</sup>C** Power Module  
**FDSM** – Fixed Step Down Regulator Module



## POWER DISSIPATION

173010335  $V_{OUT} = 3.3V$ ,  $f_{SW} = 520kHz$ ,  $T_A = 25^\circ C$

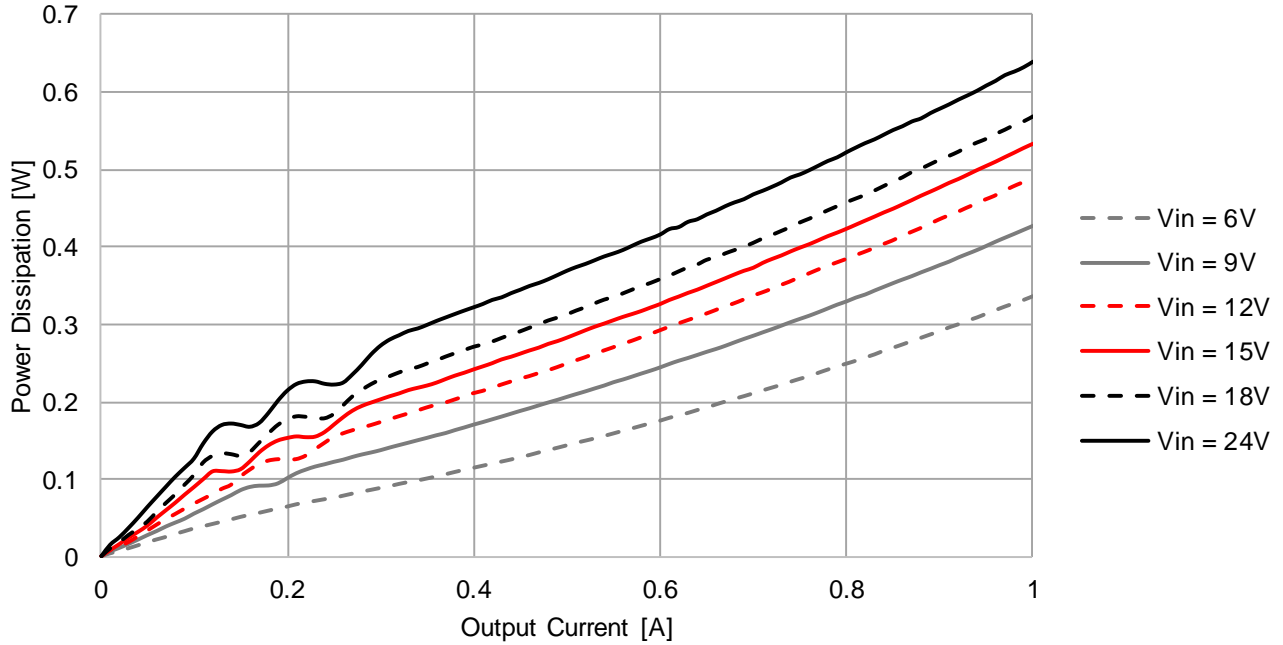

173010335  $V_{OUT} = 3.3V$ ,  $f_{SW} = 520kHz$ ,  $T_A = 85^\circ C$

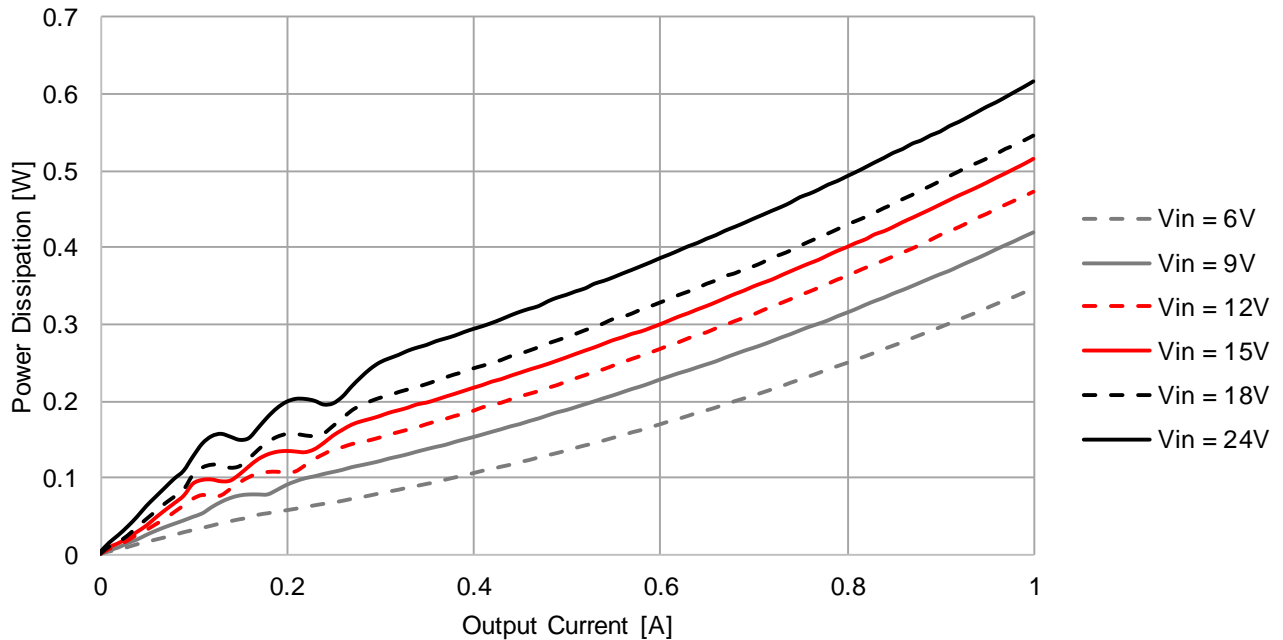

# 173010335, 173010535

**MagI<sup>3</sup>C** Power Module  
**FDSM** – Fixed Step Down Regulator Module



## POWER DISSIPATION

173010535  $V_{OUT} = 5V$ ,  $f_{SW} = 520kHz$ ,  $T_A = 25^\circ C$

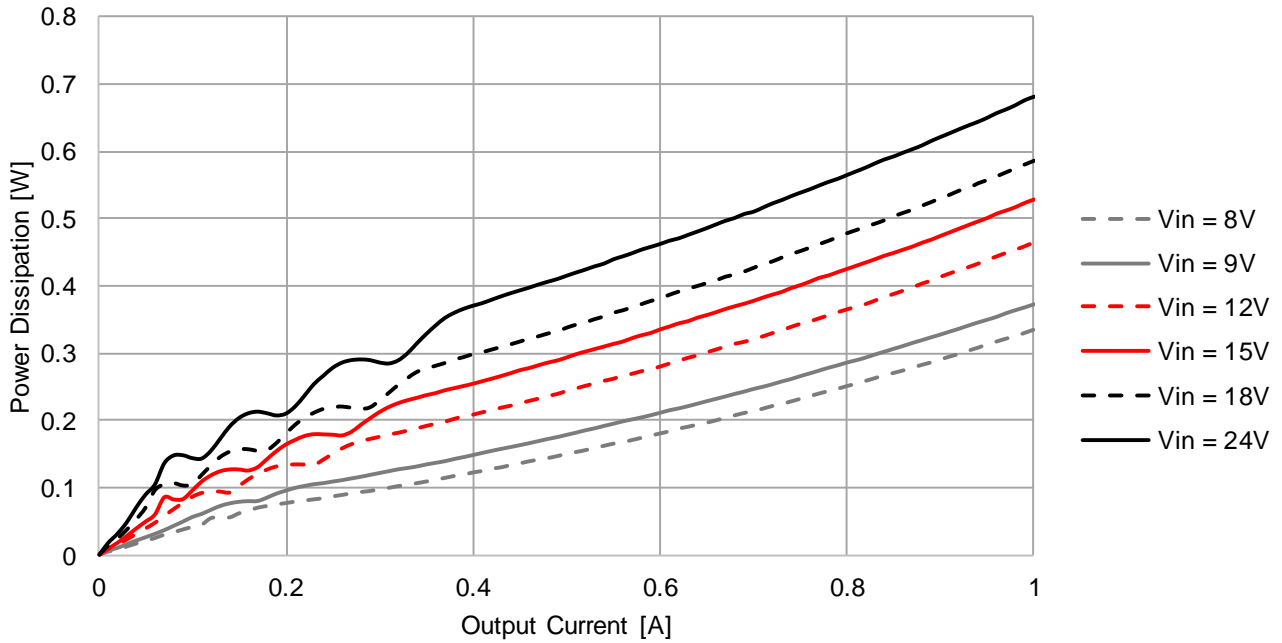

173010535  $V_{OUT} = 5V$ ,  $f_{SW} = 520kHz$ ,  $T_A = 85^\circ C$

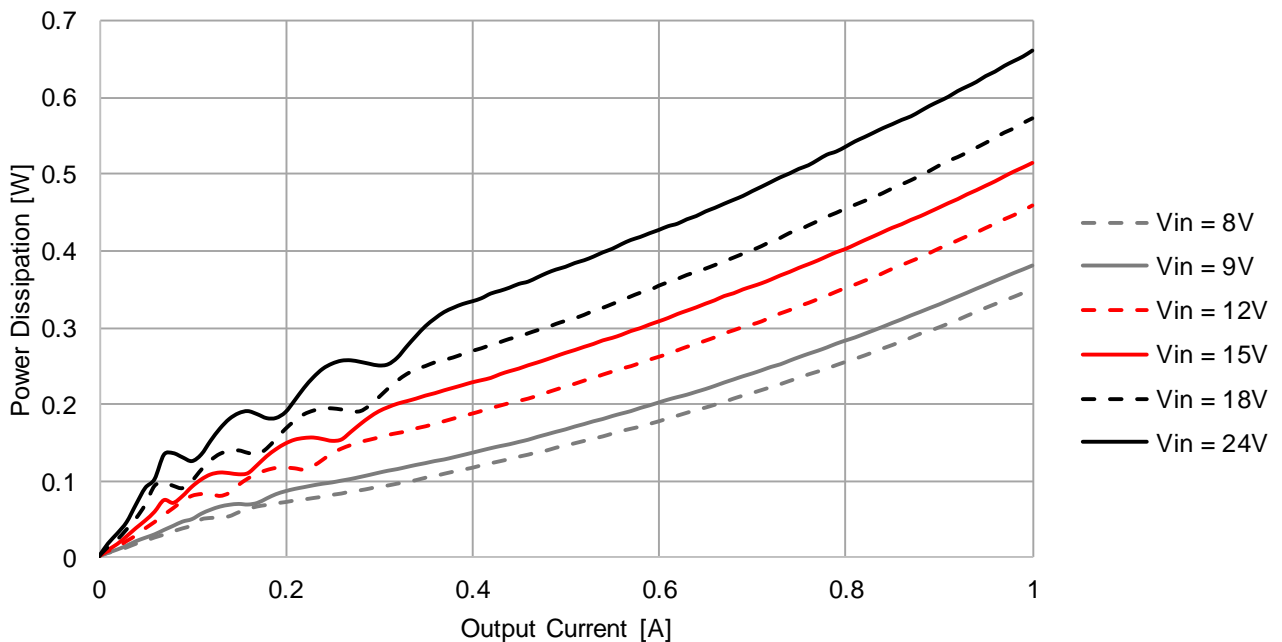

173010335, 173010535

**MagI<sup>3</sup>C** Power Module  
**FDSM** – Fixed Step Down Regulator Module



**OUTPUT POWER DERATING**

173010x35 Output Power Thermal Derating  
 $V_{IN} = 24V, I_{OUT} = 1A, f_{SW} = 520kHz$

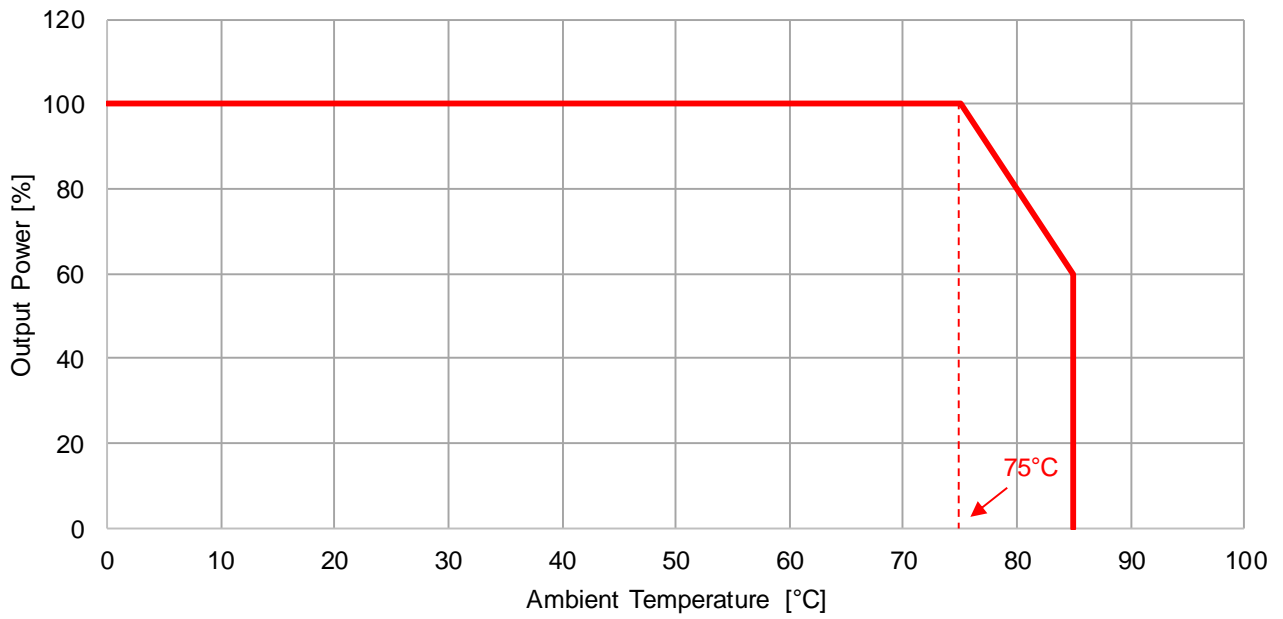

# 173010335, 173010535

**MagI<sup>3</sup>C** Power Module  
**FDSM** – Fixed Step Down Regulator Module



## LINE REGULATION

173010335 Line Regulation  $V_{OUT} = 3.3V$ ,  $T_A = 25^\circ C$

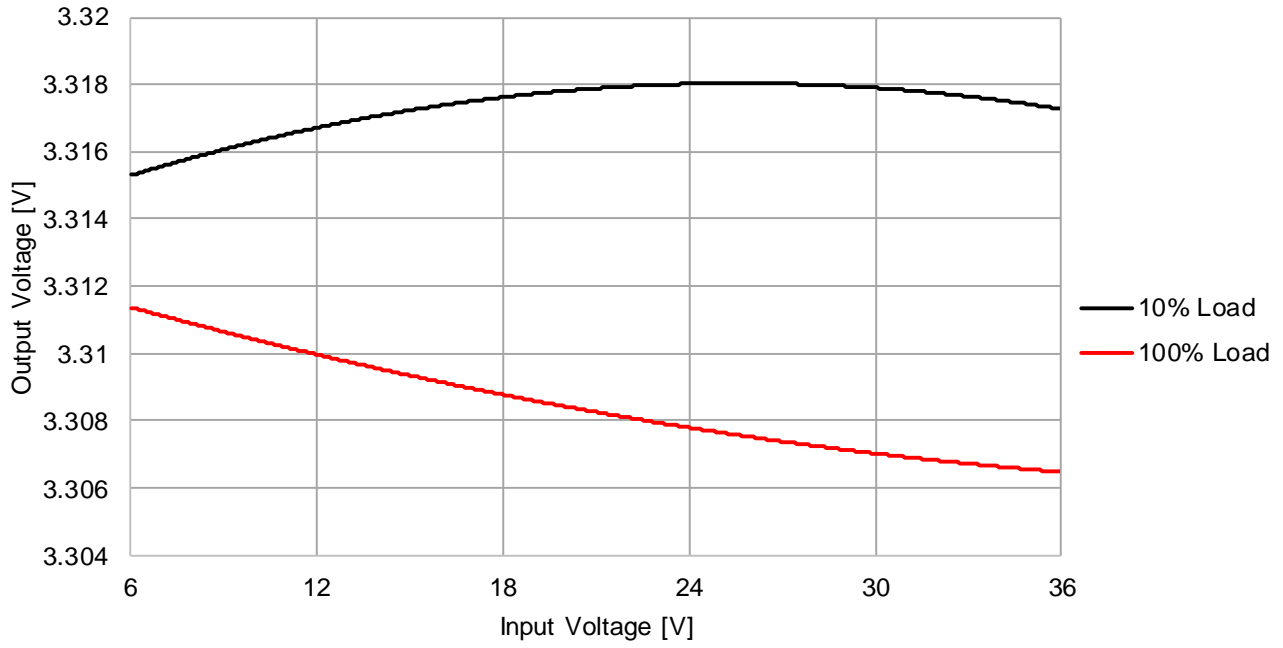

173010335 Line Regulation  $V_{OUT} = 3.3V$ ,  $T_A = 85^\circ C$

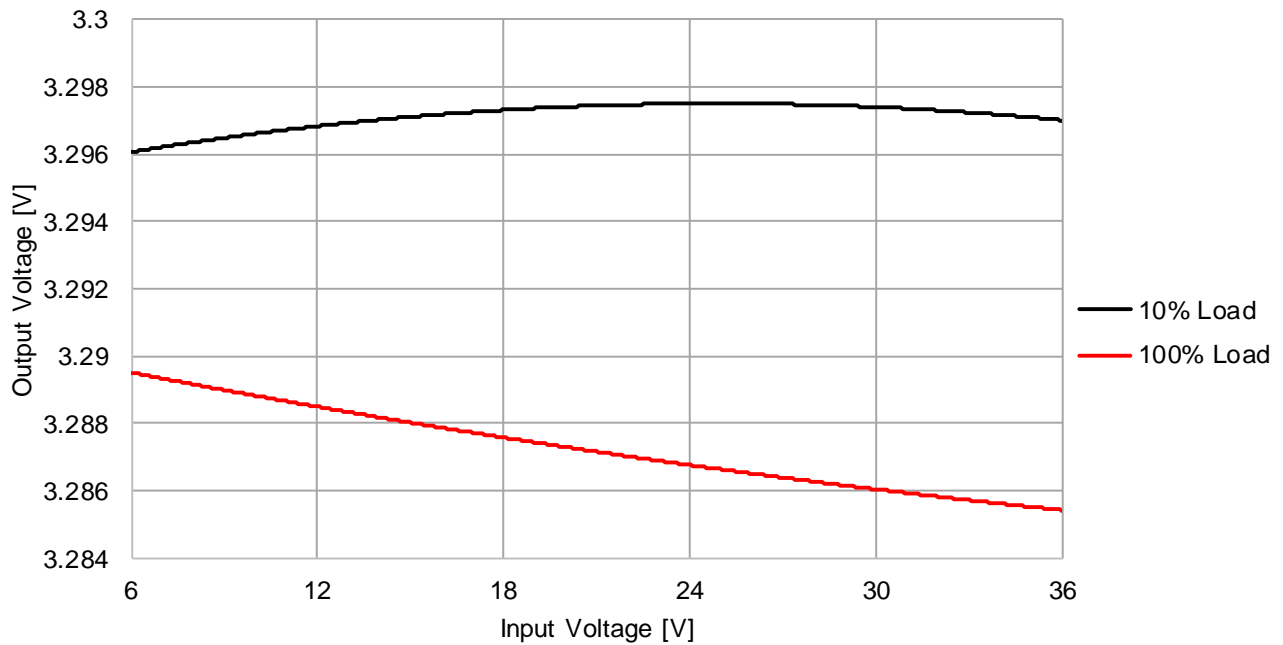

# 173010335, 173010535

**MagI<sup>3</sup>C** Power Module  
**FDSM** – Fixed Step Down Regulator Module



## LINE REGULATION

173010535 Line Regulation  $V_{OUT} = 5V$ ,  $T_A = 25^\circ C$

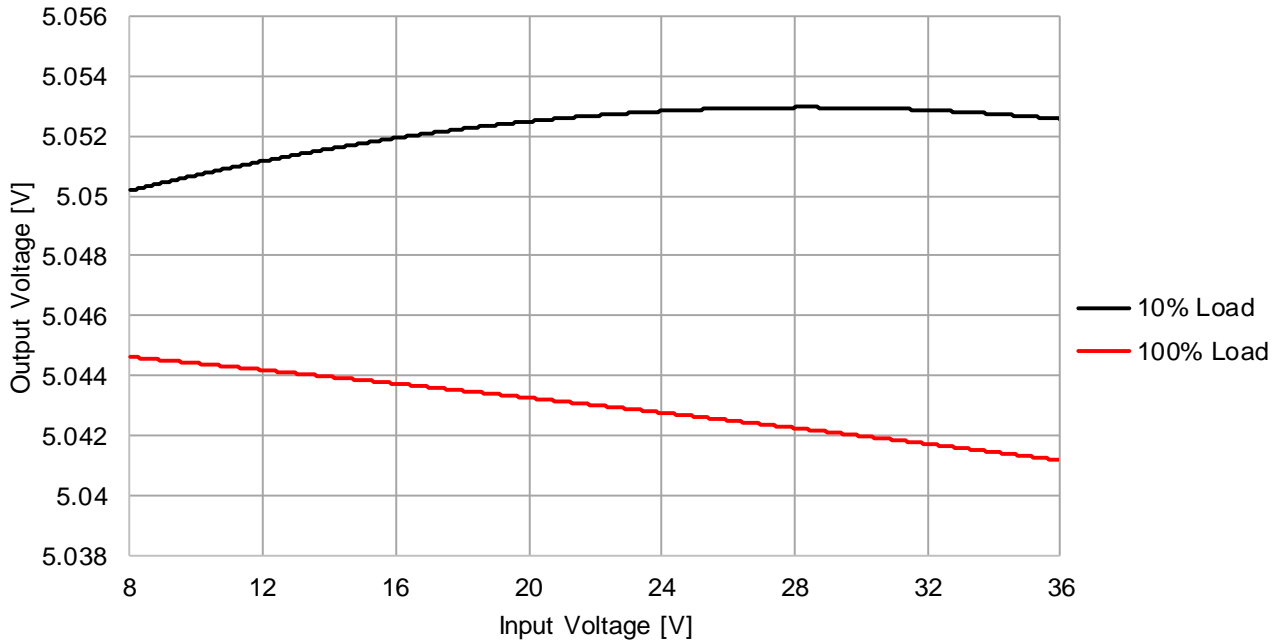

173010535 Line Regulation  $V_{OUT} = 5V$ ,  $T_A = 85^\circ C$

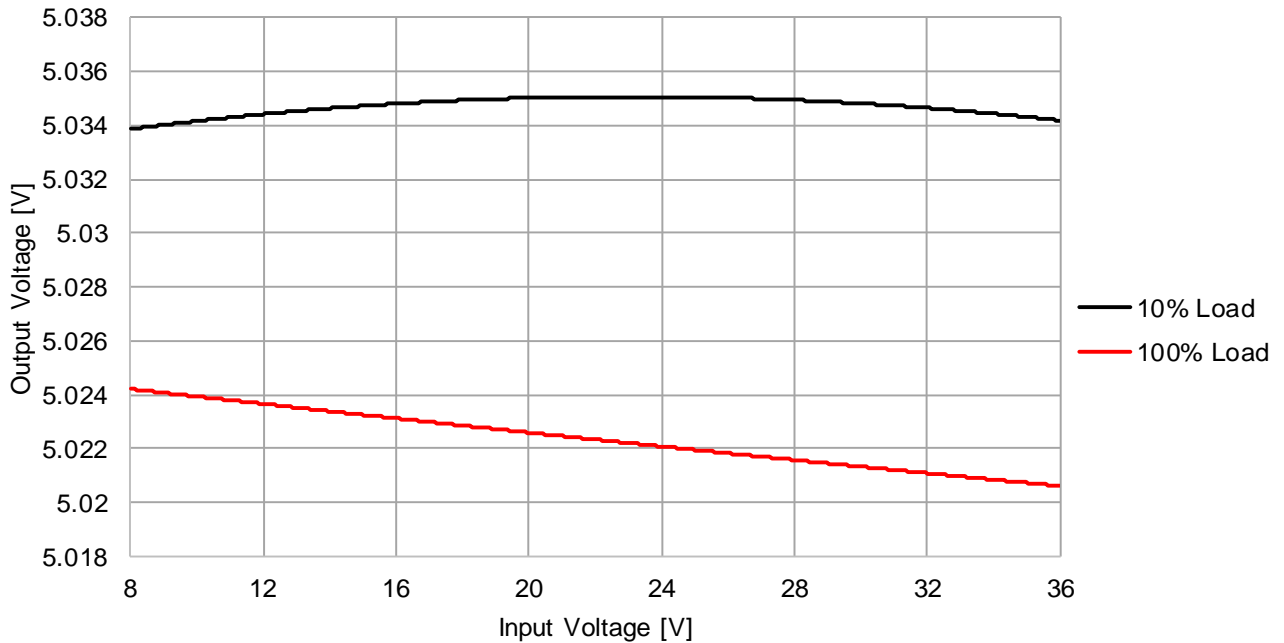



# 173010335, 173010535

**MagI<sup>3</sup>C** Power Module  
**FDSM** – Fixed Step Down Regulator Module



## LOAD REGULATION

173010335 Load Regulation  $V_{OUT} = 3.3V$ ,  $T_A = 25^\circ C$

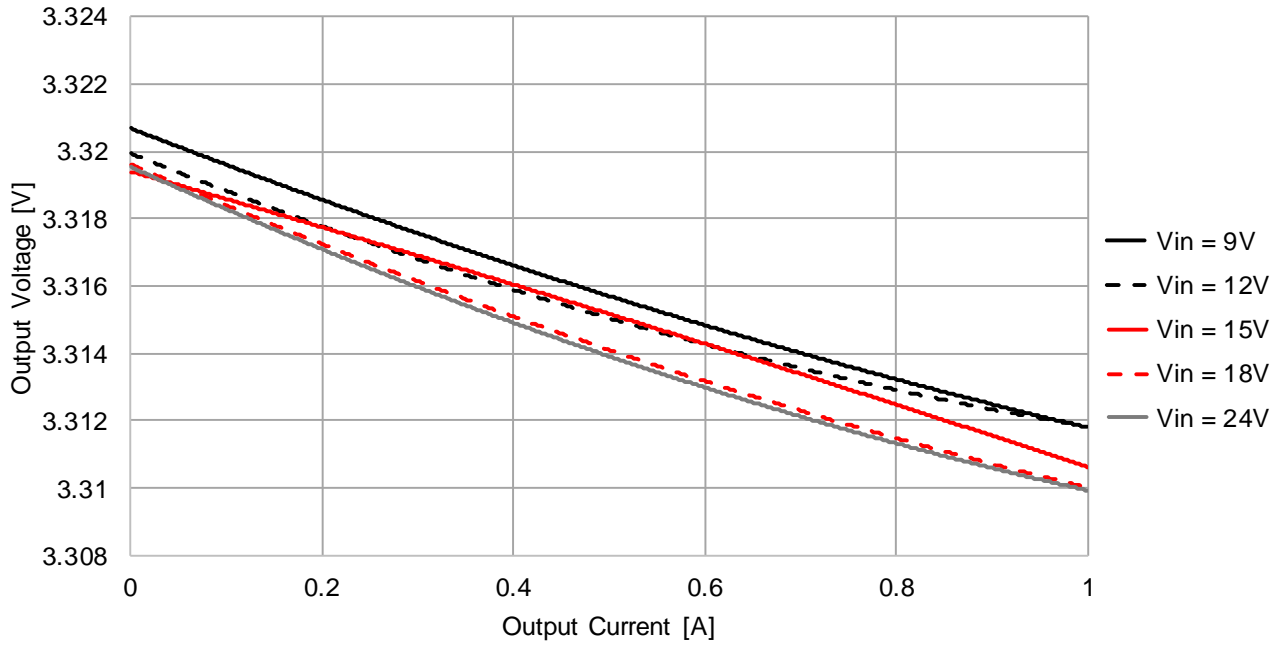

173010335 Load Regulation  $V_{OUT} = 3.3V$ ,  $T_A = 85^\circ C$

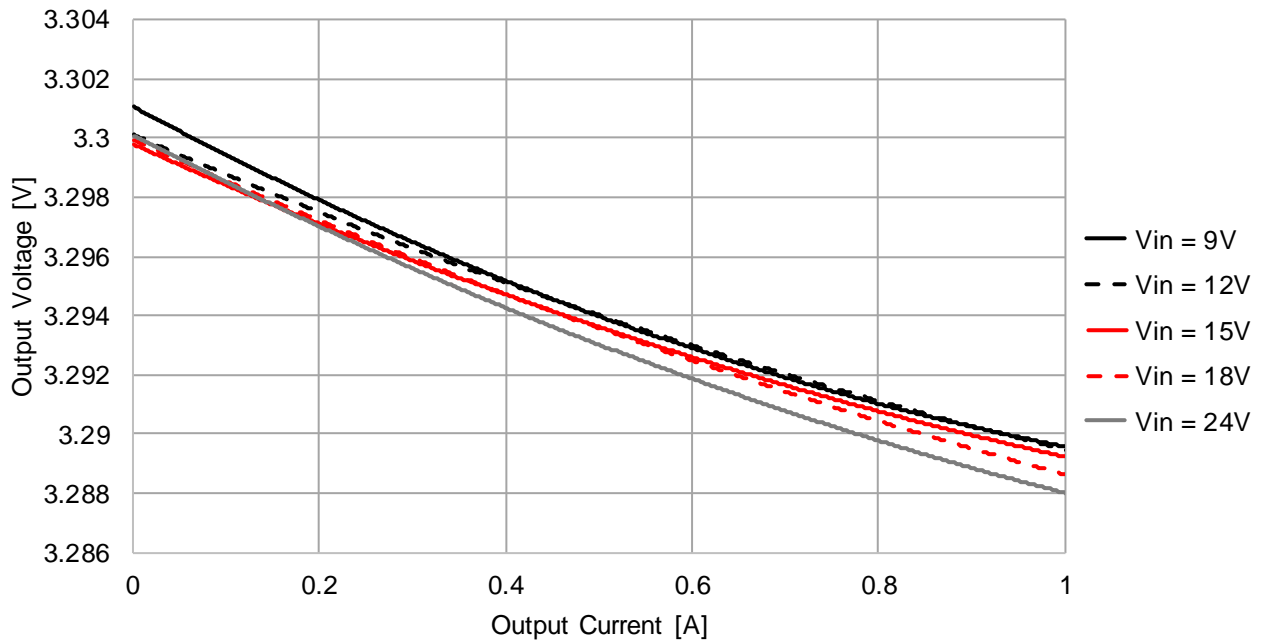

173010335, 173010535

**MagI<sup>3</sup>C** Power Module  
**FDSM** – Fixed Step Down Regulator Module



**LOAD REGULATION**

173010535 Load Regulation  $V_{OUT} = 5V$ ,  $T_A = 25^\circ C$

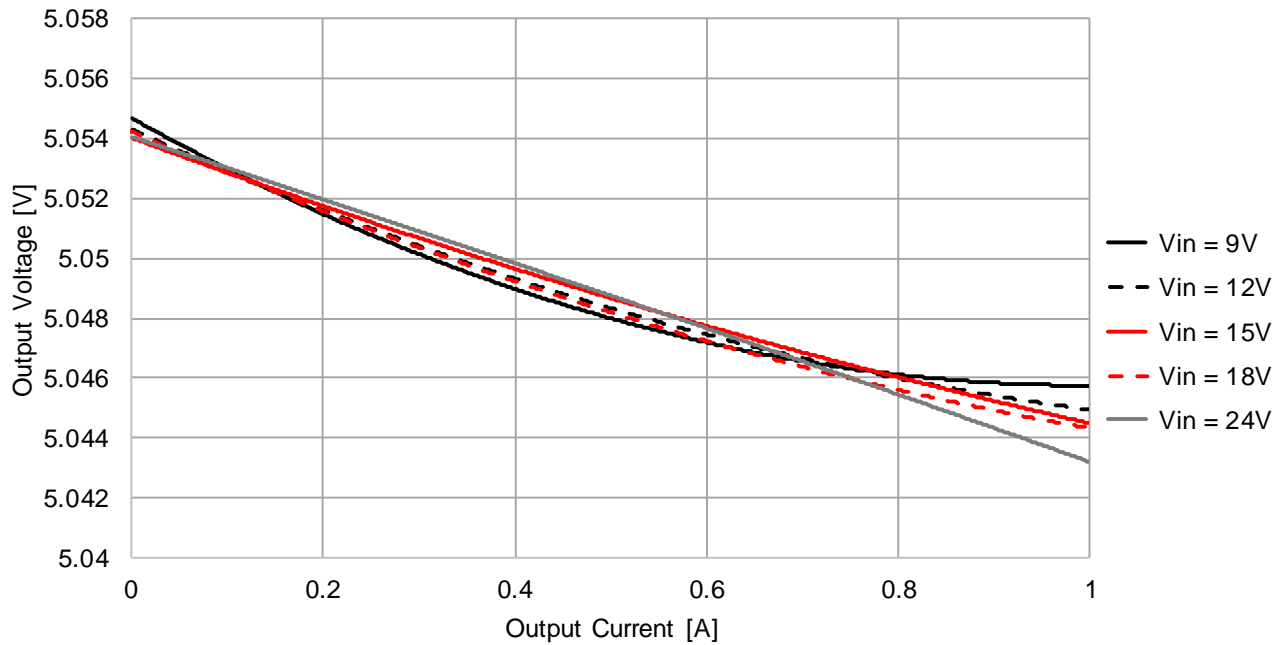

173010535 Load Regulation  $V_{OUT} = 5V$ ,  $T_A = 85^\circ C$

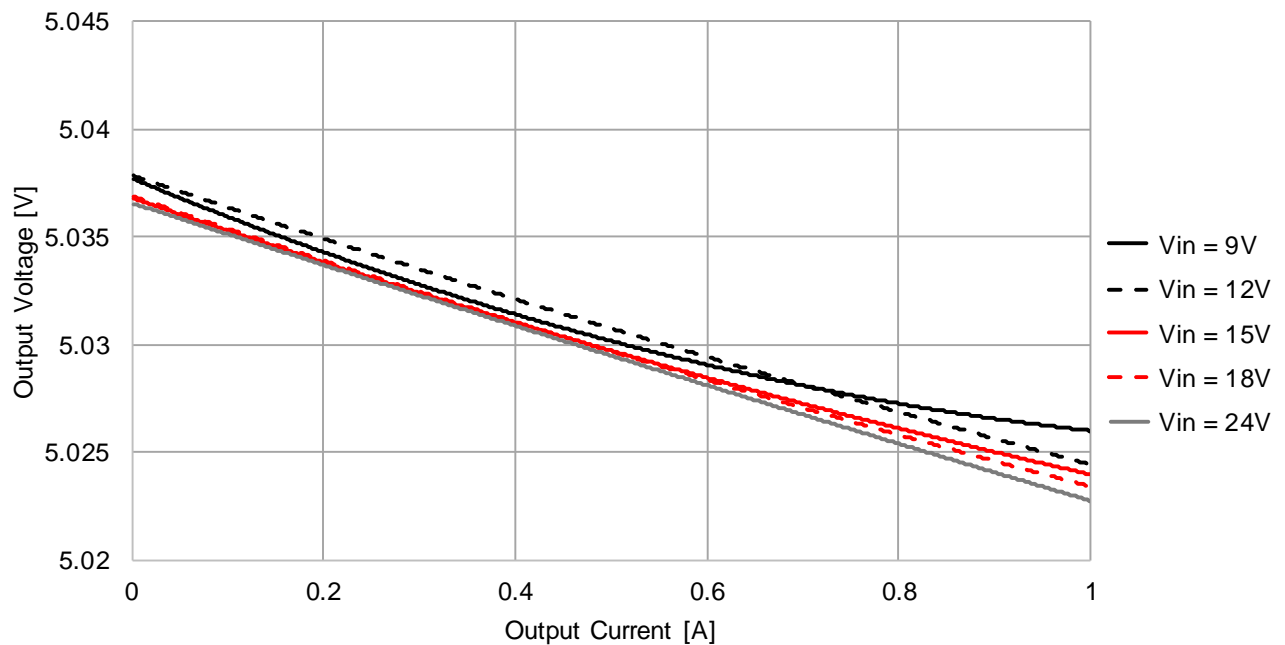

## 173010335, 173010535

**MagI<sup>3</sup>C** Power Module  
**FDSM** – Fixed Step Down Regulator Module

## BLOCK DIAGRAM

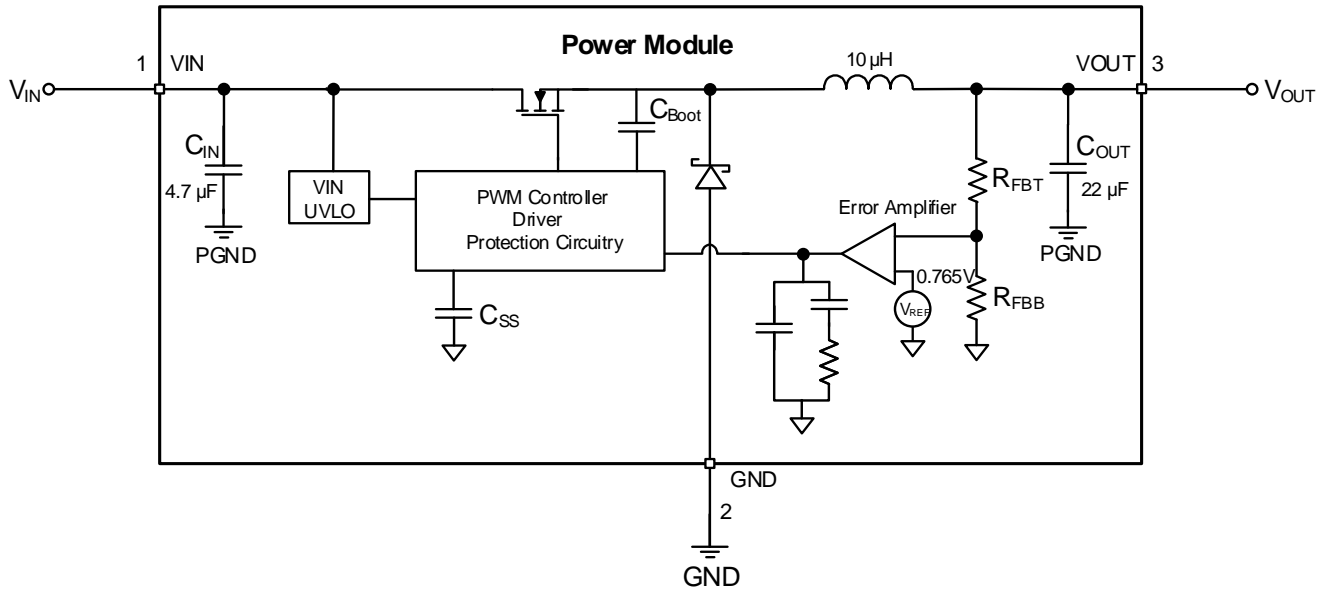

## CIRCUIT DESCRIPTION

The MagI<sup>3</sup>C power modules 173010x35 are based on a non-synchronous step-down regulator with integrated MOSFET, free-wheeling diode, power inductor, input and output capacitors. The control scheme is based on a Current Mode (CM) regulation loop.

The  $V_{OUT}$  of the regulator is divided with the internal feedback resistor network and fed into the error amplifier, which compares this signal with the internal 0.765V reference. The error signal is amplified and controls the on-time of a fixed frequency pulse width generator. This signal drives the MOSFET.

The Current Mode architecture features a constant frequency during load steps. Only the on-time is modulated. It is internally compensated and stable with low ESR output capacitors. No external compensation network is required. This architecture supports fast transient response and very small output voltage ripple values (< 20mV) are achieved.

173010335, 173010535

**MagI<sup>3</sup>C** Power Module  
**FDSM** – Fixed Step Down Regulator Module



## OUTPUT VOLTAGE RIPPLE

The output voltage ripple depends on several parameters. The figure below shows the  $V_{OUT}$  ripple at full load and using a  $22\mu\text{F}$  MLCC output capacitor. An output voltage ripple of less than  $20\text{mV}$  is measured under the conditions indicated.

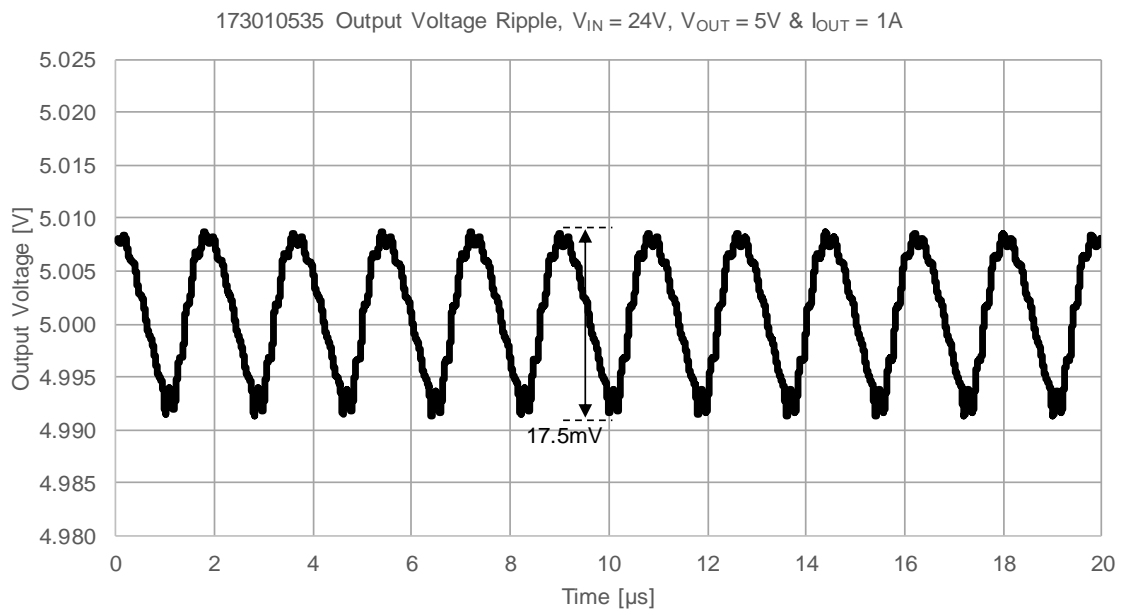
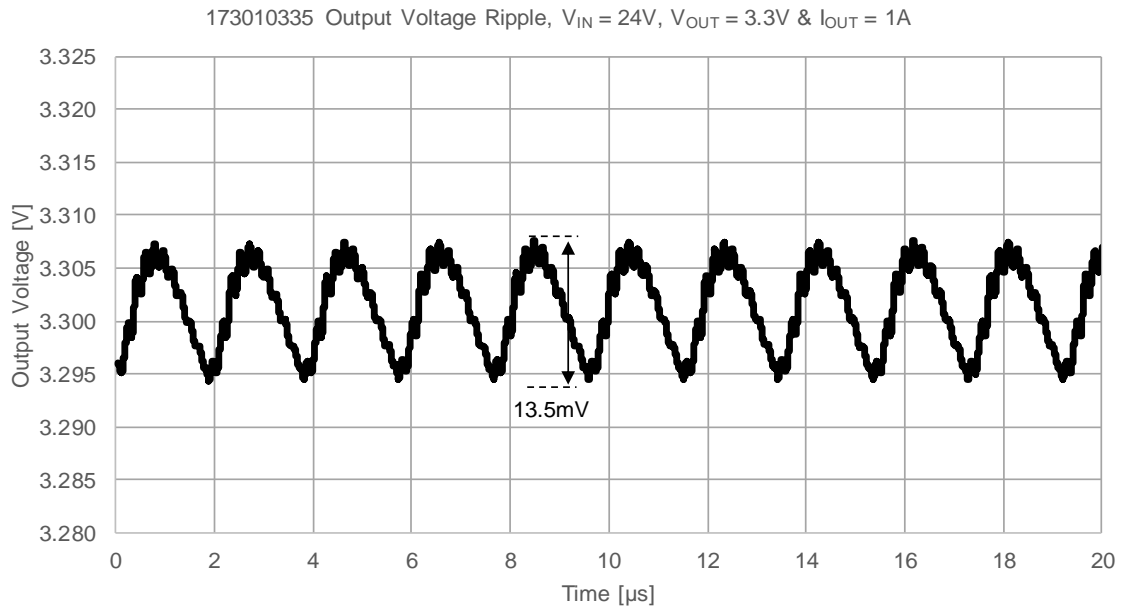

173010335, 173010535

**MagI<sup>3</sup>C** Power Module  
**FDSM** – Fixed Step Down Regulator Module



## LIGHT LOAD OPERATION

Under light load operation, the device switches from in Continuous Conduction Mode (CCM) to Discontinuous Conduction Mode (DCM). The load current where the transition between DCM and CCM takes place can be estimated using the following formula:

$$I_{OUT(DCM)} = \frac{V_{OUT} \cdot \left(1 - \frac{V_{OUT}}{V_{IN}}\right)}{2 \cdot f_{SW} \cdot L} \quad (1)$$

The following figures show the device working in CCM and DCM.

173010x35 Inductor Ripple Current  $V_{IN} = 24V$  &  $I_{OUT} = 1A$   
 CCM Operation

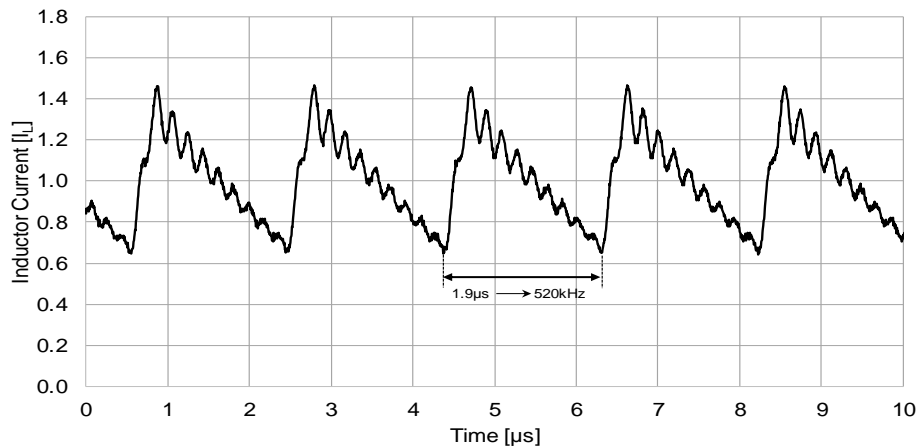

173010x35 Inductor Ripple Current  $V_{IN} = 24V$  &  $I_{OUT} = 500mA$   
 CCM Operation

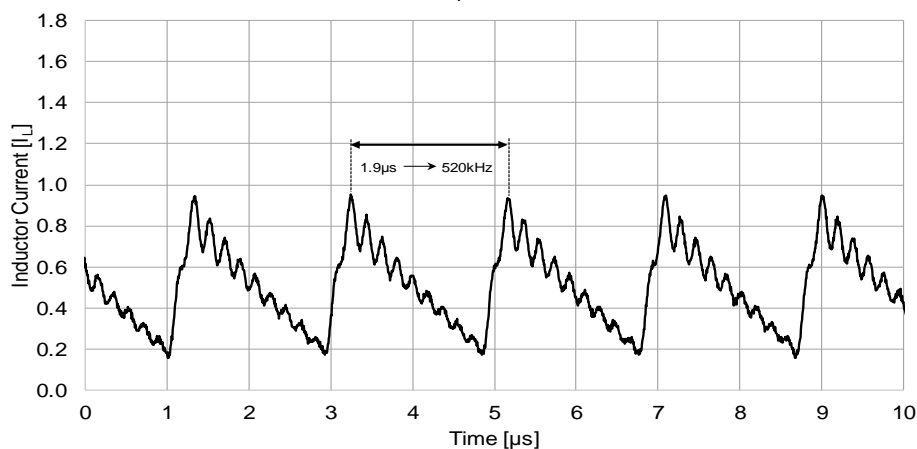

173010335, 173010535

**MagI<sup>3</sup>C** Power Module  
**FDSM** – Fixed Step Down Regulator Module



If the load current is further reduced, the device decreases the switching frequency in order to limit the energy transferred to the output (to both capacitor and load) and therefore keeping the output voltage regulated. The frequency reduction is shown in the figures below.

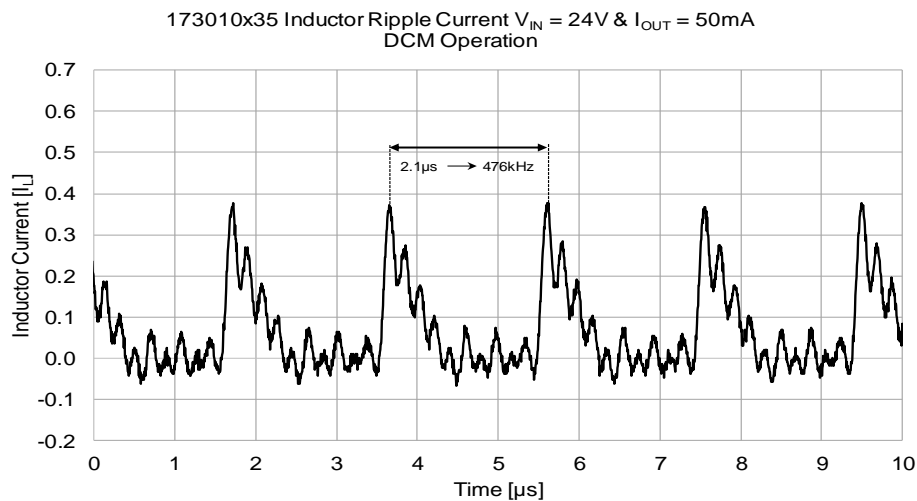
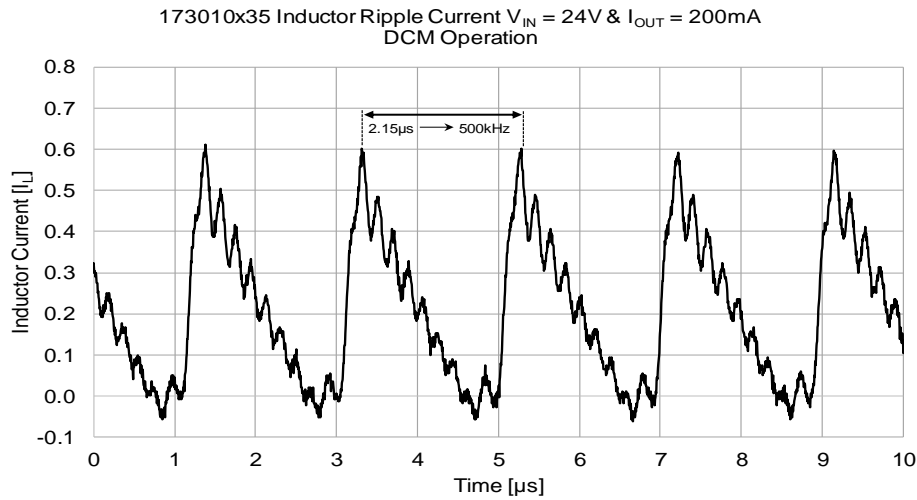

## 173010335, 173010535

**MagI<sup>3</sup>C** Power Module  
**FDSM** – Fixed Step Down Regulator Module

**SOFT-START**

In order to prevent the output voltage from overshooting during start-up, a soft-start is implemented. The soft-start is internally set and lasts around 0.75ms - 0.8ms for 173010335 and 173010535 respectively. The figures below show the start-up behavior of the power module with 3.3V and 5V output voltage respectively.

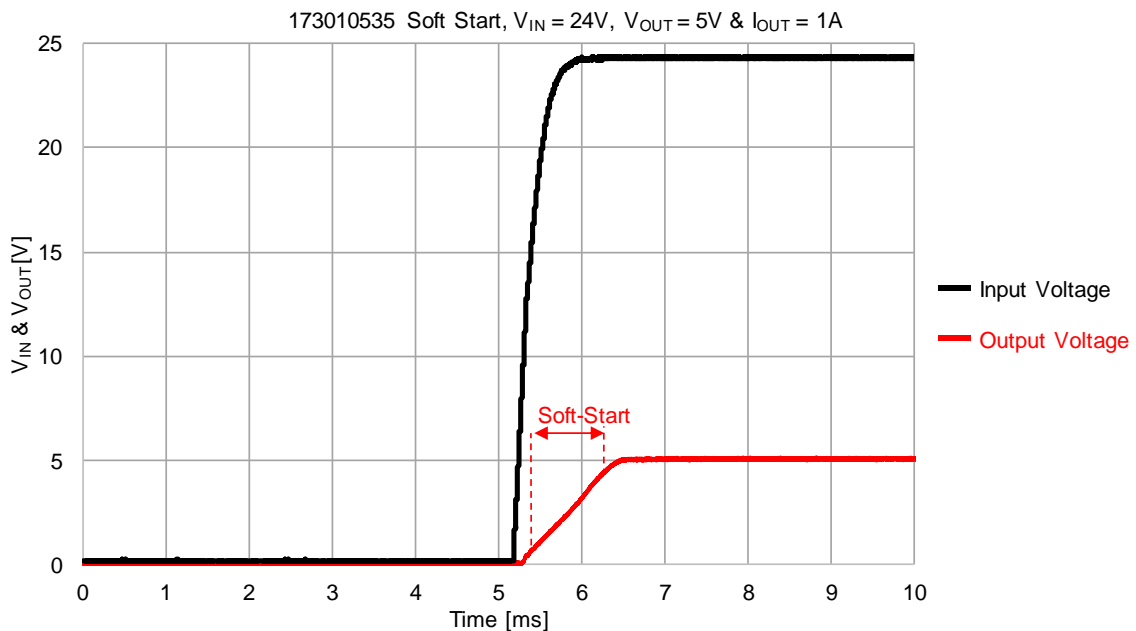
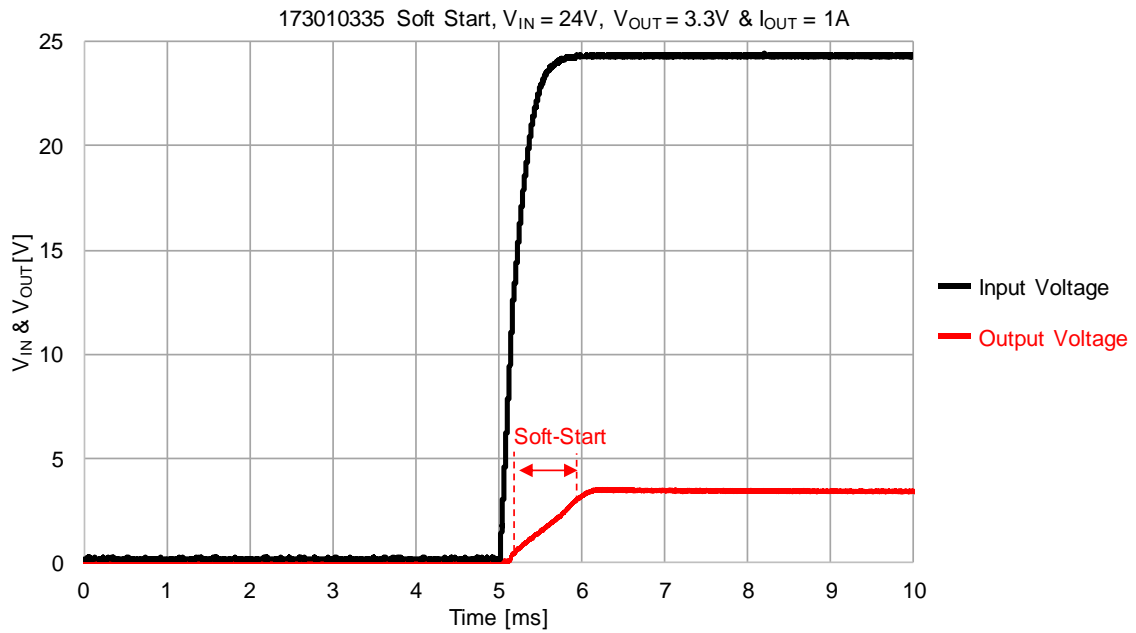

173010335, 173010535

**MagI<sup>3</sup>C** Power Module  
**FDSM** – Fixed Step Down Regulator Module



## PROTECTIVE FEATURES

### Over temperature protection (OTP)

Thermal protection helps to prevent catastrophic failures due to accidental device overheating. The junction temperature of the MagI<sup>3</sup>C Power Module should not be allowed to exceed its maximum ratings. Thermal protection is implemented by an internal thermal shutdown circuit which activates at 170°C (typ.), causing the device to enter a low power standby state. In this state, the MOSFET remains off causing  $V_{OUT}$  to fall. When the junction temperature falls back below 158° (hysteresis is implemented)  $V_{OUT}$  rises smoothly and normal operation resumes.

### Short circuit protection (SCP)

The short circuit protection is realized via cycle by cycle current monitoring. Recovery from short circuit protection mode occurs during the switching cycle following the removal of the short circuit condition. When the 173010x35 recovers from a short circuit condition, the soft-start is not active. Therefore, an overshoot at the output voltage can be observed (see figure below). Under short circuit conditions, the input current is limited.

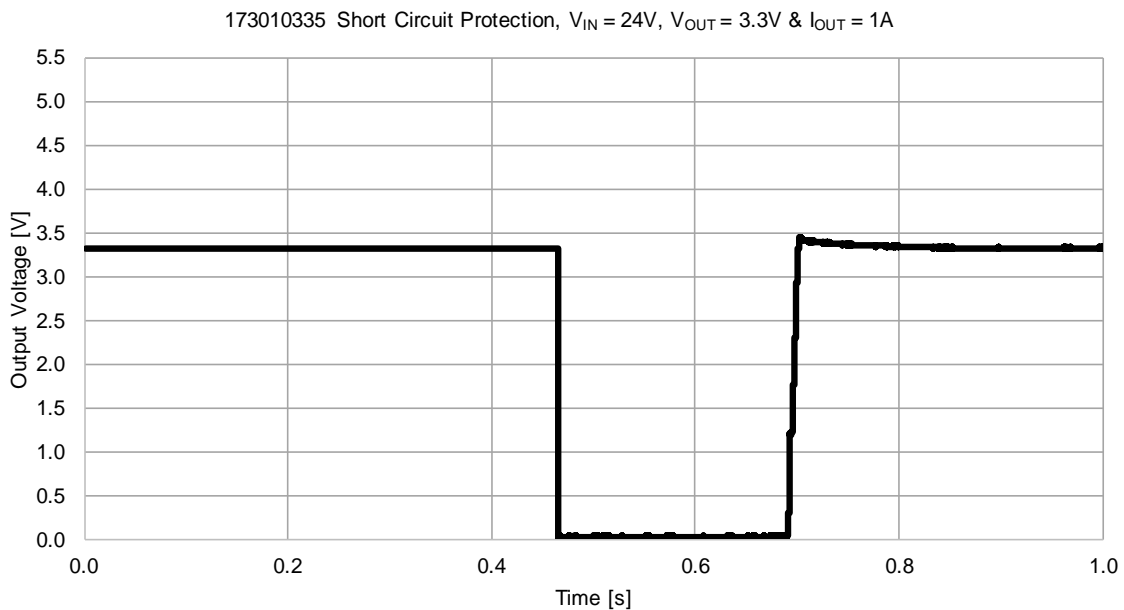



173010335, 173010535

**MagI<sup>3</sup>C** Power Module  
FDSM – Fixed Step Down Regulator Module

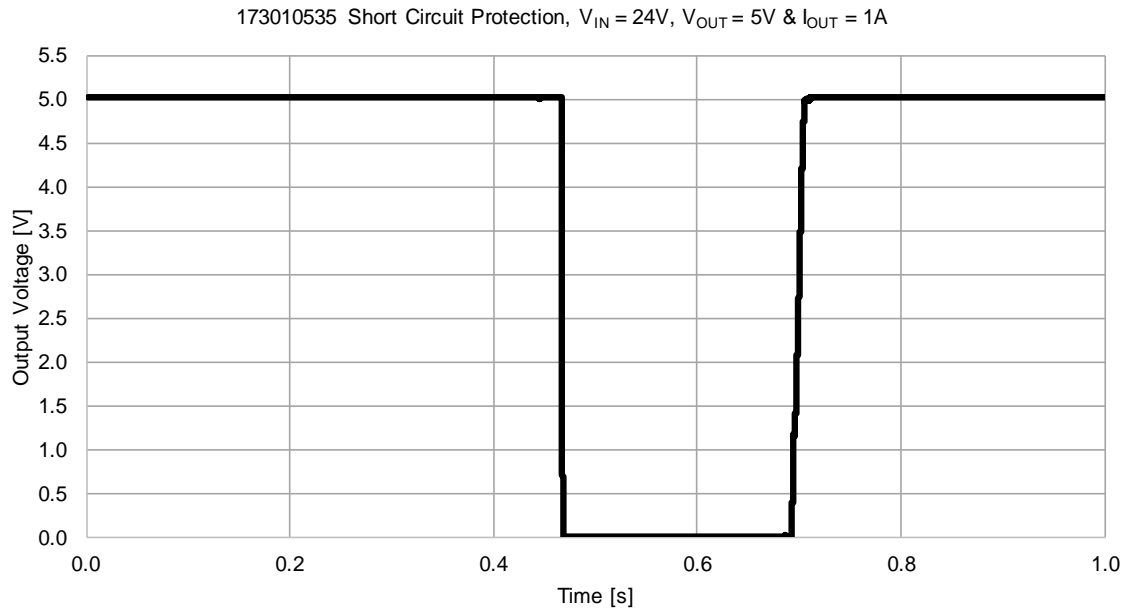

# 173010335, 173010535

## Magl<sup>3</sup>C Power Module FDSM – Fixed Step Down Regulator Module



### Over current protection (OCP)

For protection against load faults, the 173010x35 incorporates cycle-by-cycle current monitoring. During an overcurrent condition the output current is limited and the output voltage drops. When the overcurrent condition is removed, the output voltage returns to the nominal voltage.

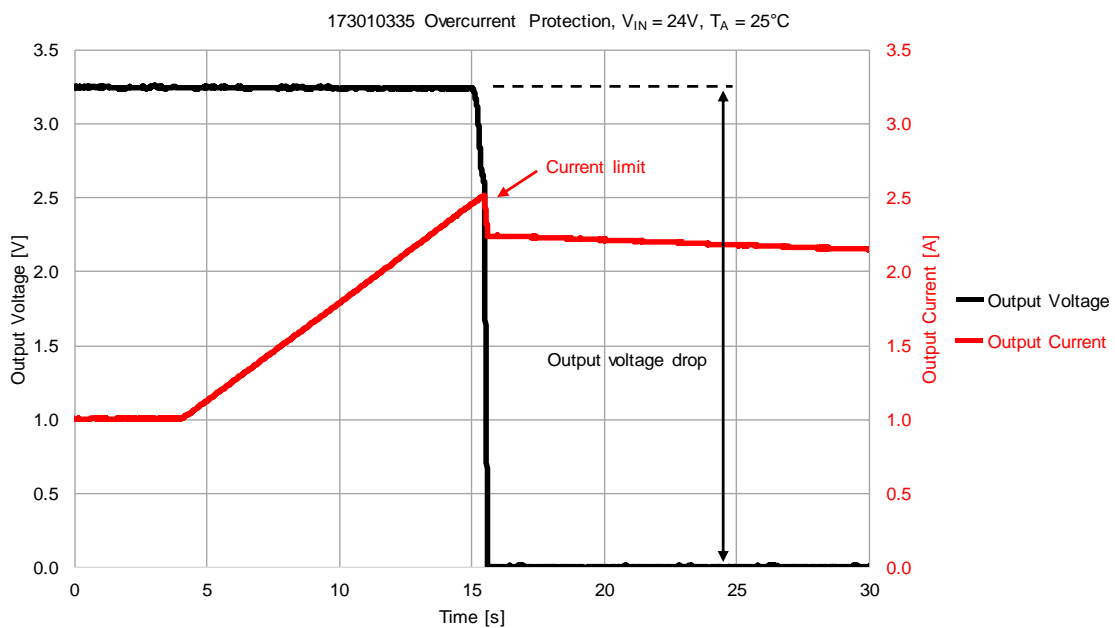
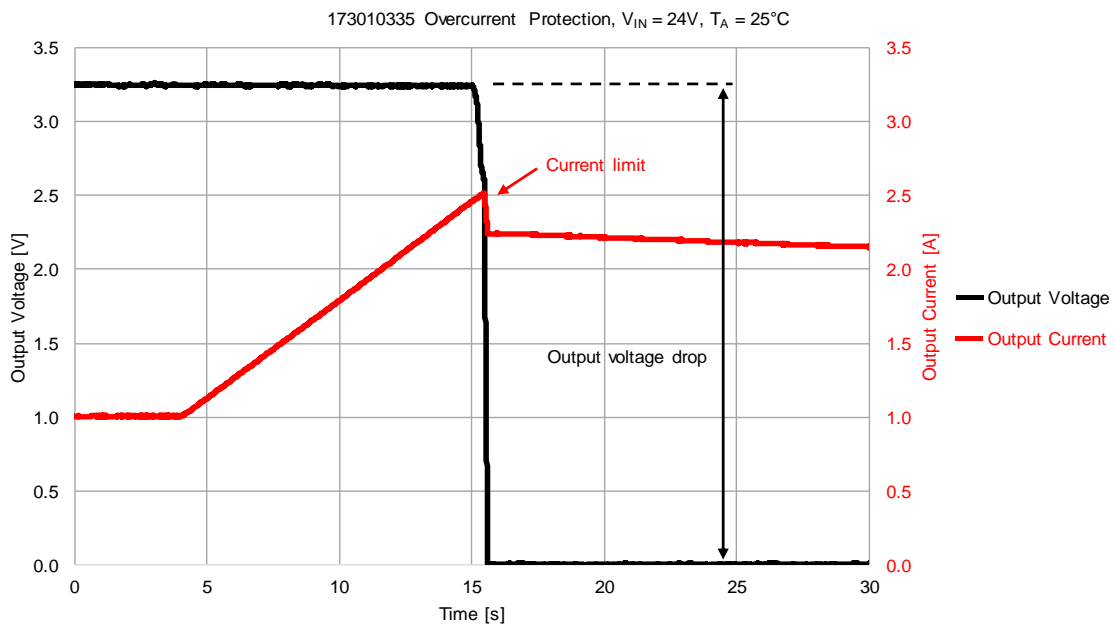

173010335, 173010535

**MagI<sup>3</sup>C** Power Module  
**FDSM** – Fixed Step Down Regulator Module



### EVALUATION BOARD SCHEMATIC (17800FDSM v.1.0)

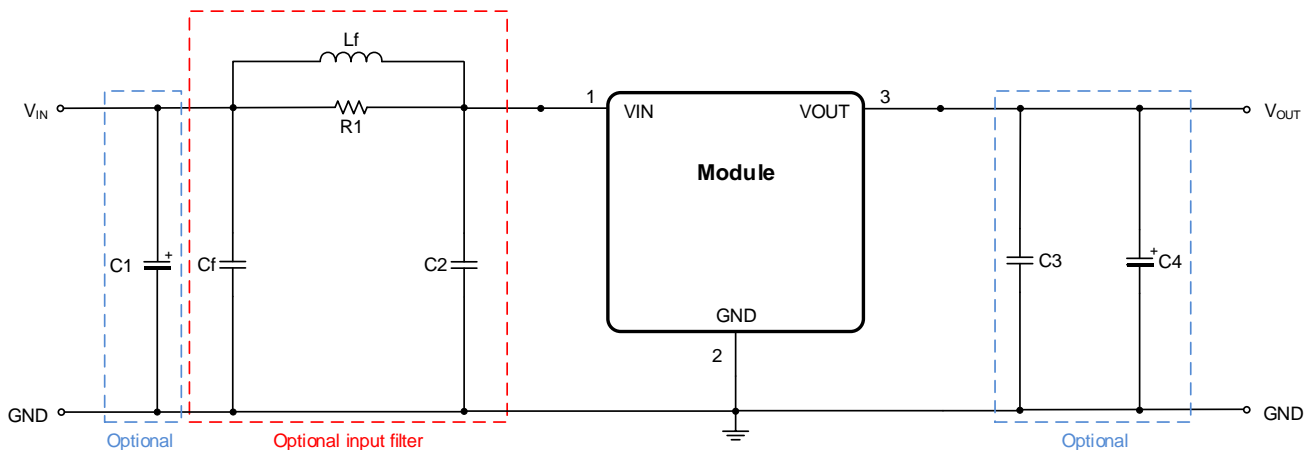

The 173010x35 partially integrates both the input and output capacitors. It is also recommended to use a 10 $\mu$ F input capacitor C2 for high impedance input wires or traces and 22 $\mu$ F output capacitor C3 for applications where a low output voltage ripple is required.

The additional 100 $\mu$ F aluminum electrolytic capacitor C1 is mounted as termination of the supply line and provides a slight damping of possible oscillations of the series resonance circuit represented by the inductance of the supply line and the input capacitance. This capacitor also prevents voltage overshoot during start up.

The additional MLCC  $C_f$  is part of the input filter and is not mounted on the board. The inductor  $L_f$  is not mounted too (see recommended part number in the table below). A zero ohm resistor ( $R_1$ ) is mounted in parallel with  $L_f$ . In case the input filter is placed,  $R_1$  must be removed and an appropriate  $L_f$  mounted.

In case particular application requirements are demanding additional capacitance, the evaluation board gives the possibility to place a further capacitor at the output: C4 (surface mounted electrolytic). This capacitor allows fine tuning of load transient voltage response.

### Bill of Material

Designator	Description	Quantity	Order Code	Manufacturer
IC1	MagI <sup>3</sup> C Power Module (not mounted)	1	173010x35	Würth Elektronik
C1	Aluminum electrolytic capacitor, ATG5 family, 100 $\mu$ F/50V	1	860010674014	Würth Elektronik
C2	Al-Poly capacitor 10 $\mu$ F/63V (not mounted)	optional	875115852001	Würth Elektronik
C3	Ceramic chip capacitor (not mounted)	optional		Würth Elektronik
C4	Surface mounted electrolytic, WCAP-PSLP 220 $\mu$ F/10V	1	875105244013	Würth Elektronik
$C_f$	Al-Poly capacitor 10 $\mu$ F/63V (not mounted)	optional	875115852001	Würth Elektronik
$L_f$	Filter inductor, 1 $\mu$ H, PD2 (not mounted)	optional	7447730	Würth Elektronik
R1	SMD bridge 0 $\Omega$ resistance	1		

173010335, 173010535

**MagI<sup>3</sup>C** Power Module  
**FDSM** – Fixed Step Down Regulator Module



### Filter suggestion for conducted EMI

The input filter shown in the schematic below is recommended to achieve conducted compliance according to EN55032 CISPR32 Class B (see results on page 7).

For radiated EMI the input filter is not necessary. It is only used to comply with the setup recommended in the norms.

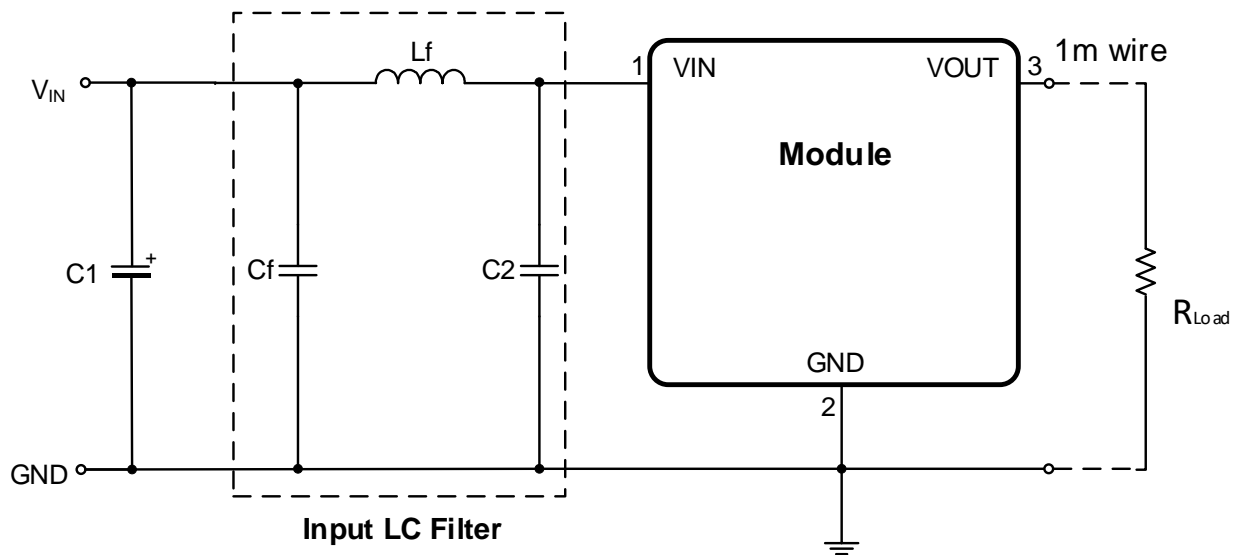

### Bill of Material of the Input LC Filter ( $V_{IN} = 24V$ , $V_{OUT} = 3.3V$ & $5V$ , $I_{OUT} = 1A$ )

Designator	Description	Order Code	Manufacturer
C <sub>2</sub>	Al-Poly capacitor 10 $\mu$ F/63V	875115852001	Würth Elektronik
C <sub>f</sub>	Filter Al-Poly capacitor 10 $\mu$ F/63V	875115852001	Würth Elektronik
L <sub>f</sub>	Filter inductor, 1 $\mu$ H, PD2 family, $I_{SAT} = 5.72A$ , $I_R = 4A$	7447730	Würth Elektronik

# 173010335, 173010535

## MagI<sup>3</sup>C Power Module FDSM – Fixed Step Down Regulator Module



### Generating negative output voltage

Many industrial applications require negative voltages. The 173010x35 can easily provide a negative voltage using the circuit shown below. For low output voltage ripple, it is recommended to use an additional 22µF external capacitor at the output of the module.

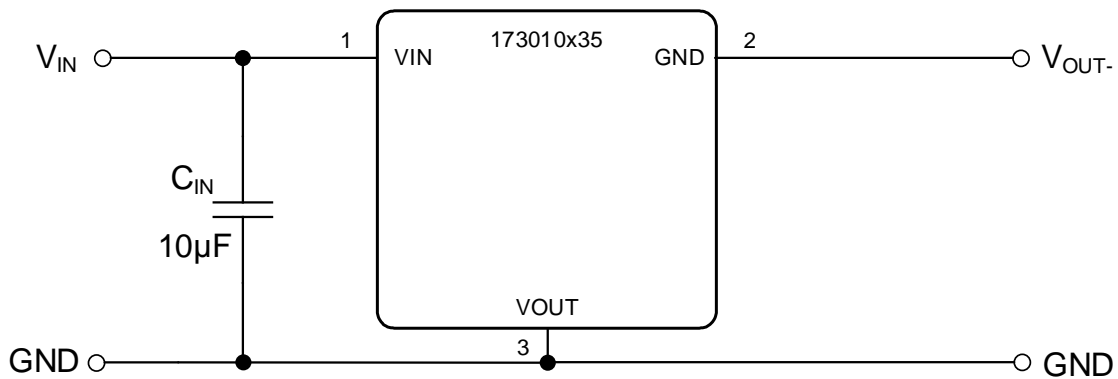

It is important to be aware that in this configuration the 173010x35 must withstand the sum of the input voltage and the absolute value of the output voltage ( $V_{IN} + |V_{OUT}|$ ), instead of just the input voltage. This means that the maximum operating voltage should be limited to  $36V - |V_{OUT}|$  (e.g. if the 171950536 is used in this configuration, the input voltage should not exceed 31V). Moreover, the maximum output current of this configuration is no longer 1A, instead it must be reduced according to the below mentioned formula (see also the graph below):

$$I_{OUT-} = (1 - D) \cdot I_{OUT} \quad (1)$$

where D is the duty cycle, in this case defined according to:

$$D = \frac{|V_{OUT}|}{V_{IN} + |V_{OUT}|} \quad (2)$$

### Starting Condition for generating negative output voltage:

$$V_{IN\_MIN} = 6V (3.3V_{OUT}) \ \& \ 8V (5 V_{OUT})$$

173010335, 173010535

**MagI<sup>3</sup>C** Power Module  
**FDSM** – Fixed Step Down Regulator Module

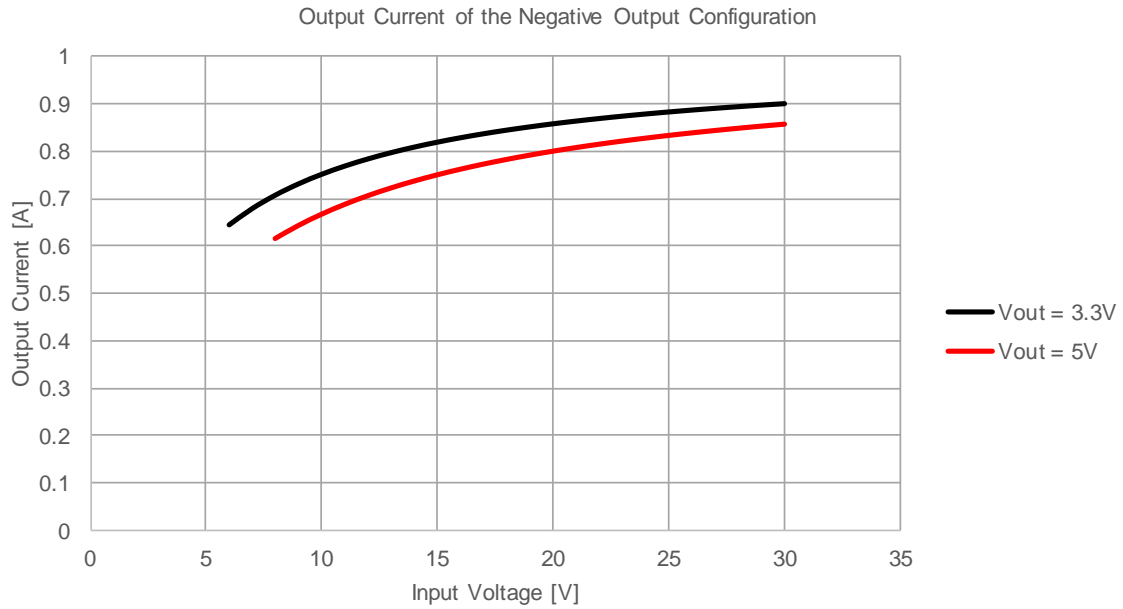

Compared with a standard positive buck configuration, the negative output buck contains an additional critical loop (between  $V_{IN}$  and  $V_{OUT}$ ), which needs an additional capacitor  $C_{IN}$ , as shown in the circuit above.

## 173010335, 173010535

**MagI<sup>3</sup>C** Power Module  
**FDSM** – Fixed Step Down Regulator Module



### Generating complementary output voltage

Another common requirement in industrial application is to provide a complementary voltage (e.g.  $\pm 5V$ ). The circuit below shows how this target can be achieved simply combining a 173010x35 used in a standard configuration (delivering a positive output voltage) with the above mentioned solution for negative voltages. For low output voltage ripple, it is recommended to use an additional  $22\mu F$  external capacitor at the output of the module.

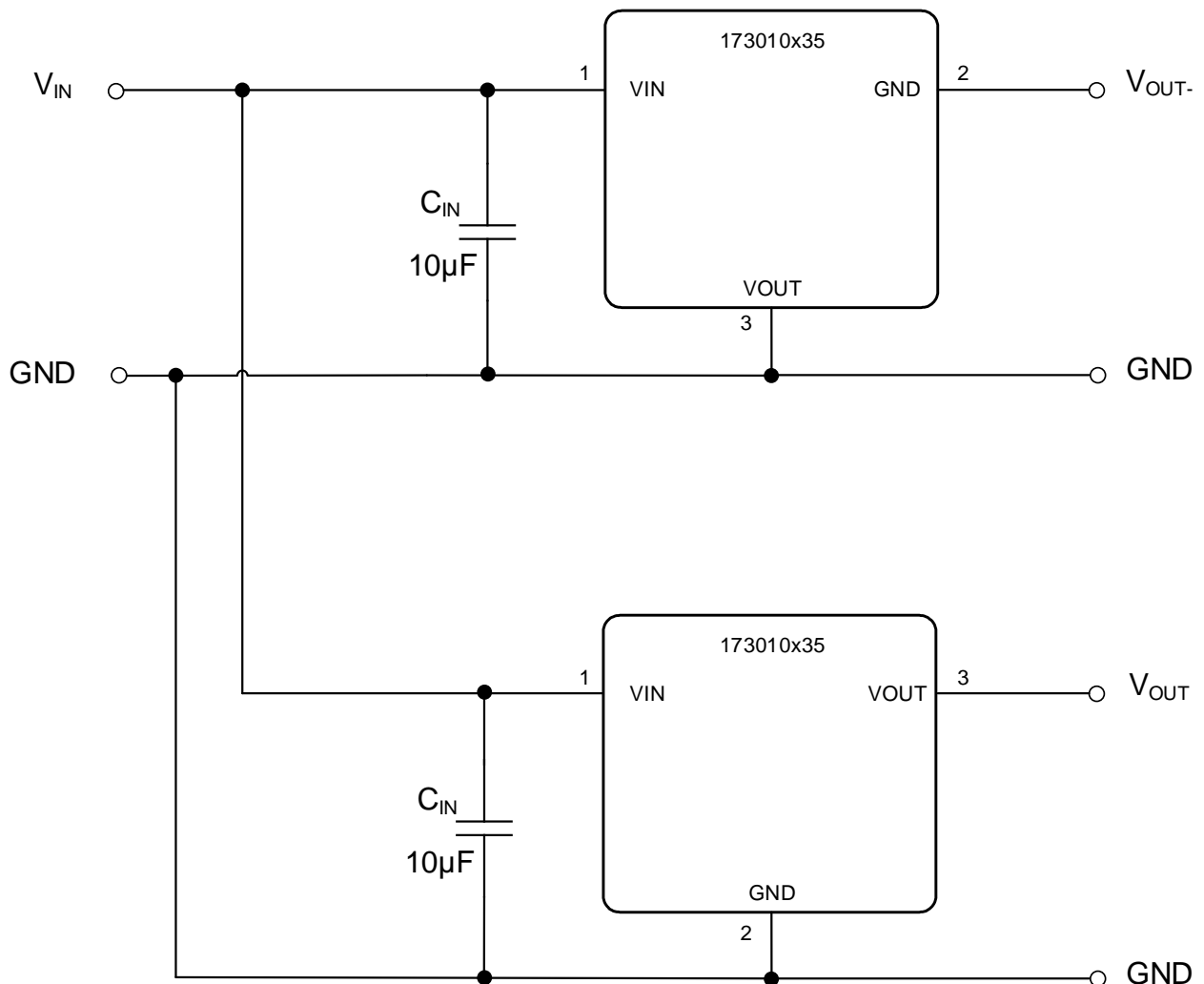

**Complementary output voltage**

173010335, 173010535

**MagI<sup>3</sup>C** Power Module  
**FDSM** – Fixed Step Down Regulator Module



**WAVE SOLDER PROFILE**

Profile Feature	Old standard (Pb)	New (Pb-free)
Time within peak temperature $t_p$	10 s	10 s
Average ramp-up rate	~ 200 °C/s	~ 200 °C/s
Final preheat temperature $T_s$	~ 130 °C	~ 130 °C
Peak temperature $T_P$	+ 235 °C	+ 260 °C
Ramp-down rate	-5 °C/s	-5 °C/s
Heating rate during preheat	4 °C/s	4 °C/s

**Wave Solder Diagram:**

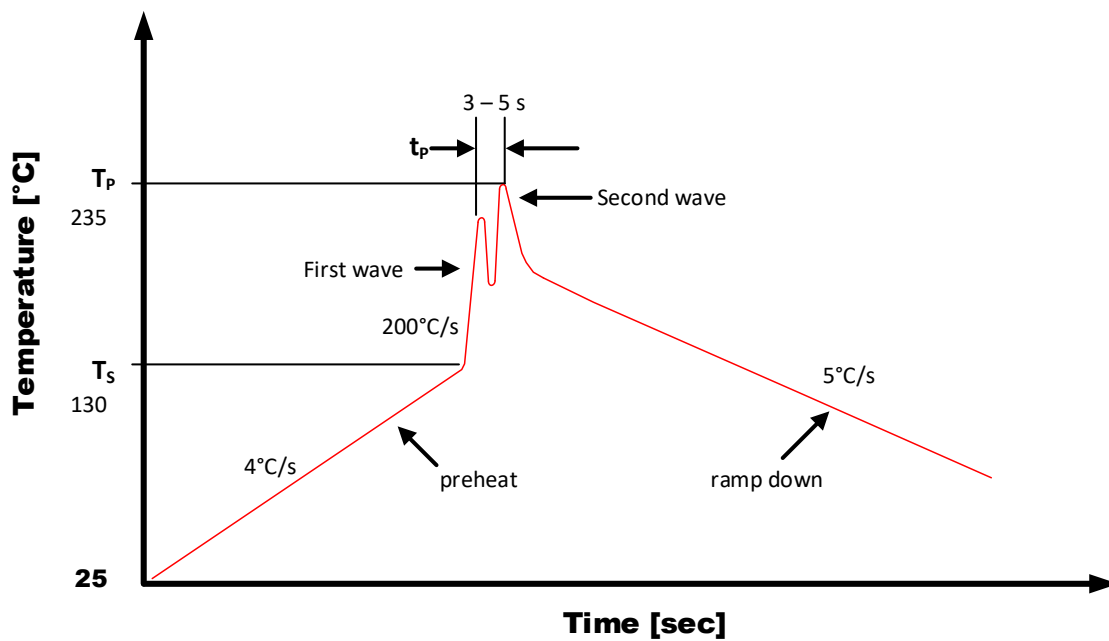



173010335, 173010535

**MagI<sup>3</sup>C** Power Module  
**FDSM** – Fixed Step Down Regulator Module



**PHYSICAL DIMENSIONS**

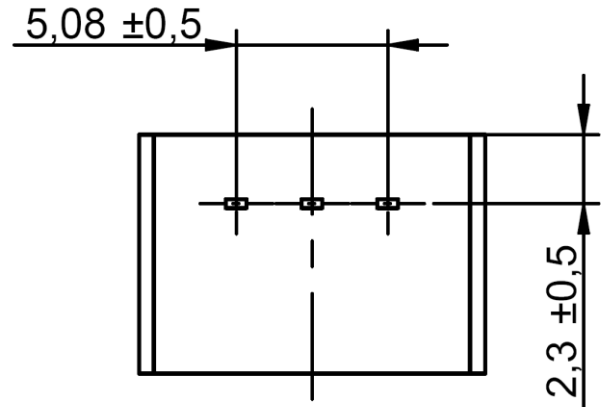
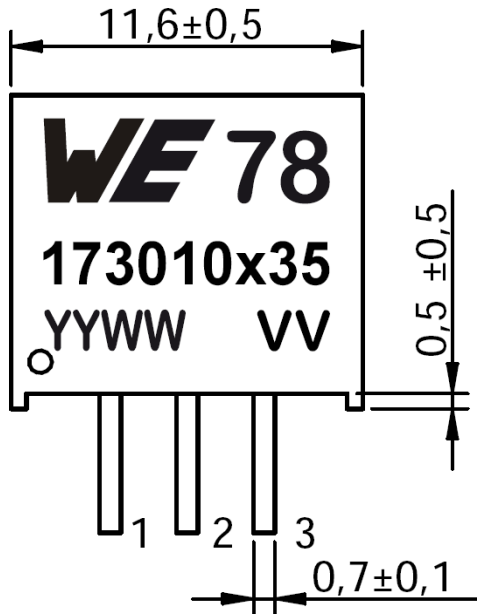

**RECOMMENDED DRILL HOLES**

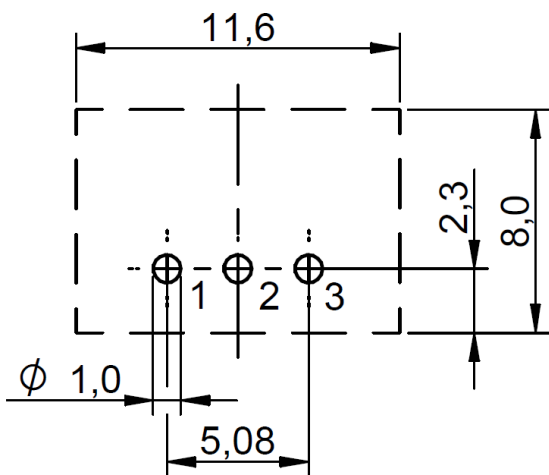

**TUBE**

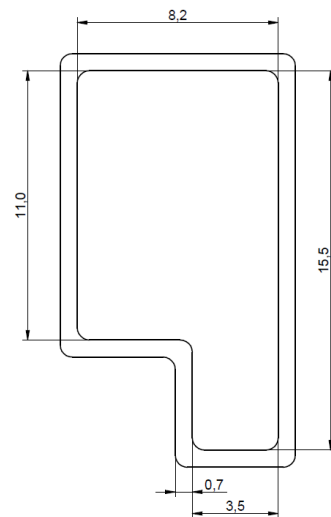

all dimensions in mm

**173010335, 173010535****MagI<sup>3</sup>C** Power Module  
**FDSM** – Fixed Step Down Regulator Module**DOCUMENT HISTORY**

Revision	Date	Description	Comment
1.0	November 2019	Final version	

173010335, 173010535

**MagI<sup>3</sup>C** Power Module  
**FDSM** – Fixed Step Down Regulator Module



**CAUTIONS AND WARNINGS**

The following conditions apply to all goods within the product series of MagI<sup>3</sup>C of Würth Elektronik eiSos GmbH & Co. KG:

**General:**

- All recommendations according to the general technical specifications of the data-sheet have to be complied with.
- The usage and operation of the product within ambient conditions which probably alloy or harm the component surface has to be avoided.
- Electronic components that will be used in safety-critical or high-reliability applications, should be pre-evaluated by the customer.
- The component is designed and manufactured to be used within the datasheet specified values. If the usage and operation conditions specified in the datasheet are not met, the component may be damaged or dissolved.
- Do not drop or impact the components as material of the body, pins or termination may flake apart.
- Würth Elektronik products are qualified according to international standards, which are listed in each product reliability report. Würth Elektronik does not warrant any customer qualified product characteristics beyond Würth Elektronik's specifications, for its validity and sustainability over time.
- The responsibility for the applicability of the customer specific products and use in a particular customer design is always within the authority of the customer. All technical specifications for standard products also apply to customer specific products.
- Customer acknowledges and agrees that it is solely responsible for compliance with all legal, regulatory and safety-related requirements concerning its products, and any use of Würth Elektronik eiSos GmbH & Co. KG components in its applications, notwithstanding any applications-related information or support that may be provided by Würth Elektronik eiSos GmbH & Co. KG. Customer represents and agrees that it has all the necessary expertise to create and implement safeguards which anticipate dangerous consequences of failures, monitor failures and their consequences lessen the likelihood of failures that might cause harm and take appropriate remedial actions. Customer will fully indemnify Würth Elektronik eiSos and its representatives against any damages arising out of the use of any Würth Elektronik eiSos GmbH & Co. KG components in safety-critical applications.

**Product specific:**

Follow all instructions mentioned in the datasheet, especially:

- The solder profile has to comply with the technical reflow or wave soldering specification, otherwise this will void the warranty.
- All products are supposed to be used before the end of the period of 12 months based on the product date-code.
- Violation of the technical product specifications such as exceeding the absolute maximum ratings will void the warranty.
- It is also recommended to return the body to the original moisture proof bag and reseal the moisture proof bag again.
- ESD prevention methods need to be followed for manual handling and processing by machinery.
- Residual washing varnish agent that is used during the production to clean the application might change the characteristics of the body, pins or termination. The washing varnish agent could have a negative effect on the long term function of the product.
- Direct mechanical impact to the product shall be prevented as the material of the body, pins or termination could flake or in the worst case it could break. As these devices are sensitive to electrostatic discharge customer shall follow proper IC Handling Procedures.

**DISCLAIMER**

This electronic component has been designed and developed for usage in general electronic equipment only. This product is not authorized for use in equipment where a higher safety standard and reliability standard is especially required or where a failure of the product is reasonably expected to cause severe personal injury or death, unless the parties have executed an agreement specifically governing such use.

Moreover Würth Elektronik eiSos GmbH & Co KG products are neither designed nor intended for use in areas such as military, aerospace, aviation, nuclear control, submarine, transportation (automotive control, train control, ship control), transportation signal, disaster prevention, medical, public information network etc.. Würth Elektronik eiSos GmbH & Co KG must be informed about the intent of such usage before the design-in stage. In addition, sufficient reliability evaluation checks for safety must be performed on every electronic component which is used in electrical circuits that require high safety and reliability functions or performance.

These cautions and warnings comply with the state of the scientific and technical knowledge and are believed to be accurate and reliable. However, no responsibility is assumed for inaccuracies or incompleteness.

173010335, 173010535

## Magl<sup>3</sup>C Power Module

### FDSM – Fixed Step Down Regulator Module



#### IMPORTANT NOTES

The following conditions apply to all goods within the product range of Würth Elektronik eiSos GmbH & Co. KG:

##### 1. General Customer Responsibility

Some goods within the product range of Würth Elektronik eiSos GmbH & Co. KG contain statements regarding general suitability for certain application areas. These statements about suitability are based on our knowledge and experience of typical requirements concerning the areas, serve as general guidance and cannot be estimated as binding statements about the suitability for a customer application. The responsibility for the applicability and use in a particular customer design is always solely within the authority of the customer. Due to this fact it is up to the customer to evaluate, where appropriate to investigate and decide whether the device with the specific product characteristics described in the product specification is valid and suitable for the respective customer application or not. Accordingly, the customer is cautioned to verify that the datasheet is current before placing orders.

##### 2. Customer Responsibility related to Specific, in particular Safety-Relevant Applications

It has to be clearly pointed out that the possibility of a malfunction of electronic components or failure before the end of the usual lifetime cannot be completely eliminated in the current state of the art, even if the products are operated within the range of the specifications. In certain customer applications requiring a very high level of safety and especially in customer applications in which the malfunction or failure of an electronic component could endanger human life or health it must be ensured by most advanced technological aid of suitable design of the customer application that no injury or damage is caused to third parties in the event of malfunction or failure of an electronic component.

##### 3. Best Care and Attention

Any product-specific notes, warnings and cautions must be strictly observed. Any disregard will result in the loss of warranty.

##### 4. Customer Support for Product Specifications

Some products within the product range may contain substances which are subject to restrictions in certain jurisdictions in order to serve specific technical requirements. Necessary information is available on request. In this case the field sales engineer or the internal sales person in charge should be contacted who will be happy to support in this matter.

##### 5. Product R&D

Due to constant product improvement product specifications may change from time to time. As a standard reporting procedure of the Product Change Notification (PCN) according to the JEDEC-Standard we inform about minor and major changes. In case of further queries regarding the PCN, the field sales engineer or the internal sales person in charge should be contacted. The basic responsibility of the customer as per Section 1 and 2 remains unaffected.

##### 6. Product Life Cycle

Due to technical progress and economical evaluation we also reserve the right to discontinue production and delivery of products. As a standard reporting procedure of the Product Termination Notification (PTN) according to the JEDEC-Standard we will inform at an early stage about inevitable product discontinuance. According to this we cannot guarantee that all products within our product range will always be available. Therefore it needs to be verified with the field sales engineer or the internal sales person in charge about the current product availability expectancy before or when the product for application design-in disposal is considered. The approach named above does not apply in the case of individual agreements deviating from the foregoing for customer-specific products.

##### 7. Property Rights

All the rights for contractual products produced by Würth Elektronik eiSos GmbH & Co. KG on the basis of ideas, development contracts as well as models or templates that are subject to copyright, patent or commercial protection supplied to the customer will remain with Würth Elektronik eiSos GmbH & Co. KG. Würth Elektronik eiSos GmbH & Co. KG does not warrant or represent that any license, either expressed or implied, is granted under any patent right, copyright, mask work right, or other intellectual property right relating to any combination, application, or process in which Würth Elektronik eiSos GmbH & Co. KG components or services are used.

##### 8. General Terms and Conditions

Unless otherwise agreed in individual contracts, all orders are subject to the current version of the "General Terms and Conditions of Würth Elektronik eiSos Group", last version available at [www.we-online.com](http://www.we-online.com).

# Mouser Electronics

Authorized Distributor

Click to View Pricing, Inventory, Delivery & Lifecycle Information:

[Wurth Elektronik:](#)

[173010535](#)