

3 Amp Low Dropout Positive Voltage Regulator

The PJ1085 Series of high performance positive voltage Regulators are designed for use in applications requiring low dropout performance at full rated current, Additionally, the PJ1085 Series provides excellent regulation over variations due to changes in line, load and temperature. Outstanding features include low dropout performance at rated current, fast transient response, internal current limiting and thermal shutdown protection of the output device. The PJ1085 Series are three terminal regulators with fixed and adjustable voltage options available in popular packages.

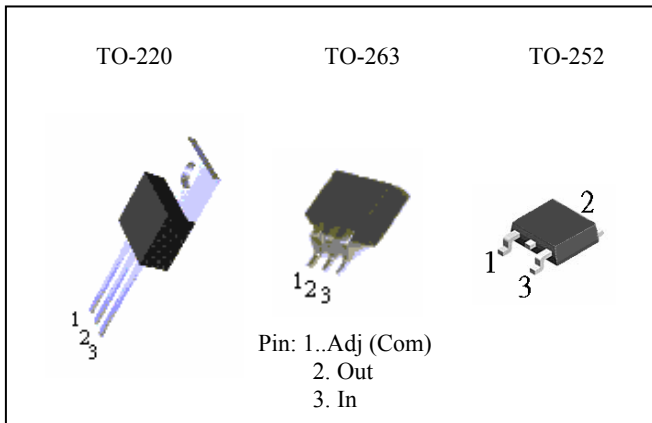

FEATURES

- Low dropout voltage 1.3V max.
- Full current rating over line and temperature
- Fast transient response
- Total output regulation $\pm 2\%$ over line, load and temperature
- Adjust pin current max $120 \mu A$ over temperature
- Line regulation typical 0.015%.
- Load regulation typical 0.05%.
- Fixed/adjustable output voltage
- TO-220 & TO-263 & To-252 package

ORDERING INFORMATION

Device	Operating Temperature (Ambient)	Package
PJ1085CZ PJ1085CZ-2.5 PJ1085CZ-3.3	-20°C to +85°C	TO-220
PJ1085CM PJ1085CM-2.5 PJ1085CM-3.3		TO-263
PJ1085CP PJ1085CP-2.5 PJ1085CP-3.3		TO-252

NOTE: Contact factory for additional voltage option.

BLOCK DIAGRAM

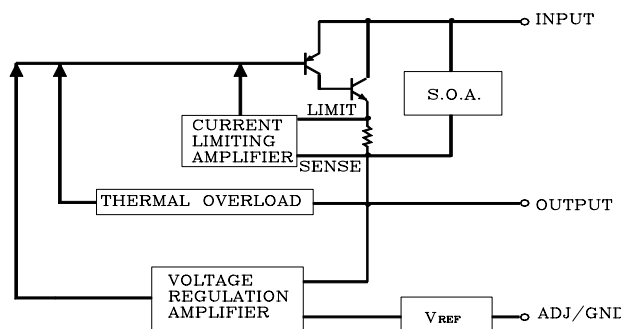

ABSOLUTE MAXIMUM RATING

Parameter	Symbol	Maximum	Units
Input Voltage	V_{IN}	7	V
Power Dissipation	P_D	Internally Limited	W
Thermal Resistance Junction to Case	θ_{JC}	2.5	°C/W
Thermal Resistance Junction to Ambient	θ_{JA}	50	
Operating Junction Temperature Range	T_J	0 to +125	°C
Operating Ambient Temperature Range	T_A	-20 to +85	
Storage Temperature Range	T_{STG}	-25 to 150	
Lead Temperature (Soldering) 10 Sec.	T_{LEAD}	260	

3 Amp Low Dropout Positive Voltage Regulator

ELECTRICAL CHARACTERISTICS

Unless otherwise specified, Adjust $V_{IN} = 2.75V$ to $12V$ and Adjust $I_o = 10mA$ to $3.0A$

Fixed $V_{IN} = 4.75V$ to $12V$ and Fixed $I_o = 10mA$ to $3.0A$

Parameter	Symbol	Test Conditions			Test Limits			Units
		$V_{IN} - V_{OUT}$	I_o	$T_J^{(4)}$	Min	Typ	Max	
Output Voltage ⁽¹⁾	V_o	5V	10mA	25	0.99 V _o	V_o	1.01 V _o	V
Fixed Voltage				Over Temp.	0.98 V _o		1.02 V _o	
Reference Voltage ⁽¹⁾	V_{REF}	5V	10mA	25	1.238	1.250	1.262	
Adj Voltage				Over Temp.	1.225		1.275	
Line Regulation ⁽¹⁾	$REG_{(LINE)}$		10mA	25		0.015	0.2	%
($V_{in} - V_{out} = 3V$)				Over Temp.				
Load Regulation ⁽¹⁾	$REG_{(LOAD)}$			25		0.05	0.3	
($V_{in} - V_{out} = 3V$)				Over Temp.				
Dropout Voltage	V_D			25		1		V
$\Delta V_{REF} = 1\%$				Over Temp.		1.1		
Current Limit	I_{CL}				3.2	4.0		A
($V_{in} - V_{out} = 5V$)								
Quiescent Current	I_Q	5V				12	14	mA
Fixed Model								
Temperature Coefficient	T_c					0.005		%/°C
Adjust Pin Current	I_{ADJ}			25		55	120	μA
Adjust Pin Current Change				ΔI_{ADJ}				
Temperature Stability	T_s	5V	500mA	Over Temp.		0.5		%
Minimum Load Current	I_o	5V				5	10	mA
Adjust Model								
RMS Output Noise ⁽²⁾	V_N			25		0.003		%V _o
Ripple Rejection Ratio ⁽³⁾	R_A	5V	3.0A	Over Temp.	60	72		dB

(1)Low duty cycle pulse testing with Kelvin connections required.

(2)Bandwidth of 10Hz to 10KHz.

(3)120Hz input ripple (C_{ADJ} for ADJ)=25 μF .

(4)Over Temp.-over specified operating junction temperature range.

3 Amp Low Dropout Positive Voltage Regulator

Typical Application Circuit

FIXED VOLTAGE REGULATOR (1)(2)

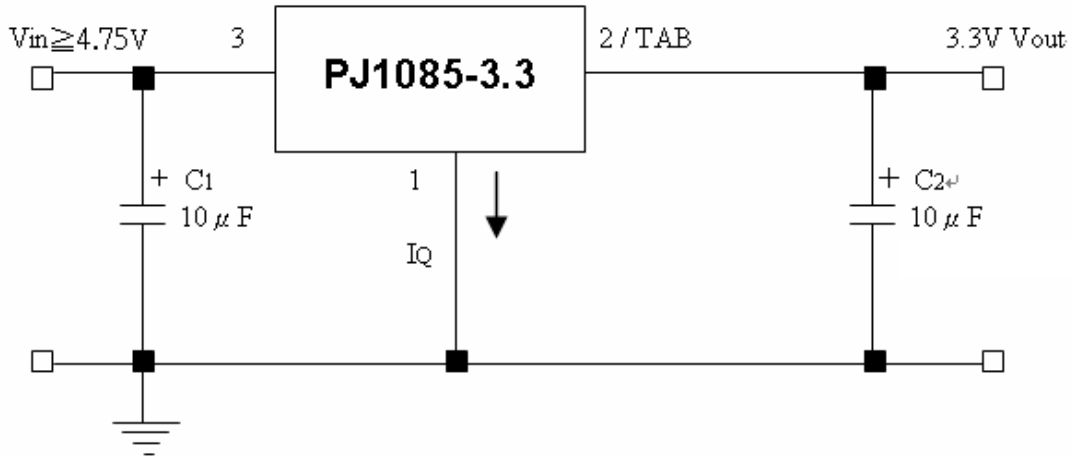

- (1) C1 NEEDED IF DEVICE IS FAR FROM FILTER CAPACITORS
- (2) C2 REQUIRED FOR STABILITY

ADJUSTABLE VOLTAGE REGULATOR (1)(2)

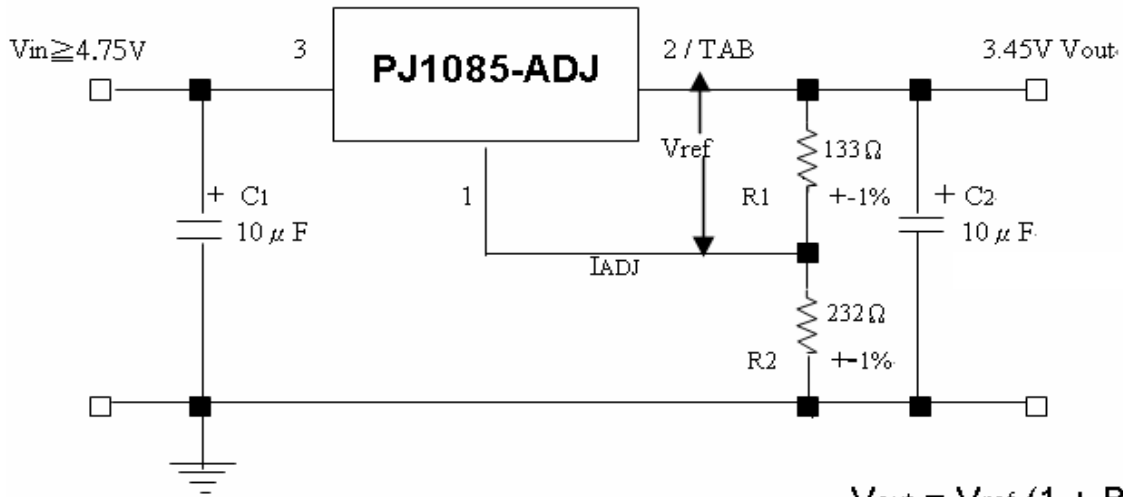

$$V_{out} = V_{ref} (1 + R2/R1) + I_{adj}R2$$

- (1) C1 NEEDED IF DEVICE IS FAR FROM FILTER CAPACITORS
- (2) C2 REQUIRED FOR STABILITY

3 Amp Low Dropout Positive Voltage Regulator

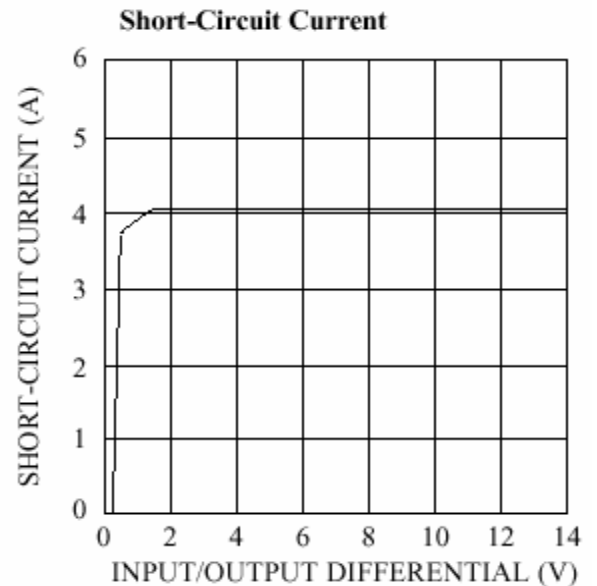
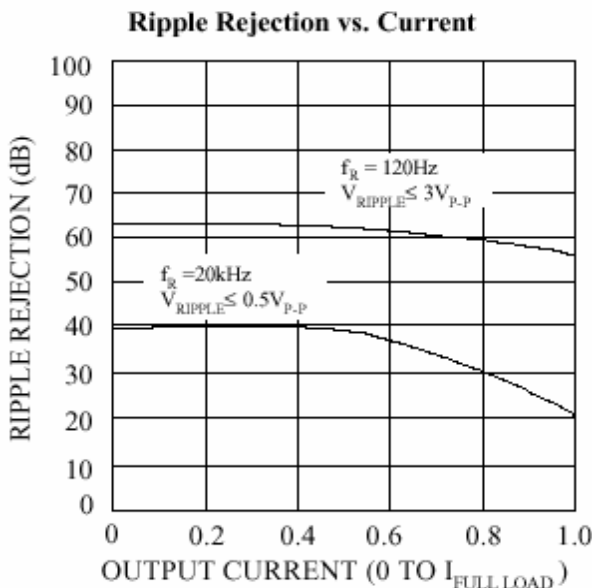
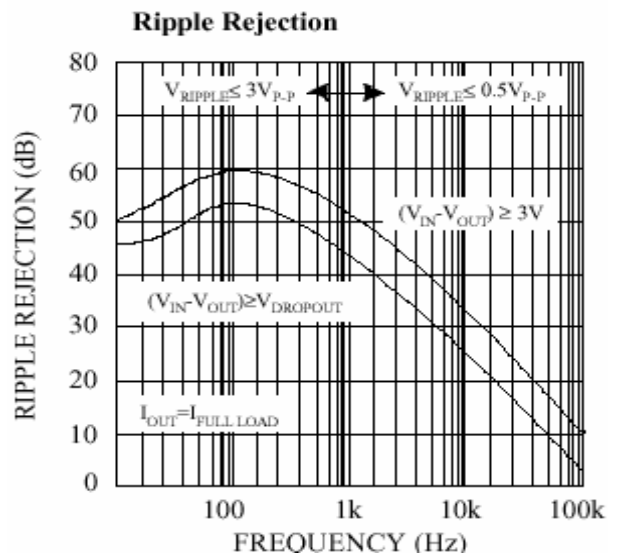
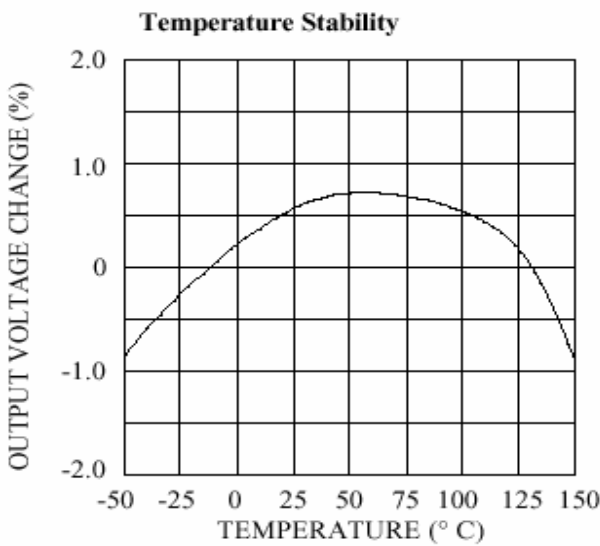
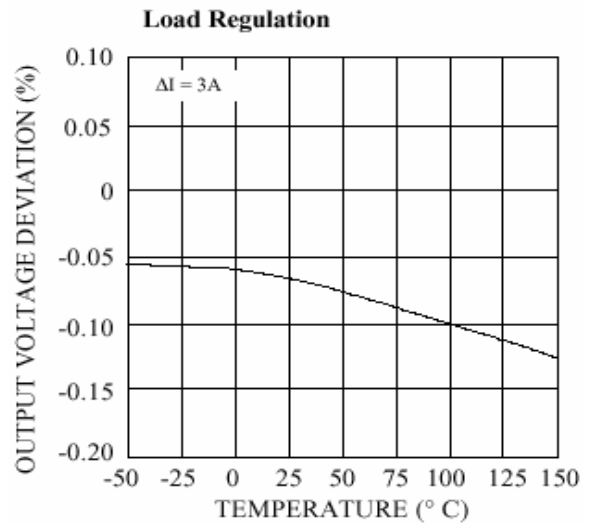
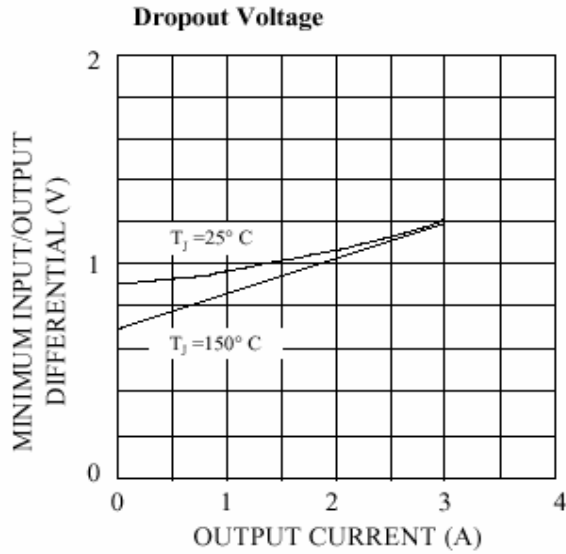

3 Amp Low Dropout Positive Voltage Regulator

Load Transient Response

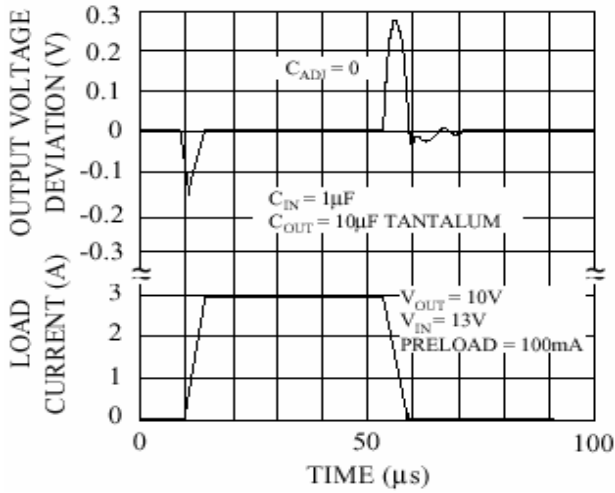

Line Transient Response

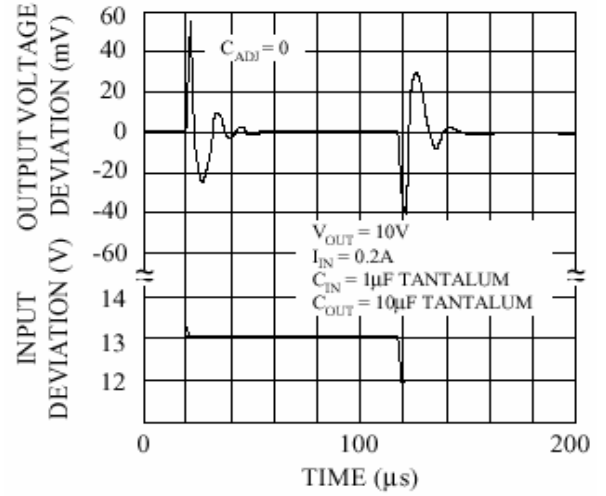

Maximum Power Dissipation*

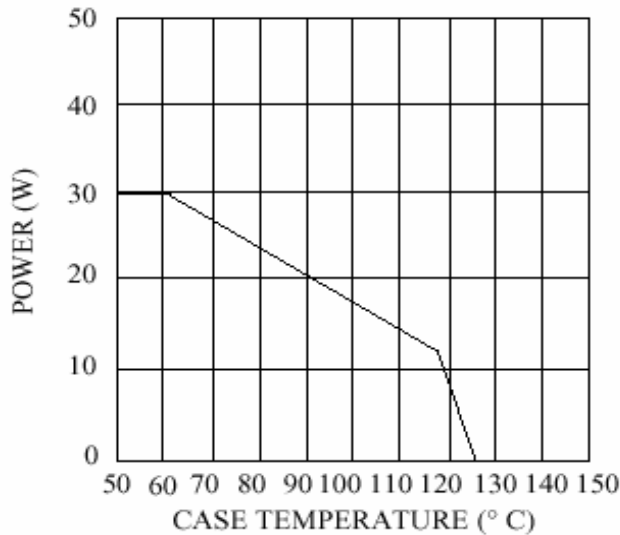

*AS LIMITED BY MAXIMUM JUNCTION TEMPERATURE

Minimum Operating Current
(Adjustable only)

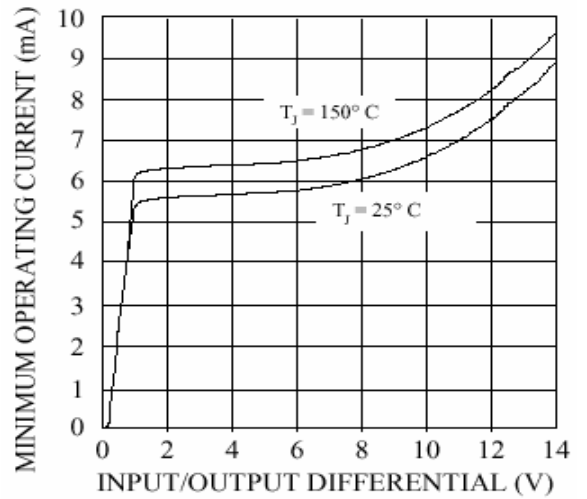

Adjust Pin Current
(Adjustable only)

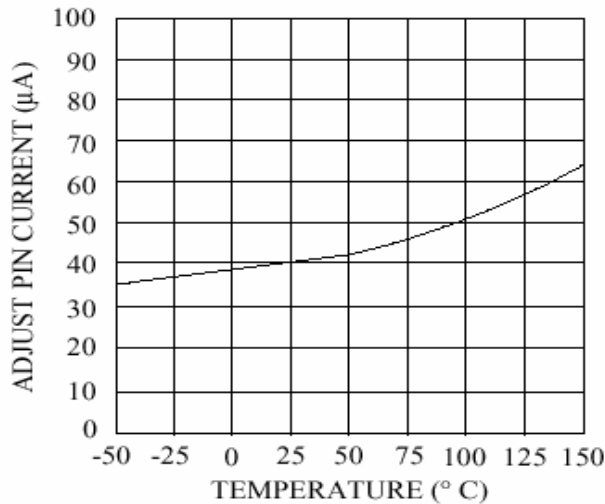

3 Amp Low Dropout Positive Voltage Regulator

TO-220 Mechanical drawing

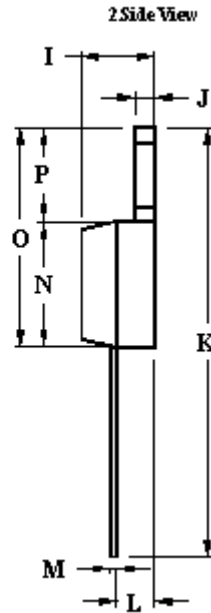
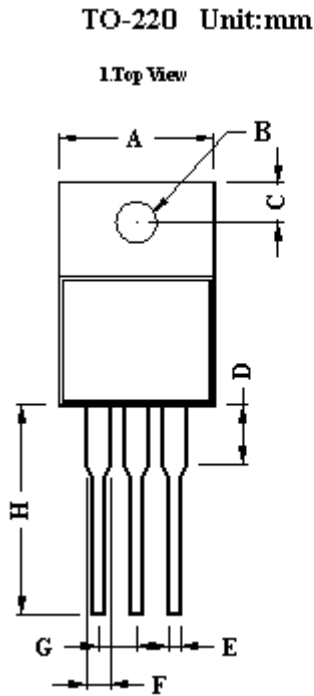

TO-220 DIMENSION				
DIM	MILLIMETERS		INCHES	
	MIN	MAX	MIN	MAX
A	10.00	10.50	0.394	0.413
B	3.24	4.44	0.128	0.175
C	2.44	2.94	0.096	0.116
D	3.565	4.315	0.140	0.170
E	0.68	0.92	0.027	0.036
F	1.115	1.485	0.044	0.058
G	2.345	2.715	0.092	0.107
H	13.49	14.31	0.531	0.563
I	4.475	5.225	0.176	0.206
J	1.15	1.39	0.045	0.055
K	27.78	29.62	1.094	1.166
L	2.175	2.925	0.086	0.115
M	0.297	0.477	0.012	0.019
N	8.28	8.80	0.326	0.346
O	14.29	15.31	0.563	0.603
P	6.01	6.51	0.237	0.256

TO-263 Mechanical drawing

TO-263 Unit:mm

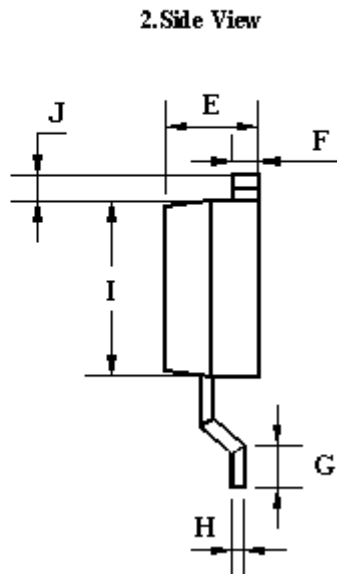
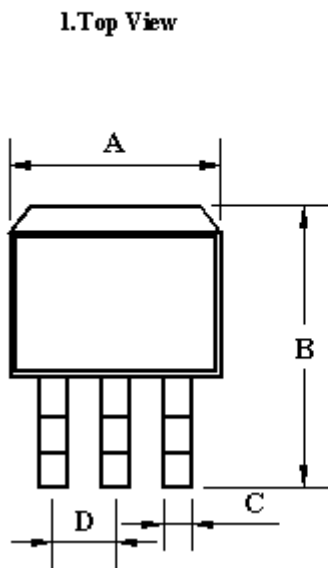

TO-263 DIMENSION				
DIM	MILLIMETERS		INCHES	
	MIN	MAX	MIN	MAX
A	10.00	10.50	0.394	0.413
B	14.60	15.87	0.575	0.625
C	0.68	0.92	0.027	0.036
D	2.42	2.66	0.095	0.105
E	4.31	4.83	0.170	0.190
F	1.14	1.40	0.045	0.055
G	2.28	2.79	0.090	0.110
H	0.45	0.73	0.018	0.029
I	8.28	8.80	0.326	0.346
J	1.14	1.4	0.045	0.055

3 Amp Low Dropout Positive Voltage Regulator

TO-252 Mechanical drawing

1.Top View

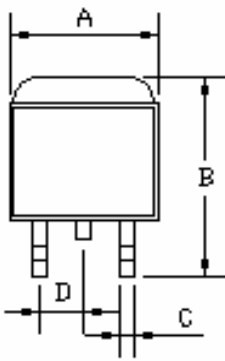

2.Side View

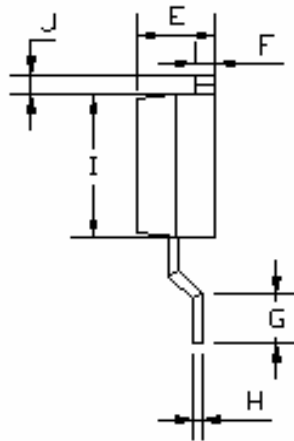

DIM	TO-252 DIMENSION			
	MILLIMETERS		INCHES	
	MIN	MAX	MIN	MAX
A	6.57	6.84	0.259	0.269
B	9.25	10.40	0.364	0.409
C	0.62	0.76	0.024	0.030
D	2.56	2.67	0.101	0.105
E	2.30	2.39	0.090	0.094
F	0.49	0.57	0.019	0.022
G	1.46	1.58	0.057	0.062
H	0.52	0.57	0.020	0.022
I	5.34	5.55	0.210	0.219
J	1.46	1.64	0.057	0.065