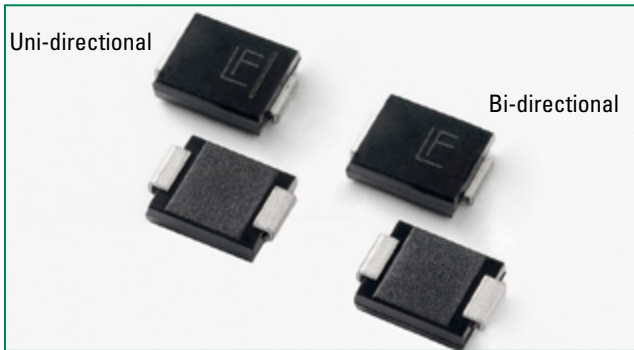



### SMCJ Series



#### Agency Approvals

AGENCY	AGENCY FILE NUMBER
	E230531

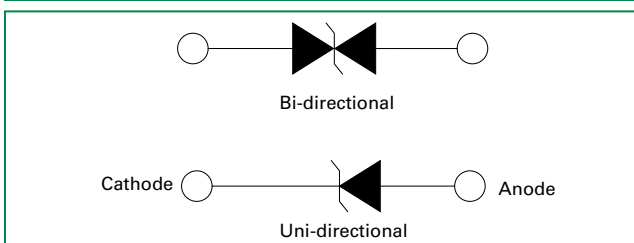
#### Maximum Ratings and Thermal Characteristics (T<sub>A</sub> = 25°C unless otherwise noted)

Parameter	Symbol	Value	Unit
Peak Pulse Power Dissipation at T <sub>A</sub> = 25°C by 10/1000µs Waveform (Fig.2)(Note 1), (Note 2), (Note 5)	P <sub>PPM</sub>	1500	W
Power Dissipation on Infinite Heat Sink at T <sub>L</sub> = 50°C	P <sub>D</sub>	6.5	W
Peak Forward Surge Current, 8.3ms Single Half Sine Wave (Note 3)	I <sub>FSM</sub>	200	A
Maximum Instantaneous Forward Voltage at 100A for Unidirectional Only (Note 4)	V <sub>F</sub>	3.5/5.0	V
Operating Temperature Range	T <sub>J</sub>	-65 to 150	°C
Storage Temperature Range	T <sub>STG</sub>	-65 to 175	°C
Typical Thermal Resistance Junction to Lead	R <sub>θJL</sub>	15	°C/W
Typical Thermal Resistance Junction to Ambient	R <sub>θJA</sub>	75	°C/W

#### Notes:

1. Non-repetitive current pulse, per Fig. 4 and derated above T<sub>J</sub> (initial) = 25°C per Fig. 3.
2. Mounted on copper pad area of 0.31x0.31" (8.0 x 8.0mm) to each terminal.
3. Measured on 8.3ms single half sine wave or equivalent square wave for unidirectional device only, duty cycle=4 per minute maximum.
4. V<sub>F</sub> < 3.5V for single die parts and V<sub>F</sub> < 5.0V for stacked-die parts.
5. The P<sub>PPM</sub> of stacked-die parts is 2000W and please contact littelfuse for the detail stacked-die parts.

#### Functional Diagram



#### Description

The SMCJ series is designed specifically to protect sensitive electronic equipment from voltage transients induced by lightning and other transient voltage events.

#### Features

- 1500W peak pulse power capability at 10/1000µs waveform, repetition rate (duty cycles):0.01 %
- Excellent clamping capability
- Low incremental surge resistance
- Typical I<sub>R</sub> less than 1µA when V<sub>BR</sub> min > 12V
- For surface mounted applications to optimize board space
- Low profile package
- Built-in strain relief
- Typical failure mode is short from over-specified voltage or current
- Whisker test is conducted based on JEDEC JESD201A per its table 4a and 4c
- IEC-61000-4-2 ESD 30kV(Air), 30kV (Contact)
- ESD protection of data lines in accordance with IEC 61000-4-2
- EFT protection of data lines in accordance with IEC 61000-4-4
- Fast response time: typically less than 1.0ps from 0V to BV min
- Glass passivated chip junction
- High temperature to reflow soldering guaranteed: 260°C/40sec
- V<sub>BR</sub> @ T<sub>J</sub> = V<sub>BR</sub> @ 25°C x (1 + α T x (T<sub>J</sub> - 25)) (α T: Temperature Coefficient, typical value is 0.1%)
- Plastic package is flammability rated V-0 per Underwriters Laboratories
- Meet MSL level1, per J-STD-020, LF maximum peak of 260°C
- Matte tin lead-free plated
- Halogen free and RoHS compliant
- Pb-free E3 means 2nd level interconnect is Pb-free and the terminal finish material is tin(Sn) (IPC/JEDEC J-STD-609A.01)

#### Applications

TVS devices are ideal for the protection of I/O Interfaces, V<sub>CC</sub> bus and other vulnerable circuits used in Telecom, Computer, Industrial and Consumer electronic applications.

#### Additional Information



Datasheet




Resources



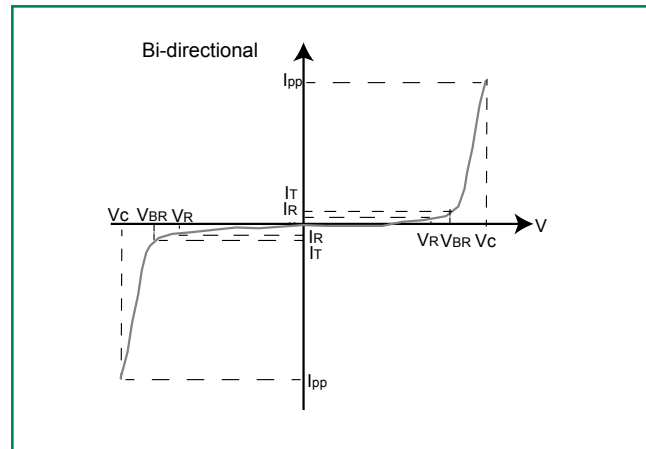
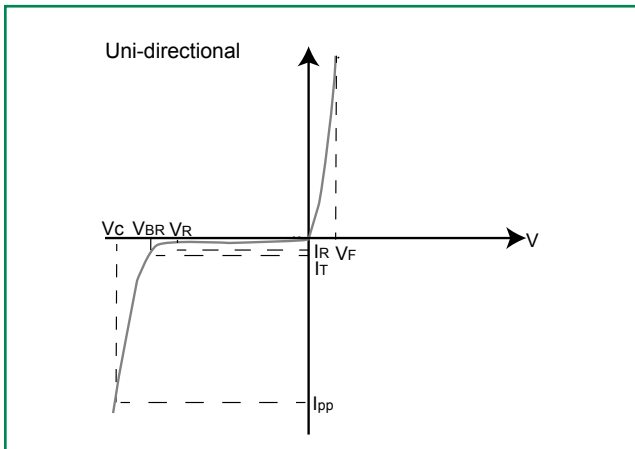
Samples

### Electrical Characteristics (T<sub>A</sub>=25°C unless otherwise noted)

Part Number (Uni)	Part Number (Bi)	Marking		Reverse Stand off Voltage V <sub>R</sub> (Volts)	Breakdown Voltage V <sub>BR</sub> (Volts) @ I <sub>T</sub>		Test Current I <sub>T</sub> (mA)	Maximum Clamping Voltage V <sub>C</sub> @ I <sub>pp</sub> (V)	Maximum Peak Pulse Current I <sub>pp</sub> (A)	Maximum Reverse Leakage I <sub>R</sub> @ V <sub>R</sub> (µA)	Agency Approval 
		UNI	BI		MIN	MAX					
SMCJ5.0A	SMCJ5.0CA	GDE	BDE	5.0	6.40	7.00	10	9.2	163.0	800	X
SMCJ6.0A	SMCJ6.0CA	GDG	BDG	6.0	6.67	7.37	10	10.3	145.7	800	X
SMCJ6.5A	SMCJ6.5CA	GDK	BDK	6.5	7.22	7.98	10	11.2	134.0	500	X
SMCJ7.0A	SMCJ7.0CA	GDM	BDM	7.0	7.78	8.60	10	12.0	125.0	200	X
SMCJ7.5A	SMCJ7.5CA	GDP	BDP	7.5	8.33	9.21	1	12.9	116.3	100	X
SMCJ8.0A	SMCJ8.0CA	GDR	BDR	8.0	8.89	9.83	1	13.6	110.3	50	X
SMCJ8.5A	SMCJ8.5CA	GDT	BDT	8.5	9.44	10.40	1	14.4	104.2	20	X
SMCJ9.0A	SMCJ9.0CA	GDV	BDV	9.0	10.00	11.10	1	15.4	97.4	10	X
SMCJ10A	SMCJ10CA	GDX	BDX	10.0	11.10	12.30	1	17.0	88.3	5	X
SMCJ11A	SMCJ11CA	GDZ	BDZ	11.0	12.20	13.50	1	18.2	82.5	1	X
SMCJ12A	SMCJ12CA	GEE	BEE	12.0	13.30	14.70	1	19.9	75.4	1	X
SMCJ13A	SMCJ13CA	GEG	BEG	13.0	14.40	15.90	1	21.5	69.8	1	X
SMCJ14A	SMCJ14CA	GEK	BEK	14.0	15.60	17.20	1	23.2	64.7	1	X
SMCJ15A	SMCJ15CA	GEM	BEM	15.0	16.70	18.50	1	24.4	61.5	1	X
SMCJ16A	SMCJ16CA	GEP	BEP	16.0	17.80	19.70	1	26.0	57.7	1	X
SMCJ17A	SMCJ17CA	GER	BER	17.0	18.90	20.90	1	27.6	54.4	1	X
SMCJ18A	SMCJ18CA	GET	BET	18.0	20.00	22.10	1	29.2	51.4	1	X
SMCJ20A	SMCJ20CA	GEV	BEV	20.0	22.20	24.50	1	32.4	46.3	1	X
SMCJ22A	SMCJ22CA	GEX	BEX	22.0	24.40	26.90	1	35.5	42.3	1	X
SMCJ24A	SMCJ24CA	GEZ	BEZ	24.0	26.70	29.50	1	38.9	38.6	1	X
SMCJ26A	SMCJ26CA	GFE	BEF	26.0	28.90	31.90	1	42.1	35.7	1	X
SMCJ28A	SMCJ28CA	GFG	BEF	28.0	31.10	34.40	1	45.4	33.1	1	X
SMCJ30A	SMCJ30CA	GFK	BFK	30.0	33.30	36.80	1	48.4	31.0	1	X
SMCJ33A	SMCJ33CA	GFM	BFM	33.0	36.70	40.60	1	53.3	28.2	1	X
SMCJ36A	SMCJ36CA	GFP	BFP	36.0	40.00	44.20	1	58.1	25.9	1	X
SMCJ40A	SMCJ40CA	GFR	BFR	40.0	44.40	49.10	1	64.5	23.3	1	X
SMCJ43A	SMCJ43CA	GFT	BFT	43.0	47.80	52.80	1	69.4	21.7	1	X
SMCJ45A	SMCJ45CA	GFV	BFV	45.0	50.00	55.30	1	72.7	20.6	1	X
SMCJ48A	SMCJ48CA	GFX	BFX	48.0	53.30	58.90	1	77.4	19.4	1	X
SMCJ51A	SMCJ51CA	GFZ	BFZ	51.0	56.70	62.70	1	82.4	18.2	1	X
SMCJ54A	SMCJ54CA	GGE	BGE	54.0	60.00	66.30	1	87.1	17.3	1	X
SMCJ58A	SMCJ58CA	GGG	BGG	58.0	64.40	71.20	1	93.6	16.1	1	X
SMCJ60A	SMCJ60CA	GGK	BGK	60.0	66.70	73.70	1	96.8	15.5	1	X
SMCJ64A	SMCJ64CA	GGM	BGM	64.0	71.10	78.60	1	103.0	14.6	1	X
SMCJ70A	SMCJ70CA	GGP	BGP	70.0	77.80	86.00	1	113.0	13.3	1	X
SMCJ75A	SMCJ75CA	GGR	BGR	75.0	83.30	92.10	1	121.0	12.4	1	X
SMCJ78A	SMCJ78CA	GGT	BGT	78.0	86.70	95.80	1	126.0	11.9	1	X
SMCJ85A	SMCJ85CA	GGV	BGV	85.0	94.40	104.00	1	137.0	11.0	1	X
SMCJ90A	SMCJ90CA	GGX	BGX	90.0	100.00	111.00	1	146.0	10.3	1	X
SMCJ100A	SMCJ100CA	GGZ	BGZ	100.0	111.00	123.00	1	162.0	9.3	1	X
SMCJ110A	SMCJ110CA	GHE	BHE	110.0	122.00	135.00	1	177.0	8.5	1	X
SMCJ120A	SMCJ120CA	GHG	BHG	120.0	133.00	147.00	1	193.0	7.8	1	X
SMCJ130A	SMCJ130CA	GHK	BHK	130.0	144.00	159.00	1	209.0	7.2	1	X
SMCJ150A	SMCJ150CA	GHM	BHM	150.0	167.00	185.00	1	243.0	6.2	1	X
SMCJ160A	SMCJ160CA	GHP	BHP	160.0	178.00	197.00	1	259.0	5.8	1	X
SMCJ170A	SMCJ170CA	GHR	BHR	170.0	189.00	209.00	1	275.0	5.5	1	X
SMCJ180A	SMCJ180CA	GHT	BHT	180.0	201.00	222.00	1	292.0	5.1	1	X
SMCJ200A	SMCJ200CA	GHV	BHV	200.0	224.00	247.00	1	324.0	4.6	1	X
SMCJ220A	SMCJ220CA	GHX	BHX	220.0	246.00	272.00	1	356.0	4.2	1	X
SMCJ250A	SMCJ250CA	GHZ	BHZ	250.0	279.00	309.00	1	405.0	3.7	1	X
SMCJ300A	SMCJ300CA	GJE	BJE	300.0	335.00	371.00	1	486.0	3.1	1	X
SMCJ350A	SMCJ350CA	GJG	BJG	350.0	391.00	432.00	1	567.0	2.6	1	X
SMCJ400A	SMCJ400CA	GJK	BJK	400.0	447.00	494.00	1	648.0	2.3	1	X
SMCJ440A	SMCJ440CA	GJM	BJM	440.0	492.00	543.00	1	713.0	2.1	1	X

For bidirectional type having V<sub>R</sub> of 10 volts and less, the I<sub>R</sub> limit is double.  
 For parts without A, the V<sub>BR</sub> is ± 10% and V<sub>C</sub> is 5% higher than with A parts

### I-V Curve Characteristics



**$P_{PPM}$  Peak Pulse Power Dissipation** – Max power dissipation

**$V_R$  Stand-off Voltage** – Maximum voltage that can be applied to the TVS without operation

**$V_{BR}$  Breakdown Voltage** – Maximum voltage that flows through the TVS at a specified test current ( $I_T$ )

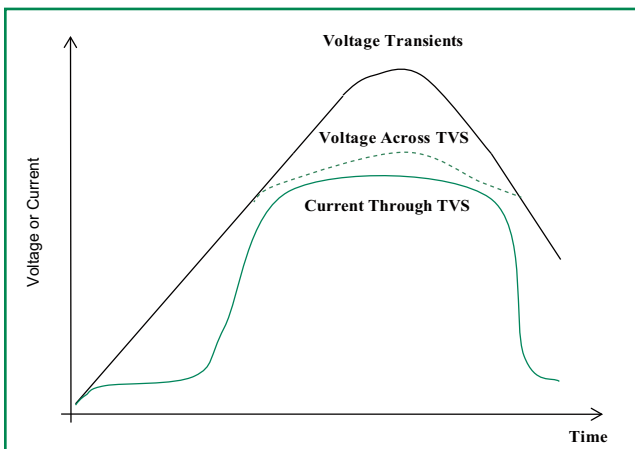
**$V_C$  Clamping Voltage** – Peak voltage measured across the TVS at a specified  $I_{ppm}$  (peak impulse current)

**$I_R$  Reverse Leakage Current** – Current measured at  $V_R$

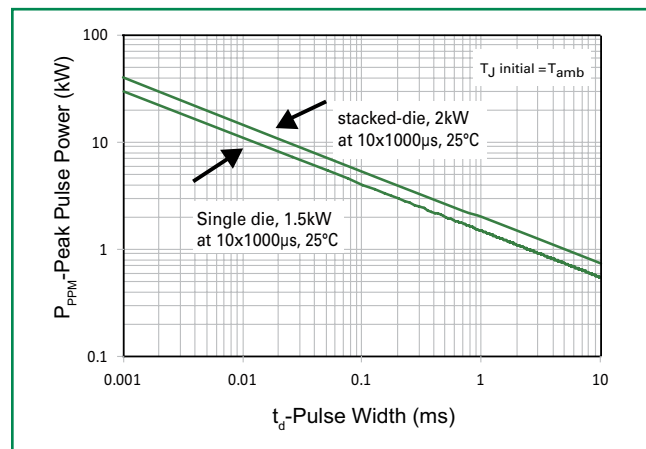
**$V_F$  Forward Voltage Drop for Uni-directional**

### Ratings and Characteristic Curves ( $T_A=25^\circ\text{C}$ unless otherwise noted)

**Figure 1 - TVS Transients Clamping Waveform**



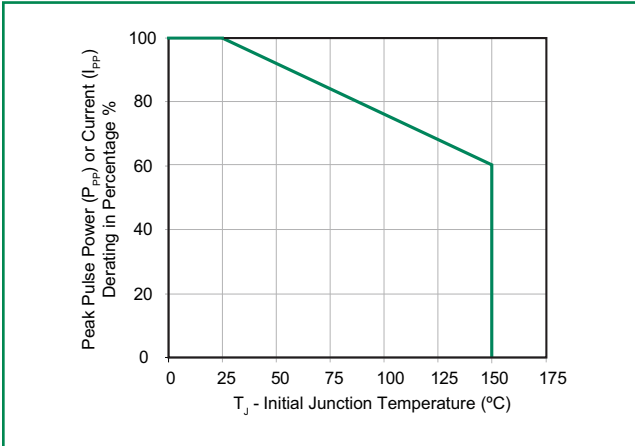
**Figure 2 - Peak Pulse Power Rating**



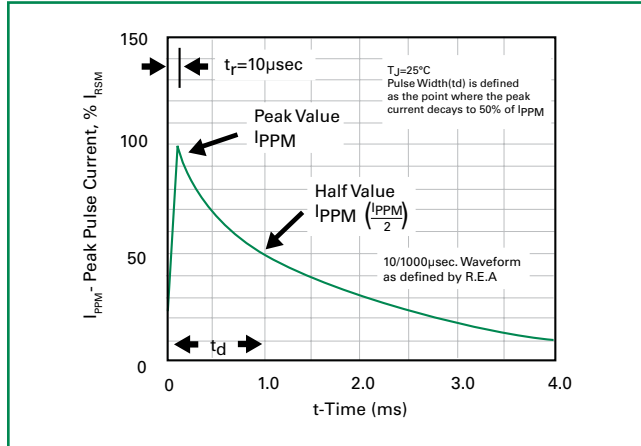
continues on next page.

**Ratings and Characteristic Curves** ( $T_A=25^\circ\text{C}$  unless otherwise noted) (Continued)

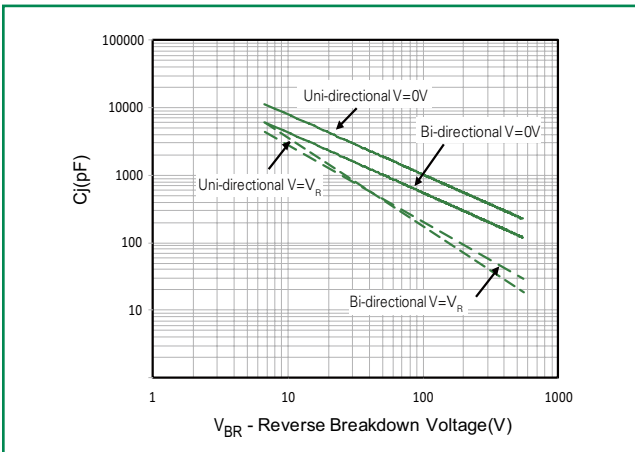
**Figure 3 - Peak Pulse Power Derating Curve**



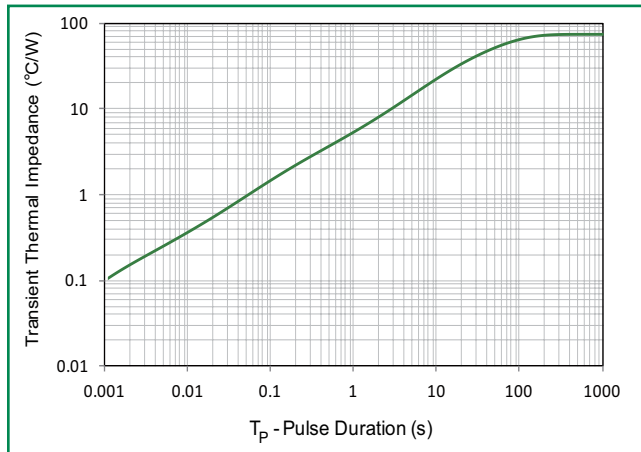
**Figure 4 - Pulse Waveform**



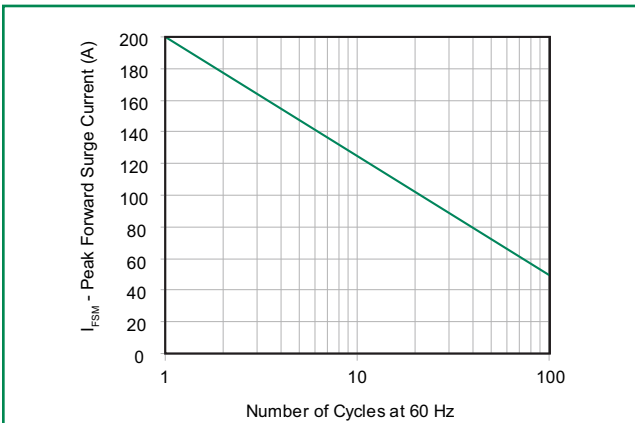
**Figure 5 - Typical Junction Capacitance**



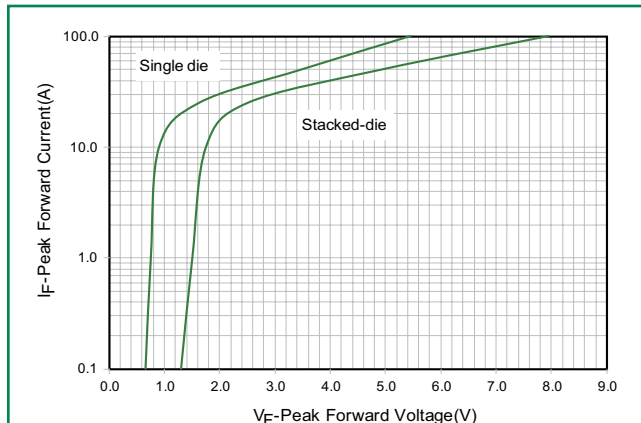
**Figure 6 - Typical Transient Thermal Impedance**



**Figure 7 - Maximum Non-Repetitive Peak Forward Surge Current Uni-Directional Only**

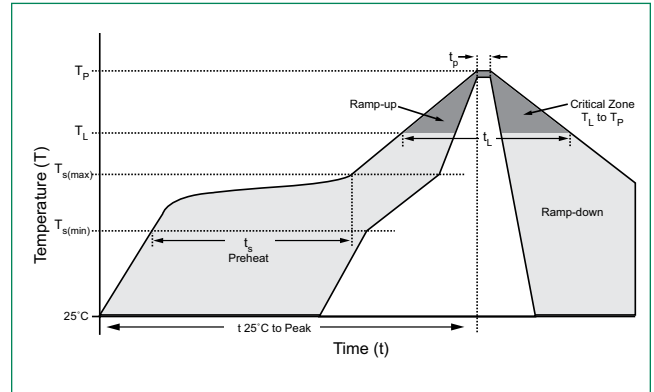


**Figure 8 - Peak Forward Voltage Drop vs Peak Forward Current (Typical Values)**



### Soldering Parameters

Reflow Condition		Lead-free assembly
Pre Heat	- Temperature Min ( $T_{s(min)}$ )	150°C
	- Temperature Max ( $T_{s(max)}$ )	200°C
	- Time (min to max) ( $t_s$ )	60 – 180 secs
Average ramp up rate (Liquidus Temp ( $T_A$ ) to peak)		3°C/second max
$T_{s(max)}$ to $T_A$ - Ramp-up Rate		3°C/second max
Reflow	- Temperature ( $T_A$ ) (Liquidus)	217°C
	- Time (min to max) ( $t_s$ )	60 – 150 seconds
Peak Temperature ( $T_p$ )		260 <sup>+0/-5</sup> °C
Time within 5°C of actual peak Temperature ( $t_p$ )		20 – 40 seconds
Ramp-down Rate		6°C/second max
Time 25°C to peak Temperature ( $T_p$ )		8 minutes Max.
Do not exceed		260°C



### Physical Specifications

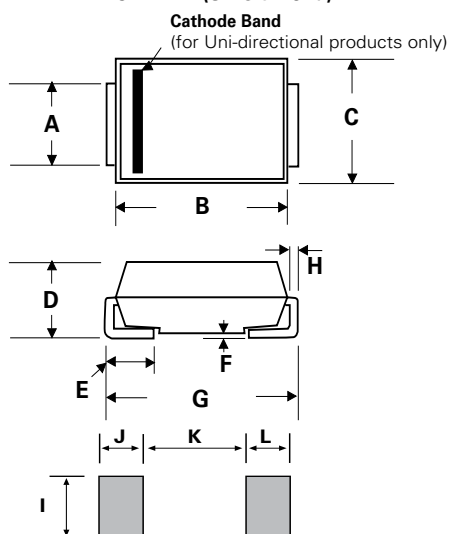
<b>Weight</b>	0.007 ounce, 0.21 grams
<b>Case</b>	JEDEC DO214AB. Molded plastic body over glass passivated junction
<b>Polarity</b>	Color band denotes positive end (cathode) except Bidirectional.
<b>Terminal</b>	Matte Tin-plated leads, Solderable per JESD22-B102

### Environmental Specifications

<b>High Temp. Storage</b>	JESD22-A103
<b>HTRB</b>	JESD22-A108
<b>Temperature Cycling</b>	JESD22-A104
<b>MSL</b>	JEDEC-J-STD-020, Level 1
<b>H3TRB</b>	JESD22-A101
<b>RSH</b>	JESD22-A111

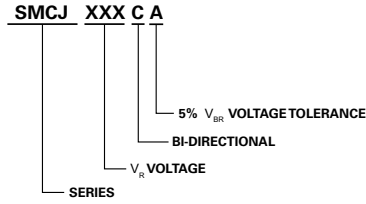
### Dimensions

#### DO-214AB (SMC J-Bend)

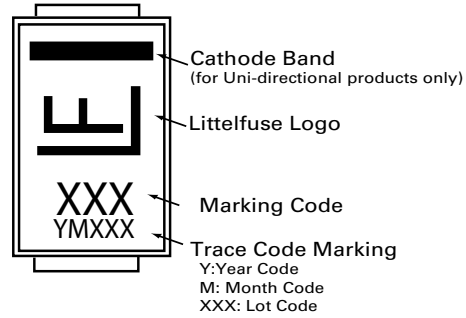


Dimensions	Inches		Millimeters	
	Min	Max	Min	Max
A	0.114	0.126	2.900	3.200
B	0.260	0.280	6.600	7.110
C	0.220	0.245	5.590	6.220
D	0.079	0.103	2.060	2.620
E	0.030	0.060	0.760	1.520
F	-	0.008	-	0.203
G	0.305	0.320	7.750	8.130
H	0.006	0.012	0.152	0.305
I	0.129	-	3.300	-
J	0.094	-	2.400	-
K	-	0.165	-	4.200
L	0.094	-	2.400	-

### Part Numbering System



### Part Marking System



### Packaging

Part number	Component Package	Quantity	Packaging Option	Packaging Specification
SMCJxxxXX	DO-214AB	3000	Tape & Reel - 16mm tape/13" reel	EIA STD RS-481

### Tape and Reel Specification

