

Current Transducer CASR series

$I_{PN} = 6, 15, 25, 50 \text{ A}$

Ref: CASR 6-NP, CASR 15-NP, CASR 25-NP, CASR 50-NP

For the electronic measurement of current: DC, AC, pulsed..., with galvanic isolation between the primary and the secondary circuit.

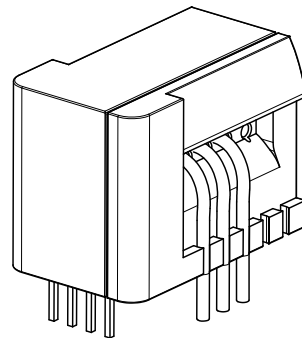

Features

- Closed loop (compensated) multi-range current transducer
- Voltage output
- Single supply
- Isolated plastic case material recognized according to UL 94-V0
- Compact design for PCB mounting.

Advantages

- Very low temperature coefficient of offset
- Very good dv/dt immunity
- LTSR compatible footprint
- Reduced height
- Reference pin with two modes: Ref IN and Ref OUT
- Extended measuring range for unipolar measurement.

Applications

- AC variable speed and servo motor drives
- Static converters for DC motor drives
- Battery supplied applications
- Uninterruptible Power Supplies (UPS)
- Switched Mode Power Supplies (SMPS)
- Power supplies for welding applications
- Solar inverters.

Standards

- EN 50178
- UL 508
- IEC 61010-1 (safety).

Application Domain

- Industrial.

Absolute maximum ratings

Parameter	Symbol	Unit	Value
Supply voltage	V_C	V	7
Primary conductor temperature		°C	110
Maximum primary current	$I_{P\ max}$	A	$20 \times I_{PN}$
ESD rating, Human Body Model (HBM)		kV	4

Stresses above these ratings may cause permanent damage. Exposure to absolute maximum ratings for extended periods may degrade reliability.

Isolation characteristics

Parameter	Symbol	Unit	Value	Comment
RMS voltage for AC isolation test 50/60Hz/1 min	V_d	kV	4.1	
Impulse withstand voltage 1.2/50 μ s	\hat{V}_w	kV	7.5	
Partial discharge extinction voltage @ 10 pC (rms)	V_e	V	1000	
Clearance distance (pri. - sec.)	dCl	mm	7.5	Shortest distance through air
Creepage distance (pri. - sec.)	dCp	mm	7.5	Shortest path along device body
Creepage distance (pri. .- sec.)	dCp	mm	6.2	When mounted on PCB with recommended layout
Case material	-	-	V0 according to UL 94	
Comparative tracking index	CTI	V	600	
Application example	-	-	300 V CAT III PD2	Reinforced isolation, non uniform field according to EN 50178, EN 61010
Application example	-	-	600 V CAT III PD2	Simple isolation, non uniform field according to EN 50178, EN 61010
According to UL 508: primary potential involved in Volts RMS AC or DC	-	V	600	For use in a pollution degree 2 environment

Environmental and mechanical characteristics

Parameter	Symbol	Unit	Min	Typ	Max	Comment
Ambient operating temperature	T_A	°C	-40		85	
Ambient storage temperature	T_S	°C	-55		105	
Mass	m	g		9		
Standards	EN 50178, IEC 60950-1, IEC 61010-1, IEC 61326-1, UL 508					

Electrical data CASR 6-NP

 At $T_A = 25^\circ\text{C}$, $V_C = +5\text{ V}$, $N_P = 1$ turn, $R_L = 10\text{ k}\Omega$, internal reference, unless otherwise noted.

Parameter	Symbol	Unit	Min	Typ	Max	Comment
Primary nominal current rms	I_{PN}	A		6		
Primary current, measuring range	I_{PM}	A	-20		20	
Number of primary turns	N_P	-		1,2,3		
Supply voltage	V_C	V	4.75	5	5.25	
Current consumption	I_C	mA		$15 + \frac{I_P \text{ (mA)}}{N_S}$	$20 + \frac{I_P \text{ (mA)}}{N_S}$	$N_S = 1731$ turns
Reference voltage @ $I_P = 0\text{ A}$	V_{REF}	V	2.495	2.5	2.505	Internal reference
External reference voltage	V_{REF}	V	0		4	
Output voltage	V_{OUT}	V	0.375		4.625	
Output voltage @ $I_P = 0\text{ A}$	V_{OUT}	V		V_{REF}		
Electrical offset voltage	V_{OE}	mV	-5.3		5.3	100% tested $V_{OUT} - V_{REF}$
Electrical offset current referred to primary	I_{OE}	mA	-51		51	100% tested
Temperature coefficient of V_{REF}	TCV_{REF}	ppm/K		± 5	± 50	Internal reference
Temperature coefficient of V_{OUT} @ $I_P = 0\text{ A}$	TCV_{OUT}	ppm/K		± 6	± 14	ppm/K of 2.5 V - 40°C .. 85°C
Theoretical sensitivity	G_{th}	mV/A		104.2		625 mV / I_{PN}
Sensitivity error	ϵ_G	%	-0.7		0.7	100% tested
Temperature coefficient of G	TCG	ppm/K			± 40	- 40°C .. 85°C
Linearity error	ϵ_L	% of I_{PN}	-0.1		0.1	
Magnetic offset current (10 x I_{PN}) referred to primary	I_{OM}	A	-0.1		0.1	
Output current noise (spectral density) rms 100 Hz .. 100 kHz referred to primary	i_{no}	$\mu\text{A}/\text{Hz}^{1/2}$		20		$R_L = 1\text{ k}\Omega$
Peak-peak output ripple at oscillator frequency $f = 450\text{ kHz}$ (typ.)	-	mV		40	160	$R_L = 1\text{ k}\Omega$
Reaction time @ 10 % of I_{PN}	t_{ra}	μs			0.3	$R_L = 1\text{ k}\Omega$ $di/dt = 18\text{ A}/\mu\text{s}$
Response time @ 90 % of I_{PN}	t_r	μs			0.3	$R_L = 1\text{ k}\Omega$ $di/dt = 18\text{ A}/\mu\text{s}$
Frequency bandwidth ($\pm 1\text{ dB}$)	BW	kHz	200			$R_L = 1\text{ k}\Omega$
Frequency bandwidth ($\pm 3\text{ dB}$)	BW	kHz	300			$R_L = 1\text{ k}\Omega$
Overall accuracy	X_G	% of I_{PN}			1.7	
Overall accuracy @ $T_A = 85^\circ\text{C}$	X_G	% of I_{PN}			2.2	
Accuracy	X	% of I_{PN}			0.8	
Accuracy @ $T_A = 85^\circ\text{C}$	X	% of I_{PN}			1.4	

Electrical data CASR 15-NP

 At $T_A = 25^\circ\text{C}$, $V_C = +5\text{ V}$, $N_P = 1$ turn, $R_L = 10\text{ k}\Omega$, internal reference, unless otherwise noted.

Parameter	Symbol	Unit	Min	Typ	Max	Comment
Primary nominal current rms	I_{PN}	A		15		
Primary current, measuring range	I_{PM}	A	-51		51	
Number of primary turns	N_P	-		1,2,3		
Supply voltage	V_C	V	4.75	5	5.25	
Current consumption	I_C	mA		$15 + \frac{I_P \text{ (mA)}}{N_S}$	$20 + \frac{I_P \text{ (mA)}}{N_S}$	$N_S = 1731$ turns
Reference voltage @ $I_P = 0\text{ A}$	V_{REF}	V	2.495	2.5	2.505	Internal reference
External reference voltage	V_{REF}	V	0		4	
Output voltage	V_{OUT}	V	0.375		4.625	
Output voltage @ $I_P = 0\text{ A}$	V_{OUT}	V		V_{REF}		
Electrical offset voltage	V_{OE}	mV	-2.21		2.21	100% tested $V_{OUT} - V_{REF}$
Electrical offset current referred to primary	I_{OE}	mA	-53		53	100% tested
Temperature coefficient of V_{REF}	TCV_{REF}	ppm/K		± 5	± 50	Internal reference
Temperature coefficient of V_{OUT} @ $I_P = 0\text{ A}$	TCV_{OUT}	ppm/K		± 2.3	± 6	ppm/K of 2.5 V - $40^\circ\text{C} \dots 85^\circ\text{C}$
Theoretical sensitivity	G_{th}	mV/A		41.67		$625\text{ mV} / I_{PN}$
Sensitivity error	ϵ_G	%	-0.7		0.7	100% tested
Temperature coefficient of G	TCG	ppm/K			± 40	- $40^\circ\text{C} \dots 85^\circ\text{C}$
Linearity error	ϵ_L	% of I_{PN}	-0.1		0.1	
Magnetic offset current ($10 \times I_{PN}$) referred to primary	I_{OM}	A	-0.1		0.1	
Output current noise (spectral density) rms 100 Hz .. 100 kHz referred to primary	i_{no}	$\mu\text{A}/\text{Hz}^{1/2}$		20		$R_L = 1\text{ k}\Omega$
Peak-peak output ripple at oscillator frequency $f = 450\text{ kHz}$ (typ.)	-	mV		15	60	$R_L = 1\text{ k}\Omega$
Reaction time @ 10 % of I_{PN}	t_{ra}	μs			0.3	$R_L = 1\text{ k}\Omega$ $di/dt = 44\text{ A}/\mu\text{s}$
Response time @ 90 % of I_{PN}	t_r	μs			0.3	$R_L = 1\text{ k}\Omega$ $di/dt = 44\text{ A}/\mu\text{s}$
Frequency bandwidth ($\pm 1\text{ dB}$)	BW	kHz	200			$R_L = 1\text{ k}\Omega$
Frequency bandwidth ($\pm 3\text{ dB}$)	BW	kHz	300			$R_L = 1\text{ k}\Omega$
Overall accuracy	X_G	% of I_{PN}			1.2	
Overall accuracy @ $T_A = 85^\circ\text{C}$	X_G	% of I_{PN}			1.5	
Accuracy	X	% of I_{PN}			0.8	
Accuracy @ $T_A = 85^\circ\text{C}$	X	% of I_{PN}			1.2	

Electrical data CASR 25-NP

 At $T_A = 25^\circ\text{C}$, $V_C = +5\text{ V}$, $N_P = 1$ turn, $R_L = 10\text{ k}\Omega$, internal reference, unless otherwise noted.

Parameter	Symbol	Unit	Min	Typ	Max	Comment
Primary nominal current rms	I_{PN}	A		25		
Primary current, measuring range	I_{PM}	A	-85		85	
Number of primary turns	N_P	-		1,2,3		
Supply voltage	V_C	V	4.75	5	5.25	
Current consumption	I_C	mA		$15 + \frac{I_P \text{ (mA)}}{N_S}$	$20 + \frac{I_P \text{ (mA)}}{N_S}$	$N_S = 1731$ turns
Reference voltage @ $I_P = 0\text{ A}$	V_{REF}	V	2.495	2.5	2.505	Internal reference
External reference voltage	V_{REF}	V	0		4	
Output voltage	V_{OUT}	V	0.375		4.625	
Output voltage @ $I_P = 0\text{ A}$	V_{OUT}	V		V_{REF}		
Electrical offset voltage	V_{OE}	mV	-1.35		1.35	100% tested $V_{OUT} - V_{REF}$
Electrical offset current referred to primary	I_{OE}	mA	-54		54	100% tested
Temperature coefficient of V_{REF}	TCV_{REF}	ppm/K		± 5	± 50	Internal reference
Temperature coefficient of V_{OUT} @ $I_P = 0\text{ A}$	TCV_{OUT}	ppm/K		± 1.4	± 4	ppm/K of 2.5 V - 40°C .. 85°C
Theoretical sensitivity	G_{th}	mV/A		25		625 mV/ I_{PN}
Sensitivity error	ϵ_G	%	-0.7		0.7	100% tested
Temperature coefficient of G	TCG	ppm/K			± 40	- 40°C .. 85°C
Linearity error	ϵ_L	% of I_{PN}	-0.1		0.1	
Magnetic offset current ($10 \times I_{PN}$) referred to primary	I_{OM}	A	-0.1		0.1	
Output current noise (spectral density) rms 100 Hz .. 100 kHz referred to primary	i_{no}	$\mu\text{A}/\text{Hz}^{1/2}$		20		$R_L = 1\text{ k}\Omega$
Peak-peak output ripple at oscillator frequency $f = 450\text{ kHz}$ (typ.)	-	mV		10	40	$R_L = 1\text{ k}\Omega$
Reaction time @ 10 % of I_{PN}	t_{ra}	μs			0.3	$R_L = 1\text{ k}\Omega$ $di/dt = 68\text{ A}/\mu\text{s}$
Response time @ 90 % of I_{PN}	t_r	μs			0.3	$R_L = 1\text{ k}\Omega$ $di/dt = 68\text{ A}/\mu\text{s}$
Frequency bandwidth ($\pm 1\text{ dB}$)	BW	kHz	200			$R_L = 1\text{ k}\Omega$
Frequency bandwidth ($\pm 3\text{ dB}$)	BW	kHz	300			$R_L = 1\text{ k}\Omega$
Overall accuracy	X_G	% of I_{PN}			1	
Overall accuracy @ $T_A = 85^\circ\text{C}$	X_G	% of I_{PN}			1.35	
Accuracy	X	% of I_{PN}			0.8	
Accuracy @ $T_A = 85^\circ\text{C}$	X	% of I_{PN}			1.15	

Electrical data CASR 50-NP

 At $T_A = 25^\circ\text{C}$, $V_C = +5\text{ V}$, $N_P = 1$ turn, $R_L = 10\text{ k}\Omega$, internal reference, unless otherwise noted.

Parameter	Symbol	Unit	Min	Typ	Max	Comment
Primary nominal current rms	I_{PN}	A		50		
Primary current, measuring range	I_{PM}	A	-150		150	
Number of primary turns	N_P	-		1,2,3		
Supply voltage	V_C	V	4.75	5	5.25	
Current consumption	I_C	mA		$15 + \frac{I_P \text{ (mA)}}{N_S}$	$20 + \frac{I_P \text{ (mA)}}{N_S}$	$N_S = 966$ turns
Reference voltage @ $I_p = 0\text{ A}$	V_{REF}	V	2.495	2.5	2.505	Internal reference
External reference voltage	V_{REF}	V	0		4	
Output voltage	V_{OUT}	V	0.375		4.625	
Output voltage @ $I_p = 0\text{ A}$	V_{OUT}	V		V_{REF}		
Electrical offset voltage	V_{OE}	mV	-0.725		0.725	100% tested $V_{OUT} - V_{REF}$
Electrical offset current referred to primary	I_{OE}	mA	-58		58	100% tested
Temperature coefficient of V_{REF}	TCV_{REF}	ppm/K		± 5	± 50	Internal reference
Temperature coefficient of V_{OUT} @ $I_p = 0\text{ A}$	TCV_{OUT}	ppm/K		± 0.7	± 3	ppm/K of 2.5 V - $40^\circ\text{C} \dots 85^\circ\text{C}$
Theoretical sensitivity	G_{th}	mV/A		12.5		$625\text{ mV} / I_{PN}$
Sensitivity error	ϵ_G	%	-0.7		0.7	100% tested
Temperature coefficient of G	TCG	ppm/K			± 40	- $40^\circ\text{C} \dots 85^\circ\text{C}$
Linearity error	ϵ_L	% of I_{PN}	-0.1		0.1	
Magnetic offset current ($10 \times I_{PN}$) referred to primary	I_{OM}	A	-0.1		0.1	
Output current noise (spectral density) rms 100 Hz .. 100 kHz referred to primary	i_{no}	$\mu\text{A}/\text{Hz}^{1/2}$		20		$R_L = 1\text{ k}\Omega$
Peak-peak output ripple at oscillator frequency $f = 450\text{ kHz}$ (Typ.)	-	mV		5	20	$R_L = 1\text{ k}\Omega$
Reaction time @ 10 % of I_{PN}	t_{ra}	μs			0.3	$R_L = 1\text{ k}\Omega$ $di/dt = 100\text{ A}/\mu\text{s}$
Response time @ 90 % of I_{PN}	t_r	μs			0.3	$R_L = 1\text{ k}\Omega$ $di/dt = 100\text{ A}/\mu\text{s}$
Frequency bandwidth ($\pm 1\text{ dB}$)	BW	kHz	200			$R_L = 1\text{ k}\Omega$
Frequency bandwidth ($\pm 3\text{ dB}$)	BW	kHz	300			$R_L = 1\text{ k}\Omega$
Overall accuracy	X_G	% of I_{PN}			0.9	
Overall accuracy @ $T_A = 85^\circ\text{C}$	X_G	% of I_{PN}			1.2	
Accuracy	X	% of I_{PN}			0.8	
Accuracy @ $T_A = 85^\circ\text{C}$	X	% of I_{PN}			1.1	

Typical performance characteristics CASR 6-NP

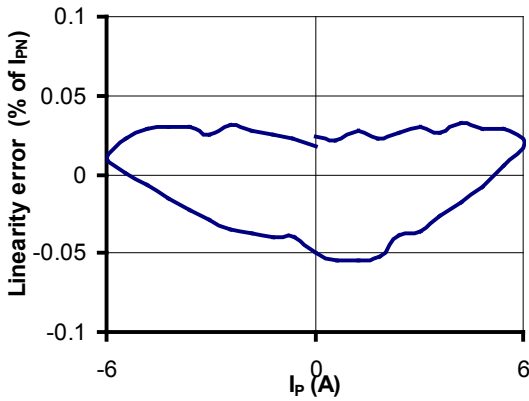

Figure 1: Linearity error

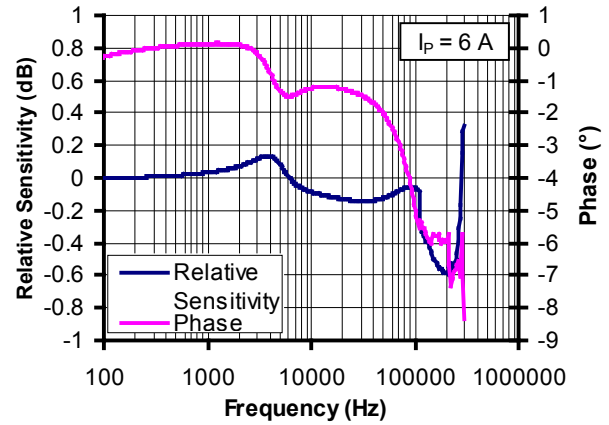

Figure 2: Frequency response

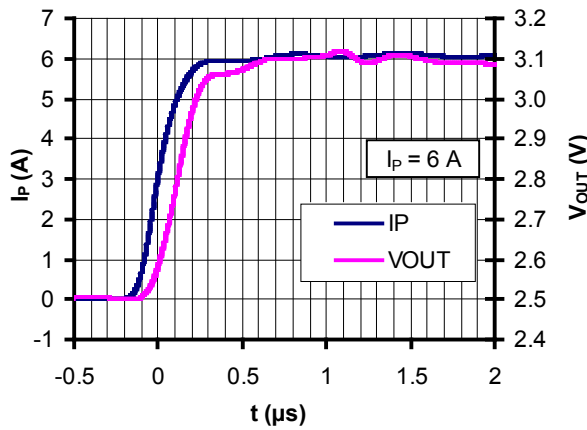

Figure 3: Step response

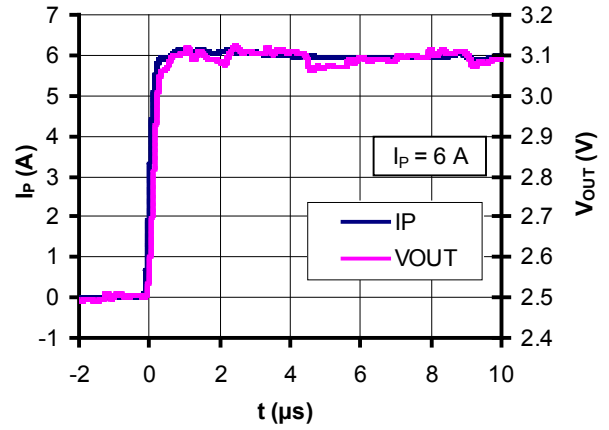

Figure 4: Step response

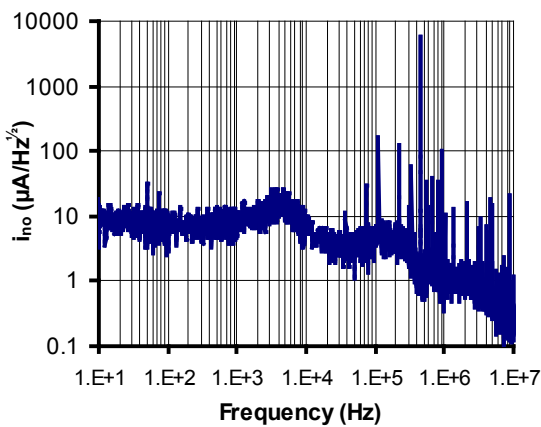

Figure 5: Input referred noise

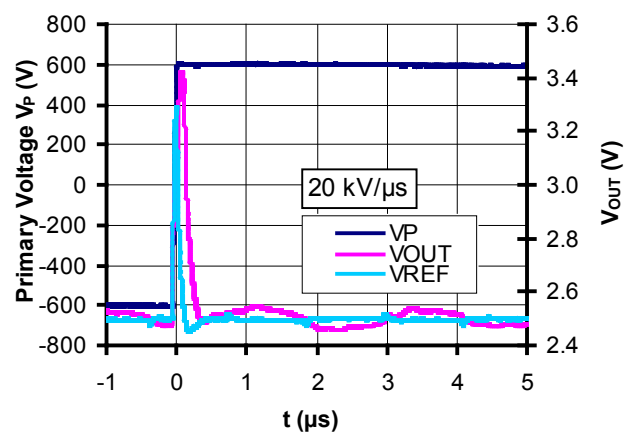

Figure 6: dv/dt

Typical performance characteristics CASR 15-NP

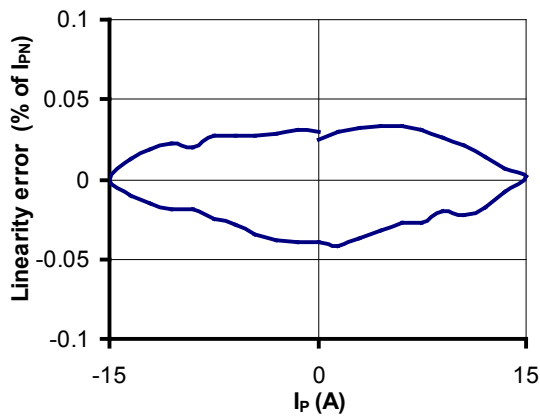

Figure 7: Linearity error

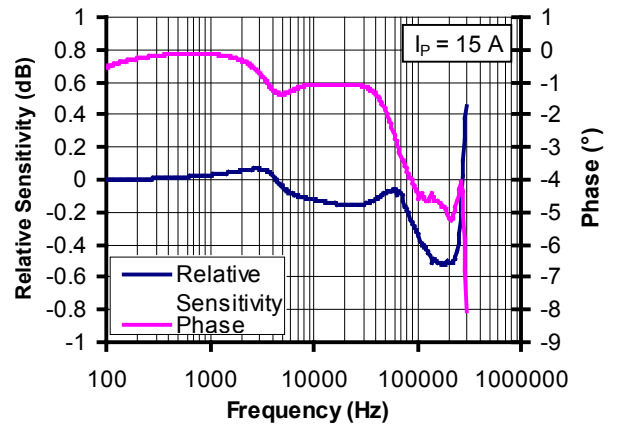

Figure 8: Frequency response

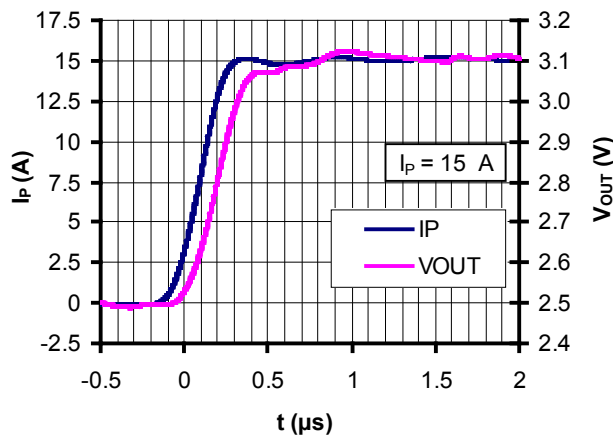

Figure 9: Step response

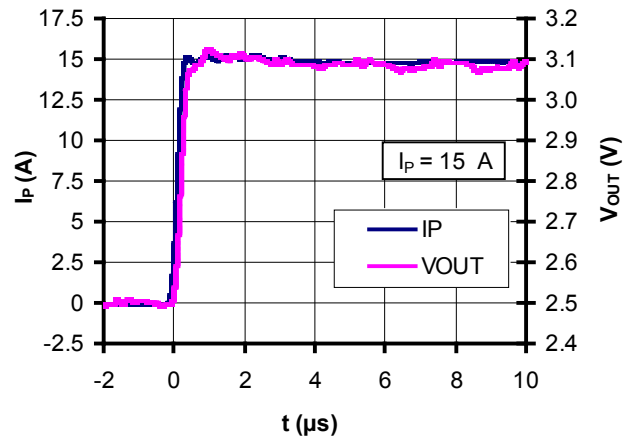

Figure 10: Step response

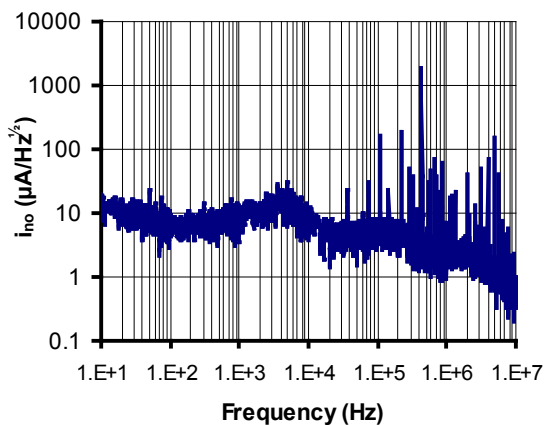

Figure 11: Input referred noise

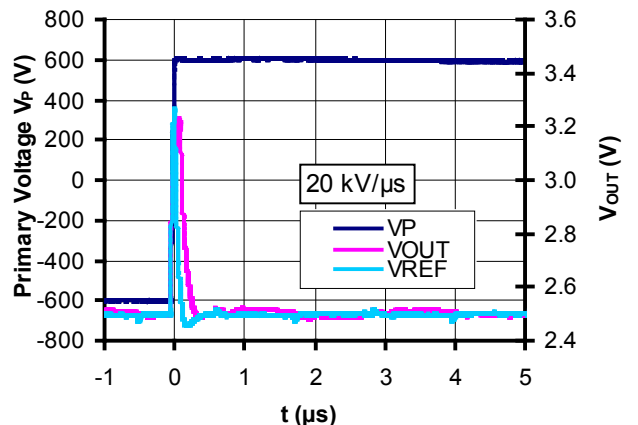

Figure 12: dv/dt

Typical performance characteristics CASR 25-NP

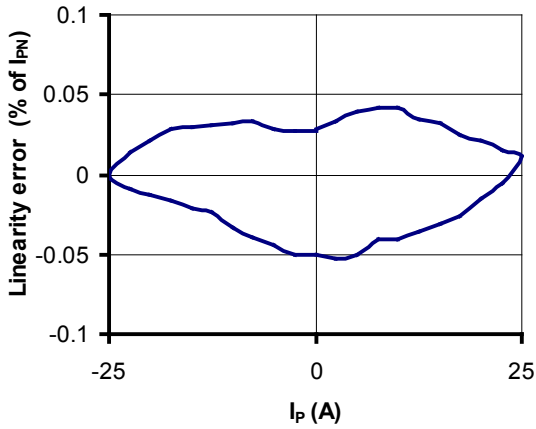

Figure 13: Linearity error

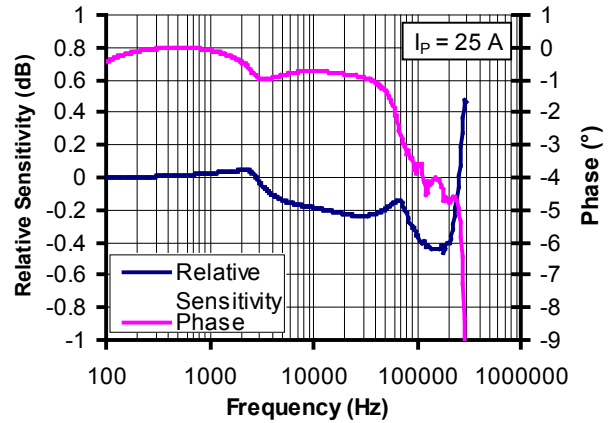

Figure 14: Frequency response

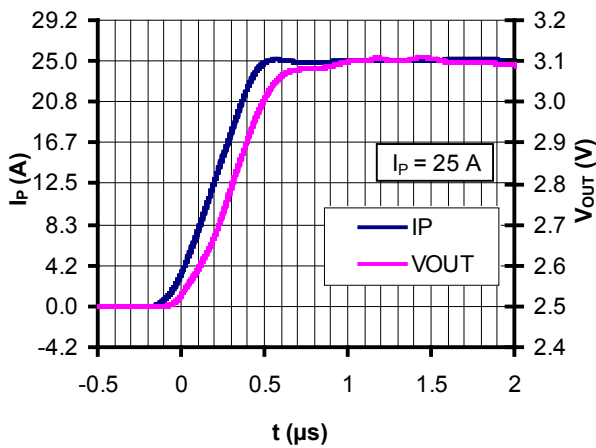

Figure 15: Step response

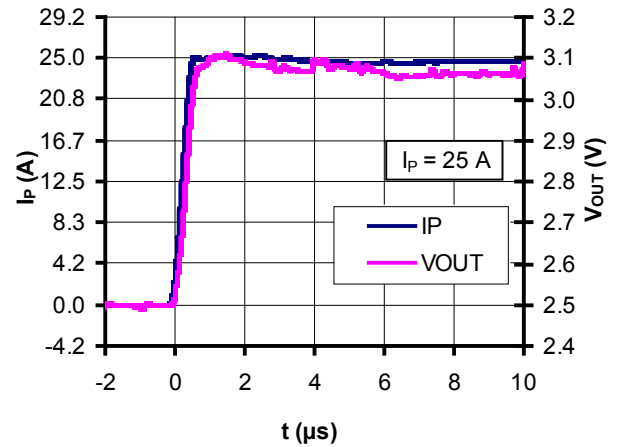

Figure 16: Step response

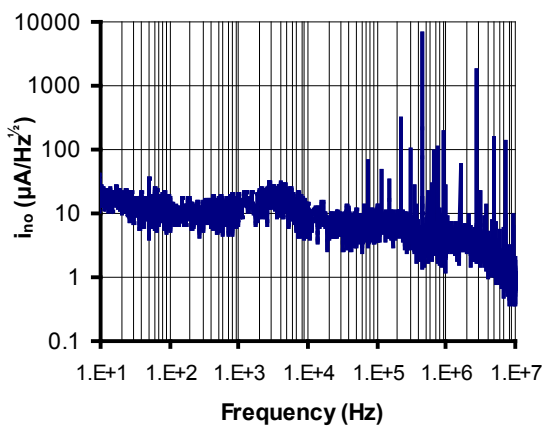

Figure 17: Input referred noise

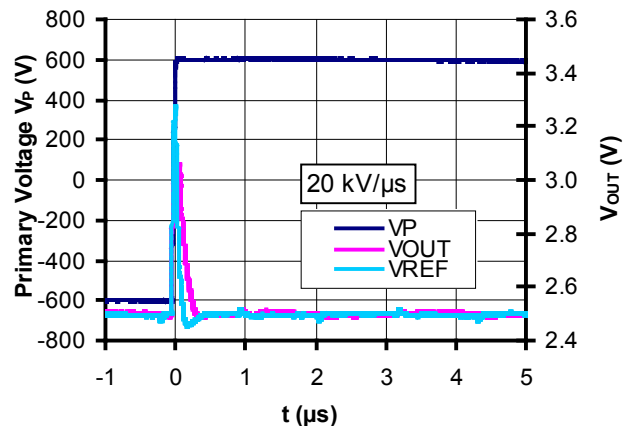

Figure 18: dv/dt

Typical performance characteristics CASR 50-NP

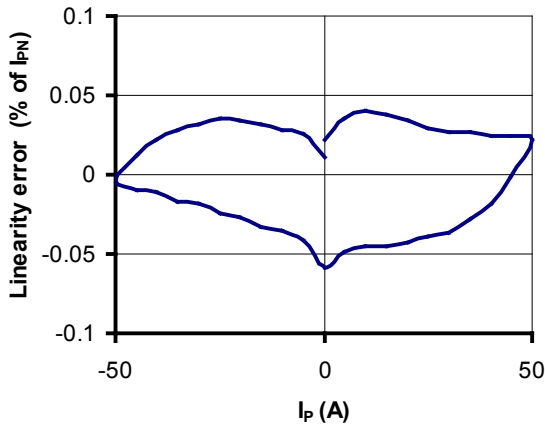

Figure 19: Linearity error

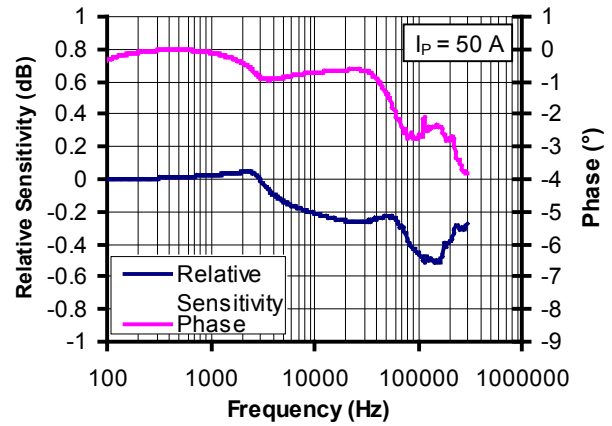

Figure 20: Frequency response

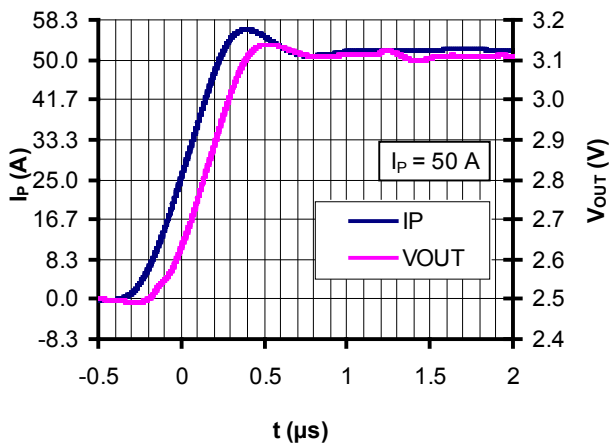

Figure 21: Step response

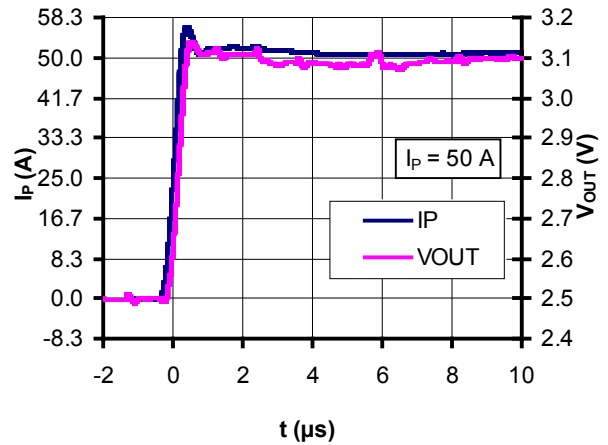

Figure 22: Step response

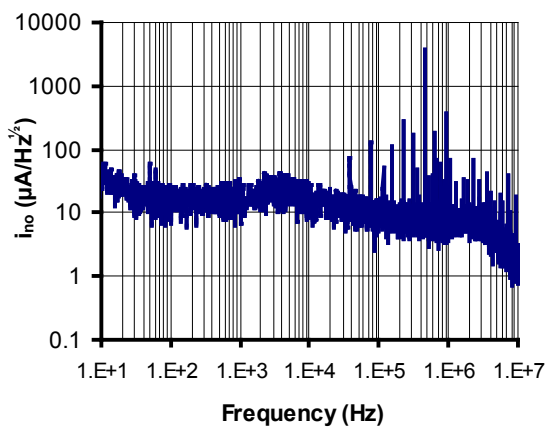

Figure 23: Input referred noise

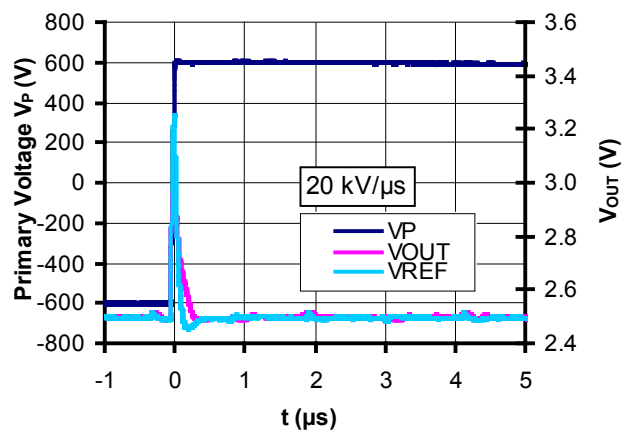

Figure 24: dv/dt

Maximum continuous DC primary current

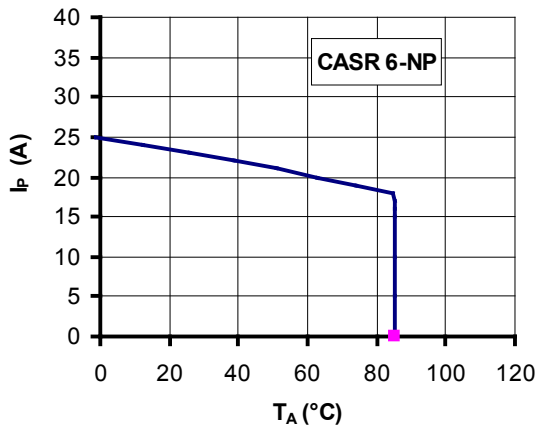

Figure 25: I_p vs T_A for CASR 6-NP

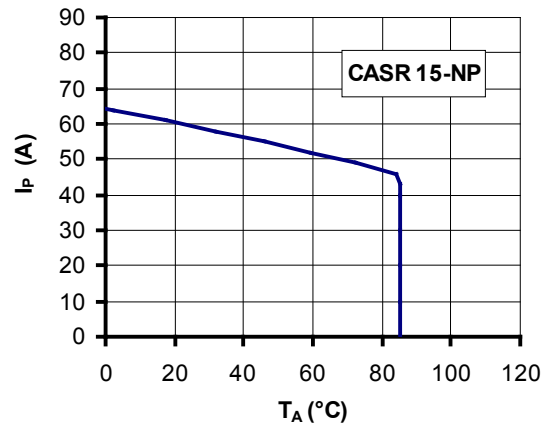

Figure 26: I_p vs T_A for CASR 15-NP

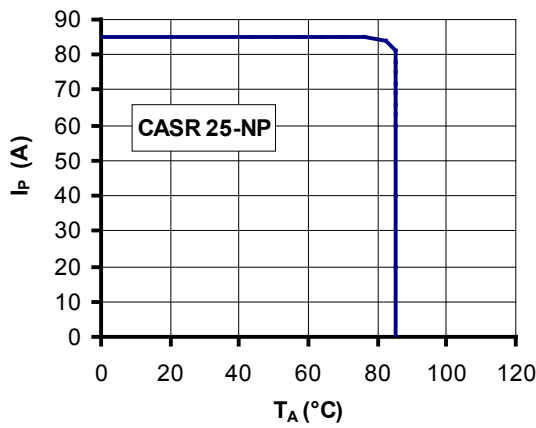

Figure 27: I_p vs T_A for CASR 25-NP

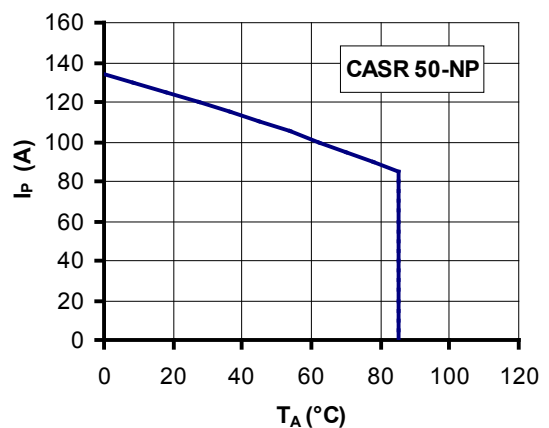

Figure 28: I_p vs T_A for CASR 50-NP

The maximum continuous DC primary current plot shows the boundary of the area for which all the following conditions are true:

- $I_p < I_{PM}$
- Junction temperature T_j < 125 °C
- Primary conductor temperature < 110 °C
- Resistor power dissipation < 0.5 x rated power

Frequency derating

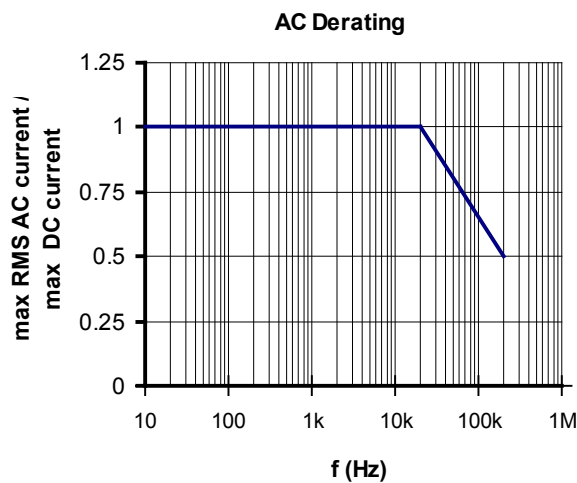

Figure 29: Maximum RMS AC primary current / maximum DC primary current vs frequency

Performance parameters definition

Ampere-turns and amperes

The transducer is sensitive to the primary current linkage Θ_p (also called ampere-turns).

$$\Theta_p = N_p I_p (At)$$

Where $N_p I_p$ the number of primary turn (1, 2 or 3 depending on the connection of the primary jumpers)

Caution: As most applications will use the transducer with only one single primary turn ($N_p = 1$), much of this datasheet is written in terms of primary current instead of current linkages. However, the ampere-turns (A-t) unit is used to emphasize that current linkages are intended and applicable.

Transducer simplified model

The static model of the transducer at temperature T_A is:

$$V_{OUT} = G \Theta_p + \text{error}$$

In which error =

$$V_{OE} + V_{OT}(T_A) + \varepsilon_G \cdot \Theta_p \cdot G + \varepsilon_L(\Theta_{Pmax}) \cdot \Theta_{Pmax} \cdot G + TCG \cdot (T_A - 25) \cdot \Theta_p \cdot G$$

- With:
- $\Theta_p = N_p I_p$:the input ampere-turns (At)
Please read above warning.
 - Θ_{pmax} :the maxi input ampere-turns that have been applied to the transducer (At)
 - V_{OUT} :the secondary voltage (V)
 - T_A :the ambient temperature ($^{\circ}C$)
 - V_{OE} :the electrical offset voltage (V)
 - $V_{OT}(T_A)$:the temperature variation of V_O at temperature T_A (V)
 - G** :the sensitivity of the transducer (V/At)
 - ε_G :the sensitivity error
 - $\varepsilon_L(\Theta_{Pmax})$:the linearity error for Θ_{Pmax}

This model is valid for primary ampere-turns Θ_p between $-\Theta_{Pmax}$ and $+\Theta_{Pmax}$ only.

Sensitivity and linearity

To measure sensitivity and linearity, the primary current (DC) is cycled from 0 to I_p , then to $-I_p$ and back to 0 (equally spaced $I_p/10$ steps).

The sensitivity G is defined as the slope of the linear regression line for a cycle between $\pm I_{PN}$.

The linearity error ε_L is the maximum positive or negative difference between the measured points and the linear regression line, expressed in % of I_{PN} .

Magnetic offset

The magnetic offset current I_{OM} is the consequence of a current on the primary side ("memory effect" of the transducer's ferro-magnetic parts). It is included in the linearity figure but can be measured individually.

It is measured using the following primary current cycle.

I_{OM} depends on the current value I_{p1} .

$$I_{OM} = \frac{V_{OUT}(t_1) - V_{OUT}(t_2)}{2} \cdot \frac{1}{Gth}$$

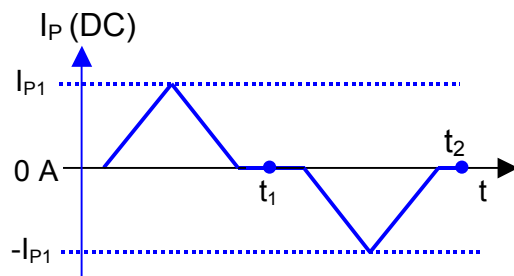

Figure 30: Current cycle used to measure magnetic and electrical offset (transducer supplied)

Performance parameters definition (continued)

Electrical offset

The electrical offset voltage V_{OE} can either be measured when the ferro-magnetic parts of the transducer are:

- completely demagnetized, which is difficult to realize,
- or in a known magnetization state, like in the current cycle shown in figure 30.

Using the current cycle shown in figure 30, the electrical offset is:

$$V_{OE} = \frac{V_{OUT}(t_1) + V_{OUT}(t_2)}{2}$$

The temperature variation V_{OT} of the electrical offset voltage V_{OE} is the variation of the electrical offset from 25°C to the considered temperature:

$$V_{OT}(T) = V_{OE}(T) - V_{OE}(25^\circ C)$$

Note: the transducer has to be demagnetized prior to the application of the current cycle (for example with a demagnetization tunnel).

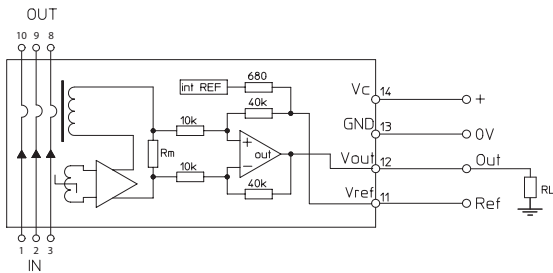

Figure 31: Test connection

Overall accuracy

The overall accuracy at 25°C X_G is the error in the $-I_{PN} \dots +I_{PN}$ range, relative to the rated value I_{PN} .

It includes:

- the electrical offset V_{OE}
- the sensitivity error ϵ_G
- the linearity error ϵ_L (to I_{PN})

The magnetic offset is part of the overall accuracy. It is taken into account in the linearity error figure provided the transducer has not been magnetized by a current higher than I_{PN} .

Response and reaction times

The response time t_r and the reaction time t_{ra} are shown in figure 31.

Both depend on the primary current di/dt . They are measured at nominal ampere-turns.

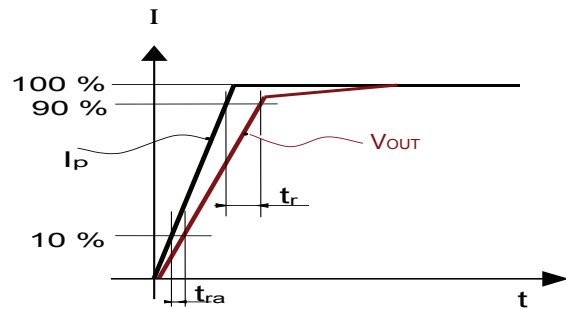

Figure 32: Response time t_r and reaction time t_{ra}

Application information

Filtering and decoupling

Supply voltage V_C



The fluxgate oscillator draws current pulses of up to 30 mA at a rate of ca. 900 kHz. Significant 900 kHz voltage ripple on V_C can indicate a power supply with high impedance. At these frequencies the power supply rejection ratio is low, and the ripple may appear on the transducer output V_{OUT} and reference V_{REF} . The transducer has internal decoupling capacitors, but in the case of a power supply with high impedance, it is advised to provide local decoupling (100 nF or more, located close to the transducer)

Output V_{OUT}

The output V_{OUT} has a very low output impedance of typically 2 Ohms; it can drive 100 pF directly. Adding series $R_f = 100$ Ohms allows much larger capacitive loads. Empirical evaluation may be necessary to obtain optimum results. The minimum load resistance on V_{OUT} is 1 kOhm.

Total Primary Resistance

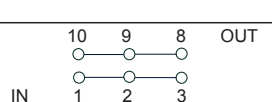
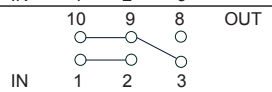
The primary resistance is 0.72 mΩ per conductor. In the following table, examples of primary resistance according to the number of primary turns.

Number of primary turns	Primary resistance R_p [mΩ]	Recommended connections
1	0.24	
2	1.08	
3	2.16	

Reference V_{REF}

Ripple present on the reference output can be filtered with a low value of capacitance because of the internal 680 Ohm series resistance. The maximum filter capacitance value is 1 μF. Application information

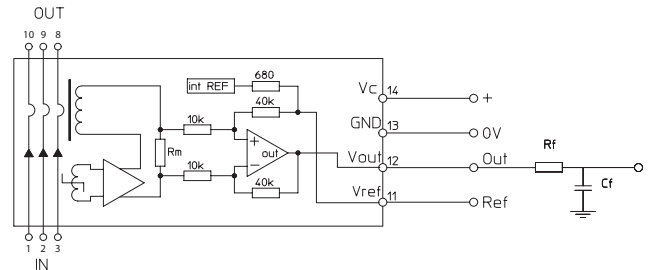

Application information (continued)

External reference voltage

If the Ref pin of the transducer is not used it could be either left unconnected or filtered according to the previous paragraph "Reference V_{REF} ".

The Ref pin has two modes Ref IN and Ref OUT:

- In the Ref OUT mode the 2.5 V internal precision reference is used by the transducer as the reference point for bipolar measurements; this internal reference is connected to the Ref pin of the transducer through a 680 Ohms resistor. it tolerates sink or source currents up to ± 5 mA, but the 680 Ohms resistor prevents this current to exceed these limits.
- In the Ref IN mode, an external reference voltage is connected to the Ref pin; this voltage is specified in the range 0 to 4 V and is directly used by the transducer as the reference point for measurements. The external reference voltage V_{ref} must be able:

- either to source a typical current of $\frac{V_{ref} - 2.5}{680}$, the maximum value will be 2.2 mA typ. when $V_{ref} = 4$ V.

- or to sink a typical current of $\frac{2.5 - V_{ref}}{680}$, the maximum value will be 3.68 mA typ. when $V_{ref} = 0$ V.

The following graphs show how the measuring range of each transducer version depends on the external reference voltage value V_{ref} .

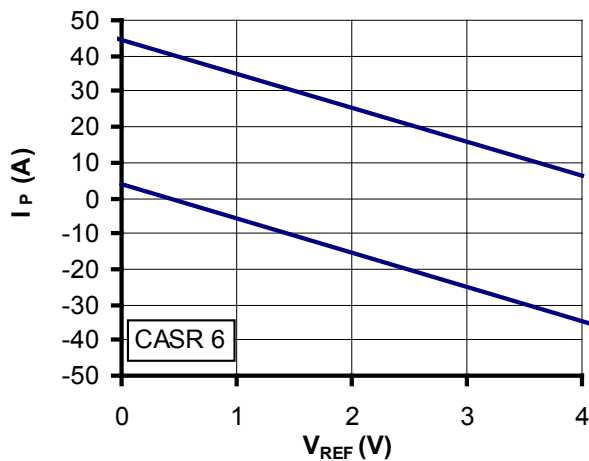

Upper limit : $I_p = -9.6 * V_{ref} + 44.4$ ($V_{ref} = 0 \dots 4$ V)

Lower limit : $I_p = -9.6 * V_{ref} + 3.6$ ($V_{ref} = 0 \dots 4$ V)

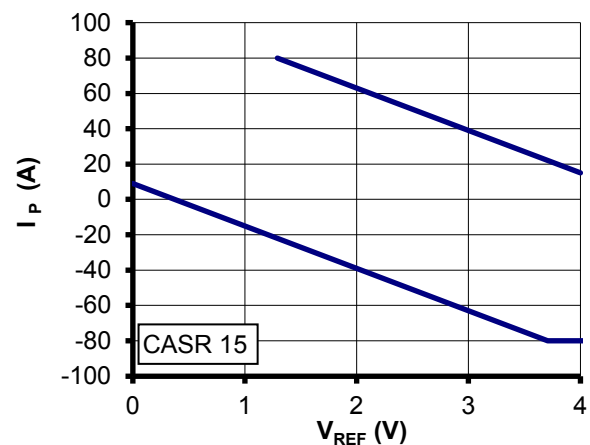

Upper limit : $I_p = -24 * V_{ref} + 111$ ($V_{ref} = 1.29 \dots 4$ V)

Upper limit : $I_p = 80$ ($V_{ref} = 0 \dots 1.29$ V)

Lower limit : $I_p = -24 * V_{ref} + 9$ ($V_{ref} = 0 \dots 3.7$ V)

Lower limit : $I_p = -80$ ($V_{ref} = 3.7 \dots 4$ V)

External reference voltage (continued)

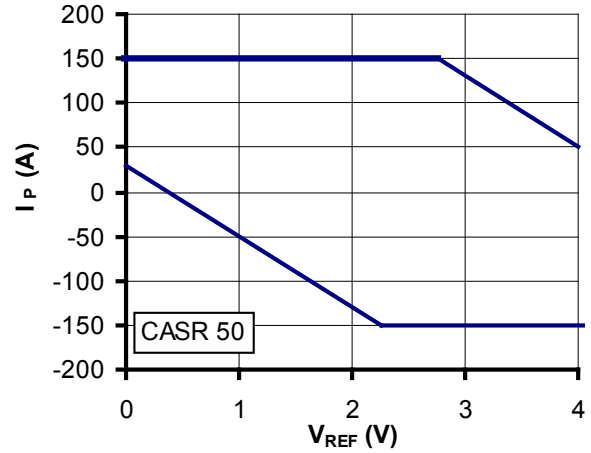
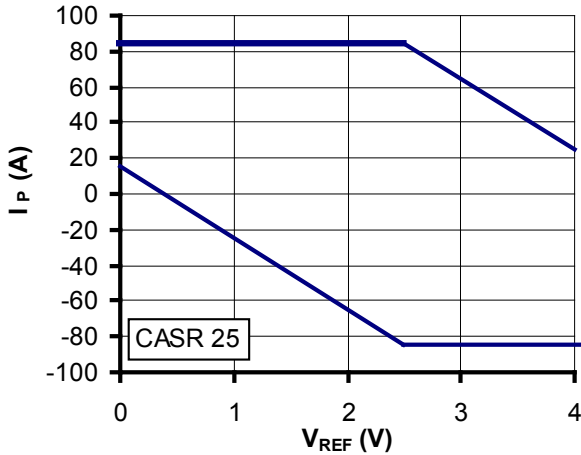

Upper limit : $I_p = -40 * V_{ref} + 185$ (Vref = 2.5 .. 4 V)
 Upper limit : $I_p = 85$ (Vref = 0 .. 2.5 V)
 Lower limit : $I_p = -40 * V_{ref} + 15$ (Vref = 0 .. 2.5 V)
 Lower limit : $I_p = -85$ (Vref = 2.5 .. 4 V)

Upper limit : $I_p = -80 * V_{ref} + 370$ (Vref = 2.75 .. 4 V)
 Upper limit : $I_p = 150$ (Vref = 0 .. 2.75 V)
 Lower limit : $I_p = -80 * V_{ref} + 30$ (Vref = 0 .. 2.25 V)
 Lower limit : $I_p = -150$ (Vref = 2.25 .. 4 V)

Example with $V_{REF} = 1.65$ V:

- The 6 A version has a measuring range from - 12.24 A to + 28.5 A
- The 15 A version has a measuring range from - 30.6 A to + 71.4 A
- The 25 A version has a measuring range from - 51 A to + 85 A
- The 50 A version has a measuring range from - 102 A to + 150 A

Example with $V_{REF} = 0$ V:

- The 6 A version has a measuring range from + 3.6 A to + 44.4 A
- The 15 A version has a measuring range from + 9 A to + 80 A
- The 25 A version has a measuring range from + 15 A to + 85 A
- The 50 A version has a measuring range from + 30 A to + 150 A

CASR Series, PCB footprint

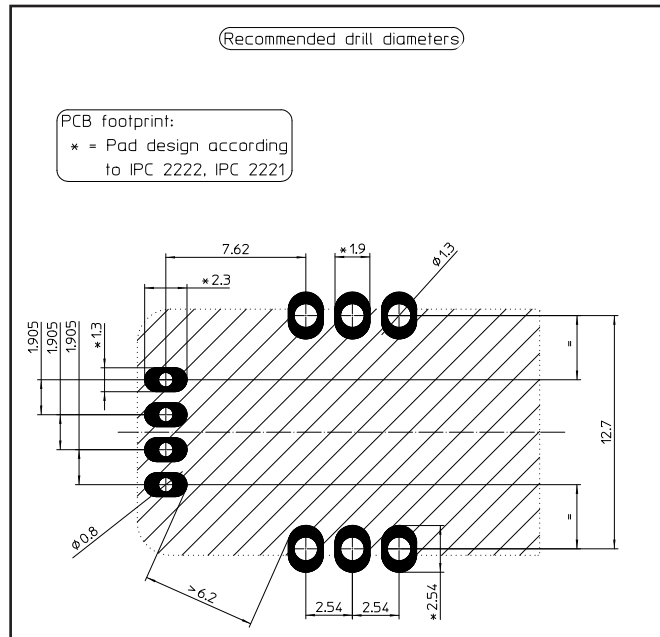

Assembly on PCB

- Recommended PCB hole diameter 1.3 mm for primary pin
0.8 mm for secondary pin
- Maximum PCB thickness 2.4 mm
- Wave soldering profile maximum 260°C for 10 s
No clean process only.

Safety

This transducer must be used in limited-energy secondary circuits according to IEC 61010-1.



This transducer must be used in electric/electronic equipment with respect to applicable standards and safety requirements in accordance with the manufacturer's operating instructions.



Caution, risk of electrical shock

When operating the transducer, certain parts of the module can carry hazardous voltage (eg. primary busbar, power supply). Ignoring this warning can lead to injury and/or cause serious damage. This transducer is a build-in device, whose conducting parts must be inaccessible after installation. A protective housing or additional shield could be used. Main supply must be able to be disconnected.

Dimensions CASR Series (in mm. General linear tolerance ± 0.25 mm)

