

### DESCRIPTION

The MP3429 is a 600kHz, fixed-frequency, wide input range, highly integrated, boost converter. The MP3429 starts from an input voltage as low as 2.7V and supports up to 30W of load power from a 1-cell battery with integrated low R<sub>DS(ON)</sub> power MOSFETs.

The MP3429 adopts constant-off-time (COT) control topology, which provides fast transient response. MODE supports the selection of pulse-skip mode (PSM), forced continuous conduction mode (FCCM), and ultrasonic mode (USM) in light-load condition. The cycle-by-cycle current limit on the low-side MOSFET prevents current runaway, and the high-side MOSFET eliminates the need for an external Schottky diode.

Full protection features include programmable input under-voltage lockout (UVLO) and over-temperature protection (OTP).

The MP3429 is available in a QFN-13 (3mmx4mm) package.

### FEATURES

- 2.7V to 13V Start-Up Voltage
- 0.8V to 13V Operating Voltage
- Up to 16V Output Voltage
- Supports 30W Average Power Load and 40W Peak Power Load from 3.3V
- 21.5A Internal Switch Current Limit
- Integrated 6.5mΩ and 10mΩ Power MOSFETs
- >95% Efficiency for 3.6V VIN to 9V/3A
- Selectable PSM, >23kHz USM, and FCCM in Light-Load Condition
- 600kHz Fixed Switching Frequency
- Adaptive COT for Fast Transient Response
- External Soft Start and Compensation Pins
- Programmable UVLO and Hysteresis
- 150°C Over-Temperature Protection (OTP)
- Available in a QFN-13 (3mmx4mm) Package

### APPLICATIONS

- Notebooks
- Bluetooth Speakers
- Portable POS Systems
- Quick-Charge Power Banks

All MPS parts are lead-free, halogen-free, and adhere to the RoHS directive. For MPS green status, please visit MPS website under Quality Assurance. "MPS" and "The Future of Analog IC Technology" are registered trademarks of Monolithic Power Systems, Inc.

### TYPICAL APPLICATION

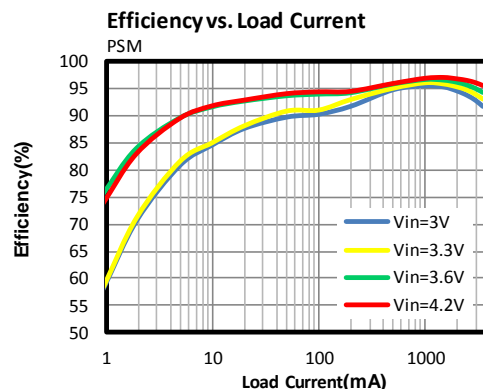
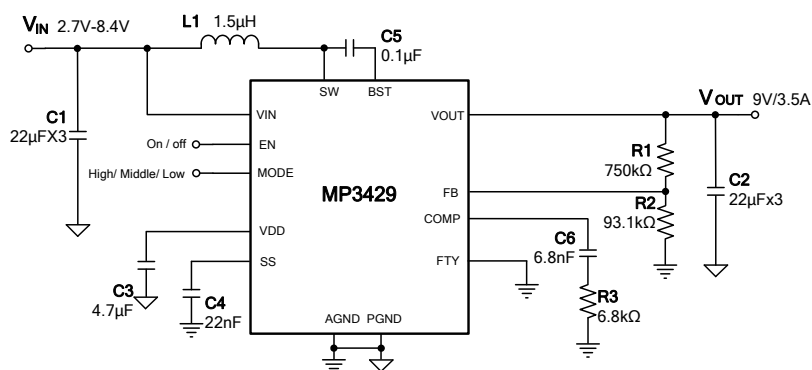

### ORDERING INFORMATION

Part Number*	Package	Top Marking
MP3429GL	QFN-13 (3mmx4mm)	See Below

\*For Tape & Reel, add suffix –Z (e.g. MP3429GL–Z)

### TOP MARKING

**MPYW**

**3429**

**LLL**

MP: MPS prefix  
Y: Year code  
W: Week code  
3429: First four digits of the part number  
LLL: Lot number

### PACKAGE REFERENCE

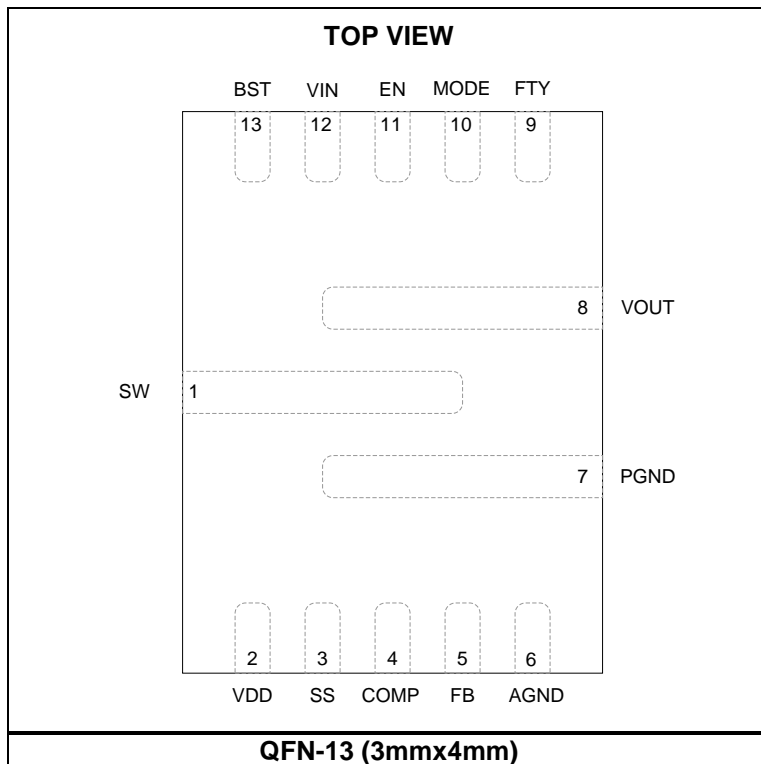

**ABSOLUTE MAXIMUM RATINGS** <sup>(1)</sup>

SW .....	-0.3V (-3.5V for <10ns) to +18V (22V for <10ns)
VIN, EN, MODE, VOUT .....	-0.3V to +18V
BST .....	-0.3V to V <sub>SW</sub> + 4.5V
All other pins.....	-0.3V to +4.5V
Continuous power dissipation (T <sub>A</sub> = +25°C) <sup>(2)</sup>	
.....	4W <sup>(5)</sup>
Junction temperature .....	150°C
Lead temperature .....	260°C
Storage temperature.....	-65°C to +150°C

**Recommended Operating Conditions** <sup>(3)</sup>

Start-up input voltage (V <sub>ST</sub> ) .....	2.7V to 13V
Operation input voltage (VIN).....	0.8V to 13V
Startup input voltage with VDD bias (V <sub>ST2</sub> ) .....	
.....	0.9V to 13V
Maximum external VDD bias voltage .....	3.6V <sup>(4)</sup>
Boost output voltage (VOUT) .....	VIN to 16V
Operating junction temp. (T <sub>J</sub> ) ..	-40°C to +125°C

<b>Thermal Resistance</b>	<b>θ<sub>JA</sub></b>	<b>θ<sub>JC</sub></b>
QFN-13 (3mmx4mm)		
EV3429-L-00A <sup>(5)</sup> .....	31 .....	4 .... °C/W
JESD51-7 <sup>(6)</sup> .....	48.....	11 ... °C/W

**NOTES:**

- 1) Exceeding these ratings may damage the device.
- 2) The maximum allowable power dissipation is a function of the maximum junction temperature T<sub>J</sub> (MAX), the junction-to-ambient thermal resistance θ<sub>JA</sub>, and the ambient temperature T<sub>A</sub>. The maximum allowable continuous power dissipation at any ambient temperature is calculated by P<sub>D</sub> (MAX) = (T<sub>J</sub> (MAX)-T<sub>A</sub>)/θ<sub>JA</sub>. Exceeding the maximum allowable power dissipation produces an excessive die temperature, causing the regulator to go into thermal shutdown. Internal thermal shutdown circuitry protects the device from permanent damage.
- 3) The device is not guaranteed to function outside of its operating conditions.
- 4) When the external VDD bias voltage is lower than the normal VDD regulated voltage, the external power prevents current from flowing out of VDD.
- 5) Measured on EV3429-L-00A, 4-layer 63mmx63mm PCB.
- 6) Measured on JESD51-7, 4-layer PCB.

## ELECTRICAL CHARACTERISTICS

$V_{IN} = V_{EN} = 3.3V$ ,  $T_J = -40^{\circ}C$  to  $125^{\circ}C$  <sup>(7)</sup>, typical values are tested at  $T_J = 25^{\circ}C$ , unless otherwise noted.

Parameter	Symbol	Condition	Min	Typ	Max	Units
<b>Power Supply</b>						
Start-up input voltage	$V_{ST}$	No VDD bias	2.7		13	V
		VDD = 3V	0.9		13	V
Operating input voltage	$V_{IN}$		0.8		13	V
Operating VDD voltage <sup>(8)</sup>	$V_{DD}$	$V_{IN} = 2.7V$ , 0 - 10mA	2.3	2.55		V
		$V_{IN} = 12V$ , 0 - 15mA		3.4		V
VDD UVLO rising <sup>(8)</sup>	$V_{DDUVLO-R}$	VDD rising	2.2	2.4	2.6	V
VDD UVLO falling	$V_{DDUVLO-F}$	VDD falling	2	2.2	2.4	V
Shutdown current	$I_{SD}$	$V_{EN} = 0V$ , measured on VIN			2	$\mu A$
Quiescent current	$I_Q$	$V_{FB} = 1.1V$ , $V_{IN} = 3V$ , VOUT = 9V, no switching, measured on VIN			25	$\mu A$
		$V_{FB} = 1.1V$ , $V_{IN} = 3V$ , VOUT = 9V, no switching, measured on VOUT		450	550	$\mu A$
<b>Enable (EN) Control</b>						
EN turn-on threshold voltage	$V_{EN-ON}$	$V_{EN}$ rising (switching)	1.15	1.23	1.31	V
EN high threshold voltage	$V_{EN-H}$	$V_{EN}$ rising (micro power)			1.0	V
EN low threshold voltage	$V_{EN-L}$	$V_{EN}$ falling (micro power)	0.4			V
EN turn-on hysteresis current	$I_{EN-HYS}$	$1.0V < EN < V_{EN-ON}$	3.5	5	6.5	$\mu A$
EN input current	$I_{EN}$	$V_{EN} = 0V$ , 1.5V		0		$\mu A$
EN turn-on delay		EN on to switching		180		$\mu s$
<b>Frequency</b>						
Switching frequency	$F_{SW}$	$V_{IN} = 3.3V$ , VOUT = 9V	500	600	700	kHz
LS-FET minimum on time <sup>(9)</sup>	$T_{MIN-ON}$			80		ns
LS-FET maximum on time	$T_{MAX-ON}$			7.5		$\mu s$
<b>Loop Control</b>						
FB reference voltage	$V_{REF}$	$T_J = 25^{\circ}C$	0.99	1	1.01	V
		$T_J = -40^{\circ}C$ to $125^{\circ}C$	0.985	1	1.015	V
FB input current	$I_{FB}$	$V_{FB} = 1.1V$			50	nA
Error amp voltage gain <sup>(10)</sup>	$A_{V-EA}$			300		V/V
Error amp transconductance	$G_{EA}$			450		$\mu A/V$
Error amp max. output current		$V_{FB} = 0.8V$ , $V_{COMP} = 1V$		63		$\mu A$
		$V_{FB} = 1.2V$ , $V_{COMP} = 1V$		-60		$\mu A$
COMP to current gain	$G_{CS}$			22		A/V
COMP PSM threshold <sup>(9)</sup>	$V_{PSM}$	$V_{MODE} = 0V$		0.5		V
COMP high clamp		$V_{FB} = 0.8V$		2.6		V
Soft-start charge current	$I_{SS}$		6	7.5	9	$\mu A$
<b>MODE Selection</b>						
PSM MODE tri-state region	$V_{MODE-TRI}$		0.2		0.7	V
USM MODE tri-state region <sup>(11)</sup>			0.9		1.2	
FCCM MODE tri-state region			1.6		VDD	
Ultrasonic mode frequency	$F_{USM}$		23	33		kHz
HS-FET ZCD		PSM, $V_{FB} = 1V$ , $L = 1.5\mu H$ , VOUT = 9V	-200	0	300	mA
HS-FET ZCD <sup>(9)</sup> <sup>(12)</sup>		$V_{FB} = 1.1V$ , USM and FCCM			-2	A

**ELECTRICAL CHARACTERISTICS (continued)**

VIN = VEN = 3.3V, TJ = -40°C to 125°C <sup>(7)</sup>, typical values are tested at TJ = 25°C, unless otherwise noted.

Parameter	Symbol	Condition	Min	Typ	Max	Units
<b>Power Switch</b>						
Low-side switch on resistance	R <sub>ON-L</sub>			6.5		mΩ
High-side synchronous switch on resistance	R <sub>ON-H</sub>			10		mΩ
Low-side switch leakage current		V <sub>SW</sub> = 16V, T <sub>J</sub> = 25°C			0.15	μA
High-side switch leakage current		V <sub>OUT</sub> = 16V, V <sub>SW</sub> = 0V, T <sub>J</sub> = 25°C			0.15	μA
<b>BST Power</b>						
BST voltage				3.3		V
<b>Current Limit</b>						
Switching current limit	I <sub>PK-LIMIT</sub>		19	21.5	23.5	A
<b>Protection</b>						
Output OVP threshold				16.5		V
Output OVP hysteresis				0.2		V
<b>Thermal Protection</b>						
Thermal shutdown <sup>(9)</sup>	T <sub>SD</sub>			150		°C
Thermal shutdown hysteresis <sup>(9)</sup>	T <sub>SD-HYS</sub>			25		°C

**NOTES:**

- 7) Guaranteed by over-temperature correlation, not tested in production.
- 8) VDD regulation voltage from 2.7V. VIN is higher than the VDD UVLO rising threshold in each unit, which can guarantee that the IC starts up with 2.7V VIN.
- 9) Guaranteed by sample characterization, not tested in production.
- 10) Guaranteed by design, not tested in production.
- 11) Add an external voltage within this range or float MODE for USM.
- 12) The HS-FET ZCD is lower than -2A in USM and FCCM.

## TYPICAL CHARACTERISTICS

VIN = VEN = 3.3V, VOUT = 9V, L = 1.5μH, TA = 25°C, unless otherwise noted.

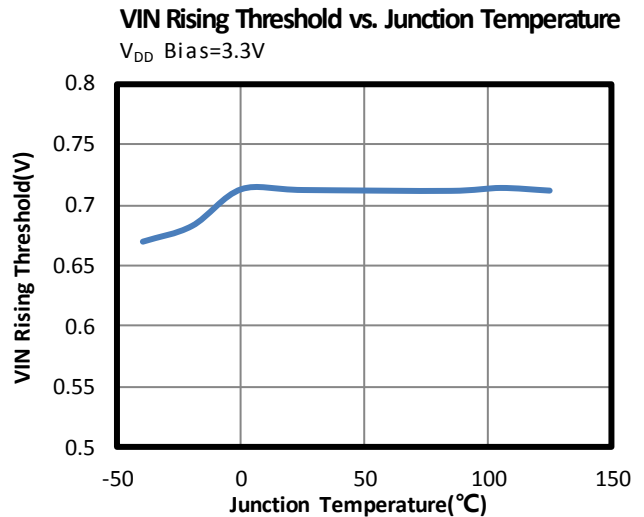
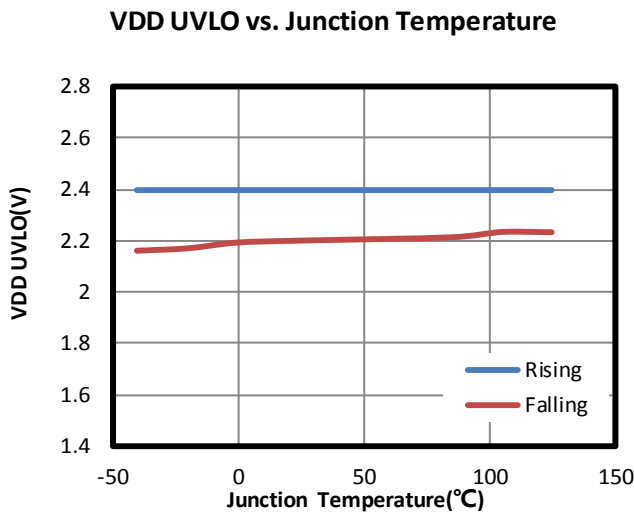
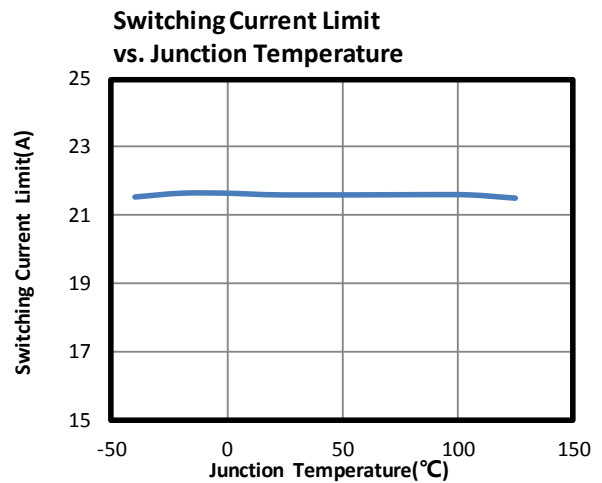
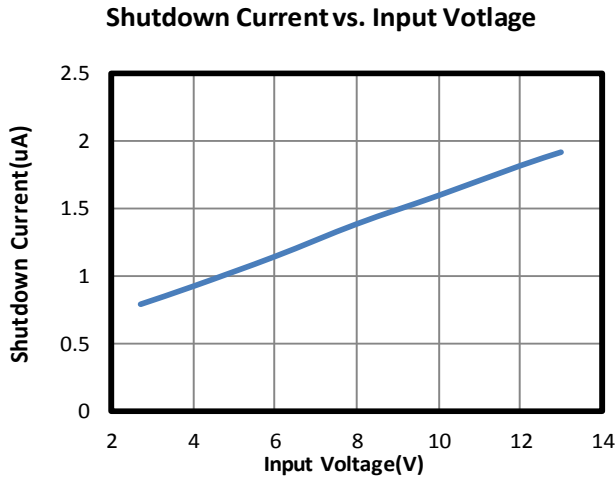
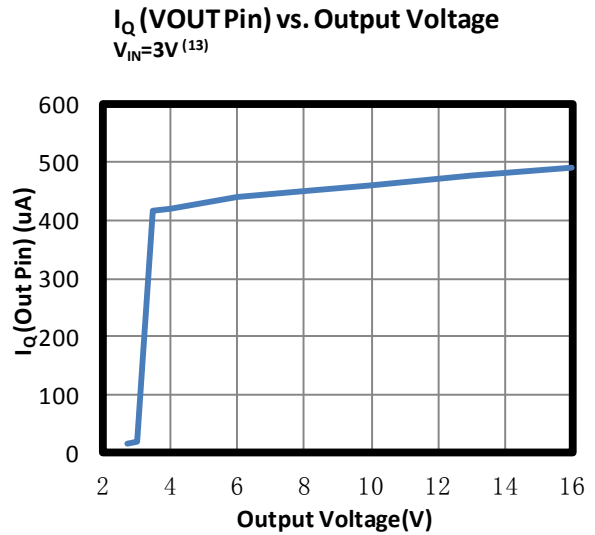
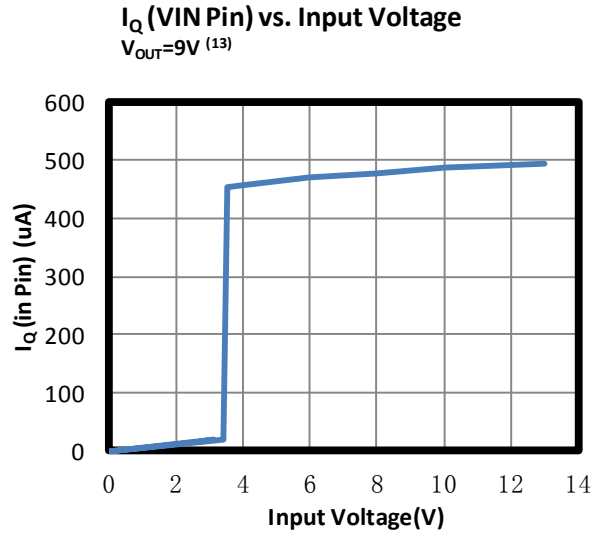

**NOTE:**

13) When VIN is higher than 3.4V, VIN supplies power to VDD, so the I<sub>Q</sub> on VIN rises higher when VIN > 3.4V. When VIN is 3V, the higher voltage source of either VIN or VOUT supplies VDD, so the I<sub>Q</sub> on VOUT rises higher when VOUT > 3V and VIN = 3V.

**TYPICAL CHARACTERISTICS (continued)**

VIN = VEN = 3.3V, VOUT = 9V, L = 1.5μH, TA = 25°C, unless otherwise noted.

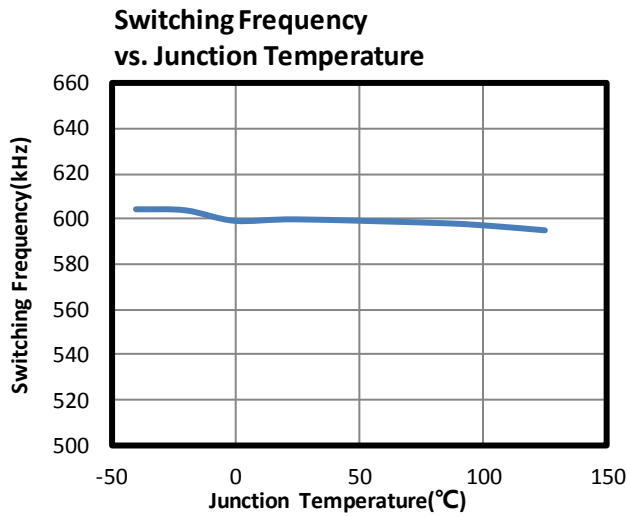
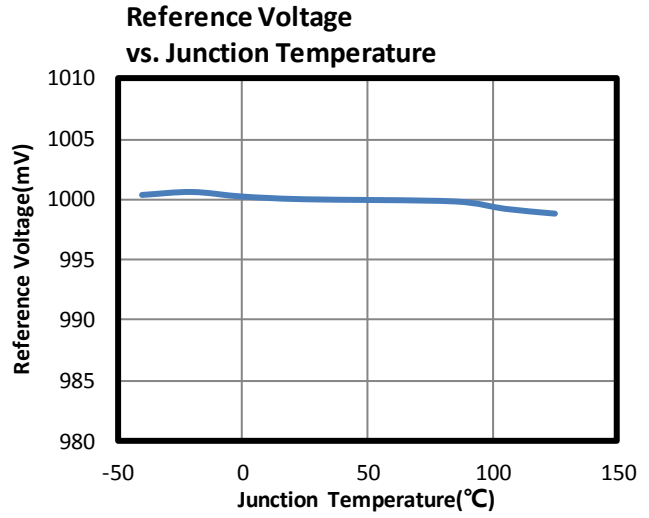
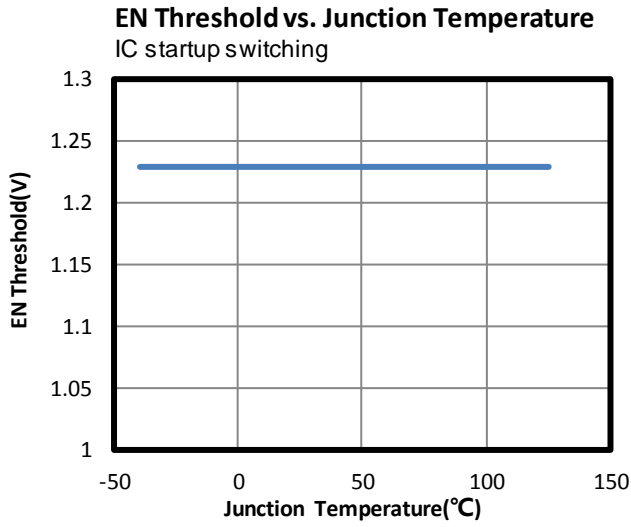

## TYPICAL PERFORMANCE CHARACTERISTICS

VIN = 3.3V, VOUT = 9V, L = 1.5μH, IOUT = 3.5A, USM, TA = 25°C, unless otherwise noted.

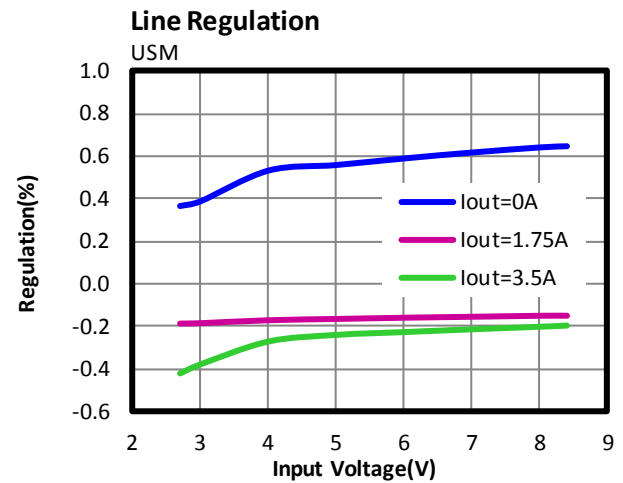
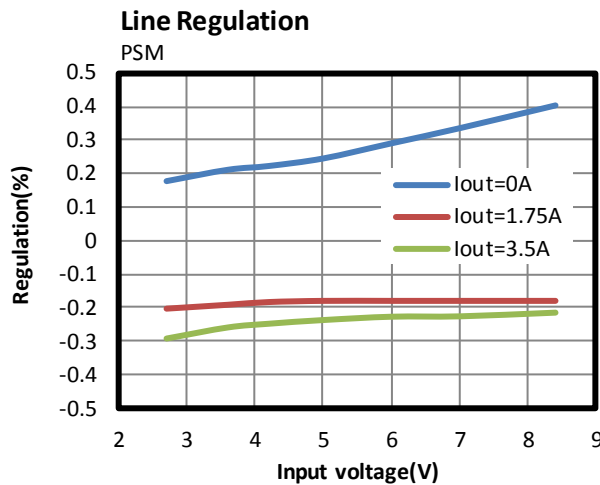
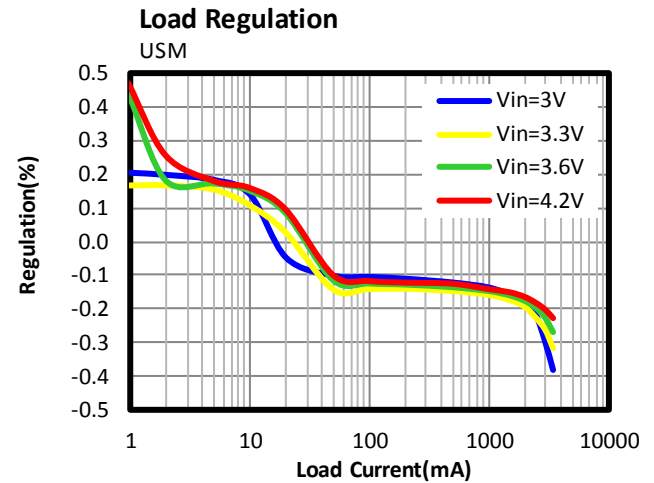
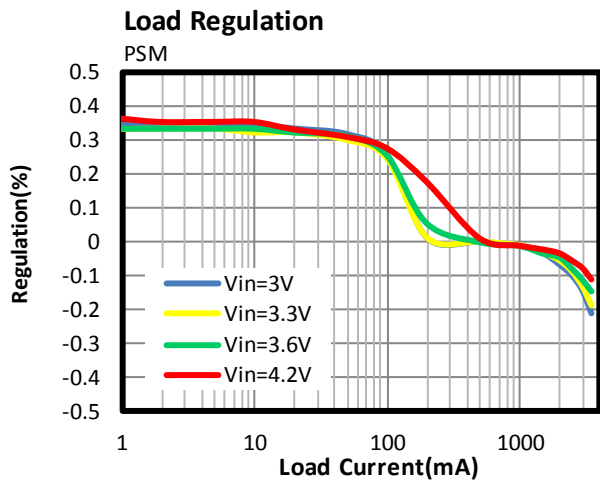
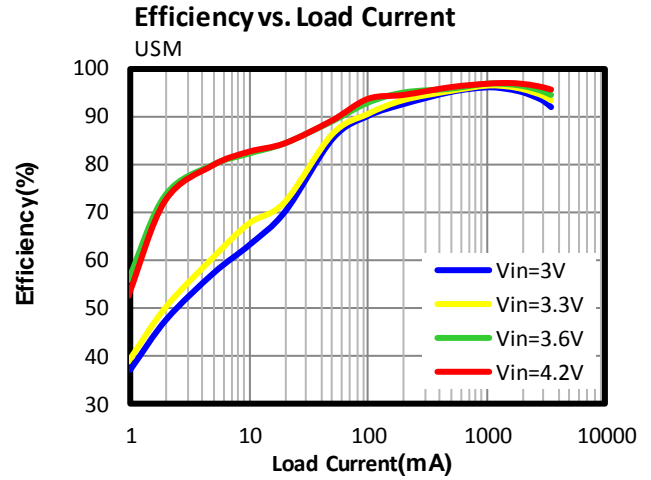
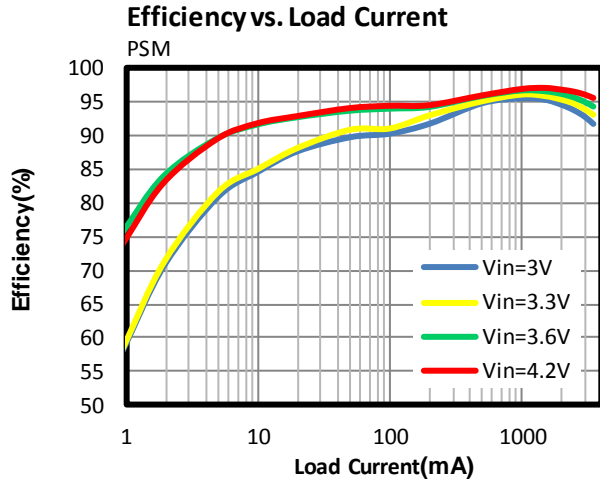



**TYPICAL PERFORMANCE CHARACTERISTICS (continued)**

VIN = 3.3V, VOUT = 9V, L = 1.5μH, IOUT = 3.5A, USM, TA = 25°C, unless otherwise noted.

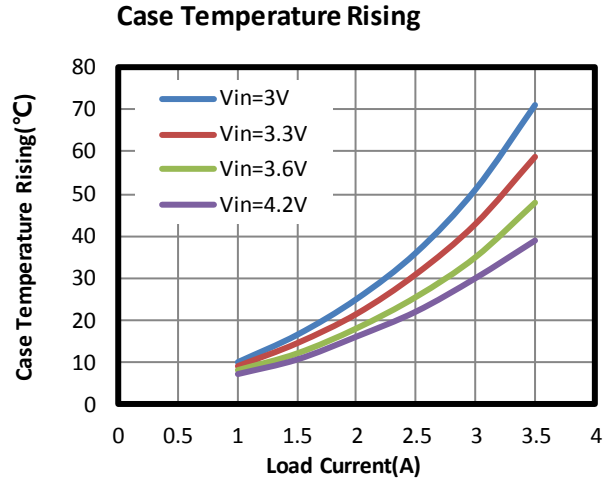
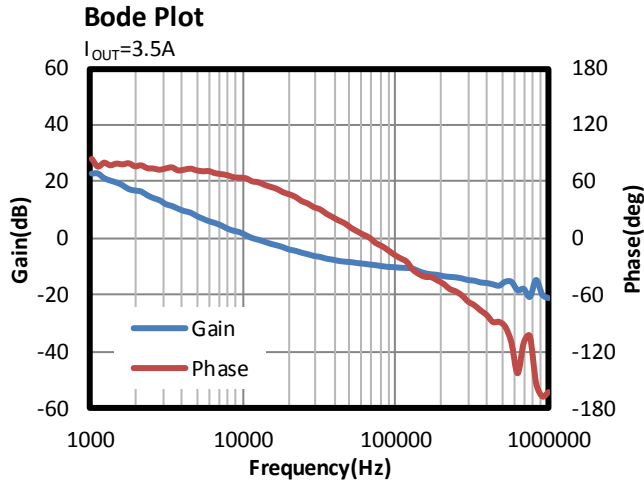

**TYPICAL PERFORMANCE CHARACTERISTICS (continued)**

V<sub>IN</sub> = 3.3V, V<sub>OUT</sub> = 9V, L = 1.5μH, I<sub>OUT</sub> = 3.5A, USM, T<sub>A</sub> = 25°C, unless otherwise noted.

**Steady State**

I<sub>OUT</sub> = 0A, USM

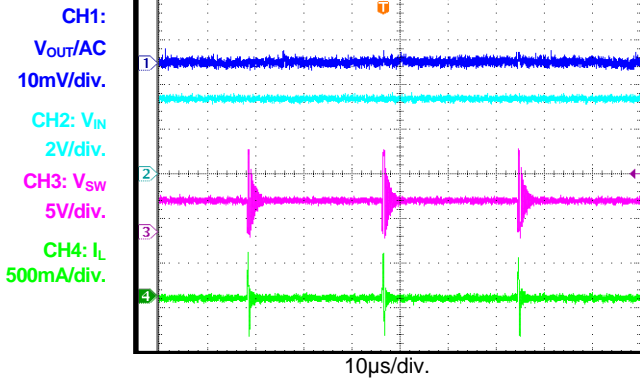

**Steady State**

I<sub>OUT</sub> = 0A, PSM

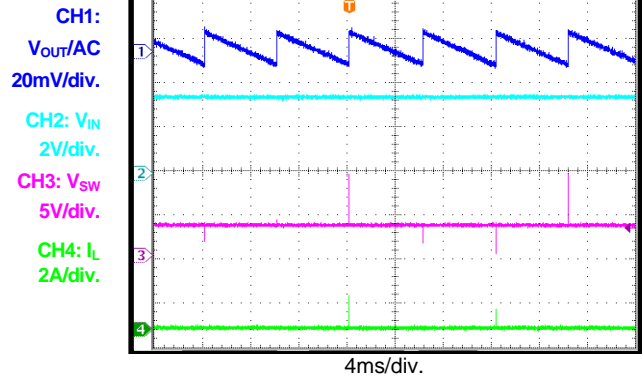

**Steady State**

I<sub>OUT</sub> = 0A, FCCM

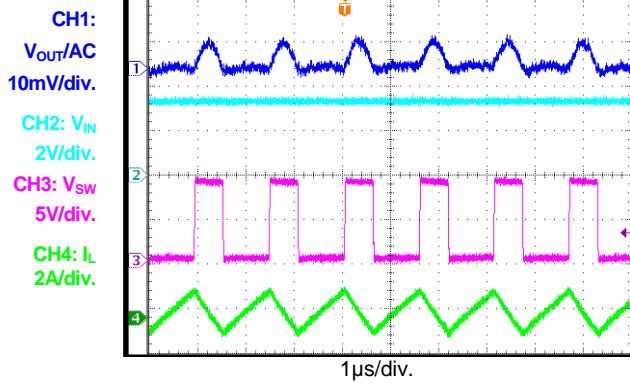

**Steady State**

I<sub>OUT</sub> = 3.5A

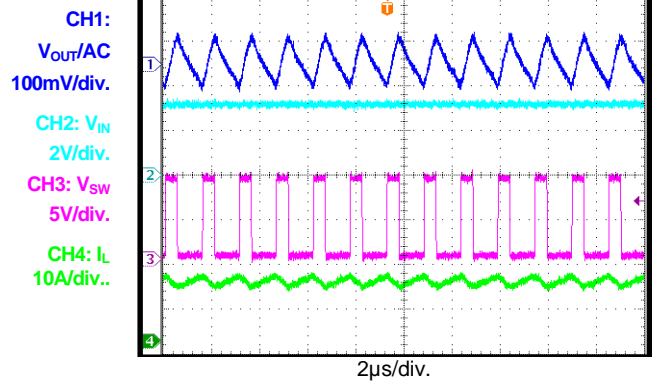

**V<sub>IN</sub> Start-Up**

I<sub>OUT</sub> = 0A

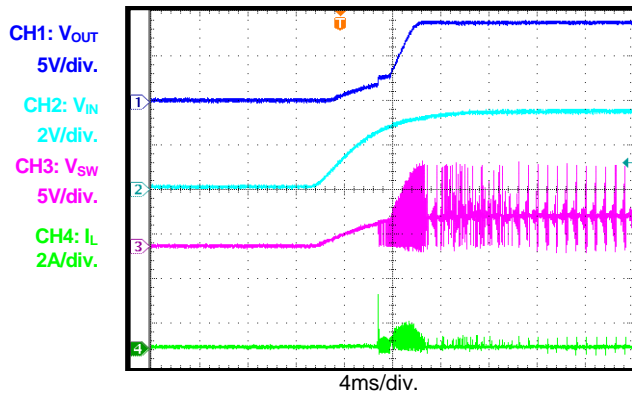

**V<sub>IN</sub> Start-Up**

I<sub>OUT</sub> = 3.5A

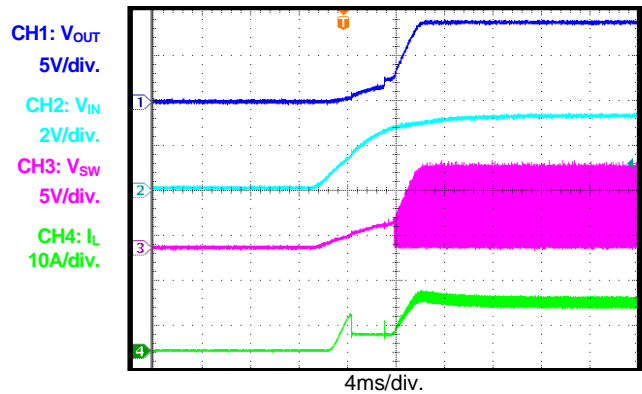

**TYPICAL PERFORMANCE CHARACTERISTICS (continued)**

V<sub>IN</sub> = 3.3V, V<sub>OUT</sub> = 9V, L = 1.5μH, I<sub>OUT</sub> = 3.5A, USM, T<sub>A</sub> = 25°C, unless otherwise noted.

**VIN Shutdown**

I<sub>OUT</sub> = 0A

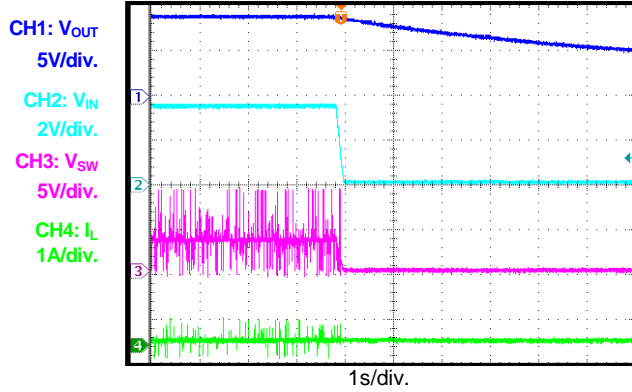

**VIN Shutdown**

I<sub>OUT</sub> = 3.5A

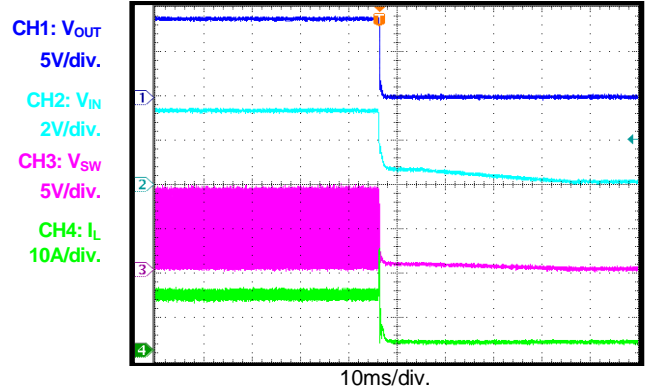

**EN Start-Up**

I<sub>OUT</sub> = 0A

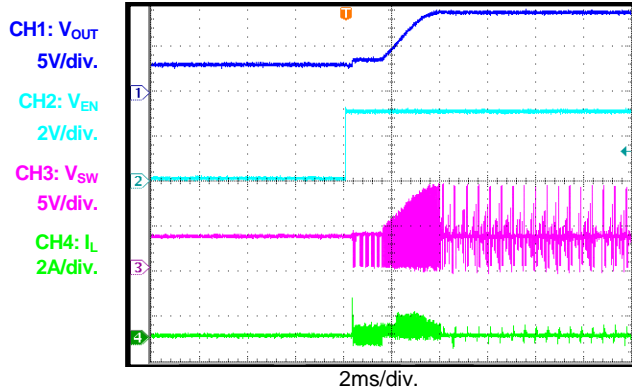

**EN Start-Up**

I<sub>OUT</sub> = 3.5A

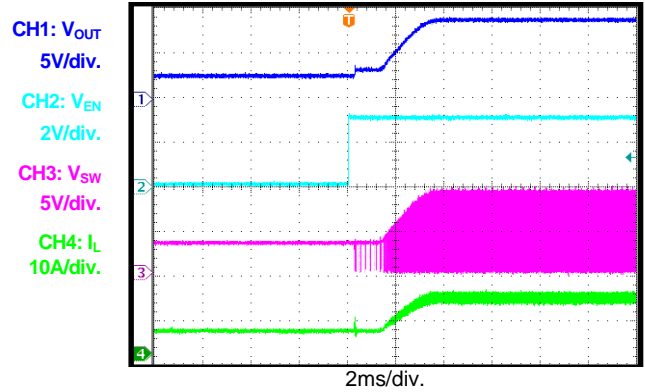

**EN Shutdown**

I<sub>OUT</sub> = 0A

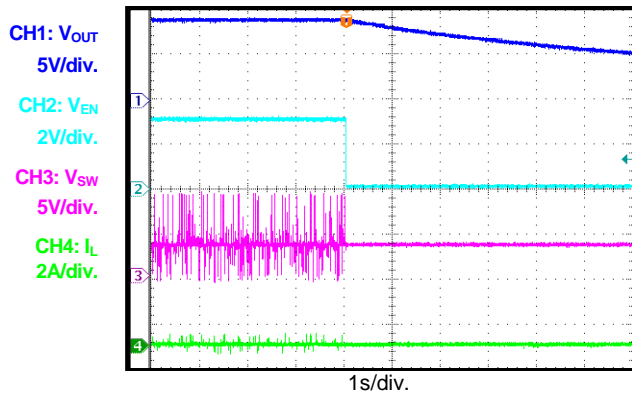

**EN Shutdown**

I<sub>OUT</sub> = 3.5A

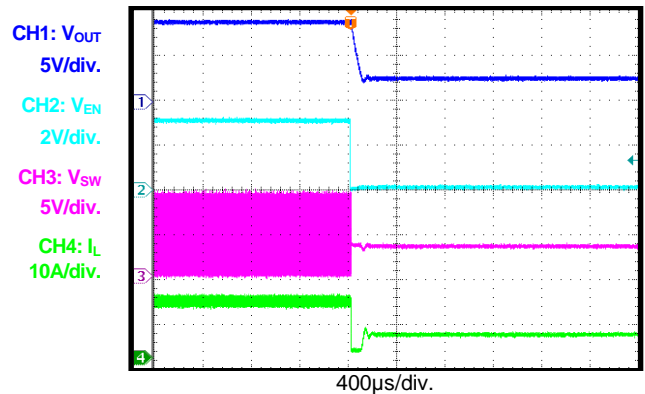

**TYPICAL PERFORMANCE CHARACTERISTICS (continued)**

VIN = 3.3V, VOUT = 9V, L = 1.5μH, IOUT = 3.5A, USM, TA = 25°C, unless otherwise noted.

**Load Transient**

IOUT = 0 - 1.75A, IRAMP = 25mA/μs, USM

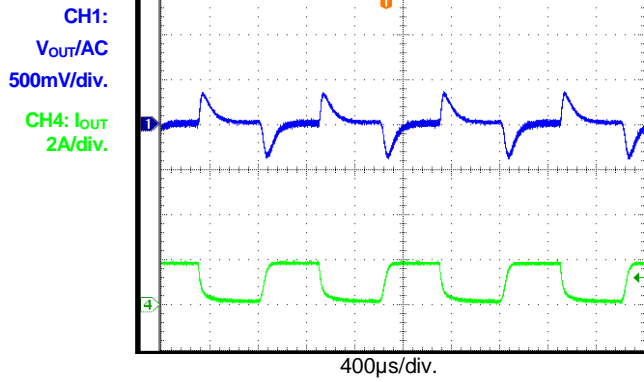

**Load Transient**

IOUT = 3.5 - 1.75A, IRAMP = 25mA/μs

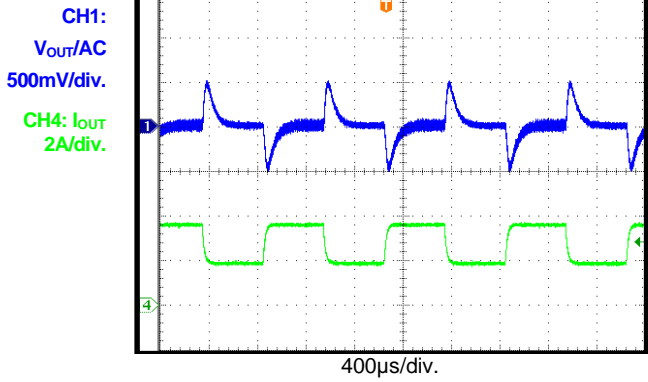

**Load Transient**

IOUT = 0 - 1.75A, IRAMP = 25mA/μs, PSM

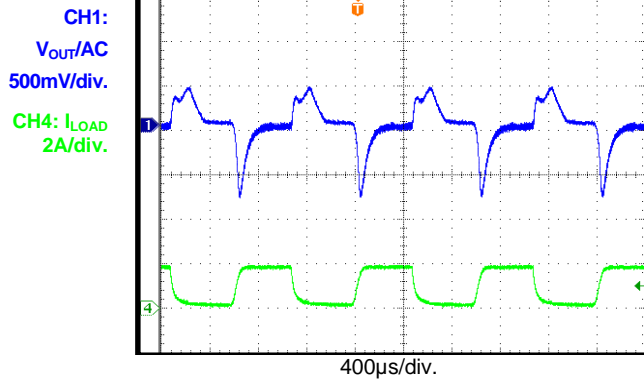

**Load Transient**

IOUT = 0 - 1.75A, IRAMP = 25mA/μs, FCCM

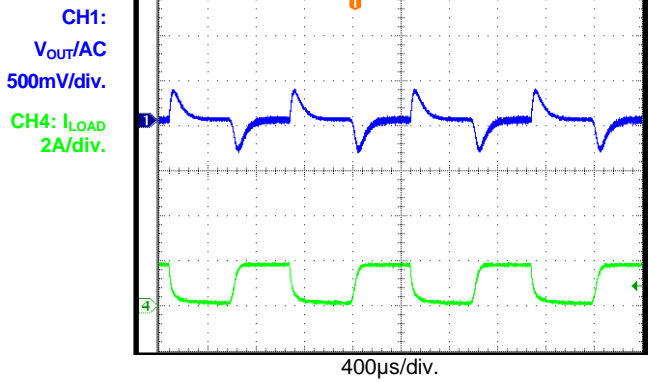

## PIN FUNCTIONS

Pin #	Name	Description
1	SW	<b>Converter switch.</b> SW is connected to the drain of the internal low-side power MOSFET and the source of the internal high-side synchronous power MOSFET. Connect the power inductor to SW.
2	VDD	<b>Internal bias supply.</b> Decouple VDD with a 4.7 $\mu$ F ceramic capacitor placed as close to VDD as possible. When VIN is higher than 3.4V, VDD is powered by VIN. Otherwise, VDD is powered by the higher voltage of either VIN or VOUT. If the bias voltage connected to VDD is higher than 3.4V, the regulator from VIN and VOUT is disabled. The VDD regulator starts working when VIN is higher than about 0.9V if EN is high. Supply VIN with a power source higher than 2.7V during VIN start-up to provide enough VDD power voltage.
3	SS	<b>Soft-start programming.</b> Place a capacitor from SS to AGND to set the VOUT rising slew rate.
4	COMP	<b>Internal error amplifier output.</b> Connect a capacitor and resistor in series from COMP to AGND for loop compensation.
5	FB	<b>Feedback input.</b> Connect a resistor divider from VOUT to FB.
6	AGND	<b>Analog ground.</b>
7	PGND	<b>Power ground.</b>
8	VOUT	<b>Output.</b> VOUT is connected to the drain of the high-side MOSFET. VOUT powers VDD when VOUT is higher than VIN and VIN is lower than 3.4V.
9	FTY	<b>Factory use only.</b> FTY must be connected to GND in the application.
10	MODE	<b>MODE selection.</b> If MODE is floating, the MP3429 works in ultrasonic mode (USM). If MODE is high, the MP3429 works in forced continuous conduction mode (FCCM). If MODE is low, the MP3429 works in pulse-skip mode (PSM). MODE must always be higher than 0.2V in the application, even if in PSM. Place a 130k $\Omega$ + 20k $\Omega$ resistor divider from VDD to MODE to set the MP3429 in PSM.
11	EN	<b>Chip enable control.</b> When not in use, connect EN to VIN for automatic start-up. EN can program the VIN UVLO. Do not leave EN floating.
12	VIN	<b>Input supply.</b> VIN must be bypassed locally. Supply VIN with a power source higher than 2.7V during VIN start-up to provide enough VDD power voltage.
13	BST	<b>Bootstrap.</b> A capacitor between BST and SW powers the synchronous HS-FET.

**BLOCK DIAGRAM**

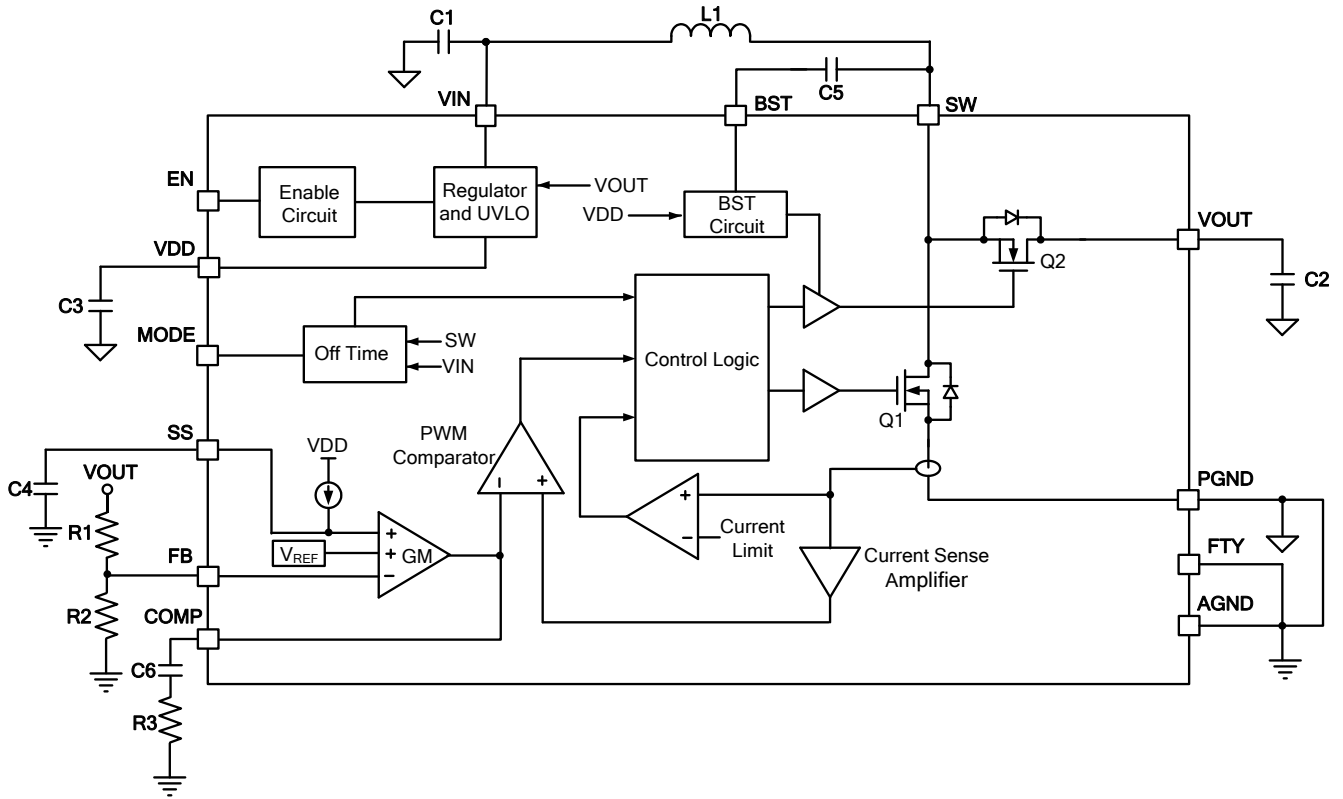

**Figure 1: Functional Block Diagram**

## OPERATION

The MP3429 is a 600kHz, fixed-frequency, high-efficiency, wide input range, boost converter. Its fully integrated low  $R_{DS(ON)}$  MOSFETs provide small size and high efficiency for high-power step-up applications. CONSTANT-off-time (COT) control provides fast transient response, while MODE selection provides flexible light-load performance design.

### Boost Operation

The MP3429 uses COT control to regulate the output voltage. At the beginning of each cycle, the low-side N-channel MOSFET (LS-FET) Q1 is turned on, forcing the inductor current to rise. The current through the LS-FET is sensed. If the current signal rises above the COMP voltage ( $V_{COMP}$ ), which is an amplifier output comparing the feedback voltage ( $V_{FB}$ ) against the internal reference voltage, the pulse-width modulation (PWM) comparator flips and turns the LS-FET off. Then the inductor current flows to the output capacitor through the high-side switch MOSFET (HS-FET), causing the inductor current to decrease. After a fixed off-time, the LS-FET turns on again and the cycle is repeated. In each cycle, the LS-FET off-time is determined by the VIN/VOUT ratio, and the on-time is controlled by  $V_{COMP}$ , so the inductor peak current is controlled by COMP, which itself is controlled by the output voltage. Therefore, the inductor current regulates the output voltage.

### Operation Mode

The MP3429 works with a 600kHz quasi-constant frequency with PWM control in heavy-load condition. When the load current decreases, the MP3429 can work in forced continuous conduction mode (FCCM), pulse-skip mode (PSM), or ultrasonic mode (USM) based on the MODE setting.

#### **Forced Continuous Conduction Mode (FCCM)**

The MP3429 works in a fixed-frequency PWM mode for any load condition if MODE is set high (>1.6V). In this condition, the off time is determined by the internal circuit to achieve the 600kHz frequency based on the VIN/VOUT ratio. When the load decreases, the average input current drops, and the inductor current from VOUT to VIN may become negative during the

off-time (LS-FET is off and HS-FET is on). This forces the inductor current to work in continuous conduction mode (FCCM) with a fixed frequency, producing a lower VOUT ripple than in PSM.

#### **Pulse-Skip Mode (PSM)**

The MP3429 works in PSM in light-load condition if the MODE voltage is low ( $0.2V < V_{MODE} < 0.7V$ ). In this condition, once the inductor current drops to 0A, the HS-FET turns off to stop current flowing from VOUT to VIN, forcing the inductor current to work in discontinuous conduction mode (DCM). At the same time, the internal off time becomes longer once the MP3429 enters DCM. The off time is inversely proportional to the HS-FET on period in each cycle. In deep DCM conditions, the MP3429 slows down the switching frequency and saves power loss.

If  $V_{COMP}$  drops to 0.5V of the PSM threshold, the MP3429 stops switching to decrease the switching power loss further. Switching resumes once  $V_{COMP}$  rises above 0.5V. The switching pulse skips based on  $V_{COMP}$  in very light-load conditions. PSM has much higher efficiency than FCCM in light load, but the VOUT ripple may be higher, and the frequency may go down and produce audible noise.

In DCM, frequency is low, and the LS-FET will not turn on in the prolonged off time. If the load increases and COMP runs higher, the off time shortens, and the MP3429 returns to the 600kHz fixed-frequency regularly, so the loop can respond to a high load current.

#### **Ultrasonic Mode (USM)**

To prevent audible noise with a switching frequency lower than 20kHz in PSM, the MP3429 implements USM by floating MODE or setting MODE in the USM range ( $0.9V < V_{MODE} < 1.2V$ ). In USM, the inductor current works in DCM, and the frequency stretches as if in PSM when the load decreases to a moderate level. However, the switching does not stop when COMP drops to the 0.5V PSM threshold. The LS-FET on time is controlled by COMP, even if  $V_{COMP}$  is lower than the PSM threshold, unless it triggers the minimum on time.

The MP3429 continues decreasing the switching frequency if the load is still decreasing. Once the MP3429 detects that the LS-FET is off for 30 $\mu$ s,

it forces the LS-FET on. This limits the frequency, avoiding audible frequency in light-load or no-load condition.

USM may convert more energy to the output than the required load due to the minimum 23kHz frequency, which causes V<sub>OUT</sub> to rise above the normal voltage setting. When V<sub>OUT</sub> rises and V<sub>COMP</sub> drops, the inductor peak current may drop as well. If V<sub>COMP</sub> drops below one internal clamped level, the HS-FET zero-current detection (ZCD) threshold is regulated to one negative level gradually, so the energy in the inductor can flow back to VIN in each cycle. This keeps the output at the setting voltage with a >23kHz frequency. The MP3429 also works with a 600kHz frequency if V<sub>COMP</sub> rises again.

USM has the same efficiency as in PSM if the frequency is higher than the typical 33kHz. USM has more power loss than PSM if the frequency is clamped at the typical 33kHz, but USM does not introduce audible noise caused by the group pulse in PSM.

#### Minimum On Time and Minimum Off Time

The MP3429 blanks the LS-FET on state with 80ns in each cycle to enhance noise immunity. This 80ns minimum on time restricts applications with a high VIN/V<sub>OUT</sub> ratio. The MP3429 also blanks the LS-FET off state with a minimum off time in each cycle. During the minimum off time, the LS-FET cannot turn on, and the minimum off time is short enough to convert the 0.8V input to 16V.

#### LS-FET and HS-FET Maximum On Time

If the inductor current cannot trigger V<sub>COMP</sub> with an on time of 7.5μs, the MP3429 shuts down the LS-FET. After the LS-FET is shut down, the inductor current goes through the HS-FET and charges V<sub>OUT</sub> in the off-time period. This helps refresh V<sub>OUT</sub> with a minimum frequency of about 133kHz in heavy-load transient conditions.

During CCM condition, the HS-FET on time is limited below 8μs. This helps limit the maximum LS-FET off time when V<sub>OUT</sub> is close to VIN in USM. In USM or heavy-load PSM, if VIN is too close to V<sub>OUT</sub>, the HS-FET may be turned off by the 8μs HS-FET maximum on time because the inductor current cannot ramp down within this 8μs limit. After the HS-FET turns off, the LS-FET turns on immediately with one pulse control by

V<sub>COMP</sub>, and the HS-FET turn on again. This makes the LS-FET work in a quasi-constant minimum duty cycle. If VIN is high enough, V<sub>OUT</sub> is higher than the setting voltage with this duty cycle ratio. In PSM and light load, the IC works with normal PSM logic. The IC stops working when V<sub>OUT</sub> is higher than the setting voltage and resumes switching when V<sub>OUT</sub> drops below the setting voltage.

#### VDD Power

The MP3429 internal circuit is powered by VDD. A ceramic capacitor no less than 4.7μF is required on VDD. When VIN is lower than 3.4V, VDD is powered from the higher value of either VIN or V<sub>OUT</sub>. This allows the MP3429 to maintain a low R<sub>DS(ON)</sub> and high efficiency, even with a low input voltage. When VIN is higher than 3.4V, VDD is always powered by VIN. This decreases the V<sub>OUT</sub> to VDD regulator loss, because V<sub>OUT</sub> is always higher than VIN.

If VDD is powered by an external supply, and the voltage is higher than 3.4V, the regulators from VIN and V<sub>OUT</sub> are disabled. In this condition, the MP3429 starts once the external VDD power supply is higher than VDD<sub>UVLO</sub>, even if VIN is as low as 0.9V. When VDD is powered by the external power supply, the MP3429 continues working, even if both VIN and V<sub>OUT</sub> are dropping but are higher than 0.8V. The external VDD power source should be limited within 3.6V.

There is a reverse-blocking circuit to limit the current flowing between VIN and V<sub>OUT</sub>. If the external VDD power is higher than the VDD regulation voltage, the current is supplied from the external power, and there is no path for the current from VDD to VIN or from VDD to V<sub>OUT</sub>.

VDD is charged when VIN is higher than about 0.9V and EN is higher than the micro-power threshold. If EN is low, VDD is disconnected from VIN and V<sub>OUT</sub>. Supply VIN with a power source higher than 2.7V during VIN start-up to provide enough VDD power voltage.



### Start-Up

When the MP3429 input is powered, it starts charging VDD from VIN. Once VDD rises above its UVLO threshold and EN is high, the MP3429 starts switching with closed loop control. If VDD is powered by an additional supply, the MP3429 starts switching once VDD rises above its under-voltage lockout (UVLO) threshold.

After the IC is enabled, the MP3429 starts up with a soft-start (SS) control. The SS signal is controlled by charging SS from 0V and compared with the internal reference voltage. The lower value is fed to the error amplifier to control the output voltage. After the SS signal rises above the reference voltage, soft start is completed, and the internal reference takes charge of the feedback loop regulation.

If there is some bias voltage on VOUT during PSM, the MP3429 stops switching until the SS signal rises above V<sub>FB</sub>, which is proportional to the VOUT bias voltage. If the IC is in USM or FCCM, the MP3429 works with a frequency of about 33kHz or 600kHz. Both USM and FCCM have a negative inductor current, so the energy may transfer from VOUT to VIN if the VOUT bias is high.

### Synchronous Rectifier and BST Function

The MP3429 integrates both an LS-FET Q1 and HS-FET Q2 to reduce external components. During switching, the rectifier switch Q2 is powered from BST (typically 3.4V higher than the SW voltage). This 3.4V bootstrap voltage is charged from VDD when the LS-FET turns on.

### Switching Current Limit

The MP3429 provides a fixed cycle-by-cycle switching peak current limit. In each cycle, the internal current sensing circuit monitors the LS-FET current signal. Once the sensed current reaches the typical 21.5A current limit, the LS-FET Q1 turns off. The LS-FET current signal is blanked for about 80ns internally to enhance noise immunity.

### Enable (EN) and Programmable UVLO

EN enables and disables the MP3429. When applying a voltage higher than the EN high threshold (1V max threshold), the MP3429 starts up some of the internal circuits (micro-power mode). If the EN voltage exceeds the turn-on threshold (1.23V), the MP3429 enables all

functions and starts boost operation. Boost switching is disabled when the EN voltage falls below its turn-on threshold (1.23V). To completely shut down the MP3429, a <0.4V low-level voltage is required on EN. After shutdown, the MP3429 sinks a current from the input power (typically less than 2μA). EN is compatible with voltages up to 13V. For automatic start-up, connect EN to VIN directly.

The MP3429 features a programmable UVLO hysteresis. When powering up in micro-power mode, EN sinks a 5μA current from an upper resistor (R<sub>TOP</sub>) (see Figure 2).

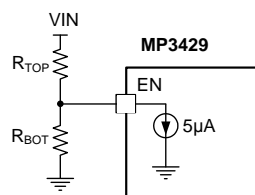

**Figure 2: VIN UVLO Program**

VIN must increase to overcome the current sink. The VIN start-up threshold is determined by Equation (1):

$$V_{IN-ON} = V_{EN-ON} \times \left(1 + \frac{R_{TOP}}{R_{BOT}}\right) + 5\mu A \times R_{TOP} \quad (1)$$

Where V<sub>EN-ON</sub> is the EN voltage turn-on threshold (1.23V, typically).

Once the EN voltage reaches V<sub>EN-ON</sub>, the 5μA sink current turns off to create a reverse hysteresis for the VIN falling threshold, which can be calculated with Equation (2):

$$V_{IN-UVLO-HYS} = 5\mu A \times R_{TOP} \quad (2)$$

### Over-Voltage Protection (OVP)

If over-voltage is detected from VOUT with a 16.5V threshold (typically), the MP3429 stops switching immediately until the voltage drops to 16.3V. This prevents over-voltage on the output and internal power MOSFETs.

### Thermal Protection

Thermal shutdown prevents the IC from operating at exceedingly high temperatures. When the die temperature exceeds 150°C, the IC shuts down and resumes normal operation when the die temperature drops to 25°C.

## APPLICATION INFORMATION

### Setting the Output Voltage

The external resistor divider is used to set the output voltage. Typically, choose R1 to be between 300 - 800kΩ. Then calculate R2 with Equation (3):

$$R2 = \frac{V_{REF}}{V_{OUT} - V_{REF}} \times R1 \quad (3)$$

Where  $V_{REF}$  is 1V, R1 is the top feedback resistor, and R2 is the bottom feedback resistor.

### Selecting the Input Capacitor

The input capacitor (C1) is used to maintain the DC input voltage. Low ESR ceramic capacitors are recommended. The input voltage ripple can be estimated with Equation (4):

$$\Delta V_{IN} = \frac{V_{IN}}{8f_s^2 \cdot L \cdot C1} \cdot \left(1 - \frac{V_{IN}}{V_{OUT}}\right) \quad (4)$$

Where  $f_s$  is the switching frequency, and L is the inductor value.

### Selecting the Output Capacitor

The output current to the boost converter is discontinuous and therefore requires an output capacitor (C2) to supply AC current to the load. For the best performance, low ESR ceramic capacitors are recommended. The output voltage ripple can be estimated with Equation (5):

$$\Delta V_{OUT} = \frac{V_{OUT}}{f_s \cdot R_L \cdot C2} \cdot \left(1 - \frac{V_{IN}}{V_{OUT}}\right) \quad (5)$$

Where  $R_L$  is the value of the load resistor.

Ceramic capacitors with X5R or X7R dielectrics are highly recommended because of their low ESR and small temperature coefficients.

### Selecting the Inductor

An inductor is required to transfer energy between the input source and the output capacitors. An inductor with a larger value results in less ripple current and a lower peak inductor current, reducing stress on the power MOSFET. However, the larger value inductor has a larger physical size, a higher series resistance, and a lower saturation current.

For most designs, the inductance value can be calculated with Equation (6):

$$L = \frac{V_{IN}(V_{OUT} - V_{IN})}{f_s \cdot V_{OUT} \cdot \Delta I_L} \quad (6)$$

Where  $\Delta I_L$  is the inductor ripple current.

Choose the inductor ripple current to be approximately 20 ~ 50% of the maximum inductor peak current. Typically, a 1.5μH inductor is recommended. Ensure that the inductor does not saturate under the worst-case condition. The inductor should have a low series resistance (DCR) to reduce resistive power loss.

### Soft-Start (SS) Capacitor Selection

With the required output voltage rising time ( $T_{RISE}$ ), the value of  $C_{SS}$  can be calculated using Equation (7):

$$C_{SS} = \frac{T_{RISE} \times I_{SS}}{V_{REF}} \quad (7)$$

Where  $I_{SS}$  is the SS charging current (7.5μA). Typically, set  $C_{SS}$  to be 22nF for about 3ms of the rising time.

### VDD Capacitor Selection

The MP3429 integrates the VDD power at about 3.4V, which powers the internal MOSFET gate driver and internal control circuit, typically. One ceramic bypass capacitor 4.7μF or higher is necessary for the internal regulator. Do not connect the external load to the VDD power.

### BST Capacitor

The MP3429 uses one bootstrap circuit to power the output N-channel MOSFET. One external bootstrap capacitor is necessary for the charge pump power. A 0.1μF ceramic capacitor between BST and SW is recommended.

### Programmable UVLO

The MP3429 features a programmable UVLO hysteresis. When powering up, EN sinks a 5μA current from an upper resistor ( $R_{TOP}$ ) (see Figure 2).  $V_{IN}$  must increase to overcome the current sink.

Determine the VIN start-up threshold with Equation (8):

$$V_{IN-ON} = V_{EN-ON} \times \left(1 + \frac{R_{TOP}}{R_{BOT}}\right) + 5\mu A \times R_{TOP} \quad (8)$$

Where V<sub>EN-ON</sub> is the EN voltage turn-on threshold (typically 1.23V).

Once the EN voltage reaches V<sub>EN-ON</sub>, the 5μA sink current turns off to create a reverse hysteresis for the VIN falling threshold, which can be calculated with Equation (9):

$$V_{IN-UVLO-HYS} = 5\mu A \times R_{TOP} \quad (9)$$

For automatic start-up, connect EN with a 30kΩ R<sub>TOP</sub> resistor to operate with 150mV hysteresis.

**MODE Selection**

The MP3429 can work in forced continuous conduction mode (FCCM), pulse-skip mode (PSM), or ultrasonic mode (USM) based on the MODE setting. Pull MODE to VDD directly for FCCM; float MODE for USM; pull the MODE voltage to 0.2 - 0.7V to make the MP3429 work in PSM. With no appropriate voltage for the PSM threshold, a resistor divider from VDD to GND can be used (see Figure 3).

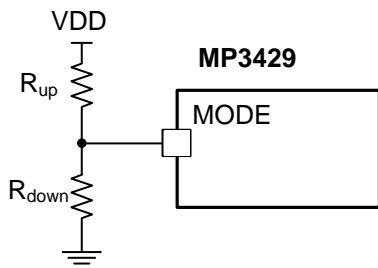

**Figure 3: MODE Setting**

The typical VDD voltage range is 2V to 3.3V. Set R<sub>up</sub> to 130kΩ and R<sub>down</sub> to 20kΩ to achieve a 267 - 450mV voltage on MODE. When MODE is pulled below 1V, a current less than 2μA flows out of MODE. A 20kΩ R<sub>BOT</sub> causes a 40mV MODE voltage increase. The ideal MODE voltage is about 307 - 490mV.

**Compensation**

The output of the transconductance error amplifier (COMP) is used to compensate for the regulation control system. The system uses two poles and one zero to stabilize the control loop.

The pole F<sub>P1</sub> is set by the output capacitor (C<sub>OUT</sub>) and the load resistance. Pole F<sub>P2</sub> starts from the origin. The zero F<sub>Z1</sub> is set by the compensation capacitor (C<sub>COMP</sub>) and the compensation resistor (R<sub>COMP</sub>). These are determined by Equation (10) and Equation (11):

$$F_{P1} = \frac{1}{2 \times \pi \times R_{LOAD} \times C_{OUT}} \text{ (Hz)} \quad (10)$$

$$F_{Z1} = \frac{1}{2 \times \pi \times R_{COMP} \times C_{COMP}} \text{ (Hz)} \quad (11)$$

Where R<sub>LOAD</sub> is the load resistance.

There is a right-half-plane zero (F<sub>RHPZ</sub>) that exists in FCCM, where the inductor current does not drop to zero in each cycle. The frequency of the right-half-plane zero can be determined with Equation (12):

$$F_{RHPZ} = \frac{R_{LOAD}}{2 \times \pi \times L} \times \left(\frac{V_{IN}}{V_{OUT}}\right)^2 \text{ (Hz)} \quad (12)$$

The right-half-plane zero increases the gain and reduces the phase simultaneously, which results in a smaller phase margin and gain margin. The worst-case scenario occurs at the condition of the minimum input voltage and maximum output power.

### PCB Layout Guidelines

Efficient PCB layout is critical for high-frequency switching power supplies. A poor layout can result in reduced performance, excessive EMI, resistive loss, and system instability. Use a 4-layer PCB for high-power applications. For best results, refer to Figure 4 and follow the guidelines below.

1. Place the output capacitor (C2A ~ C2C) as close to VOUT and PGND as possible.
2. Place a 0.1µF capacitor close to the IC (C2D) to reduce the PCB parasitical inductance.
3. Place the FB divider R1 and R2 as close to FB as possible.
4. Keep the FB trace far away from noise sources, such as the SW node.
5. Connect the compensation components and SS capacitor to AGND with a short loop.
6. Connect the VDD capacitor to PGND with a short loop.
7. Keep the input loop (C1, L1, SW, and PGND) as small as possible.
8. Place enough GND vias close to the MP3429 for good thermal dissipation.
9. Use separated AGND and PGND layouts, connected them between the AGND and PGND pins under the package.

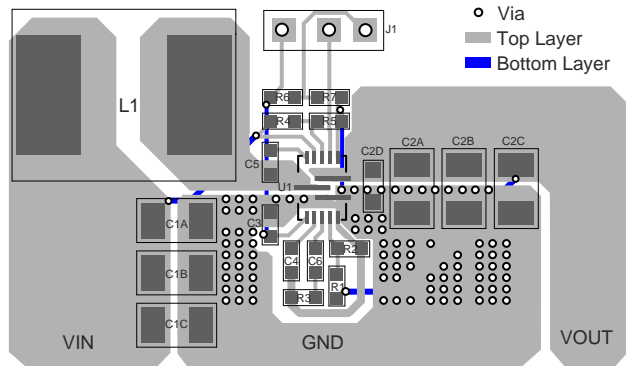

**Figure 4: Recommended Layout**

### Design Example

Table 1 shows a design example following the application guidelines for the specifications below.

**Table 1: Design Example**

$V_{IN}$	2.7 - 8.4V
$V_{OUT}$	9V
$I_{OUT (continuous)}$	3A <sup>(14)</sup>
$I_{OUT (peak)}$	3.5A

The detailed application schematic is shown in Figure 5. The typical performance and circuit waveforms are shown in the Typical Performance Characteristics section. For more device applications, please refer to related evaluation board datasheet.

**NOTE:**

- 14) The MP3429 temperature may be high when  $V_{IN}$  is 2.7V and the load is 3A. Decrease the load based on the permitted temperature performance when  $V_{IN}$  is too low.

**TYPICAL APPLICATION CIRCUIT**

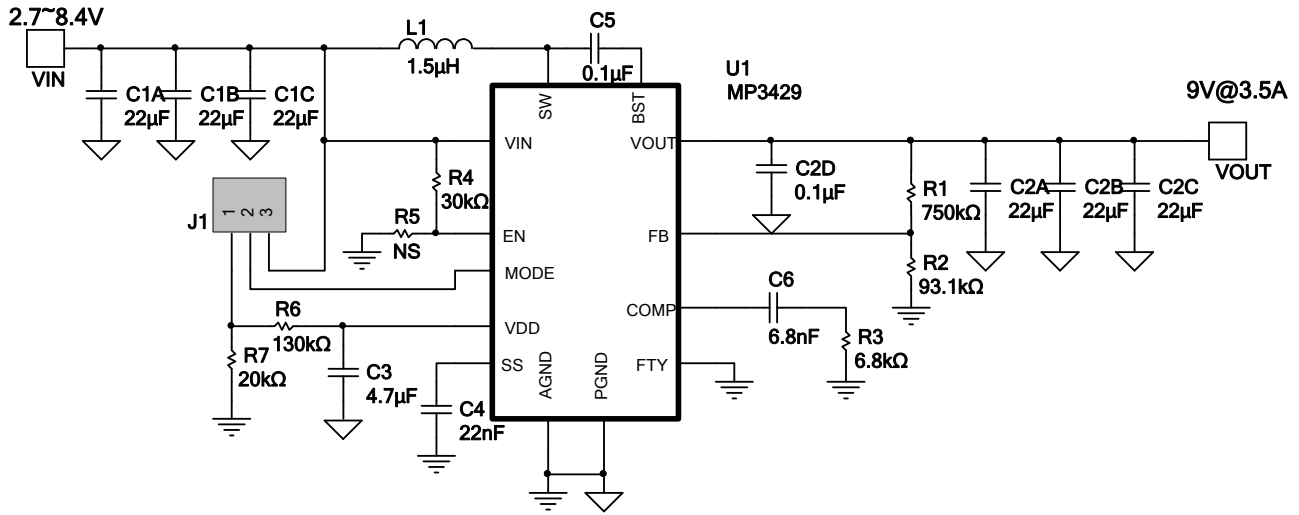
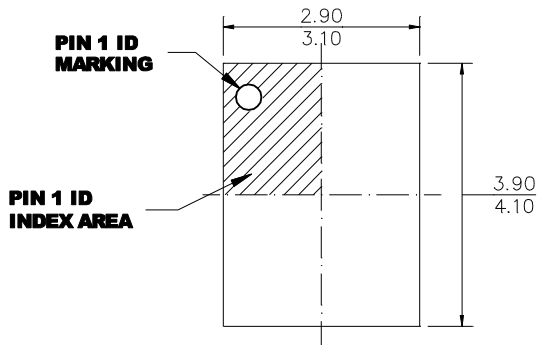

Figure 5:  $V_{IN} = 2.7 - 8.4V$ ,  $V_{OUT} = 9V$ ,  $I_{OUT} = 3.5A$

**PACKAGE INFORMATION**

**QFN-13 (3mmx4mm)**



**TOP VIEW**

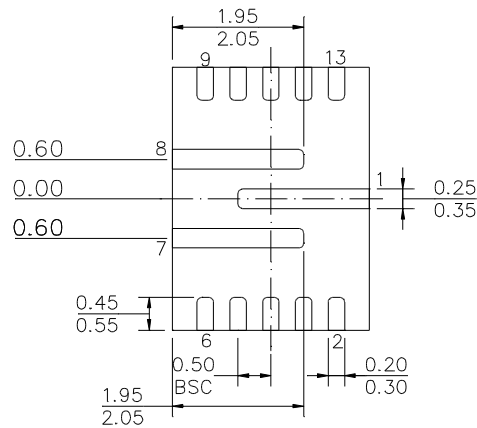

**BOTTOM VIEW**

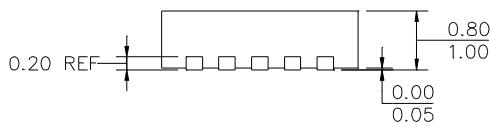

**SIDE VIEW**

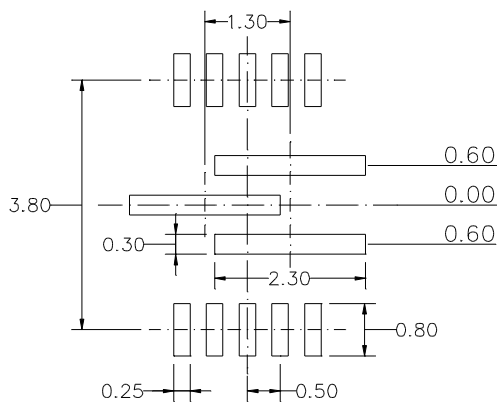

**RECOMMENDED LAND PATTERN**

**NOTE:**

- 1) LAND PATTERNS OF PIN,7 AND 8 HAVE THE SAME LENGTH AND WIDTH
- 2) ALL DIMENSIONS ARE IN MILLIMETERS
- 3) LEAD COPLANARITY SHALL BE  $\leq 0.10$  MILLIMETERS MAX.
- 4) JEDEC REFERENCE IS M0220.
- 5) DRAWING IS NOT TO SCALE

**NOTICE:** The information in this document is subject to change without notice. Users should warrant and guarantee that third party Intellectual Property rights are not infringed upon when integrating MPS products into any application. MPS will not assume any legal responsibility for any said applications.