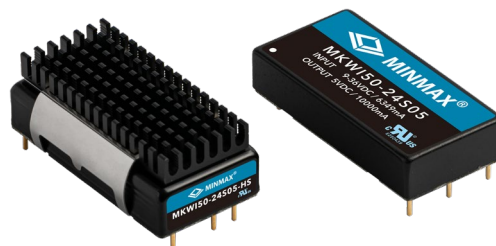

**FEATURES**

- ▶ Smallest Encapsulated 50W Converter
- ▶ Compact Size of 2" X 1" Package
- ▶ Ultra-wide 4:1 Input Voltage Range
- ▶ Fully Regulated Output Voltage
- ▶ Excellent Efficiency up to 92%
- ▶ I/O Isolation 1500 VDC
- ▶ Operating Ambient Temp. Range -40°C to +80°C
- ▶ No Min. Load Requirement
- ▶ Overload/Voltage/Temp. and Short Circuit Protection
- ▶ Remote On/Off Control, Output Voltage Trim
- ▶ Shielded Metal Case with Insulated Baseplate
- ▶ UL/cUL/IEC/EN 62368-1(60950-1) Safety Approval & CE Marking

**PRODUCT OVERVIEW**

The MINMAX MKW150 series is the generation of high-performance DC-DC converter modules setting a new standard concerning power density. The product offers fully 50W in an encapsulated, shielded metal package with dimensions of just 2.0"x1.0"x0.4". All models provide wide 4:1 input voltage range and precisely regulated output voltages.

A very high efficiency up to 92% which allows an operating temperature range of -40°C to +80°C is achieved by advanced circuit topology. Further features include remote On/Off, trimmable output voltage, under-voltage shutdown as well as overload and over-temperature protection.

Typical applications for these converters are battery operated equipment, instrumentation, distributed power architectures in communication and industrial electronics and many other space critical applications.

**Model Selection Guide**

Model Number	Input Voltage (Range) VDC	Output Voltage VDC	Output Current Max. mA	Input Current		Reflected Ripple Current mA(typ.)	Over Voltage Protection VDC	Max. capacitive Load µF	Efficiency (typ.) @Max. Load %
				@Max. Load mA(typ.)	@No Load mA(typ.)				
MKW150-24S033	24 (9 ~ 36)	3.3	10000	1528	80	40	3.9	26000	90
MKW150-24S05		5	10000	2290	60		6.2	17000	91
MKW150-24S12		12	4170	2267	80		15	3000	92
MKW150-24S15		15	3330	2263	80		18	2000	92
MKW150-24S24		24	2080	2286	80		30	750	91
MKW150-48S033	48 (18 ~ 75)	3.3	10000	764	40	30	3.9	26000	90
MKW150-48S05		5	10000	1145	30		6.2	17000	91
MKW150-48S12		12	4170	1134	60		15	3000	92
MKW150-48S15		15	3330	1134	60		18	2000	92
MKW150-48S24		24	2080	1143	50		30	750	91

**Input Specifications**

Parameter	Conditions / Model	Min.	Typ.	Max.	Unit
Input Surge Voltage (100ms. max)	24V Input Models	-0.7	---	50	VDC
	48V Input Models	-0.7	---	100	
Start-Up Threshold Voltage	24V Input Models	---	---	9	
	48V Input Models	---	---	18	
Under Voltage Lockout	24V Input Models	---	7.5	---	
	48V Input Models	---	16	---	
Input Polarity Protection	None				
Start Up Time	Power Up	---	---	30	ms
	Remote On/Off	Nominal Vin and Constant Resistive Load			30
Input Filter	All Models	Internal LC Type			

Remote On/Off Control						
Parameter	Conditions	Min.	Typ.	Max.	Unit	
Converter On	3.5V ~ 12V or Open Circuit					
Converter Off	0V ~ 1.2V or Short Circuit					
Control Input Current (on)	Vctrl = 5.0V	---	0.5	---	mA	
Control Input Current (off)	Vctrl = 0V	---	-0.5	---	mA	
Control Common	Referenced to Negative Input					
Standby Input Current	Nominal Vin	---	2.5	---	mA	

Output Specifications						
Parameter	Conditions / Model	Min.	Typ.	Max.	Unit	
Output Voltage Setting Accuracy		---	---	±1.0	%Vnom.	
Line Regulation	Vin=Min. to Max. @Full Load	---	---	±0.5	%	
Load Regulation	Min. Load to Full Load	---	---	±0.5	%	
Minimum Load	No minimum Load Requirement					
Ripple & Noise	0-20 MHz Bandwidth	3.3V & 5V Models <sup>(3)</sup>	---	---	100	mV <sub>P-P</sub>
		12V, 15V & 24V Models <sup>(3)</sup>	---	---	150	mV <sub>P-P</sub>
Transient Recovery Time	25% Load Step Change <sup>(2)</sup>	---	250	---	μsec	
Transient Response Deviation		---	±3	±5	%	
Temperature Coefficient		---	---	±0.02	%/°C	
Trim Up / Down Range (See Page 6 )	% of nominal output voltage (24Vo Models)	---	---	+20 / -10	%	
	% of nominal output voltage (Other Models)	---	---	±10	%	
Over Load Protection	Hiccup	---	150	---	%	
Short Circuit Protection	Continuous, Automatic Recovery (Hiccup Mode 0.3Hz typ.)					

General Specifications						
Parameter	Conditions	Min.	Typ.	Max.	Unit	
I/O Isolation Voltage	60 Seconds	1500	---	---	VDC	
	1 Seconds	1800	---	---	VDC	
I/O Isolation Resistance	500 VDC	1000	---	---	MΩ	
I/O Isolation Capacitance	100kHz, 1V	---	---	2200	pF	
Switching Frequency		---	285	---	kHz	
MTBF(calculated)	MIL-HDBK-217F@25°C, Ground Benign	230,900			Hours	
Safety Approvals	UL/cUL 60950-1 recognition(CSA certificate), IEC/EN 60950-1(CB-report)					
	UL/cUL 62368-1 recognition(UL certificate), IEC/EN 62368-1(CB-report)					

EMC Specifications					
Parameter	Standards & Level			Performance	
EMI <sub>(5)</sub>	Conduction	EN 55032	With external components	Class A	
	Radiation				
EMS <sub>(5)</sub>	EN 55024				
	ESD	EN 61000-4-2 air ± 8kV , Contact ± 6kV			A
	Radiated immunity	EN 61000-4-3 10V/m			A
	Fast transient	EN 61000-4-4 ±2kV			A
	Surge	EN 61000-4-5 ±1kV			A
	Conducted immunity	EN 61000-4-6 10Vrms			A

**Environmental Specifications**

Parameter	Conditions / Model	Min.	Max.		Unit
			without Heatsink	with Heatsink	
Operating Ambient Temperature Range Nominal Vin, Load 100% Inom. (for Power Derating see relative Derating Curves)	MKWI50-24S033, MKWI50-48S033	-40	61	69	°C
	MKWI50-24S12, MKWI50-24S15		53	62	
	MKWI50-48S12, MKWI50-48S15		46	57	
	MKWI50-24S05, MKWI50-24S24				
Thermal Impedance	20LFM Convection without Heatsink	12.1	---	---	°C/W
	20LFM Convection with Heatsink	9.8	---	---	°C/W
	100LFM Convection without Heatsink	9.2	---	---	°C/W
	100LFM Convection with Heatsink	5.4	---	---	°C/W
	200LFM Convection without Heatsink	7.8	---	---	°C/W
	200LFM Convection with Heatsink	4.5	---	---	°C/W
	400LFM Convection without Heatsink	5.2	---	---	°C/W
	400LFM Convection with Heatsink	3.0	---	---	°C/W
Case Temperature		---	+105		°C
Thermal Protection	Shutdown Temperature		110°C typ.		
Storage Temperature Range		-50	+125		°C
Humidity (non condensing)		---	95		% rel. H
RFI	Six-Sided Shielded, Metal Case				
Lead Temperature (1.5mm from case for 10Sec.)		---	260		°C

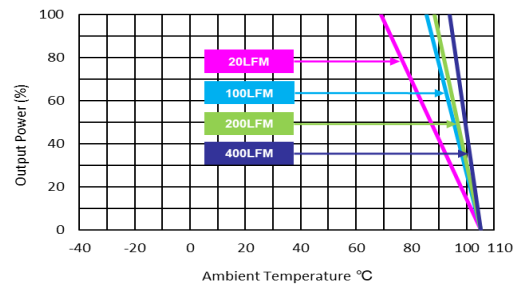
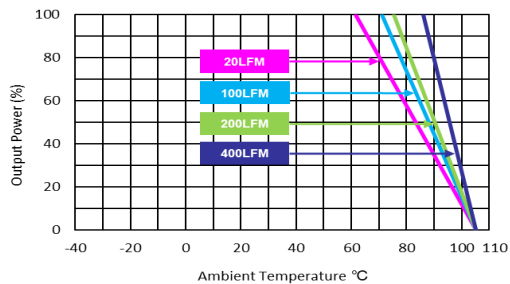
**Power Derating Curve**

MKWI50-24S033, MKWI50-48S033 Derating Curve without Heatsink

MKWI50-24S033, MKWI50-48S033 Derating Curve with Heatsink

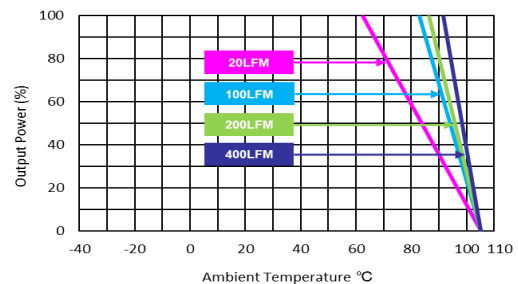
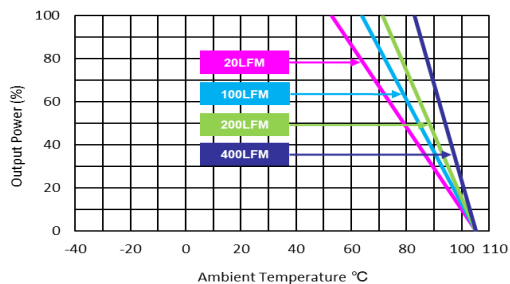

MKWI50-24S12, MKWI50-24S15, MKWI50-48S12, MKWI50-48S15 Derating Curve without Heatsink

MKWI50-24S12, MKWI50-24S15, MKWI50-48S12, MKWI50-48S15 Derating Curve with Heatsink

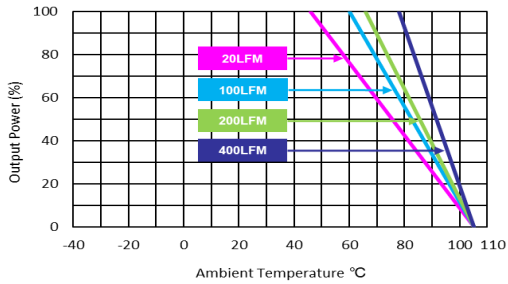
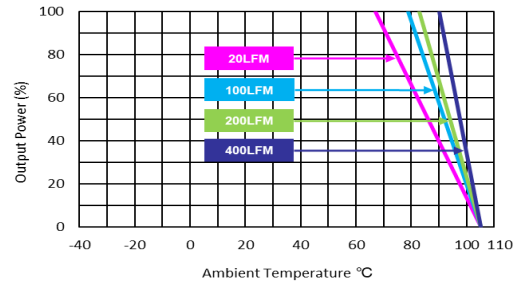
**Power Derating Curve**

 MKWI50-24S05, MKWI50-24S24, MKWI50-48S05, MKWI50-48S24  
 Derating Curve without Heatsink

 MKWI50-24S05, MKWI50-24S24, MKWI50-48S05, MKWI50-48S24  
 Derating Curve with Heatsink

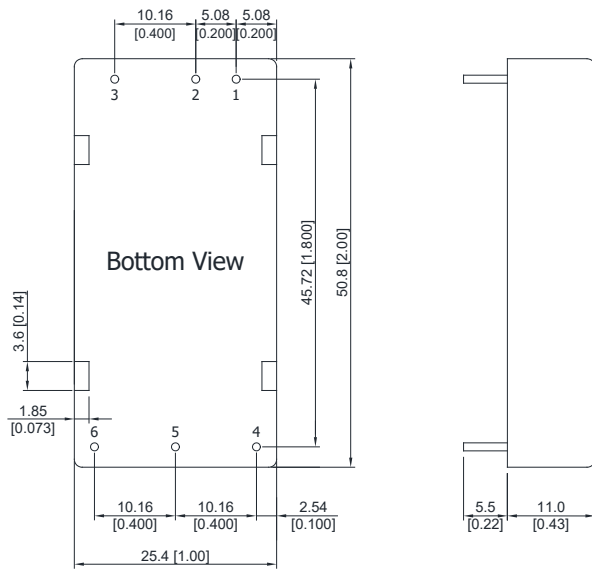
**Notes**

- 1 Specifications typical at  $T_a = +25^\circ\text{C}$ , resistive load, nominal input voltage, rated output current unless otherwise noted.
- 2 Transient recovery time is measured to within 1% error band for a step change in output load of 75% to 100%.
- 3 Ripple & Noise measurement with a  $1\mu\text{F}/50\text{V}$  MLCC and a  $10\mu\text{F}/50\text{V}$  Tantalum Capacitor.
- 4 We recommend to protect the converter by a slow blow fuse in the input supply line.
- 5 Other input and output voltage may be available, please contact MINMAX.
- 6 The external components might be required to meet EMI/EMS standard for some of test items. Please contact MINMAX for the solution in detail.
- 7 Do not exceed maximum power specification when adjusting output voltage.
- 8 Specifications are subject to change without notice.

**Package Specifications**
**Mechanical Dimensions**

**Pin Connections**

Pin	Function	Diameter mm (inches)
1	+Vin	Ø 1.0 [0.04]
2	-Vin	Ø 1.0 [0.04]
3	Remote On/Off	Ø 1.0 [0.04]
4	+Vout	Ø 1.0 [0.04]
5	-Vout	Ø 1.0 [0.04]
6	Trim	Ø 1.0 [0.04]

- ▶ All dimensions in mm (inches)
- ▶ Tolerance: X.X±0.25 (X.XX±0.01)  
X.XX±0.13 (X.XXX±0.005)
- ▶ Pin diameter tolerance: X.X±0.05 (X.XX±0.002)

**Physical Characteristics**

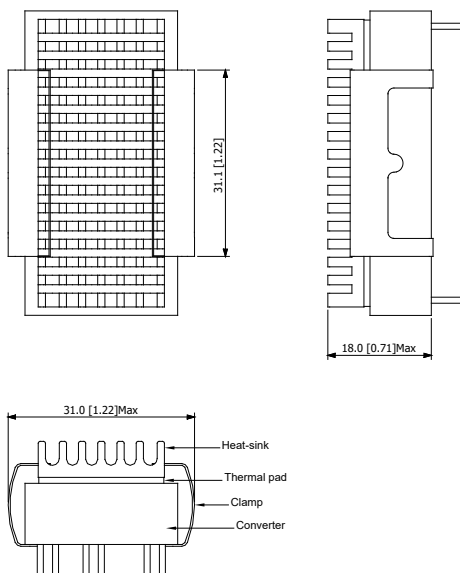
Case Size	: 50.8x25.4x11.0mm (2.0x1.0x0.43 inches)
Case Material	: Metal With Non-Conductive Baseplate
Base Material	: FR4 PCB (flammability to UL 94V-0 rated)
Pin Material	: Copper Alloy
Potting Material	: Epoxy (UL94-V0)
Weight	: 34g

**Heatsink (Option -HS)**

**Physical Characteristics**

Heatsink Material	: Aluminum
Finish	: Black Anodized Coating
Weight	: 9g

- ▶ The advantages of adding a heatsink are:
  1. To improve heat dissipation and increase the stability and reliability of the DC-DC converters at high operating temperatures.
  2. To increase operating temperature of the DC-DC converter, please refer to Derating Curve.

**External Output Trimming**

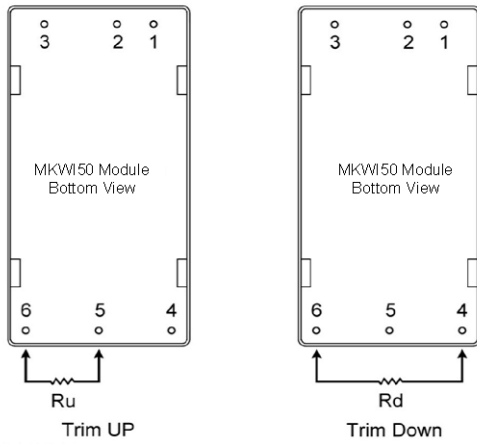
Output can be externally trimmed by using the method shown below



Trim Range (%)	MKWI50-XXS033		MKWI50-XXS05		MKWI50-XXS12		MKWI50-XXS15		MKWI50-XXS24	
	Trim down (kΩ)	Trim up (kΩ)	Trim down (kΩ)	Trim up (kΩ)	Trim down (kΩ)	Trim up (kΩ)	Trim down (kΩ)	Trim up (kΩ)	Trim down (kΩ)	Trim up (kΩ)
1	72.61	60.84	138.88	106.87	413.55	351.00	530.73	422.77	333.39	---
2	32.55	27.40	62.41	47.76	184.55	157.50	238.61	189.89	148.80	243.70
3	19.20	16.25	36.92	28.06	108.22	93.00	141.24	112.26	87.26	---
4	12.52	10.68	24.18	18.21	70.05	60.75	92.56	73.44	56.50	108.50
5	8.51	7.34	16.53	12.30	47.15	41.40	63.35	50.15	38.04	---
6	5.84	5.11	11.44	8.36	31.88	28.50	43.87	34.63	25.73	63.43
7	3.94	3.51	7.79	5.55	20.98	19.29	29.96	23.54	16.94	---
8	2.51	2.32	5.06	3.44	12.80	12.37	19.53	15.22	10.35	40.90
9	1.39	1.39	2.94	1.79	6.44	7.00	11.41	8.75	5.22	---
10	0.50	0.65	1.24	0.48	1.35	2.70	4.92	3.58	1.12	27.38
12	---	---	---	---	---	---	---	---	---	18.37
14	---	---	---	---	---	---	---	---	---	11.93
16	---	---	---	---	---	---	---	---	---	7.10
18	---	---	---	---	---	---	---	---	---	3.34
20	---	---	---	---	---	---	---	---	---	0.34

Order Code Table	
Standard	With heatsink
MKWI50-24S033	MKWI50-24S033-HS
MKWI50-24S05	MKWI50-24S05-HS
MKWI50-24S12	MKWI50-24S12-HS
MKWI50-24S15	MKWI50-24S15-HS
MKWI50-24S24	MKWI50-24S24-HS
MKWI50-48S033	MKWI50-48S033-HS
MKWI50-48S05	MKWI50-48S05-HS
MKWI50-48S12	MKWI50-48S12-HS
MKWI50-48S15	MKWI50-48S15-HS
MKWI50-48S24	MKWI50-48S24-HS

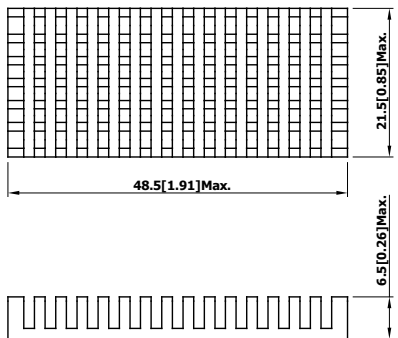
Order Code For Heatsink kit (including: Heatsink x1, Clamp x 2, Thermal Pad x1)
HS-K002

## Test Setup

### Input Reflected-Ripple Current Test Setup

Input reflected-ripple current is measured with an inductor  $L_{in}$  ( $4.7\mu\text{H}$ ) and  $C_{in}$  ( $220\mu\text{F}$ ,  $\text{ESR} < 1.0\Omega$  at  $100\text{ kHz}$ ) to simulate source impedance. Capacitor  $C_{in}$ , offsets possible battery impedance. Current ripple is measured at the input terminals of the module, measurement bandwidth is  $0\text{-}500\text{ kHz}$ .

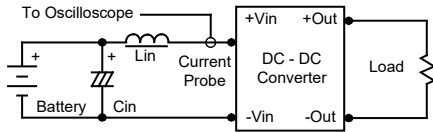

### Peak-to-Peak Output Noise Measurement Test

Refer to the output specifications or add  $4.7\mu\text{F}$  capacitor if the output specifications undefine  $C_{out}$ . Scope measurement should be made by using a BNC socket, measurement bandwidth is  $0\text{-}20\text{ MHz}$ . Position the load between  $50\text{ mm}$  and  $75\text{ mm}$  from the DC-DC Converter.

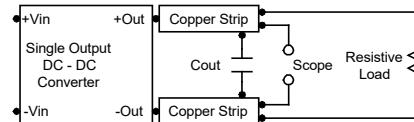

## Technical Notes

### Remote On/Off

Positive logic remote on/off turns the module on during a logic high voltage on the remote on/off pin, and off during a logic low. To turn the power module on and off, the user must supply a switch to control the voltage between the on/off terminal and the  $-V_{in}$  terminal. The switch can be an open collector or equivalent. A logic low is  $0\text{V}$  to  $1.2\text{V}$ . A logic high is  $3.5\text{V}$  to  $12\text{V}$ . The maximum sink current at the on/off terminal (Pin 3) during a logic low is  $-100\mu\text{A}$ .

### Overload Protection

To provide hiccup mode protection in a fault (output overload) condition, the unit is equipped with internal current limiting circuitry and can endure overload for an unlimited duration.

### Overvoltage Protection

The output overvoltage clamp consists of control circuitry, which is independent of the primary regulation loop, that monitors the voltage on the output terminals. The control loop of the clamp has a higher voltage set point than the primary loop. This provides a redundant voltage control that reduces the risk of output overvoltage. The OVP level can be found in the output data.

### Input Source Impedance

The power module should be connected to a low ac-impedance input source. Highly inductive source impedances can affect the stability of the power module. In applications where power is supplied over long lines and output loading is high, it may be necessary to use a capacitor at the input to ensure startup. Capacitor mounted close to the power module helps ensure stability of the unit, it is recommended to use a good quality low Equivalent Series Resistance ( $\text{ESR} < 1.0\Omega$  at  $100\text{ kHz}$ ) capacitor of a  $10\mu\text{F}$  for the  $24\text{V}$  and  $48\text{V}$  devices.

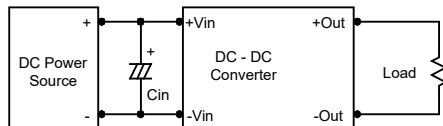

### Output Ripple Reduction

A good quality low ESR capacitor placed as close as practicable across the load will give the best ripple and noise performance. To reduce output ripple, it is recommended to use  $4.7\mu\text{F}$  capacitors at the output.

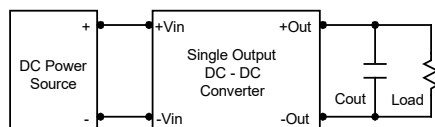

### Maximum Capacitive Load

The MKW150 series has limitation of maximum connected capacitance at the output. The power module may be operated in current limiting mode during start-up, affecting the ramp-up and the startup time. The maximum capacitance can be found in the data sheet.

### Thermal Considerations

Many conditions affect the thermal performance of the power module, such as orientation, airflow over the module and board spacing. To avoid exceeding the maximum temperature rating of the components inside the power module, the case temperature must be kept below  $105^\circ\text{C}$ . The derating curves are determined from measurements obtained in a test setup.

